

## LM78XX Series Voltage Regulators

### General Description

The LM78XX series of three terminal regulators is available with several fixed output voltages making them useful in a wide range of applications. One of these is local on card regulation, eliminating the distribution problems associated with single point regulation. The voltages available allow these regulators to be used in logic systems, instrumentation, HiFi, and other solid state electronic equipment. Although designed primarily as fixed voltage regulators these devices can be used with external components to obtain adjustable voltages and currents.

The LM78XX series is available in an aluminum TO-3 package which will allow over 1.0A load current if adequate heat sinking is provided. Current limiting is included to limit the peak output current to a safe value. Safe area protection for the output transistor is provided to limit internal power dissipation. If internal power dissipation becomes too high for the heat sinking provided, the thermal shutdown circuit takes over preventing the IC from overheating.

Considerable effort was expended to make the LM78XX series of regulators easy to use and minimize the number of external components. It is not necessary to bypass the out-

put, although this does improve transient response. Input bypassing is needed only if the regulator is located far from the filter capacitor of the power supply.

For output voltage other than 5V, 12V and 15V the LM117 series provides an output voltage range from 1.2V to 57V.

### Features

- Output current in excess of 1A
- Internal thermal overload protection
- No external components required
- Output transistor safe area protection
- Internal short circuit current limit
- Available in the aluminum TO-3 package

### Voltage Range

LM7805C	5V
LM7812C	12V
LM7815C	15V

### Connection Diagrams

**Metal Can Package  
TO-3 (K)  
Aluminum**

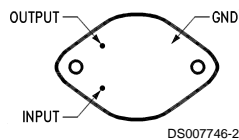

**Bottom View  
Order Number LM7805CK,  
LM7812CK or LM7815CK  
See NS Package Number KC02A**

**Plastic Package  
TO-220 (T)**

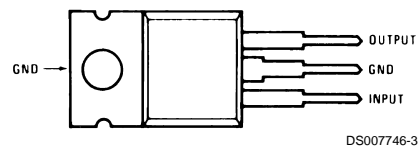

**Top View  
Order Number LM7805CT,  
LM7812CT or LM7815CT  
See NS Package Number T03B**

Schematic

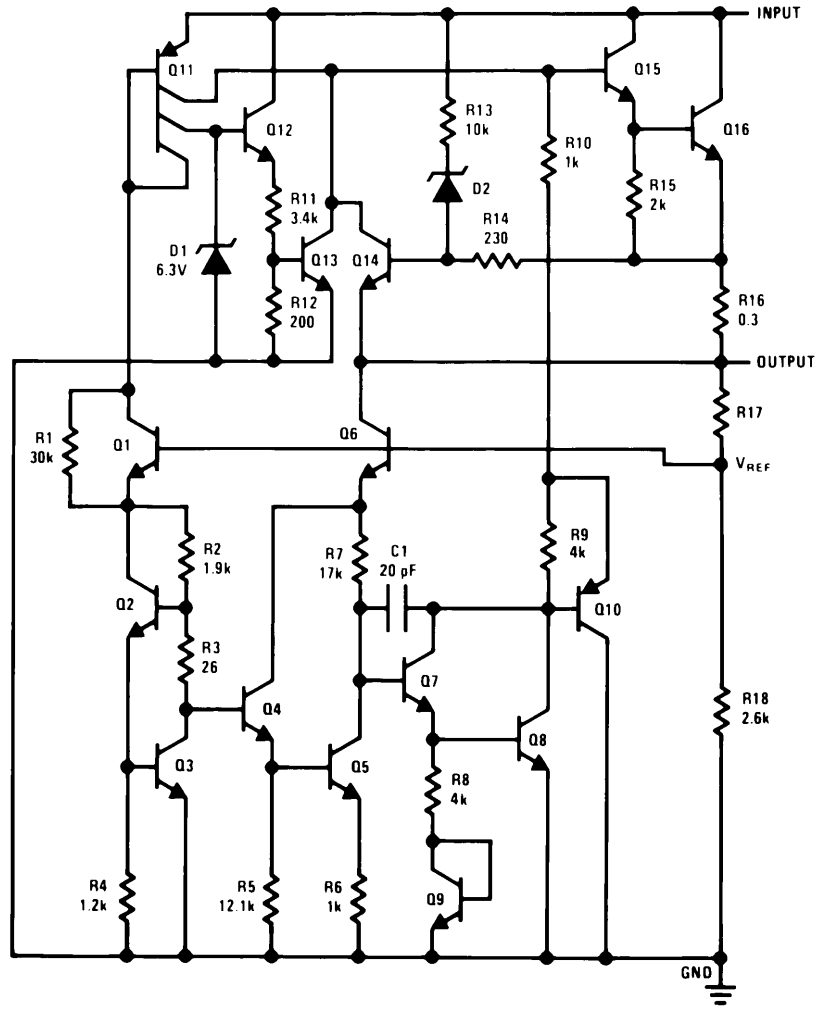

DS007746-1

**Absolute Maximum Ratings** (Note 3)

If Military/Aerospace specified devices are required, please contact the National Semiconductor Sales Office/Distributors for availability and specifications.

Input Voltage

 $(V_O = 5V, 12V \text{ and } 15V)$ 

35V

Internal Power Dissipation (Note 1)

Internally Limited

Operating Temperature Range ( $T_A$ )

0°C to +70°C

Maximum Junction Temperature

(K Package)

150°C

(T Package)

150°C

Storage Temperature Range

-65°C to +150°C

Lead Temperature (Soldering, 10 sec.)

TO-3 Package K

300°C

TO-220 Package T

230°C

**Electrical Characteristics LM78XXC** (Note 2)0°C ≤  $T_J$  ≤ 125°C unless otherwise noted.

Output Voltage			5V			12V			15V			Units
Input Voltage (unless otherwise noted)			10V			19V			23V			
Symbol	Parameter	Conditions	Min	Typ	Max	Min	Typ	Max	Min	Typ	Max	
$V_O$	Output Voltage	$T_J = 25^\circ\text{C}$ , $5 \text{ mA} \leq I_O \leq 1 \text{ A}$	4.8	5	5.2	11.5	12	12.5	14.4	15	15.6	V
		$P_D \leq 15\text{W}$ , $5 \text{ mA} \leq I_O \leq 1 \text{ A}$	4.75		5.25	11.4		12.6	14.25		15.75	V
		$V_{\text{MIN}} \leq V_{\text{IN}} \leq V_{\text{MAX}}$	(7.5 ≤ $V_{\text{IN}}$ ≤ 20)			(14.5 ≤ $V_{\text{IN}}$ ≤ 27)			(17.5 ≤ $V_{\text{IN}}$ ≤ 30)			V
$\Delta V_O$	Line Regulation	$I_O = 500 \text{ mA}$	$T_J = 25^\circ\text{C}$	3 50		4 120		4 150		mV		
			$\Delta V_{\text{IN}}$	(7 ≤ $V_{\text{IN}}$ ≤ 25)		14.5 ≤ $V_{\text{IN}}$ ≤ 30)		(17.5 ≤ $V_{\text{IN}}$ ≤ 30)		V		
		0°C ≤ $T_J$ ≤ +125°C	$\Delta V_{\text{IN}}$		50		120		150		mV	
			(8 ≤ $V_{\text{IN}}$ ≤ 20)		(15 ≤ $V_{\text{IN}}$ ≤ 27)		(18.5 ≤ $V_{\text{IN}}$ ≤ 30)			V		
		$I_O \leq 1 \text{ A}$	$T_J = 25^\circ\text{C}$	$\Delta V_{\text{IN}}$		50		120		150		mV
			(7.5 ≤ $V_{\text{IN}}$ ≤ 20)		(14.6 ≤ $V_{\text{IN}}$ ≤ 27)		(17.7 ≤ $V_{\text{IN}}$ ≤ 30)			V		
0°C ≤ $T_J$ ≤ +125°C	$\Delta V_{\text{IN}}$		25		60		75		mV			
	(8 ≤ $V_{\text{IN}}$ ≤ 12)		(16 ≤ $V_{\text{IN}}$ ≤ 22)		(20 ≤ $V_{\text{IN}}$ ≤ 26)			V				
$\Delta V_O$	Load Regulation	$T_J = 25^\circ\text{C}$	$5 \text{ mA} \leq I_O \leq 1.5 \text{ A}$	10 50		12 120		12 150		mV		
			$250 \text{ mA} \leq I_O \leq 750 \text{ mA}$	25		60		75		mV		
		$5 \text{ mA} \leq I_O \leq 1 \text{ A}$ , 0°C ≤ $T_J$ ≤ +125°C	50		120		150		mV			
$I_Q$	Quiescent Current	$I_O \leq 1 \text{ A}$	$T_J = 25^\circ\text{C}$	8		8		8		mA		
			0°C ≤ $T_J$ ≤ +125°C	8.5		8.5		8.5		mA		
$\Delta I_Q$	Quiescent Current Change	$5 \text{ mA} \leq I_O \leq 1 \text{ A}$		0.5		0.5		0.5		mA		
		$T_J = 25^\circ\text{C}$ , $I_O \leq 1 \text{ A}$	$V_{\text{MIN}} \leq V_{\text{IN}} \leq V_{\text{MAX}}$		1.0		1.0		1.0		mA	
			(7.5 ≤ $V_{\text{IN}}$ ≤ 20)		(14.8 ≤ $V_{\text{IN}}$ ≤ 27)		(17.9 ≤ $V_{\text{IN}}$ ≤ 30)			V		
0°C ≤ $T_J$ ≤ +125°C	$V_{\text{MIN}} \leq V_{\text{IN}} \leq V_{\text{MAX}}$		1.0		1.0		1.0		mA			
	(7 ≤ $V_{\text{IN}}$ ≤ 25)		(14.5 ≤ $V_{\text{IN}}$ ≤ 30)		(17.5 ≤ $V_{\text{IN}}$ ≤ 30)			V				
$V_N$	Output Noise Voltage	$T_A = 25^\circ\text{C}$ , 10 Hz ≤ $f$ ≤ 100 kHz		40		75		90		μV		
$\frac{\Delta V_{\text{IN}}}{\Delta V_{\text{OUT}}}$	Ripple Rejection	$f = 120 \text{ Hz}$	$I_O \leq 1 \text{ A}$ , $T_J = 25^\circ\text{C}$ or $I_O \leq 500 \text{ mA}$	62 80		55 72		54 70		dB		
			0°C ≤ $T_J$ ≤ +125°C	62		55		54		dB		
		$V_{\text{MIN}} \leq V_{\text{IN}} \leq V_{\text{MAX}}$		(8 ≤ $V_{\text{IN}}$ ≤ 18)		(15 ≤ $V_{\text{IN}}$ ≤ 25)		(18.5 ≤ $V_{\text{IN}}$ ≤ 28.5)		V		
$R_O$	Dropout Voltage	$T_J = 25^\circ\text{C}$ , $I_{\text{OUT}} = 1 \text{ A}$		2.0		2.0		2.0		V		
	Output Resistance	$f = 1 \text{ kHz}$		8		18		19		mΩ		

## Electrical Characteristics LM78XXC (Note 2) (Continued)

$0^{\circ}\text{C} \leq T_J \leq 125^{\circ}\text{C}$  unless otherwise noted.

Output Voltage			5V			12V			15V			Units
Input Voltage (unless otherwise noted)			10V			19V			23V			
Symbol	Parameter	Conditions	Min	Typ	Max	Min	Typ	Max	Min	Typ	Max	
	Short-Circuit Current	$T_J = 25^{\circ}\text{C}$	2.1			1.5			1.2			A
	Peak Output Current	$T_J = 25^{\circ}\text{C}$	2.4			2.4			2.4			A
	Average TC of $V_{\text{OUT}}$	$0^{\circ}\text{C} \leq T_J \leq +125^{\circ}\text{C}$ , $I_O = 5\text{ mA}$	0.6			1.5			1.8			mV/ $^{\circ}\text{C}$
$V_{\text{IN}}$	Input Voltage Required to Maintain Line Regulation	$T_J = 25^{\circ}\text{C}$ , $I_O \leq 1\text{A}$	7.5			14.6			17.7			V

**Note 1:** Thermal resistance of the TO-3 package (K, KC) is typically  $4^{\circ}\text{C/W}$  junction to case and  $35^{\circ}\text{C/W}$  case to ambient. Thermal resistance of the TO-220 package (T) is typically  $4^{\circ}\text{C/W}$  junction to case and  $50^{\circ}\text{C/W}$  case to ambient.

**Note 2:** All characteristics are measured with capacitor across the input of  $0.22\ \mu\text{F}$ , and a capacitor across the output of  $0.1\ \mu\text{F}$ . All characteristics except noise voltage and ripple rejection ratio are measured using pulse techniques ( $t_w \leq 10\text{ ms}$ , duty cycle  $\leq 5\%$ ). Output voltage changes due to changes in internal temperature must be taken into account separately.

**Note 3:** Absolute Maximum Ratings indicate limits beyond which damage to the device may occur. For guaranteed specifications and the test conditions, see Electrical Characteristics.

# Typical Performance Characteristics

Maximum Average Power Dissipation

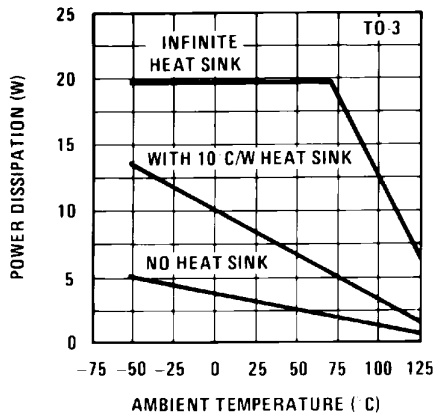

DS007746-5

Maximum Average Power Dissipation

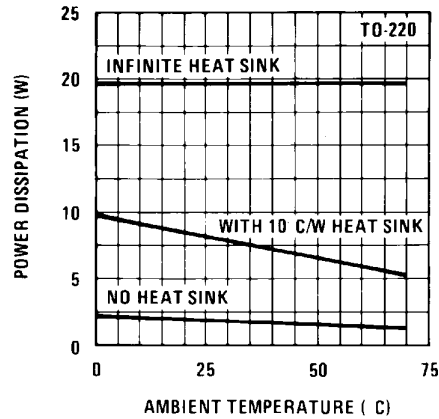

DS007746-6

Peak Output Current

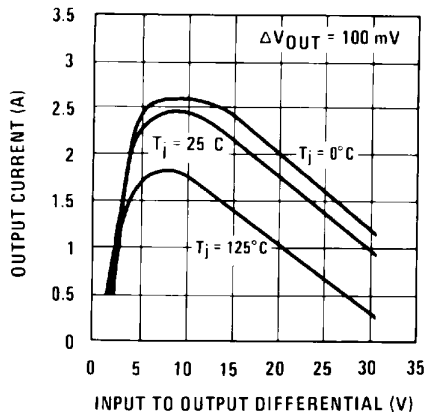

DS007746-7

Output Voltage (Normalized to 1V at Tj = 25°C)

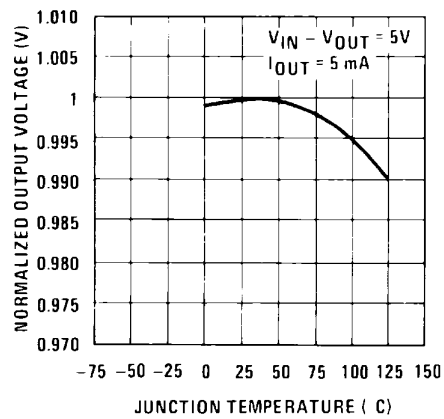

DS007746-8

Ripple Rejection

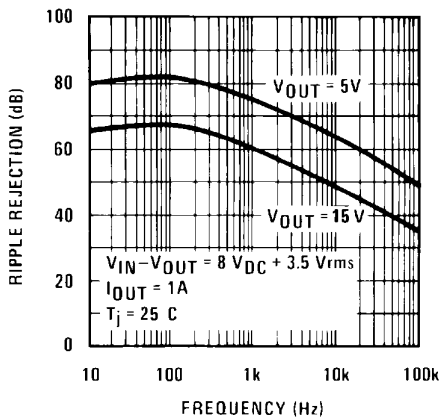

DS007746-9

Ripple Rejection

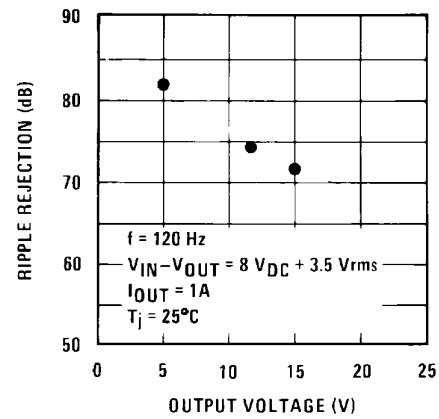

DS007746-10

# Typical Performance Characteristics (Continued)

Output Impedance

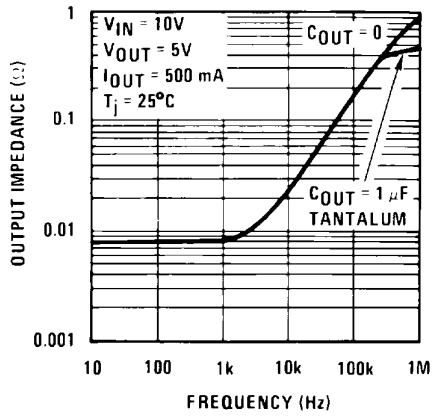

Dropout Voltage

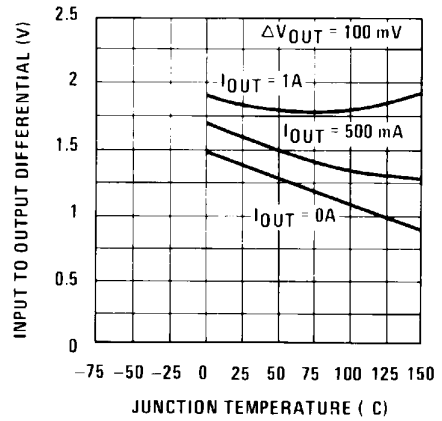

Dropout Characteristics

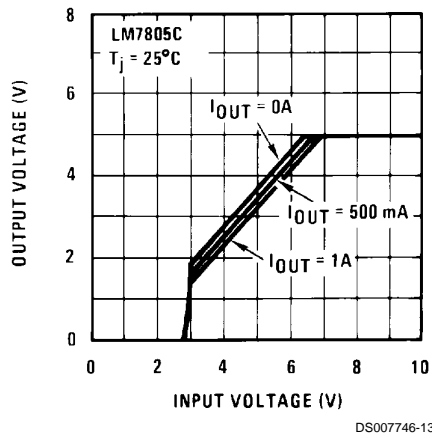

Quiescent Current

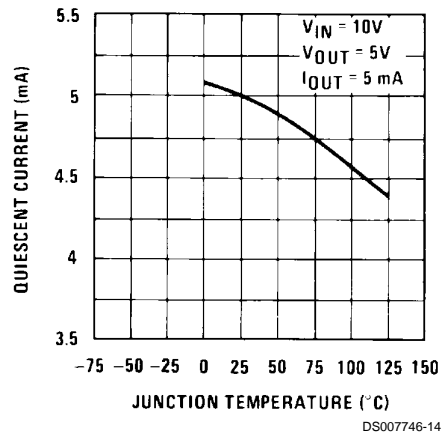

Quiescent Current

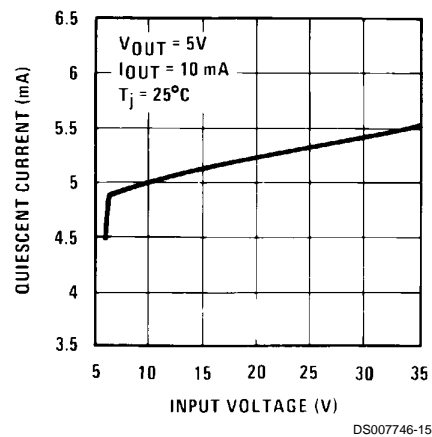

# Physical Dimensions inches (millimeters) unless otherwise noted

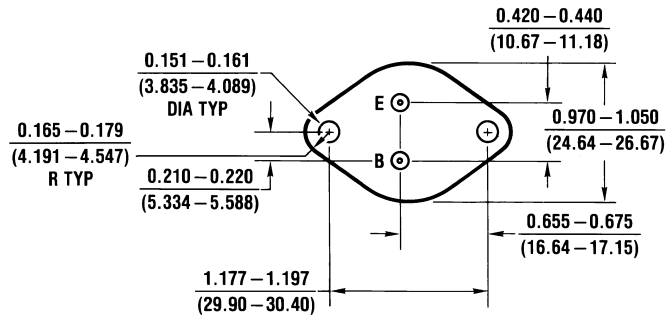
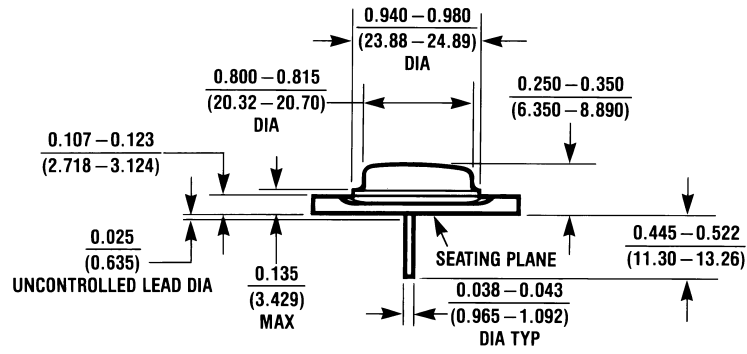

KC02A (REV C)

Aluminum Metal Can Package (KC)  
 Order Number LM7805CK, LM7812CK or LM7815CK  
 NS Package Number KC02A

**Physical Dimensions** inches (millimeters) unless otherwise noted (Continued)

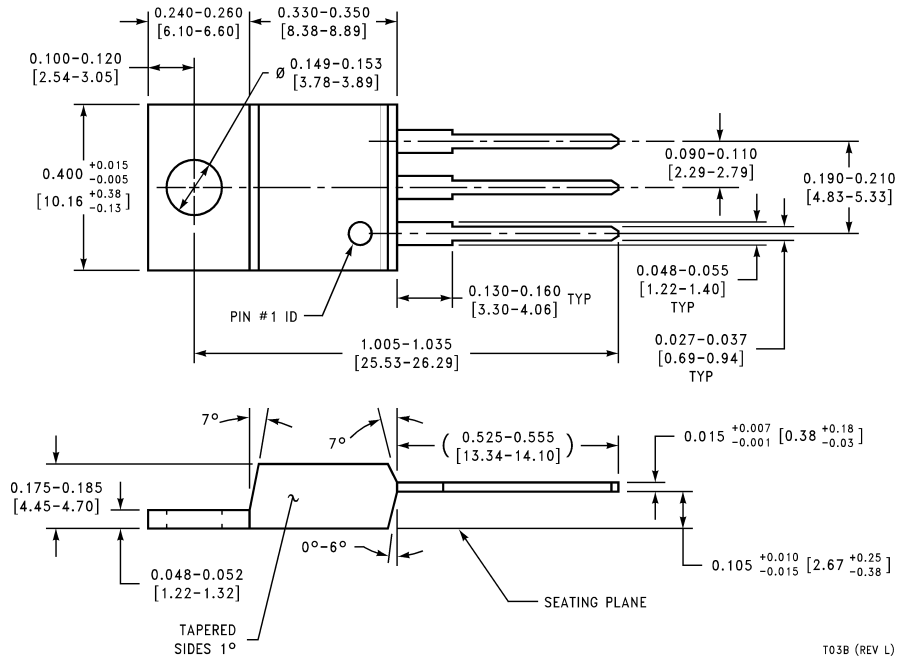

**TO-220 Package (T)**  
**Order Number LM7805CT, LM7812CT or LM7815CT**  
**NS Package Number T03B**

T03B (REV L)

**LIFE SUPPORT POLICY**

NATIONAL'S PRODUCTS ARE NOT AUTHORIZED FOR USE AS CRITICAL COMPONENTS IN LIFE SUPPORT DEVICES OR SYSTEMS WITHOUT THE EXPRESS WRITTEN APPROVAL OF THE PRESIDENT AND GENERAL COUNSEL OF NATIONAL SEMICONDUCTOR CORPORATION. As used herein:

1. Life support devices or systems are devices or systems which, (a) are intended for surgical implant into the body, or (b) support or sustain life, and whose failure to perform when properly used in accordance with instructions for use provided in the labeling, can be reasonably expected to result in a significant injury to the user.
2. A critical component is any component of a life support device or system whose failure to perform can be reasonably expected to cause the failure of the life support device or system, or to affect its safety or effectiveness.



**National Semiconductor Corporation**  
 Americas  
 Tel: 1-800-272-9959  
 Fax: 1-800-737-7018  
 Email: support@nsc.com  
 www.national.com

**National Semiconductor Europe**  
 Fax: +49 (0) 180-530 85 86  
 Email: europe.support@nsc.com  
 Deutsch Tel: +49 (0) 69 9508 6208  
 English Tel: +44 (0) 870 24 0 2171  
 Français Tel: +33 (0) 1 41 91 8790

**National Semiconductor Asia Pacific Customer Response Group**  
 Tel: 65-2544466  
 Fax: 65-2504466  
 Email: ap.support@nsc.com

**National Semiconductor Japan Ltd.**  
 Tel: 81-3-5639-7560  
 Fax: 81-3-5639-7507