

TEST REPORT EN 62133-2 Secondary cells and batteries containing alkaline or other non-acid electrolytes – Safety requirements for portable sealed secondary cells, and for batteries made from them, for use in portable applications – Part 2: Lithium systems	
Report Number.....	CMC230306034
Date of issue.....	2023-03-24
Total number of pages	27 pages
Tested by (name, signature)	Riley Xiao 
Reviewed by (name, signature)	Carol Xiong 
Approved by (name, signature)	Barry He 
Name of Testing Laboratory preparing the Report	CMC Testing International (Shenzhen) Co., Ltd
Address.....	101&104, Building B, Kaihuimao Industrial Park, Liyuan Road, Heping Community, Fuhai Street, Baoan District, Shenzhen, Guangdong, China
Applicant's name	GUANGDONG SHUNDE SUNSHINE ENERGY TECHNOLOGY.,LTD
Address.....	4F, Block B,Rising Sun Technology Industrial Park, No.6 Keyuan 3Rd,Ronggui Street,Shunde District, Foshan City, Guangdong Province,China
Manufacturer's name	GUANGDONG SHUNDE SUNSHINE ENERGY TECHNOLOGY.,LTD
Address.....	4F, Block B,Rising Sun Technology Industrial Park, No.6 Keyuan 3Rd,Ronggui Street,Shunde District, Foshan City, Guangdong Province,China
Test specification:	
Standard.....	EN 62133-2:2017, EN 62133-2:2017/AMD1:2021
Test procedure	Type approved
Non-standard test method	N/A
Test result	Pass
Test item description	Lithium-ion Battery
Trade Mark.....	N/A
Model/Type reference	604050
Ratings	7.4V, 1500mAh, 11.1Wh
General disclaimer:	
<p>The test results presented in this report relate only to the object tested. This report shall not be reproduced, except in full, without the written approval of the CMC. The authenticity of this Test Report and its contents can be verified by contacting the CMC, responsible for this Test Report.</p>	



<p>List of Attachments (including a total number of pages in each attachment): Attachment 1: Photo documentation (on pages 24-26).</p>	
<p>Summary of testing:</p>	
<p>Tests performed (name of test and test clause): cl.5.6.2 Design recommendation; cl.7.1 Charging procedure for test purposes (for Cells and Batteries); cl.7.2.1 Continuous charging at constant voltage (Cells); cl.7.2.2 Case stress at high ambient temperature (Batteries); cl.7.3.1 External short circuit (Cells); cl.7.3.2 External short circuit (Batteries); cl.7.3.3 Free fall (Cells and Batteries); cl.7.3.4 Thermal abuse (Cells); cl.7.3.5 Crush (Cells); cl.7.3.6 Over-charging of battery; cl.7.3.7 Forced discharge (Cells); cl.7.3.8 Mechanical tests (Batteries); cl.7.3.9 Design evaluation – Forced internal short circuit (Cells);</p> <p>Tests are made with the number of cells and batteries specified in EN 62133-2:2017, EN 62133-2:2017/AMD1:2021 Table 1.</p>	<p>Testing location: CMC Testing International (Shenzhen) Co., Ltd. 101&104, Building B, Kaihuimao Industrial Park, Liyuan Road, Heping Community, Fuhai Street, Baoan District, Shenzhen, Guangdong, China</p>
<p>Summary of compliance with National Differences: List of countries addressed:</p> <p><input checked="" type="checkbox"/> The product fulfils the requirements of: IEC 62133-2:2017, IEC 62133-2:2017/AMD1:2021.</p>	

Use of uncertainty of measurement for decisions on conformity (decision rule) :

No decision rule is specified by the IEC standard, when comparing the measurement result with the applicable limit according to the specification in that standard. The decisions on conformity are made without applying the measurement uncertainty ("simple acceptance" decision rule, previously known as "accuracy method").

Other: N/A (to be specified, for example when required by the standard or client, or if national accreditation requirements apply)

Information on uncertainty of measurement:

The uncertainties of measurement are calculated by the laboratory based on application of criteria given by OD-5014 for test equipment and application of test methods, decision sheets and operational procedures of IECEE.

IEC Guide 115 provides guidance on the application of measurement uncertainty principles and applying the decision rule when reporting test results within IECEE scheme, noting that the reporting of the measurement uncertainty for measurements is not necessary unless required by the test standard or customer.

Calculations leading to the reported values are on file with the NCB and testing laboratory that conducted the testing.

Copy of marking plate:

Red (+) Lithium-ion Battery
604050 1INP6/40/50
7.4V 1500mAh 11.1Wh
GUANGDONG SHUNDE SUNSHINE ENERGY TECHNOLOGY.,LTD
Black (-) YYYYMMDD Made in China
WARNING: Risk of Fire and Burns. Do Not Open, Crush, Heat Above 60°C/140°F or
Incinerate. Do not short circuit. If bulges severely, discontinue use. Follow
Manufacturer's Instructions.

Date Code: YYYYMMDD

YY=year, MM=month, DD=day

Test item particulars.....:	
Classification of installation and use	To be defined in final product
Supply Connection.....	DC Connector
Recommend charging method declared by the manufacturer	Charging the battery with 300mA constant current and 8.5V constant voltage until the current reduces to 15mA at ambient 20°C±5°C.
Discharge current (0,2 It A)	300mA
Specified final voltage.....	5.8V
Upper limit charging voltage per cell	4.3V
Maximum charging current.....	1500mA
Charging temperature upper limit.....	45°C
Charging temperature lower limit	0°C
Polymer cell electrolyte type.....	<input type="checkbox"/> gel polymer <input type="checkbox"/> solid polymer <input checked="" type="checkbox"/> N/A
Possible test case verdicts:	
- test case does not apply to the test object	N/A
- test object does meet the requirement	P (Pass)
- test object does not meet the requirement	F (Fail)
Testing.....:	
Date of receipt of test item.....	2023-03-14
Date (s) of performance of tests.....	2023-03-14 to 2023-03-24
Test Environment Condition	Ambient temperature: 22.8°C to 23.3°C
Sample identification.....	SN230306034C001~ SN230306034C053 SN230306034B001~ SN230306034B022
General remarks:	
<p>The test results presented in this report relate only to the object tested. This report shall not be reproduced, except in full, without the written approval of the Issuing testing laboratory. “(CXXX)” refers to sample number of cells, “X” is 0~9; “(BXXX)” refers to sample number of batteries, “X” is 0~9; “(See Enclosure)” refers to additional information appended to the report. “(See appended table)” refers to a table appended to the report.</p>	
Throughout this report a <input type="checkbox"/> comma / <input checked="" type="checkbox"/> point is used as the decimal separator.	
Name and address of factory (ies)	
: Same as applicant	

General product information and other remarks:

This battery is constructed with two lithium-ion cells (2S1P), and has overcharge, over-discharge, over current and short-circuits proof circuit.

The main features of the battery are shown as below (clause 7.1.1):

Model (Battery)	Nominal capacity	Nominal voltage	Nominal Charge Current	Nominal Discharge Current	Maximum Charge Current	Maximum Discharge Current	Maximum Charge Voltage	Final Voltage
604050	1500mAh	7.4V	300mA	300mA	1500mA	1500mA	8.5V	5.8

The main features of the cell in the battery are shown as below (clause 7.1.1):

Model (Cell)	Nominal capacity	Nominal voltage	Nominal Charge Current	Nominal Discharge Current	Maximum Charge Current	Maximum Discharge Current	Maximum Charge Voltage	Final Voltage
604050	1500mAh	3.7V	300mA	300mA	1500mA	1500mA	4.25V	2.75

The main features of the cell in the battery are shown as below (clause 7.1.2):

Model (Cell)	Upper limit charge voltage	Taper-off current	Lower charge temperature	Upper charge temperature
604050	4.3V	75mA	0°C	45°C

Construction

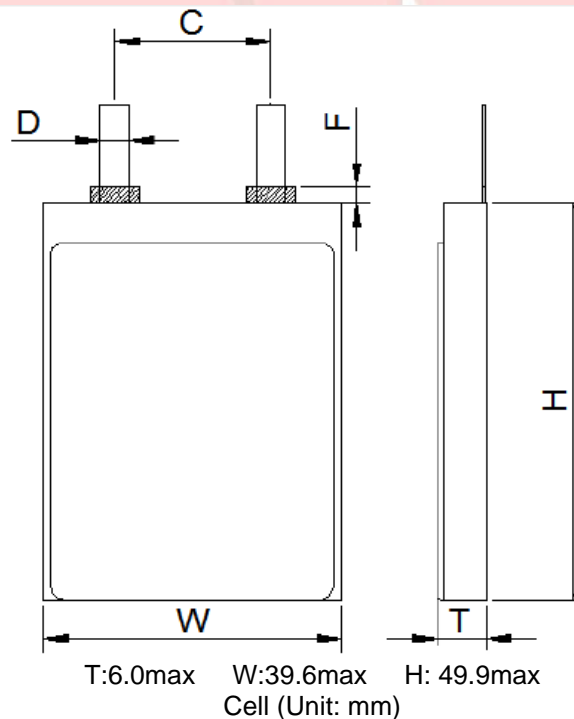

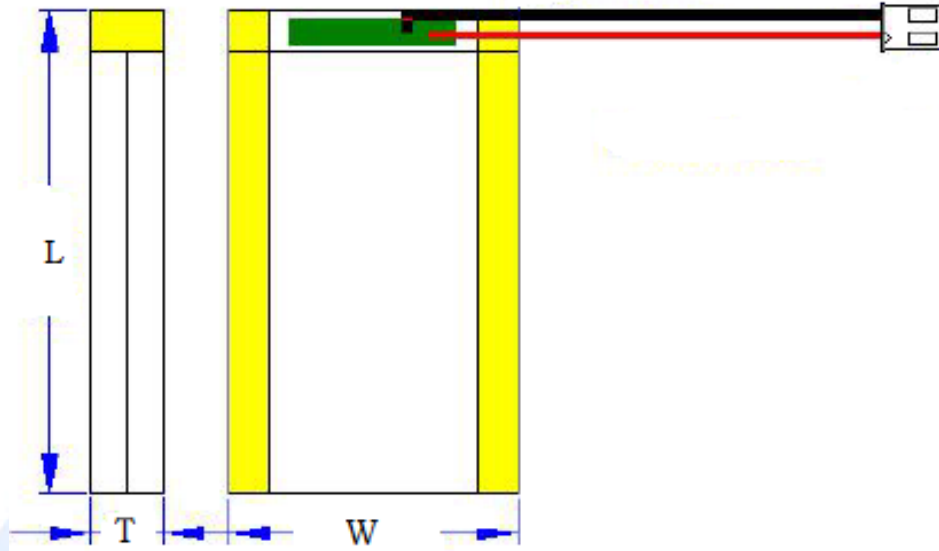

T:12.0max W:40.0max L: 51.0max
 Battery (Unit: mm)

Circuit diagram:

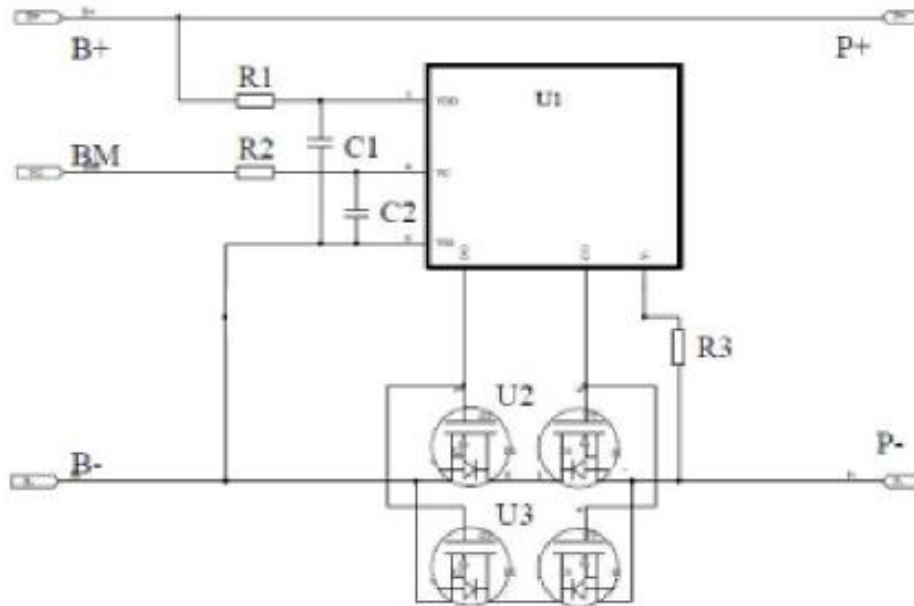

EN 62133-2			
Clause	Requirement + Test	Result - Remark	Verdict
4	PARAMETER MEASUREMENT TOLERANCES		P
	Parameter measurement tolerances		P
5	GENERAL SAFETY CONSIDERATIONS		P
5.1	General		P
	Cells and batteries so designed and constructed that they are safe under conditions of both intended use and reasonably foreseeable misuse		P
5.2	Insulation and wiring		P
	The insulation resistance between the positive terminal and externally exposed metal surfaces of the battery (excluding electrical contact surfaces) is not less than 5 MΩ	No metal surface exists.	N/A
	Insulation resistance (MΩ) :		—
	Internal wiring and insulation are sufficient to withstand maximum anticipated current, voltage and temperature requirements		P
	Orientation of wiring maintains adequate clearance and creepage distances between conductors		P
	Mechanical integrity of internal connections accommodates reasonably foreseeable misuse		P
5.3	Venting		P
	Battery cases and cells incorporate a pressure relief mechanism or are constructed so that they relieve excessive internal pressure at a value and rate that will preclude rupture, explosion and self-ignition	Venting mechanism exists on the narrow side of pouch cell.	P
	Encapsulation used to support cells within an outer casing does not cause the battery to overheat during normal operation nor inhibit pressure relief		N/A
5.4	Temperature, voltage and current management		P
	Batteries are designed such that abnormal temperature rise conditions are prevented	Overcharge, over discharge, over current and short-circuit proof circuit used in this battery. See tests of clause 7.	P
	Batteries are designed to be within temperature, voltage and current limits specified by the cell manufacturer	See above.	P
	Batteries are provided with specifications and charging instructions for equipment manufacturers so that specified chargers are designed to maintain charging within the temperature, voltage and current limits specified		P
5.5	Terminal contacts		P
	The size and shape of the terminal contacts ensure that they can carry the maximum anticipated current	DC Connector contacts complied with the requirements.	P

EN 62133-2			
Clause	Requirement + Test	Result - Remark	Verdict
	External terminal contact surfaces are formed from conductive materials with good mechanical strength and corrosion resistance	Complied.	P
	Terminal contacts are arranged to minimize the risk of short-circuit		P
5.6	Assembly of cells into batteries		P
5.6.1	General		P
	Each battery have an independent control and protection for current, voltage, temperature and any other parameter required for safety and to maintain the cells within their operating region	2S1P, Protective circuit equipped on battery.	P
	This protection may be provided external to the battery such as within the charger or the end devices		N/A
	If protection is external to the battery, the manufacturer of the battery provide this safety relevant information to the external device manufacturer for implementation		N/A
	If there is more than one battery housed in a single battery case, each battery have protective circuitry that can maintain the cells within their operating regions		N/A
	Manufacturers of cells specify current, voltage and temperature limits so that the battery manufacturer/designer may ensure proper design and assembly	Current, voltage and temperature limits specified by cell manufacturer.	P
	Batteries that are designed for the selective discharge of a portion of their series connected cells incorporate circuitry to prevent operation of cells outside the limits specified by the cell manufacturer		N/A
	Protective circuit components added as appropriate and consideration given to the end-device application		P
	The manufacturer of the battery provide a safety analysis of the battery safety circuitry with a test report including a fault analysis of the protection circuit under both charging and discharging conditions confirming the compliance		N/A
5.6.2	Design recommendation		P
	For the battery consisting of a single cell or a single cellblock, it is recommended that the charging voltage of the cell does not exceed the upper limit of the charging voltage specified in Table 2		N/A

EN 62133-2			
Clause	Requirement + Test	Result - Remark	Verdict
	For the battery consisting of series-connected plural single cells or series-connected plural cellblocks, it is recommended that the voltages of any one of the single cells or single cellblocks does not exceed the upper limit of the charging voltage, specified in Table 2, by monitoring the voltage of every single cell or the single cellblocks	2S1P, Max. charging voltage of cell: 4.25V, not exceed 4.30V specified in Table 2.	P
	For the battery consisting of series-connected plural single cells or series-connected plural cellblocks, it is recommended that charging is stopped when the upper limit of the charging voltage is exceeded for any one of the single cells or single cellblocks by measuring the voltage of every single cell or the single cellblocks		N/A
	For batteries consisting of series-connected cells or cell blocks, nominal charge voltage not be counted as an overcharge protection		P
	For batteries consisting of series-connected cells or cell blocks, cells have closely matched capacities, be of the same design, be of the same chemistry and be from the same manufacturer		P
	It is recommended that the cells and cell blocks not discharged beyond the cell manufacturer's specified final voltage	Final voltage of battery: 2.75V, not exceed the final voltage specified by cell manufacturer.	P
	For batteries consisting of series-connected cells or cell blocks, cell balancing circuitry incorporated into the battery management system		N/A
5.6.3	Mechanical protection for cells and components of batteries		P
	Mechanical protection for cells, cell connections and control circuits within the battery provided to prevent damage as a result of intended use and reasonably foreseeable misuse	Mechanical protection for cell connections and control circuits provided.	P
	The mechanical protection can be provided by the battery case or it can be provided by the end product enclosure for those batteries intended for building into an end product	Built-in batteries, mechanical protection for cells should be provided by end product.	N/A
	The battery case and compartments housing cells designed to accommodate cell dimensional tolerances during charging and discharging as recommended by the cell manufacturer	To be evaluated in final system.	N/A
	For batteries intended for building into a portable end product, testing with the battery installed within the end product considered when conducting mechanical tests		N/A
5.7	Quality plan		P

EN 62133-2			
Clause	Requirement + Test	Result - Remark	Verdict
	The manufacturer prepares and implements a quality plan that defines procedures for the inspection of materials, components, cells and batteries and which covers the whole process of producing each type of cell or battery	Complied. Quality plan provided.	P
5.8	Battery safety components	See TABLE: Critical components information	N/A
6	TYPE TEST AND SAMPLE SIZE		P
	Tests are made with the number of cells or batteries specified in Table 1 using cells or batteries that are not more than six months old		P
	Coin cells with resistance $\leq 3 \Omega$ (measured according annex D) are tested according table 1	Not coin cells	N/A
	Unless otherwise specified, tests are carried out in an ambient temperature of $20 \text{ }^\circ\text{C} \pm 5 \text{ }^\circ\text{C}$		P
	The safety analysis of 5.6.1 identify those components of the protection circuit that are critical for short-circuit, overcharge and overdischarge protection		P
	When conducting the short-circuit test, consideration given to the simulation of any single fault condition that is likely to occur in the protecting circuit that would affect the short-circuit test	See clause 7.3.2.	P
7	SPECIFIC REQUIREMENTS AND TESTS		P
7.1	Charging procedure for test purposes		P
7.1.1	First procedure		P
	This charging procedure applies to subclauses other than those specified in 7.1.2		P
	Unless otherwise stated in this document, the charging procedure for test purposes is carried out in an ambient temperature of $20 \text{ }^\circ\text{C} \pm 5 \text{ }^\circ\text{C}$, using the method declared by the manufacturer		P
	Prior to charging, the battery have been discharged at $20 \text{ }^\circ\text{C} \pm 5 \text{ }^\circ\text{C}$ at a constant current of 0,2 It A down to a specified final voltage		P
7.1.2	Second procedure		P
	This charging procedure applies only to 7.3.1, 7.3.4, 7.3.5, and 7.3.9		P
	After stabilization for 1 h and 4 h, respectively, at ambient temperature of highest test temperature and lowest test temperature, as specified in Table 2, cells are charged by using the upper limit charging voltage and maximum charging current, until the charging current is reduced to 0,05 It A, using a constant voltage charging method	Charge temperature specified by manufacturer: 0-45°C. 0°C used for lower limit tests. 45°C used for upper limit tests.	P

EN 62133-2			
Clause	Requirement + Test	Result - Remark	Verdict
7.2	Intended use		P
7.2.1	Continuous charging at constant voltage (cells)	Tested complied.	P
	Fully charged cells are subjected for 7 days to a charge using the charging method for current and standard voltage specified by the cell manufacturer	Charging for 7 days with 300mA.	P
	Results: No fire. No explosion. No leakage..... :	(See appended table 7.2.1)	P
7.2.2	Case stress at high ambient temperature (battery)	Test as request by client	P
	Oven temperature (°C)..... :	70°C	—
	Results: No physical distortion of the battery case resulting in exposure of internal protective components and cells	No physical distortion of the battery casing.	P
7.3	Reasonably foreseeable misuse		P
7.3.1	External short-circuit (cell)	Tested complied.	P
	The cells were tested until one of the following occurred:		P
	- 24 hours elapsed; or		N/A
	- The case temperature declined by 20 % of the maximum temperature rise		P
	Results: No fire. No explosion..... :	(See appended table 7.3.1)	P
7.3.2	External short-circuit (battery)	Tested complied.	P
	The batteries were tested until one of the following occurred:		P
	- 24 hours elapsed; or		N/A
	- The case temperature declined by 20 % of the maximum temperature rise		P
	In case of rapid decline in short circuit current, the battery pack remained on test for an additional one hour after the current reached a low end steady state condition		P
	A single fault in the discharge protection circuit conducted on one to four (depending upon the protection circuit) of the five samples before conducting the short-circuit test	Single fault conducted on three samples.	P
	A single fault applies to protective component parts such as MOSFET, fuse, thermostat or positive temperature coefficient (PTC) thermistor	Single fault applies on MOSFET (U2)	P
	Results: No fire. No explosion..... :	(See appended table 7.3.2)	P
7.3.3	Free fall	Tested complied.	P
	Results: No fire. No explosion	No fire. No explosion.	P
7.3.4	Thermal abuse (cells)	Tested complied.	P
	Oven temperature (°C)..... :	130°C	—
	Results: No fire. No explosion	No fire. No explosion.	P



EN 62133-2			
Clause	Requirement + Test	Result - Remark	Verdict
7.3.5	Crush (cells)	Tested complied.	P
	The crushing force was released upon:		P
	- The maximum force of 13 kN ± 0,78 kN has been applied; or		P
	- An abrupt voltage drop of one-third of the original voltage has been obtained		N/A
	Results: No fire. No explosion..... :	(See appended table 7.3.5)	P
7.3.6	Over-charging of battery	Tested complied.	P
	The supply voltage which is:		P
	- 1,4 times the upper limit charging voltage presented in Table A.1 (but not to exceed 6,0 V) for single cell/cell block batteries or		N/A
	- 1,2 times the upper limit charging voltage resented in Table A.1 per cell for series connected multi-cell batteries, and	10.32V applied.	P
	- Sufficient to maintain a current of 2,0 It A throughout the duration of the test or until the supply voltage is reached		P
	Test was continued until the temperature of the outer casing:		P
	- Reached steady state conditions (less than 10 °C change in 30-minute period); or		N/A
	- Returned to ambient		P
	Results: No fire. No explosion..... :	(See appended table 7.3.6)	P
7.3.7	Forced discharge (cells)	Tested complied.	P
	Discharge a single cell to the lower limit discharge voltage specified by the cell manufacturer	Lower limit discharge voltage 2.75V	P
	The discharged cell is then subjected to a forced discharge at 1 It A to the negative value of the upper limit charging voltage		P
	- The discharge voltage reaches the negative value of upper limit charging voltage within the testing duration. The voltage is maintained at the negative value of the upper limit charging voltage by reducing the current for the remainder of the testing duration		N/A
	- The discharge voltage does not reach the negative value of upper limit charging voltage within the testing duration. The test is terminated at the end of the testing duration		P
	Results: No fire. No explosion..... :	(See appended table 7.3.7)	P
7.3.8	Mechanical tests (batteries)		P
7.3.8.1	Vibration	Tested complied.	P
	Results: No fire, no explosion, no rupture, no leakage or venting. :	(See appended table 7.3.8.1)	P

EN 62133-2			
Clause	Requirement + Test	Result - Remark	Verdict
7.3.8.2	Mechanical shock	Tested complied.	P
	Results: No leakage, no venting, no rupture, no explosion and no fire	(See appended table 7.3.8.2)	P
7.3.9	Design evaluation – Forced internal short-circuit (cells)	Tested complied.	P
	The cells complied with national requirement for	France, Japan, Republic of Korea and Switzerland.	—
	The pressing was stopped upon:		P
	- A voltage drop of 50 mV has been detected; or		N/A
	- The pressing force of 800 N (cylindrical cells) or 400 N (prismatic cells) has been reached	400N for prismatic cell.	P
	Results: No fire	(See appended table 7.3.9)	P
8	INFORMATION FOR SAFETY		P
8.1	General		P
	Manufacturers of secondary cells provides information about current, voltage and temperature limits of their products	Information for safety mentioned in manufacturer's specifications.	P
	Manufacturers of batteries provides information regarding how to minimize and mitigate hazards to equipment manufacturers or end-users	Information for safety mentioned in manufacturer's specifications.	P
	Systems analyses are performed by device manufacturers to ensure that a particular battery design prevents hazards from occurring during use of a product		N/A
	As appropriate, any information relating to hazard avoidance resulting from a system analysis is provided to the end user		N/A
8.2	Small cell and battery safety information		N/A
	The following warning language is to be provided with the information packaged with the small cells and batteries or equipment using them:		N/A
	- Keep small cells and batteries which are considered swallowable out of the reach of children		N/A
	- Swallowing may lead to burns, perforation of soft tissue, and death. Severe burns can occur within 2 h of ingestion		N/A
	- In case of ingestion of a cell or battery, seek medical assistance promptly		N/A
9	MARKING		P
9.1	Cell marking		N/A
	Cells marked as specified in IEC 61960, except coin cells	The final product is battery	N/A
			N/A

EN 62133-2			
Clause	Requirement + Test	Result - Remark	Verdict
	Coin cells whose external surface area is too small to accommodate the markings on the cells show the designation and polarity		N/A
	By agreement between the cell manufacturer and the battery and/or end product manufacturer, component cells used in the manufacture of a battery need not be marked		N/A
9.2	Battery marking		P
	Batteries are marked as specified in IEC 61960, except for coin batteries	See marking plate.	P
	Coin batteries whose external surface area is too small to accommodate the markings on the batteries show the designation and polarity	Not coin batteries.	N/A
	Batteries are marked with an appropriate caution statement	Batteries marked with an appropriate caution statement.	P
	- Terminals have clear polarity marking on the external surface of the battery, or		N/A
	- Not be marked with polarity markings if the design of the external connector prevents reverse polarity connections		P
9.3	Caution for ingestion of small cells and batteries		N/A
	Coin cells and batteries identified as small batteries according to 8.2 include a caution statement regarding the hazards of ingestion in accordance with 8.2	Not coin cells and batteries.	N/A
	Small cells and batteries are intended for direct sale in consumer-replaceable applications, caution for ingestion is given on the immediate package	Not intended for direct sale.	N/A
9.4	Other information		P
	The following information are marked on or supplied with the battery:	Information for storage and disposal instructions mentioned in manufacturer's specifications.	P
	- Storage and disposal instructions		P
	- Recommended charging instructions		P
10	PACKAGING AND TRANSPORT		N/A
	Packaging for coin cells are not be small enough to fit within the limits of the ingestion gauge of Figure 3	Not coin cells.	N/A

EN 62133-2			
Clause	Requirement + Test	Result - Remark	Verdict
ANNEX A	CHARGING AND DISCHARGING RANGE OF SECONDARY LITHIUM ION CELLS FOR SAFE USE		P
A.1	General		P
A.2	Safety of lithium ion secondary battery	Complied.	P
A.3	Consideration on charging voltage	Complied.	P
A.3.1	General		P
A.3.2	Upper limit charging voltage	4.3V applied.	P
A.3.2.1	General		P
A.3.2.2	Explanation of safety viewpoint		P
A.3.2.3	Safety requirements, when different upper limit charging voltage is applied	4.3V applied.	P
A.4	Consideration of temperature and charging current		P
A.4.1	General		P
A.4.2	Recommended temperature range	See A.4.2.2.	P
A.4.2.1	General		P
A.4.2.2	Safety consideration when a different recommended temperature range is applied	Charging temperature declared by client is: 0-45°C.	N/A
A.4.3	High temperature range	Not higher than the temperature specific in this standard.	N/A
A.4.3.1	General		N/A
A.4.3.2	Explanation of safety viewpoint		N/A
A.4.3.3	Safety considerations when specifying charging conditions in the high temperature range		N/A
A.4.3.4	Safety considerations when specifying a new upper limit in the high temperature range		N/A
A.4.4	Low temperature range	Not lower than the temperature specific in this standard.	N/A
A.4.4.1	General		N/A
A.4.4.2	Explanation of safety viewpoint		N/A
A.4.4.3	Safety considerations, when specifying charging conditions in the low temperature range		N/A
A.4.4.4	Safety considerations when specifying a new lower limit in the low temperature range		N/A
A.4.5	Scope of the application of charging current		P
A.4.6	Consideration of discharge		P
A.4.6.1	General		P
A.4.6.2	Final discharge voltage and explanation of safety viewpoint	Cell specified final voltage 2.75V, not exceed 2.75V specified by cell manufacturer.	P

EN 62133-2			
Clause	Requirement + Test	Result - Remark	Verdict
A.4.6.3	Discharge current and temperature range		P
A.4.6.4	Scope of application of the discharging current		P
A.5	Sample preparation		P
A.5.1	General		P
A.5.2	Insertion procedure for nickel particle to generate internal short		P
A.5.3	Disassembly of charged cell		P
A.5.4	Shape of nickel particle		P
A.5.5	Insertion of nickel particle in cylindrical cell		N/A
A.5.5.1	Insertion of nickel particle in winding core		N/A
A.5.5.2	Marking the position of the nickel particle on both ends of the winding core of the separator		N/A
A.5.6	Insertion of nickel particle in prismatic cell		P
A.6	Experimental procedure of the forced internal short-circuit test		P
A.6.1	Material and tools for preparation of nickel particle		P
A.6.2	Example of a nickel particle preparation procedure		P
A.6.3	Positioning (or placement) of a nickel particle		P
A.6.4	Damaged separator precaution		P
A.6.5	Caution for rewinding separator and electrode		P
A.6.6	Insulation film for preventing short-circuit		P
A.6.7	Caution when disassembling a cell		P
A.6.8	Protective equipment for safety		P
A.6.9	Caution in the case of fire during disassembling		P
A.6.10	Caution for the disassembling process and pressing the electrode core		P
A.6.11	Recommended specifications for the pressing device		P
ANNEX B	RECOMMENDATIONS TO EQUIPMENT MANUFACTURERS AND BATTERY ASSEMBLERS		N/A
ANNEX C	RECOMMENDATIONS TO THE END-USERS		N/A
ANNEX D	MEASUREMENT OF THE INTERNAL AC RESISTANCE FOR COIN CELLS		N/A
D.1	General	Not coin cells.	N/A
D.2	Method		N/A
	A sample size of three coin cells is required for this measurement		N/A

EN 62133-2			
Clause	Requirement + Test	Result - Remark	Verdict
	Coin cells with an internal resistance greater than 3 Ω require no further testing	(See appended table D.2)	N/A
	Coin cells with an internal resistance less than or equal to 3 Ω are subjected to the testing according to Clause 6 and Table 1		N/A
ANNEX E	PACKAGING AND TRANSPORT		N/A
ANNEX F	COMPONENT STANDARDS REFERENCES		N/A

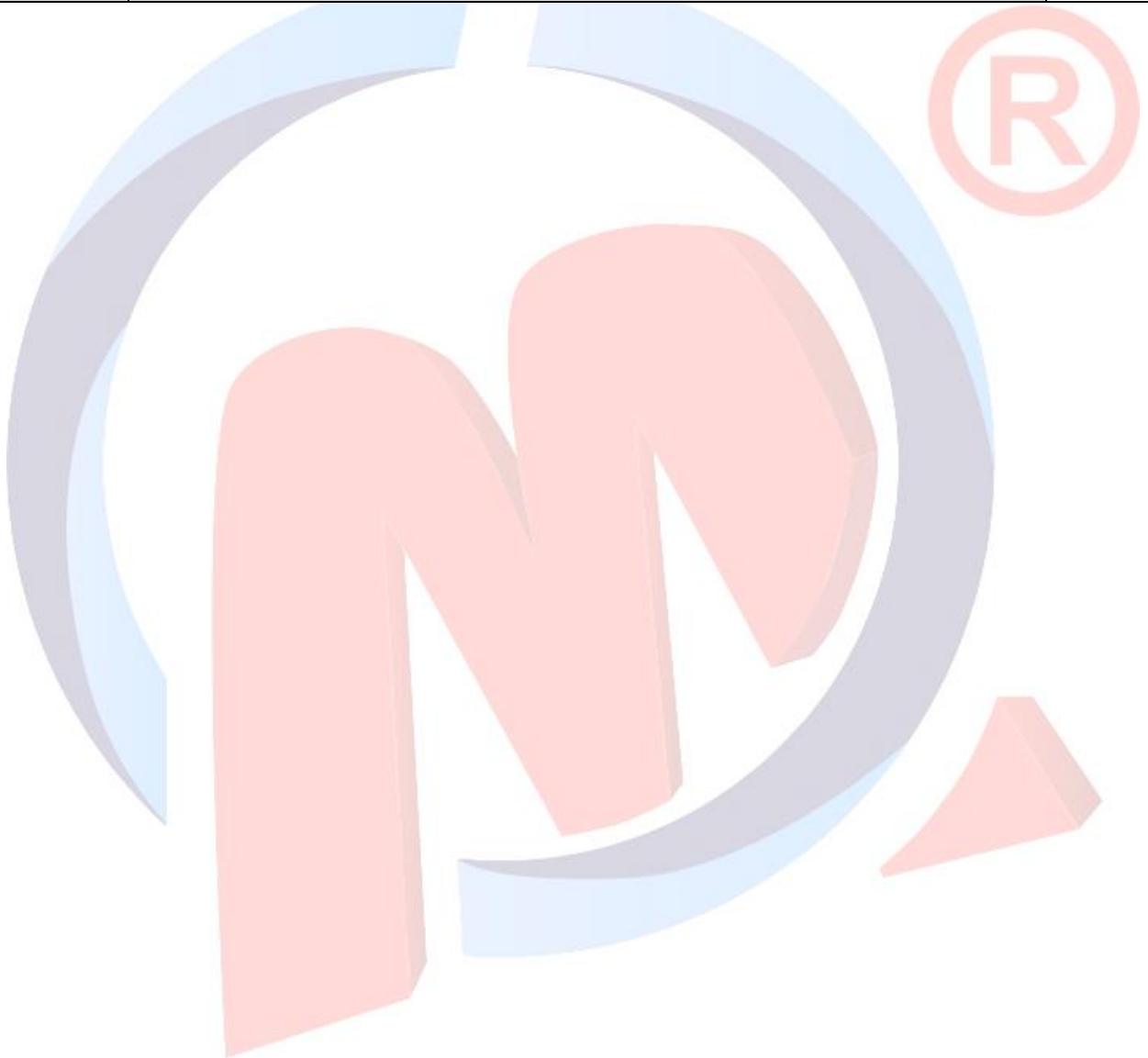



TABLE: Critical components information					P
Object / part No.	Manufacturer / trademark	Type / model	Technical data	Standard	Mark(s) of conformity ¹⁾
Cell	ShenzhenLixiangyuan TechnoloCo.,LTD	604050	3.7V, 1500mAh, 11.1Wh	EN 62133-2:2017, EN 62133-2:2017/A MD1:2021	Tested with appliance
-Positive electrode	Yunnan shengbihe New Material Co., Ltd	SS-N532A1	Li(Ni _{0.5} Co _{0.2} Mn _{0.3})O ₂ , NMP, PVDF,Conductive, Additive,Aluminum foil	--	--
-Negative electrode	Shenzhen Kingrunning Energy Materials Co.Ltd.	5A	Graphite, CMC,SBR,Conductive, Additive, Copper foil	--	--
-Electrolyte	Shenzhen poly treasure of the plastic material co., LTD	DJ1006A	LiPF6, EC, DEC, EMC	--	--
-Separator	Hunan Dajing New Material Co.,Ltd	9+3μm	Al ₂ O ₃ +PE, Shutdown temperature: 130°C	--	--
PCB	SHENZHEN CITY JIAWANTONGDA CIRCUIT CO LTD	JWTD-M	V-0, 130°C	UL 796 UL 94	UL E492187
PCB (Alternative)	Interchangeable	Interchangeable	V-0, 130°C	UL 796 UL 94	UL approved
Protective IC (U1)	HYCON Technology Corp.	HY-2120CB	V _{CU} = 4.28V±0.05V V _{DL} = 2.9V±0.08V	--	Tested with appliance
MOSFET (U2, U3)	Shenzhen Developer Microelectronics Co., Ltd.	8205A	V _{DS} =20V, V _{GS} =±12V, I _b (Ta=25°C) =5A	--	Tested with appliance
Lead wire	ZHONGSHAN YIXIN ELECTRICAL CO LTD	1007	24AWG, 80°C, 30Vac	UL 758	UL E351034
Lead wire (Alternative)	Interchangeable	Interchangeable	24AWG, 80°C, 30Vac	UL 758	UL approved
DC Connector	Interchangeable	Interchangeable	2Pins	UL 1977	UL approved
Supplementary information: ¹⁾ Provided evidence ensures the agreed level of compliance.					

7.2.1	TABLE: Continuous charging at constant voltage (cells)				P
Sample no.	Recommended charging voltage Vc (Vdc)	Recommended charging current I _{rec} (A)	OCV before test (Vdc)	Results	
SN230306034C001	4.25	0.3	4.25	P	
SN230306034C002	4.25	0.3	4.25	P	
SN230306034C003	4.25	0.3	4.25	P	
SN230306034C004	4.25	0.3	4.25	P	
SN230306034C005	4.25	0.3	4.25	P	
Supplementary information:					
- No fire or explosion					
- No leakage					

7.3.1	TABLE: External short-circuit (cell)					P
Sample no.	Ambient T (°C)	OCV before test (Vdc)	Resistance of circuit (mΩ)	Maximum case temperature rise ΔT, °C	Results	
Samples charged at charging temperature upper limit (45°C)						
SN230306034C006	56.1	4.21	87	108.2	P	
SN230306034C007	56.1	4.22	88	109.1	P	
SN230306034C008	56.1	4.22	84	109.8	P	
SN230306034C009	56.1	4.21	85	108.9	P	
SN230306034C010	56.1	4.21	83	109.6	P	
Samples charged at charging temperature lower limit (0°C)						
SN230306034C011	55.9	4.18	87	109.4	P	
SN230306034C012	55.9	4.17	85	109.7	P	
SN230306034C013	55.9	4.18	87	108.8	P	
SN230306034C014	55.9	4.17	85	109.2	P	
SN230306034C015	55.9	4.17	86	109.5	P	
Supplementary information:						
-No fire or explosion						

7.3.2	TABLE: External short-circuit (battery)					P
Sample no.	Ambient T (°C)	OCV before test (Vdc)	Resistance of circuit (mΩ)	Maximum case temperature rise ΔT , °C	Component single fault condition	Results
SN230306034B004	22.8	8.46	84	109.5	Short circuit MOSFET (U2)	P
SN230306034B005	22.8	8.45	85	109.7	Short circuit MOSFET (U2)	P
SN230306034B006	22.8	8.46	87	109.0	Short circuit MOSFET (U2)	P
SN230306034B007	22.8	8.45	86	23.1	--	P
SN230306034B008	22.8	8.46	82	23.0	--	P
Supplementary information:						
- No fire or explosion						

7.3.5	TABLE: Crush (cells)				P
Sample no.	OCV before test (Vdc)	OCV at removal of crushing force (Vdc)	Maximum force applied to the cell during crush (kN)	Results	
Samples charged at charging temperature upper limit (45°C)					
SN230306034C029	4.21	4.21	13.00	P	
SN230306034C030	4.22	4.22	13.01	P	
SN230306034C031	4.21	4.21	13.03	P	
SN230306034C032	4.21	4.21	13.02	P	
SN230306034C033	4.21	4.21	13.01	P	
Samples charged at charging temperature lower limit (0°C)					
SN230306034C034	4.18	4.18	13.00	P	
SN230306034C035	4.17	4.17	13.02	P	
SN230306034C036	4.17	4.17	13.03	P	
SN230306034C037	4.18	4.18	13.01	P	
SN230306034C038	4.17	4.17	13.01	P	
Note: A 13kN force applied at the wide side of prismatic cells. No voltage abrupt drop occurred.					
Supplementary information:					
- No fire or explosion					



7.3.6	TABLE: Over-charging of battery				P
Constant charging current (A)		3.0		—	
Supply voltage (Vdc)		10.32		—	
Sample no.	OCV before charging (Vdc)	Total charging time (minute)	Maximum outer case temperature (°C)	Results	
SN230306034B012	6.01	100	34.8	P	
SN230306034B013	6.02	100	35.0	P	
SN230306034B014	6.00	100	34.9	P	
SN230306034B015	6.01	100	35.1	P	
SN230306034B016	6.02	100	34.7	P	
Supplementary information:					
- No fire or explosion					

7.3.7	TABLE: Forced discharge (cells)				P
Sample no.	OCV before application of reverse charge (Vdc)	Measured reverse charge I_t (A)	Lower limit discharge voltage (Vdc)	Results	
SN230306034C039	3.02	1.5	2.75	P	
SN230306034C040	3.00	1.5	2.75	P	
SN230306034C041	3.01	1.5	2.75	P	
SN230306034C042	3.02	1.5	2.75	P	
SN230306034C043	3.01	1.5	2.75	P	
Supplementary information:					
- No fire or explosion					



7.3.8.1 TABLE: Vibration					P
Sample no.	OCV before test (Vdc)	OCV after test (Vdc)	Mass before test (g)	Mass after test (g)	Results
SN230306034B 017	8.45	8.45	51.116	51.110	P
SN230306034B 018	8.46	8.46	51.112	51.108	P
SN230306034B 019	8.45	8.45	51.114	51.109	P

Supplementary information:

- No fire or explosion
- No rupture
- No leakage
- No venting

7.3.8.2 TABLE: Mechanical shock					P
Sample no.	OCV before test (Vdc)	OCV after test (Vdc)	Mass before test (g)	Mass after test (g)	Results
SN230306034B 020	8.45	8.45	51.112	51.111	P
SN230306034B 021	8.46	8.46	51.108	51.107	P
SN230306034B 022	8.46	8.46	51.117	51.115	P

Supplementary information:

- No fire or explosion
- No rupture
- No leakage
- No venting

7.3.9	TABLE: Forced internal short circuit (cells)					P
Sample no.	Chamber ambient T (°C)	OCV before test (Vdc)	Particle location ¹⁾	Maximum applied pressure (N)	Results	
Samples charged at charging temperature upper limit (45°C)						
SN230306034C 044	45.0	4.21	1	400	P	
SN230306034C 045	45.0	4.22	1	400	P	
SN230306034C 046	45.0	4.21	1	400	P	
SN230306034C 047	45.0	4.21	1	400	P	
SN230306034C 048	45.0	4.21	1	400	P	
Samples charged at charging temperature lower limit (0°C)						
SN230306034C 049	0	4.17	1	400	P	
SN230306034C 050	0	4.18	1	400	P	
SN230306034C 051	0	4.17	1	400	P	
SN230306034C 052	0	4.18	1	400	P	
SN230306034C 053	0	4.17	1	400	P	
Supplementary information:						
¹⁾ Identify one of the following: 1: Nickel particle inserted between positive and negative (active material) coated area. 2: Nickel particle inserted between positive aluminium foil and negative active material coated area. - No fire or explosion						

D.2	TABLE: Internal AC resistance for coin cells				N/A
Sample no.	Ambient T (°C)	Store time (h)	Resistance Rac (Ω)	Results ¹⁾	
Supplementary information:					

Attachment 1: Photo documentation

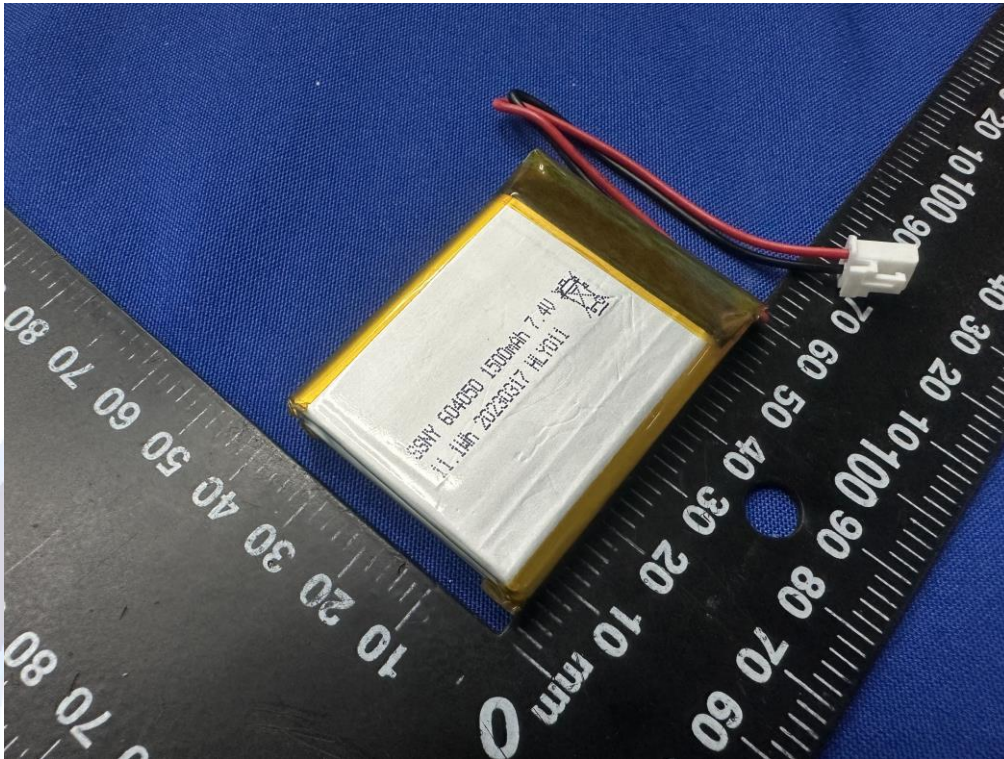

Picture 1. Front view of battery

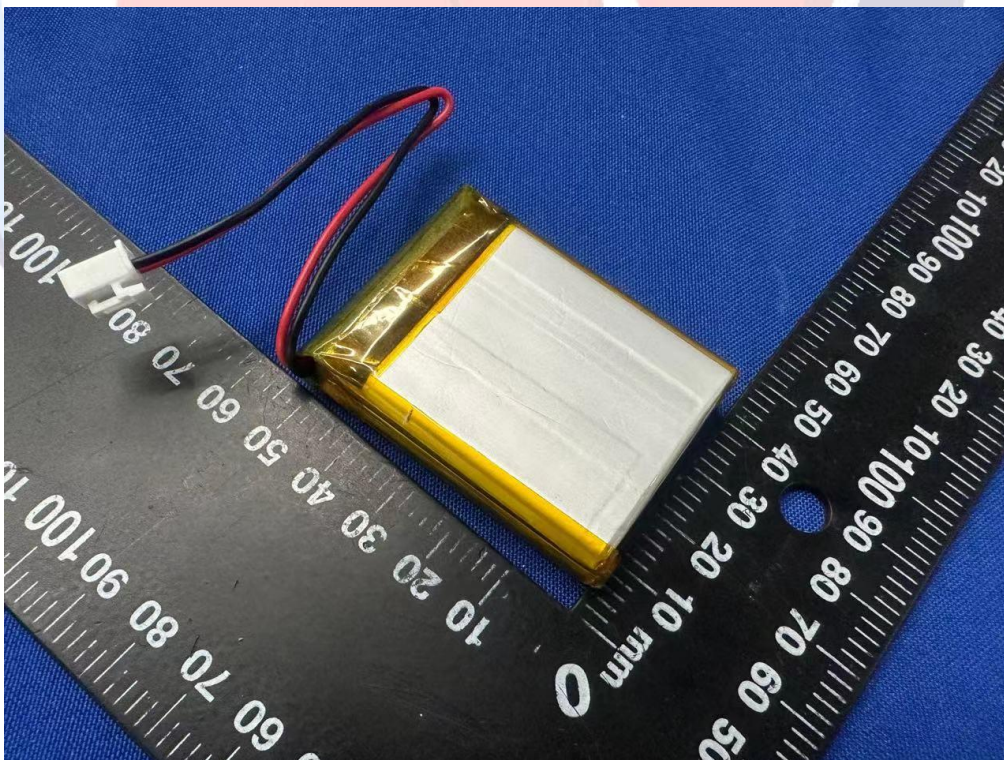

Picture 2. Back view of battery

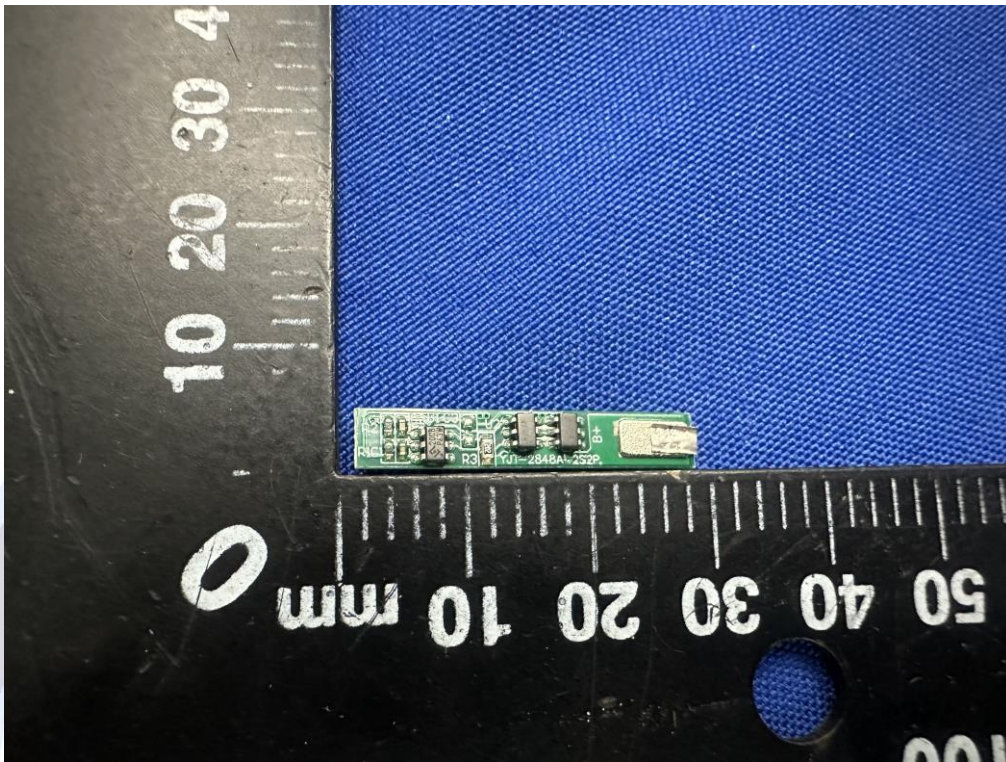

Picture 3. Component view of protection board

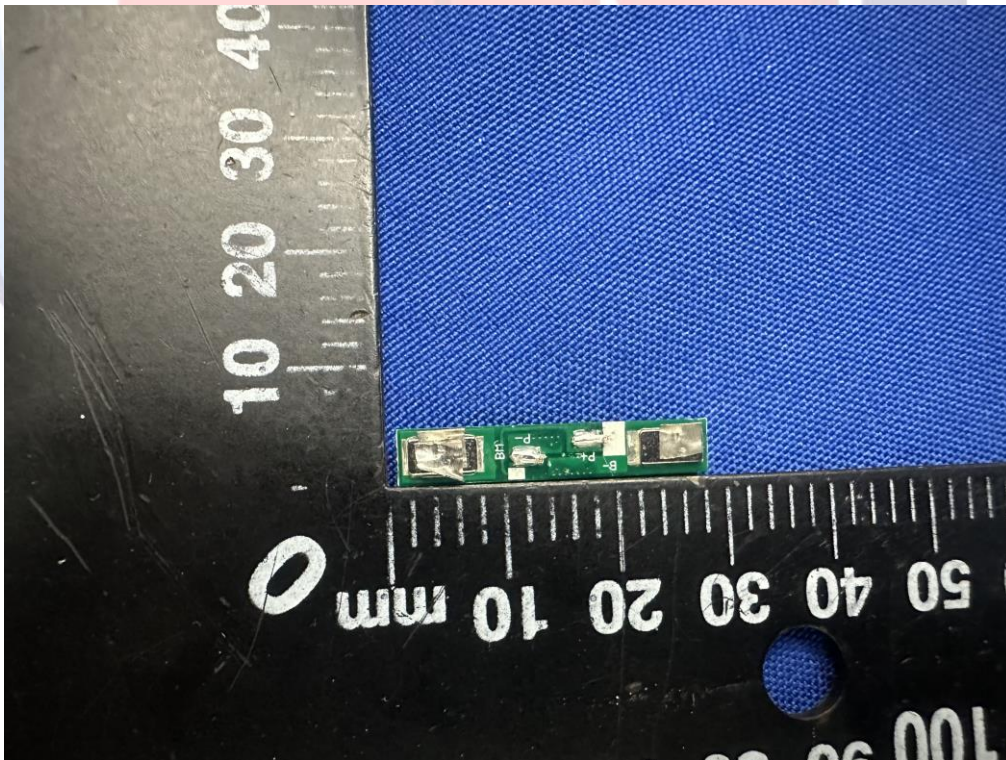

Picture 4. Back view of protection board

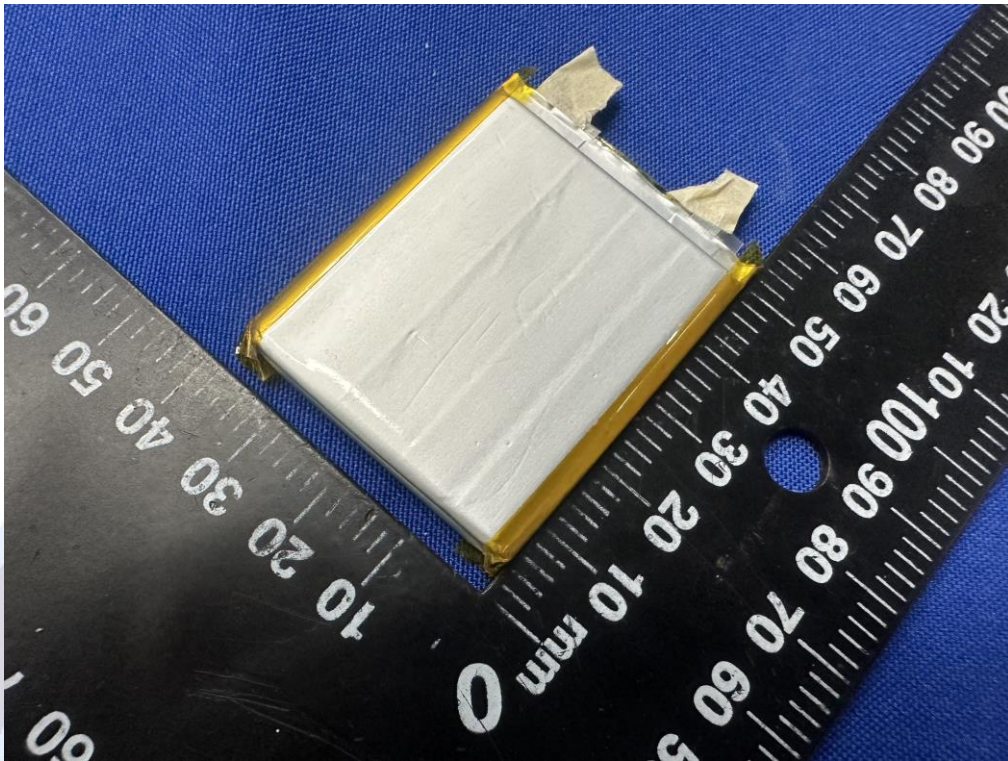

Picture 5. Front view of cell

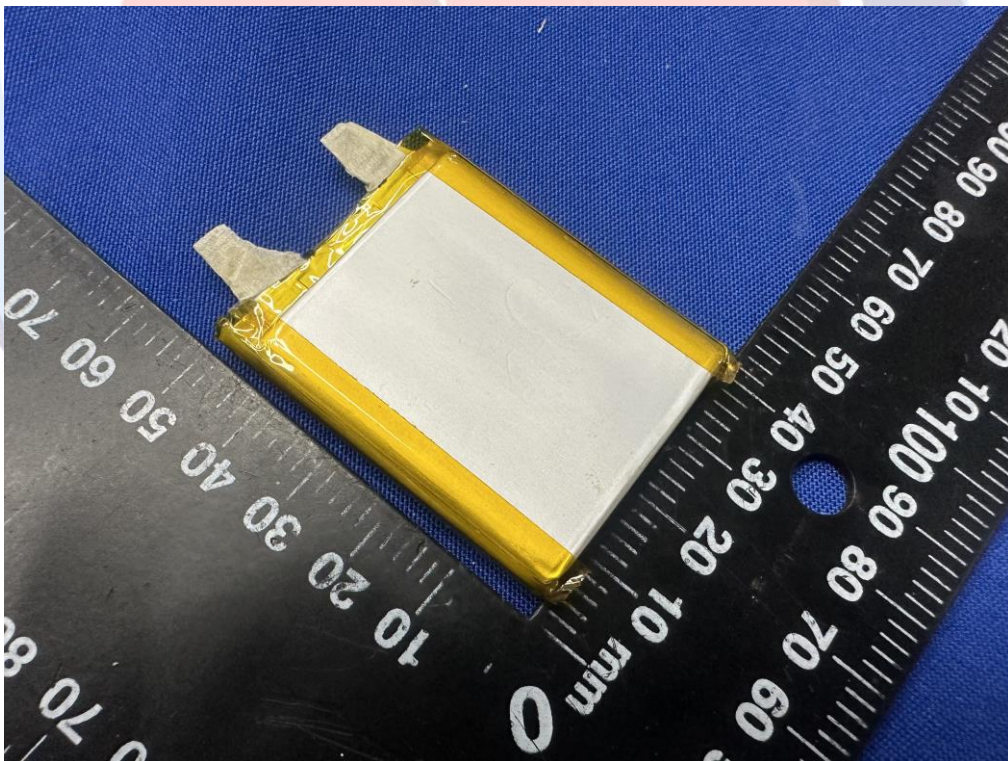

Picture 6. Back view of cell

Important

1. The test report is invalid if it is not affixed the official seal of the laboratory to it.
2. Copies of the test report without the official seal of the laboratory are invalid.
3. It is forbidden to copy the test report partially without the written approval of the laboratory.
4. The test report is invalid without the signatures of Approver, Reviewer and Testing engineer.
5. The test report is invalid if it is blotted out.
6. Objections to the test report must be submitted to CMC within 15 days.
7. The test report is valid for the tested samples only.
8. As for the Verdict, "--" means "no need for judgement", "P" means "pass", "F" means "fail" and "N/A" means "not applicable".

Testing laboratory: CMC Testing International (Shenzhen) Co., Ltd.

Address: 101&104, Building B, Kaihuimao Industrial Park, Liyuan Road, Heping Community, Fuhai Street, Baoan District, Shenzhen, Guangdong, China

Tel: 400-1668-320

E-mail: info@cmczj-lab.com

<http://www.cmczj-lab.com>

-- End of Report --