

CONCORD
CONNECTING TOGETHER

NVR Manual

Contents

CHAPTER 1 PRODUCT OVERVIEW	1
1.1 REAR PANEL	1
CHAPTER 2 NVR INSTALLATION & CONNECTION	2
2.1 HDD INSTALLATION.....	2
2.2 CONNECTION DIAGRAM	3
2.3 POWER SUPPLY CONNECTION	3
CHAPTER 3 COMMON OPERATIONS.....	4
3.1 USING THE SUPPLIED MOUSE.....	4
3.2 USING VIRTUAL KEYBOARD.....	4
3.3 PASSWORD	5
3.3.1 Password Recovery Settings.....	6
3.4 SYSTEM LOGIN	8
CHAPTER 4 NVR STARTING UP	9
4.1 START WIZARD	10
4.1.1 Start Wizard	10
4.1.2 Network Configuration.....	10
4.1.3 Date/Time.....	13
4.1.4 IP Camera	15
4.1.5 Disk.....	16
4.1.6 Resolution.....	17
4.1.7 Mobile.....	17
4.1.8 Summary	18
4.2 LIVE VIEW SCREEN OVERVIEW.....	19
4.2.1 Camera Quick Toolbar	20
4.2.2 Taskbar	27
4.2.3 Alarm Popup	30
4.2.4 Start Menu	31
CHAPTER 5 SYSTEM SETUP	33
5.1 CHANNEL.....	33
5.1.1 IP Channels	33
5.1.2 Live	42
5.1.3 Image Control.....	43
5.1.4 PTZ.....	49
5.1.5 Privacy Zone	60
5.1.6 Motion Detection	60
5.1.7 PIR	62
5.1.8 ROI	63
5.2 RECORD	64
5.2.1 Encoding Settings.....	64

5.2.2 Record	66
5.2.3 Capture Images.....	68
5.3 ALARM SETTINGS.....	69
5.3.1 Motion Alarm	69
5.3.2 PIR Alarm.....	71
5.3.3 I/O Alarm	73
5.3.4 Combined Alarm	75
5.3.5 PTZ Linkage.....	77
5.3.6 Exception Alarm	78
5.3.7 Alarm Schedule	80
5.3.8 Voice Prompts	80
5.3.9 Deterrence.....	84
5.3.10 Siren	88
5.3.11 Alarm Disarm	90
5.4 AI	92
5.4.1 Detection Setup	92
5.4.2 AI Recognition	123
5.4.3 AI Alarm Settings	146
5.4.4 Statistics	157
5.5 NETWORK.....	163
5.5.1 General Settings	163
5.5.2 DDNS	172
5.5.3 Email Settings	173
5.5.4 IP FILTER.....	176
5.5.5 Voice Assistant.....	177
5.5.6 Platform Access.....	191
5.6 STORAGE	195
5.6.1 HDD.....	195
5.6.2 Cloud Storage	200
5.6.3 FTP	204
5.7 SYSTEM CONFIGURATION	207
5.7.1 General.....	207
5.7.2 Multi-user	213
5.7.3 Maintenance	217
5.7.4 IP Camera Maintain	224
5.7.5 System Information	228
CHAPTER 6 AI SCENARIO.....	230
6.1 CROSS COUNTING.....	230
6.1.1 Introduction of Real-time Display & Controls.....	231
6.1.2 Settings of Individual Mode	233
6.1.3 Settings of Grouped Mode	235

6.1.4 Advertise Mode	238
6.1.5 Search Counting Data	240
6.2 FACE ATTENDANCE.....	241
6.3 OBJECT CLASSIFICATION	243
CHAPTER 7 SEARCH, PLAYBACK & BACKUP	244
7.1 SEARCH & PLAY IN GENERAL	244
7.1.1 Video Clip Backup.....	246
7.2 SEARCH, PLAY AND BACK UP EVENT RECORDINGS.....	248
7.2.1 Event Playback Control.....	249
7.3 SUB-PERIODS PLAYBACK.....	251
7.4 SMART SEARCH & PLAYBACK.....	253
7.5 TAG SEARCH & PLAYBACK.....	255
7.6 PLAY EXTERNAL FILE.....	257
7.7 SEARCH & VIEW SNAPSHOTS.....	258
7.7.1 Playing Slideshow	259
7.8 SLICE SEARCH.....	260
7.9 AI SEARCH.....	261
7.9.1 Face Detection	261
7.9.2 Search License Plate	267
7.9.3 Search for Perimeter Intrusion & Line Crossing Events.....	270
7.9.4 Intrusion (Enter Region & Exit Region).....	272
7.9.5 Repeat Visitors.....	274
7.9.6 Face Attendance.....	276
CHAPTER 8 REMOTE ACCESS THROUGH THE WEB CLIENT	278
8.1 BASIC SYSTEM ENVIRONMENT REQUIREMENTS	278
8.2 WEB PLUG-IN DOWNLOADING AND INSTALLATION.....	279
8.3 WEB CLIENT MANAGEMENT.....	281
8.3.1 Login Interface Introduction	281
8.3.2 Main Interface Introduction.....	282
8.3.3 Live Preview Interface	283
8.3.4 Playback Interface.....	291
8.3.5 Remote Setting Interface.....	291
8.3.6 Local Setting Interface	292
CHAPTER 9 BACKUP VIDEO PLAYING	293
CHAPTER 10 APPENDIX.....	296
10.1 FAQ.....	296
10.2 USE AND MAINTENANCE.....	298
10.3 ATTACHED ACCESSORIES (SUBJECT TO THE ACTUAL PRODUCT).....	299

SAFETY INSTRUCTION

Please read the following safety instruction carefully to avoid personal injuries and prevent the equipment and other connection devices from being damaged.

- The device should be used in compliance with local laws, electrical safety regulations, and fire prevention regulations.
- Use the power supply attached or specified by the manufacturer only. Never operate the equipment by using an unspecified power supply.
- Firmly connect the plug to the power socket. Do not connect several devices to one power adapter.
- Power off the device before connecting and disconnecting accessories and peripherals.
- The NVR should not be placed in a dusty field.
- The NVR should be placed in sealing condition with good ventilation and kept away from sunshine, rain and water. If the equipment is accidentally in contact with water, unplug the power cable immediately and contact your local dealer.
- The NVR includes HDD which produces large amount of heat during operation. Do not block the vents (on the top, bottom and both sides) for cooling the system during operation.
- Never place the NVR in an unstable location. The NVR may fall to cause serious personal injury or death.
- Keep the surface of the NVR clean and dry. Use soft cloth to clean the outer case of NVR and do not use liquid aerosol cleaners.
- If smoke, odor or noise rise from the NVR, turn off the power immediately, unplug the power cable, and then contact your local dealer.
- This product contains a coin/button cell battery. If the battery is swallowed, it can cause severe internal burns in just 2 hours and can lead to death.
- If you think batteries might have been swallowed or placed inside any part of the body, seek immediate medical attention.
- Keep new and used batteries away from children.

- Do not dispose of the battery into fire or a hot oven, or mechanically crush or cut the battery, which may cause an explosion.
- Do not leave the battery in an extremely high temperature surrounding environment, which may result in an explosion or the leakage of flammable liquid or gas.
- Do not subject the battery to extremely low air pressure, which may result in an explosion or the leakage of flammable liquid or gas.

Chapter 1 Product Overview

1.1 Rear Panel

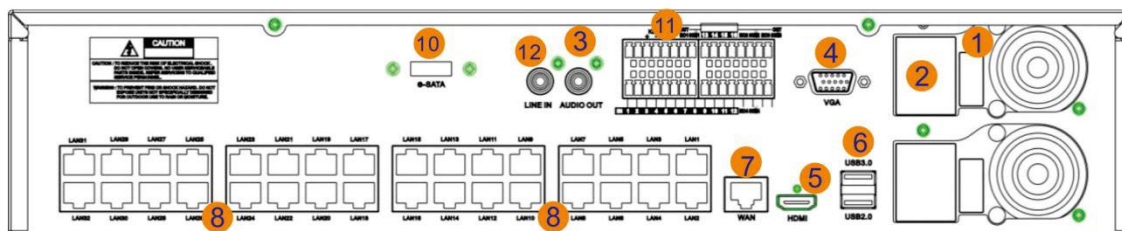
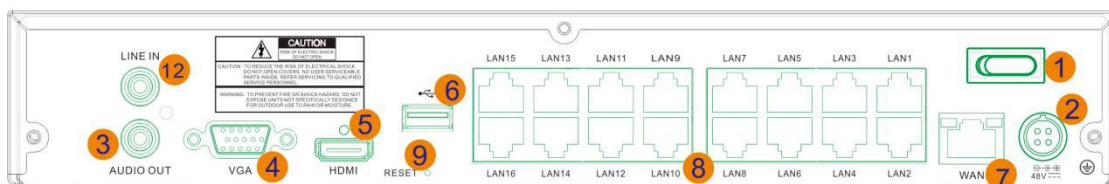
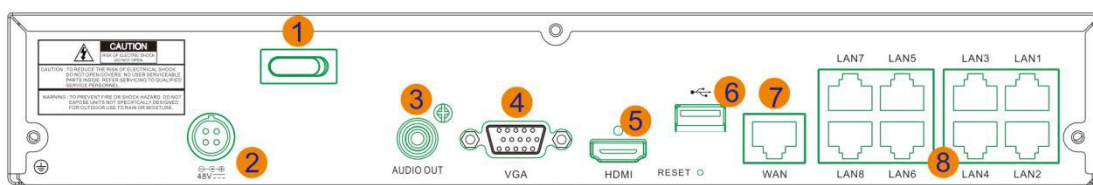
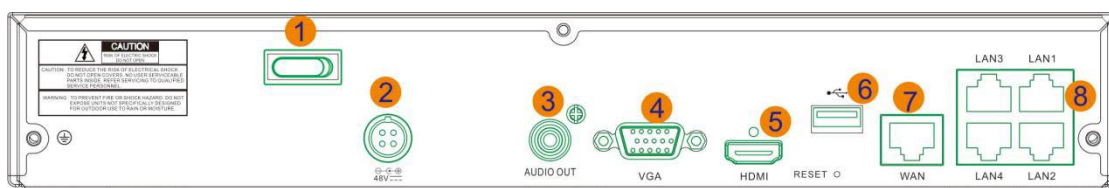

No.	Item	Description
1	Power Switch	Power switch to turn on or turn off the NVR.
2	DC Power Input	Connect the included DC power adapter
3	AUDIO Output	Audio output port. Connect to audio output devices like speakers.
4	VGA Port	Connect a VGA monitor
5	HDMI Port	Connect to HDMI display device(s).
6	USB Port	Connect an external storage device for recording or backup
6	Reset hole	Under the USB port, keep press 10 seconds to load device to default factory settings

7	WAN Port	Connect to a router or network switch
8	LAN Port	Network interface,connect IP cameras. <i>*It is strongly recommended to only one camera per PoE port.</i>
9	RESET Button	Press and hold for 10 seconds with a pin to restore default settings
10	E-SATA	Support E-SATA storage HDD to record and backup.
11	Sensor, Alarm & RS485 Terminals	SENSOR & G: Connect to external sensors; ALARM: Relay output to external alarm devices
12	Line in	Device intercom,micphone connect interface.

Chapter 2 NVR Installation & Connection

2.1 HDD Installation

This NVR supports two 3.5" or 2.5" SATA hard disk drives.

CAUTION: DO NOT install or remove the hard disk drive while the device power is turned ON

HDD Installation:

a) Connect the data and power cables to the two hard disk drives and place the hard disk drives on the NVR case.

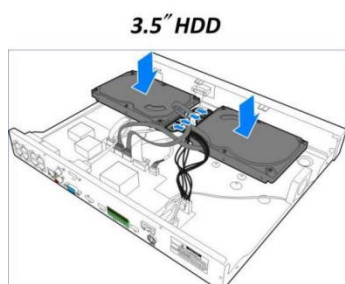
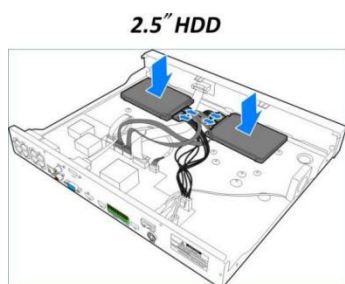

b) Carefully flip the NVR case and secure the hard disk drives to the NVR with the eight (8) screws



Note: Above procedures are for reference only. The practical operation may be different depending on the NVR you purchased.

2.2 Connection Diagram

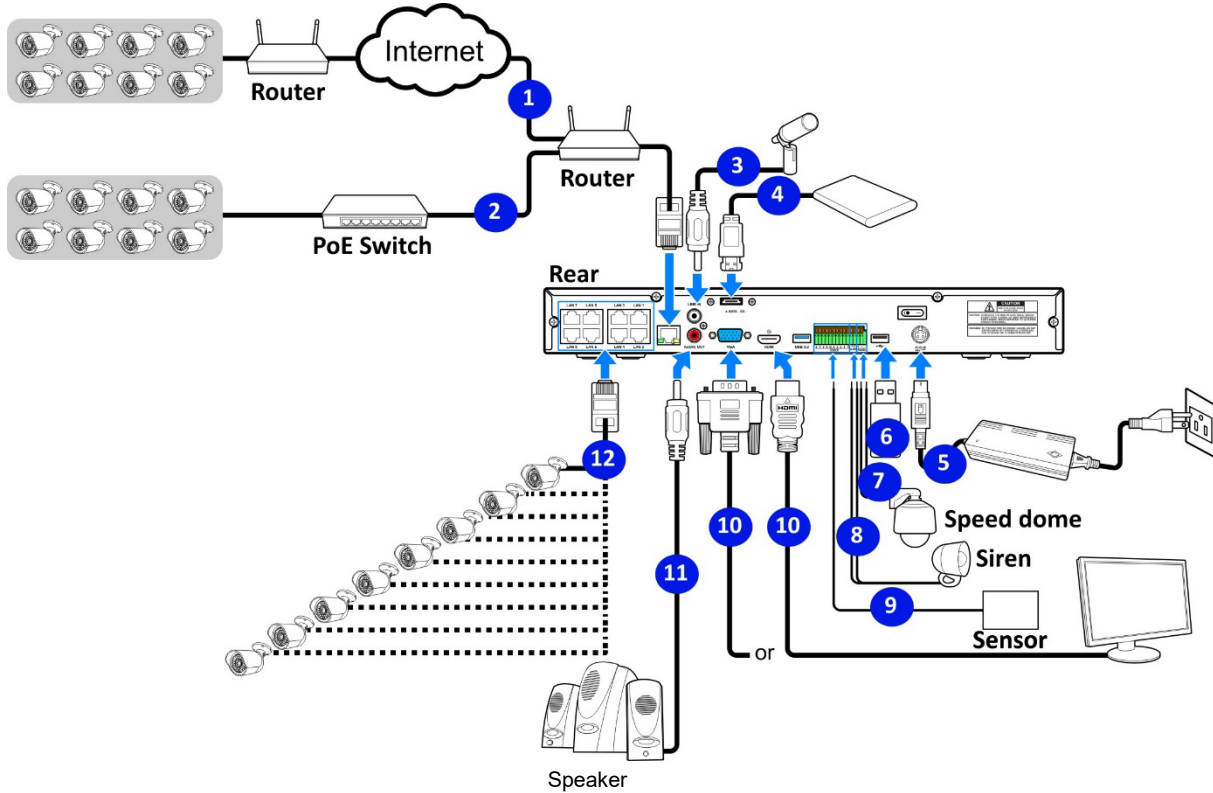

Note: Above diagram is for reference only. The practical connection may be different depending on the NVR you purchased.

2.3 Power Supply Connection

Caution: Use only the supplied power adapter that came with the NVR.

Connect one end of the power adapter to the power connector on the back of the NVR. Plug the other end of the power adapter into the wall outlet.

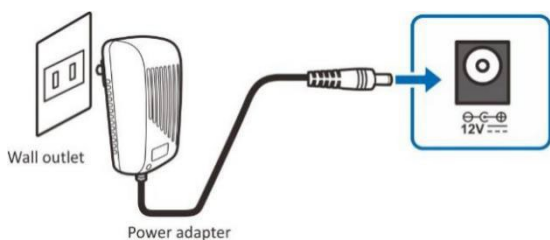

For some specific models, you may need to press the Power switch to turn on the power.

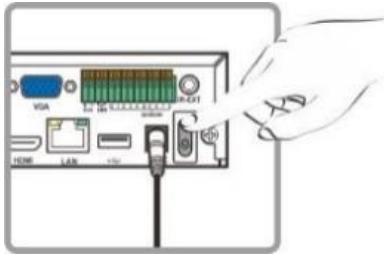

Chapter 3 Common Operations

3.1 Using the Supplied Mouse

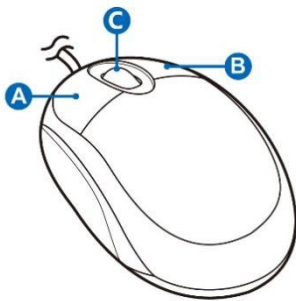

A. Left Button

- Click to select menu options.
- During live viewing in split-screen view, double-click on a channel to view it in full-screen. Double-click the channel again to return to split-screen viewing.
- Click upon a channel on Live Viewing screen to open Camera Quick Toolbar.
- Click and hold to drag sliders and scales on menu mode
-

B. Right Button

Click once to open the Taskbar on the Live Viewing screen.

C. Scroll Wheel

- In menus, scroll to move up / down through the menu content.
- While hovering over the volume control wheel, scroll to turn system volume up / down.

3.2 Using Virtual Keyboard

You will see the virtual keyboard automatically on the screen when you need to enter data, such as enter password, camera title, etc.

Click to toggle the keyboard to upper case and more [punctuations](#)

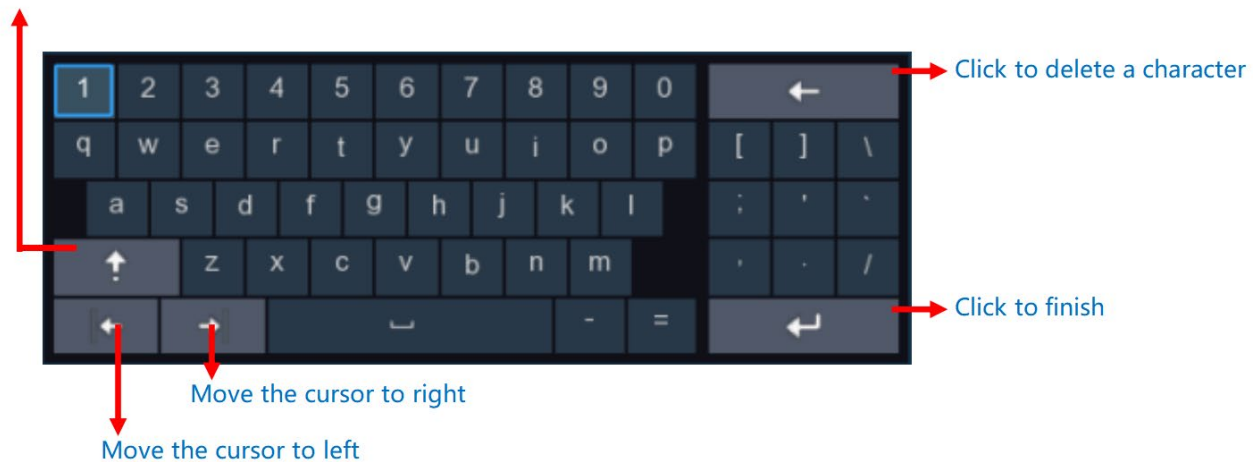

3.3 Password

For the first time when you run the recorder, you must be required to set your own password immediately in order to protect your privacy. Please be sure to record your username and password and save them in a secure place.

Language	<input type="text" value="English"/>	
Device ID	<input type="text" value="000000"/>	(000000)
New Admin Name	<input type="text" value="admin"/>	
Password Strength	<input type="text" value=""/>	
New Admin Password	<input type="password"/>	
Confirm Password	<input type="password"/>	
Unlock Pattern	<input type="text" value="Disable"/>	
Camera Activation Password	<input type="password"/>	<input type="checkbox"/> Same as recorder's password

Language: Choose an available OSD language.

Device ID: Input the device ID in the parentheses. Default ID is 000000. If your device is not using a remote control, you can leave the default value.

New Admin Password: Set the administrator password. The password length should be between 8 and 16 characters and must include at least two combinations of uppercase letters, lowercase letters, numbers, or special characters.

Confirm Password: Re-enter the administrator password.

Unlock Pattern: You can enable Unlock Pattern for quick access to the system. Select "Enable" and then draw the pattern, confirm it twice, and the pattern password will be successfully set

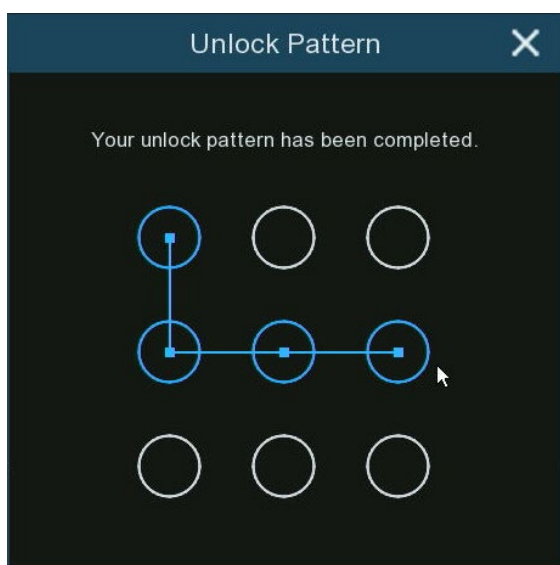

Camera Activation Password: This password is used to activate cameras that are not yet activated and are connected to the NVR. If "Same as recorder's password" is not checked, you can customize the activation password for cameras. If "Same as recorder's password" is checked, the device's login password will automatically be used as the camera activation password.

Click "[Apply](#)" to enter the password reset settings page.

3.3.1 Password Recovery Settings

In case you forget the login password for the recorder, the system provides three methods for password reset. You can choose any one, two, or all three reset methods according to your needs.

Security Questions: This feature enables the modification of the administrator user's password through security questions. After enabling it, you need to select three questions from a list of 15 common questions and set the answers, with a maximum length of 64 characters for each answer.

Password Reset Key: This feature allows the modification of the administrator user's password using a key. After enabling it, you need to click on "Export" to download the key file and certificate.txt to a USB flash drive.

Super Code: This feature enables the modification of the administrator user's password using a super code. If you enable this recovery method, when you forget your password, you'll need to prepare the recorder's MAC address and the current system date, then contact the dealer from whom you purchased the device. They will provide you with a unique Super Code for your device.

3.3.1.1 Forgot Password

When you forget the system login password, you can reset it using the following methods:

1. On the system login page, click the "Forgot Password" button to enter the password reset page.

2. In the "Password Reset Option" dropdown menu, you can select any of the password reset methods that you enabled in section 3.3.1 "Password Recovery Settings" for resetting your password.

- If your recorder has a Reset button on the back, you can also perform a system reset by long-pressing the Reset button to set a new password. Please note that using this method to reset the password will also reset all other system settings to their factory defaults.

3.4 System Login

Once the system password and password reset settings are completed, you can use the newly set password to log in to the recorder.

If you have enabled Unlock Pattern, you can draw the pattern you have set to quickly unlock the device.

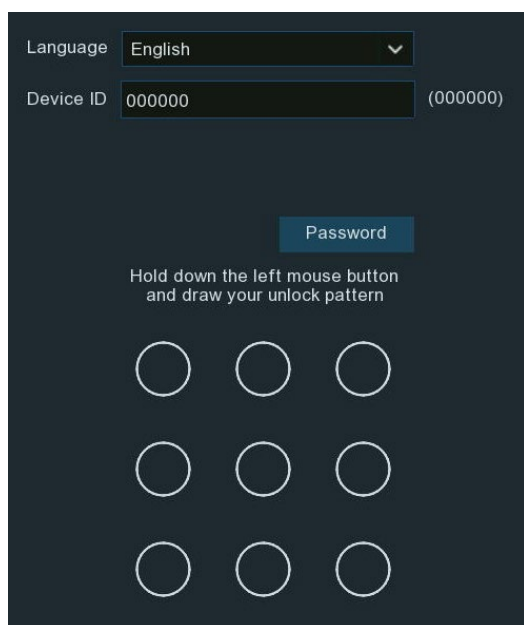

You can also click the "Password" button to switch to the password input interface. After entering the password, click "Login" to access the device.

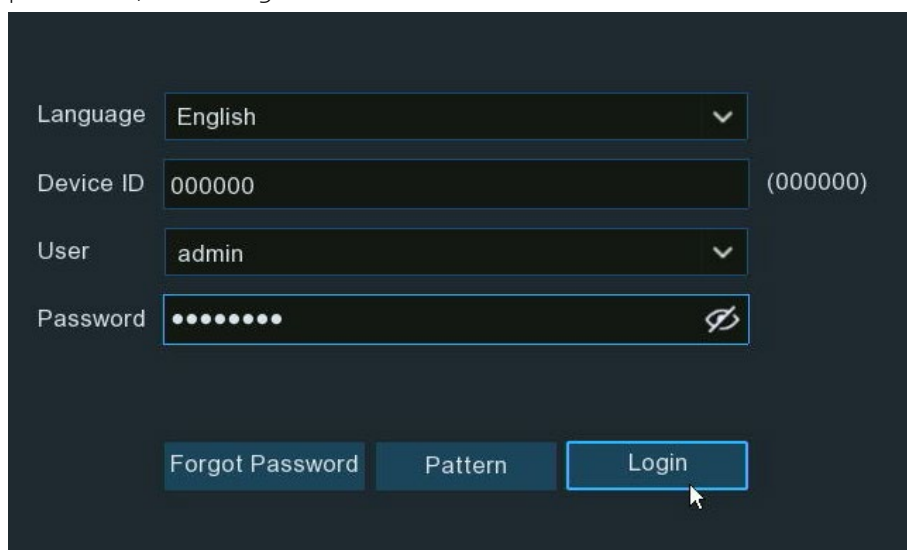

Note: The system interface will be locked for 3 minutes after 5 consecutive logins with incorrect passwords.

Chapter 4 NVR Starting Up

For recorders that support face recognition functionality, upon initial system entry, a “Machine Vision Face Recognition Algorithm Protocol” will pop up. Select "I have read and agree to this agreement" and save it. Afterward, if the device is connected to AI cameras that support face recognition, the face recognition feature can be enabled. Otherwise, the face recognition feature will not be activated.

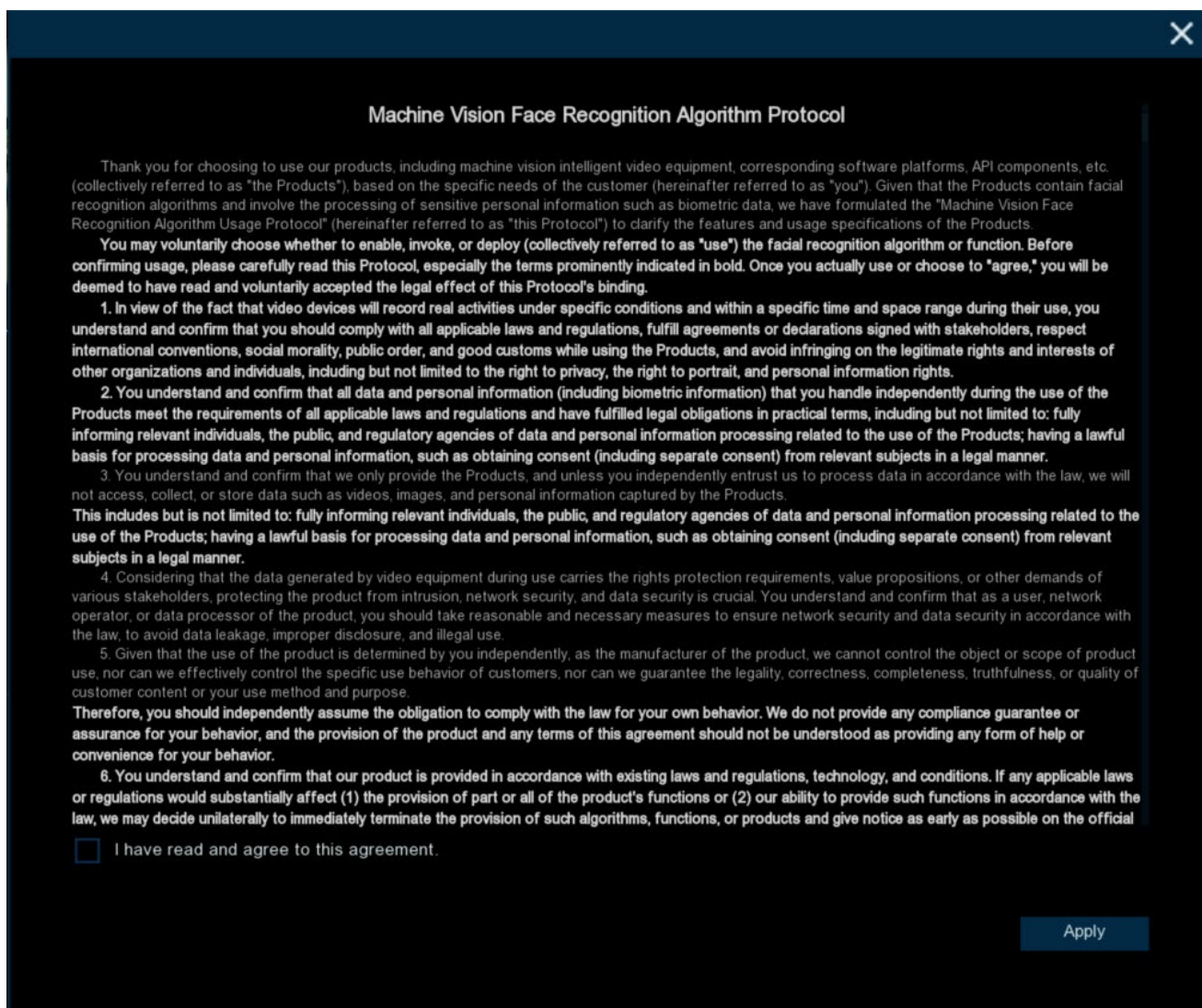

4.1 Start Wizard

When you first use the device, the system will open the Start Wizard menu, allowing you to quickly customize the basic functions of the device.

4.1.1 Start Wizard

Log in the system and click the [Start Wizard](#) to proceed to the next step.

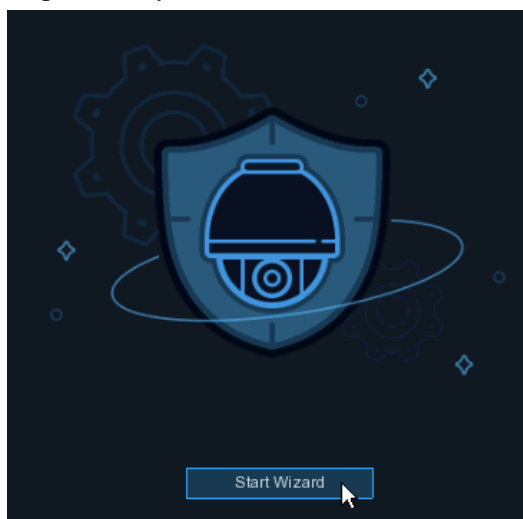

4.1.2 Network Configuration

A screenshot of the "Wizard" window for network configuration. The window title is "Wizard" and it has a close button (X) in the top right corner. The main heading is "Network". There are two dropdown menus: "Network Card Mode" set to "Double Address Mode" and "Network Card Select" set to "LAN1". Below these are tabs for "IPv4" (selected) and "IPv6". Under the "IPv4" tab, there are several input fields: "DHCP IPv4" with a checked checkbox, "IP Address" (172.020.061.021), "Subnet Mask" (255.255.255.000), "Gateway" (172.020.061.001), "DNS1" (172.018.001.222), and "DNS2" (008.008.008.008). At the bottom, there is a "Default Route" dropdown menu set to "LAN1".

Network Card Mode: Switch between Single Address Mode or Double Address Mode. After switching, the recorder will restart. (Note: Models with POE support only Double Network Card Mode).

Single Address Mode: In this mode, both network ports are bound to a single IP address. Selecting this mode can increase bandwidth, form network card redundancy arrays, and share the load. If one network port fails, the other network port immediately takes over all the load, ensuring uninterrupted service.

Double Address Mode: In this mode, each network port is configured with different IP addresses and gateways, working independently. The LAN port connected to the external network should be set as the default route.

Network Card Select: Switch to display the network parameter information for LAN1 or LAN2. This option is grayed out and not available in Single Address Mode.

DHCP IPv4: If connected to a router that allows DHCP, check this box. The router will automatically assign all IPv4 protocol network parameters to the NVR. If unchecked, the IP address, subnet mask, gateway, and DNS will automatically revert to the parameters set during the last unchecked operation. (Note: DHCP IPv6 is not currently supported.)

IP Address: The IP address identifies the NVR in the network. It consists of four groups of numbers between 0 to 255, separated by periods. For example, "192.168.001.100".

Subnet Mask: Subnet mask is a network parameter which defines a range of IP addresses that can be used in a network. If IP address is like a street where you live then subnet mask is like a neighborhood. The subnet address also consists of four groups of numbers, separated by periods. For example, "255.255.000.000".

Gateway: The gateway IP address of the network where the device is located. The default is: 192.168.001.001.

DNS1/DNS2: DNS1 is the primary DNS server and DNS2 is the backup DNS server.

IPv6 Address: Input the IPv6 address you got from your ISP. It consists of eight groups of numbers between 0 and FFFF separated by colons.

For example, "ABCD:EF01:2345:6789:ABCD:EF01:2345:6789"

Subnet Prefix Length: subnet prefix length.

IPv6 Gateway: IPv6 gateway IP address of the network where the device is located.

Default Route: In dual-address mode, set the LAN port connecting to the external network as the default route.

The screenshot shows the 'Wizard' window for network configuration. The 'Network' section is active, displaying a 'Port' configuration table and 'PPPoE' options.

	Service	Protocol	Internal Port	External Port	UPNP Status	Mapping Strategy	UPNP
1	Http/Https/RTSP	TCP	00080	00080	Inactive	Auto	<input type="checkbox"/>
2	Client	TCP	09000	09000	Inactive	Auto	<input type="checkbox"/>

Below the table, the 'PPPoE' section includes:

- Enable PPPOE:
- PPPOE Network Card Select: LAN 1
- User: [text input]
- Password: [text input]

At the bottom right, there are 'Next' and 'Cancel' buttons.

http/https/rtsp: This port is used for remote login to the NVR (e.g., using a web client) or allowing the NVR to transmit real-time streaming media to other devices (e.g., using a media player). ONVIF also uses the same port. If the default port 80 is already occupied by another application in the LAN, please make changes.

Client: This is the port used by the NVR to send information (e.g.: using mobile applications). If the default port 9000 is already occupied by another application, please make changes.

UPNP: Short for Universal Plug and Play, enables NAT traversal rules for automatic port mapping, allowing external computers to access internal network devices, thereby optimizing network efficiency. UPnP functionality requires router support. Before enabling UPnP, please configure the router and set parameters such as internal IP address, subnet mask, and gateway in the network basic configuration to match the router.. If your router does not support UPnP, make sure the port forwarding is completed manually in your router.

Mapping Strategy: Choose "Manual" for mapping type, allowing users to edit external ports (ports on the router). If set to "Auto," it will randomly map an external port (different from the internal port).

PPPoE: PPPoE is a protocol that allows the NVR to connect to the network directly through a DSL modem. Check the Enable PPPoE box, then enter the PPPoE username and password provided by the ISP.

Enable PPPOE: Enable/disable switch for PPPoE. When enabled, the NVR will restart to activate the PPPoE settings.

PPPOE Network Card Select: Select the LAN port corresponding to the dial-up connection. (Note: This option is not displayed in Single Address mode).

User: PPPoE user name.

Password: PPPoE password.

4.1.3 Date/Time

This menu allows you to configure the Date, Time, Date Format, Time Format, Time Zone, NTP and DST.

Date/Time

Click on the calendar icon to set the current system date.



Date and Time	NTP	DST
Date		04/15/2021 
Time		11:28:21
Date Format		MM/DD/YYYY 
Time Format		24Hour 
Time Zone		GMT+08:00 

Date: Click on the calendar icon  to set the system date.

Time: Click  button to edit the system time.

Date Format: Choose from the dropdown menu to set preferred date format.

Time Format: Choose time format between 24Hour and 12Hour.

Time Zone: Choose your time zone.

NTP

NTP stands for Network Time Protocol. This feature allows you to synchronize the date and time automatically on the NVR over Internet. Therefore, the NVR needs to be connected to the Internet.

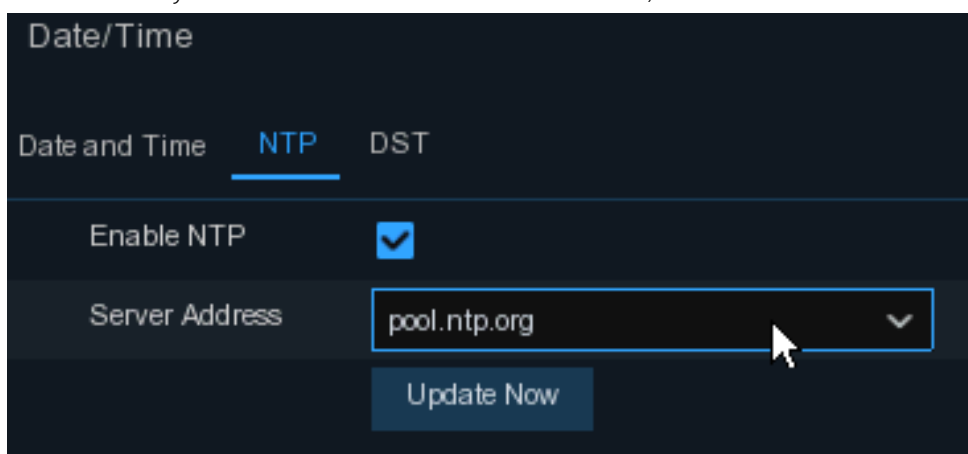

Tick the "NTP" box, and select the NTP server.

Note: The default time zone is GMT, and NTP (Network Time Protocol) is enabled by default with the server address set to pool.ntp.org.

DST

DST stands for Daylight Savings Time.

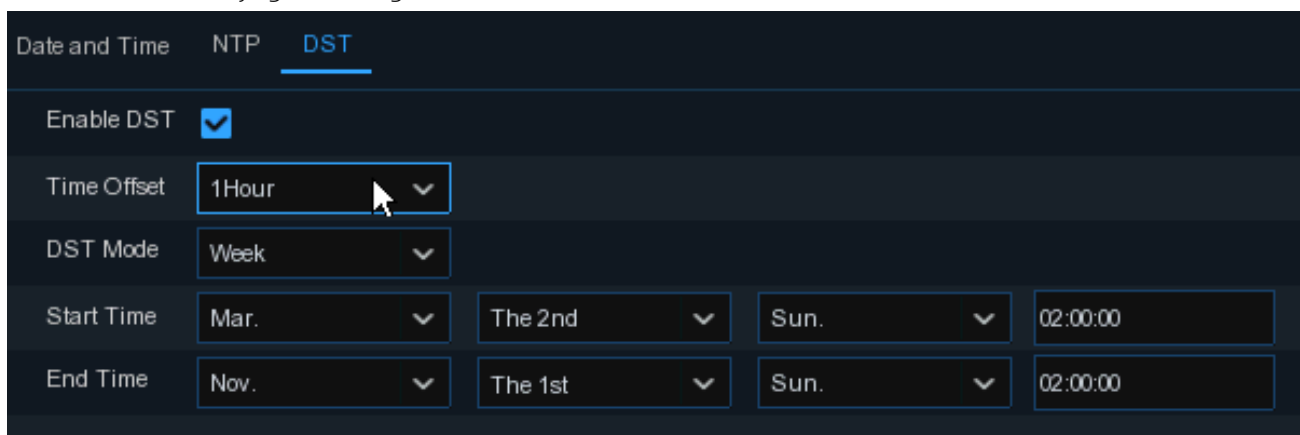

Enable DST: Tick to enable if Daylight Saving Time (DST) is observed in your region.

Time Offset: Select the amount of time to offset for DST.

DST Mode: Choose to set the daylight-saving time in weeks or in days.

Start Time/End Time: Set the start time and end time for daylight saving.

4.1.4 IP Camera

Click **"Search"** to search for IP cameras in the same network. Select multiple IP cameras you want to add and click the icon  Add to NVR. Enter the camera's user name and password to add the camera.

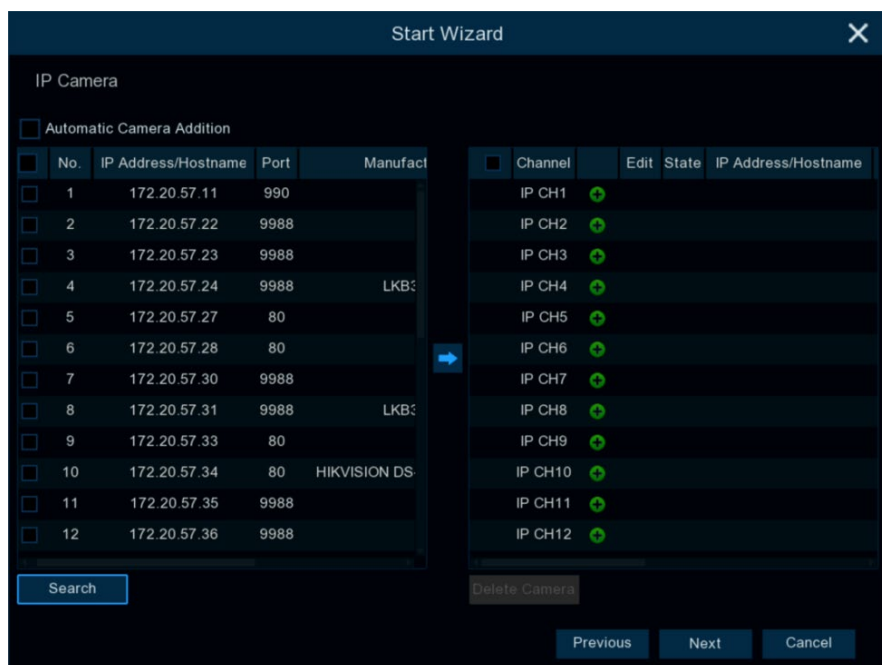

Click Search to **"Search"** for IP cameras and then click any IP camera in the device list.

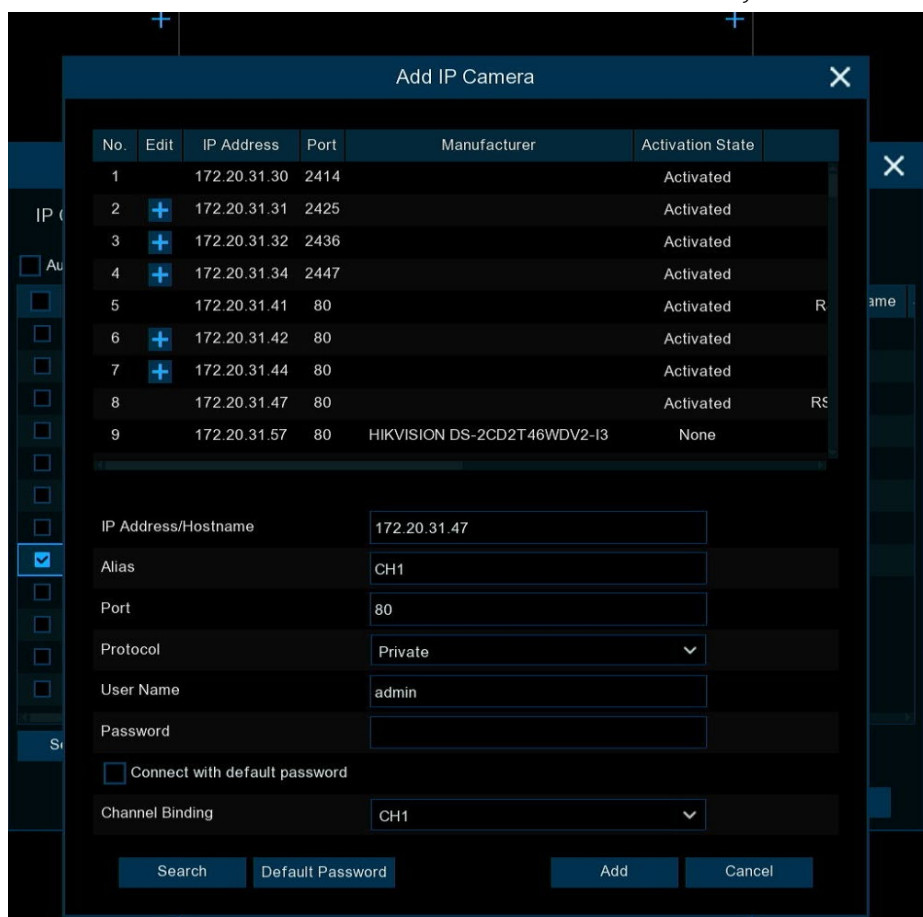

IP Address/Domain: IP address or domain name of the IP camera.

Alias: Name of the IP camera.

Port: The port of the IP camera.

Protocol: Select the protocol to be used for the add-in.

User Name: User name of the IP camera.

Password: Password of the IP camera.

Connect with default password: When checked, the camera connection will use the default password that has been set.

Channel Binding: Select to add the camera to a specified channel.

Camera Mode: Select the mode of the IP camera from the dropdown menu.

4.1.5 Disk

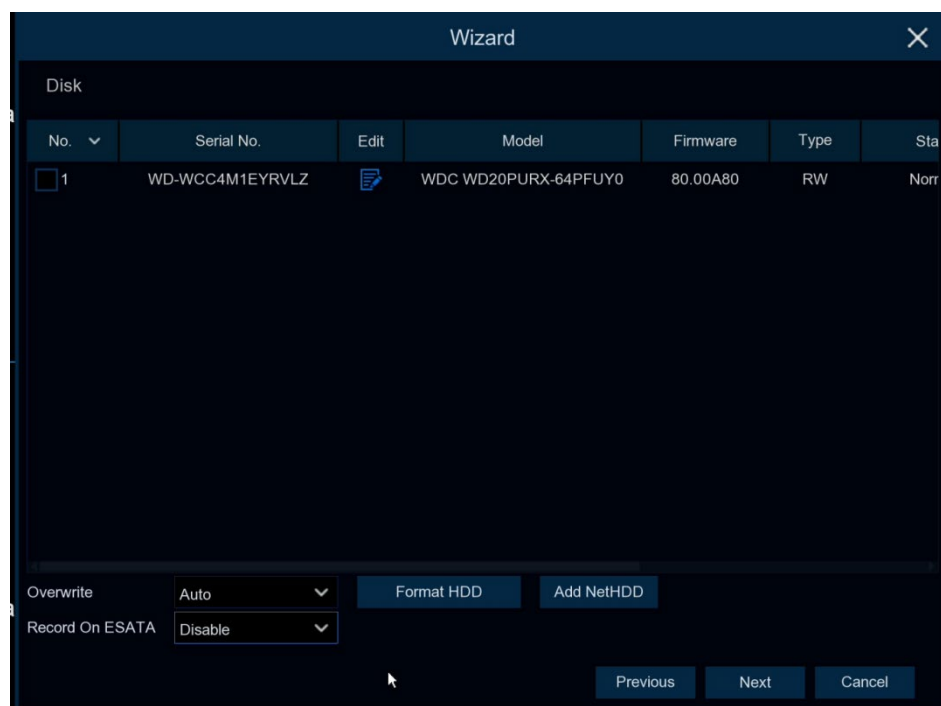

Overwrite: When the hard drive is full, use this option to overwrite old records on the hard drive. For example, if you select the 7-day option, only recordings from the past 7 days will be retained on the hard drive. To avoid overwriting old recordings, choose "Disable." If this feature is disabled, regularly check the hard drive status to ensure it is not full.

To prevent overwriting any old recordings, select **OFF**. If you have set Off on this feature, please check the HDD status regularly to make sure the HDD is not full. Recording will be stopped if HDD is full. We recommended leaving the **Auto** selection as this prevents your NVR from running out of storage space.

Add NAS HDD: To add your NAS disk.

Record On E-SATA: If your NVR comes with an E-SATA port on the rear panel, you can enable to record the video to E-SATA HDD. This function only available when your E-SATA HDD has been connected to the NVR already.

4.1.6 Resolution

Choose an output resolution that matches your monitor. The NVR supports automatically adjusting the output resolution to match the optimal resolution of your monitor during startup. If you connect to a 4K HDMI monitor, you can select a maximum resolution of 4K (3840x2160). If you connect to a VGA monitor, do not select a resolution larger than 1080P (1920x1080).

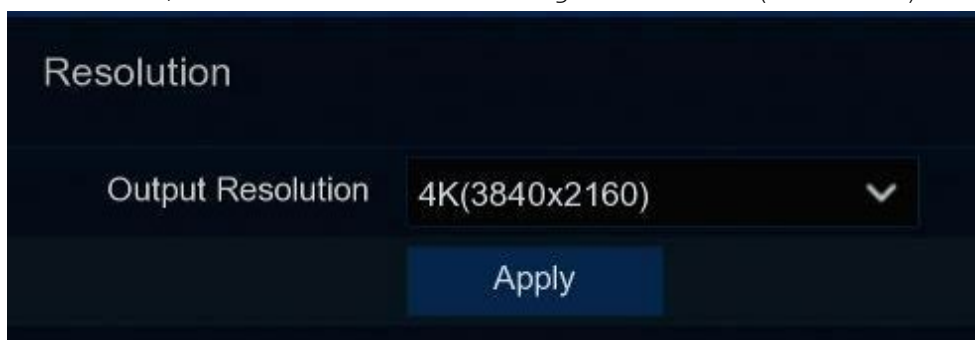

4.1.7 Mobile

If your NVR come with a P2P ID, you can scan the QR code with your mobile app to view the NVR remotely.

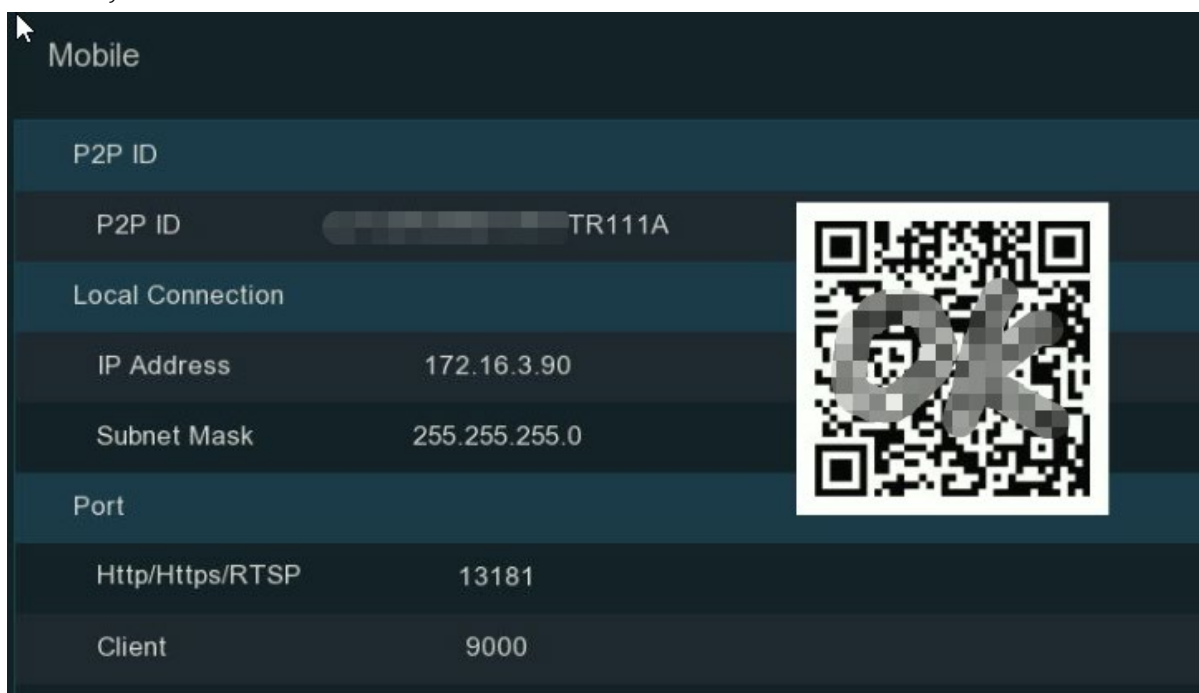

4.1.8 Summary

You can tick the system summary information you had set in the start wizard and finish the wizard. Tick "[Don't show the start Wizard on next startup](#)" if you don't want to display the Start Wizard after the system start. Click [Finish](#) button to save & exit.

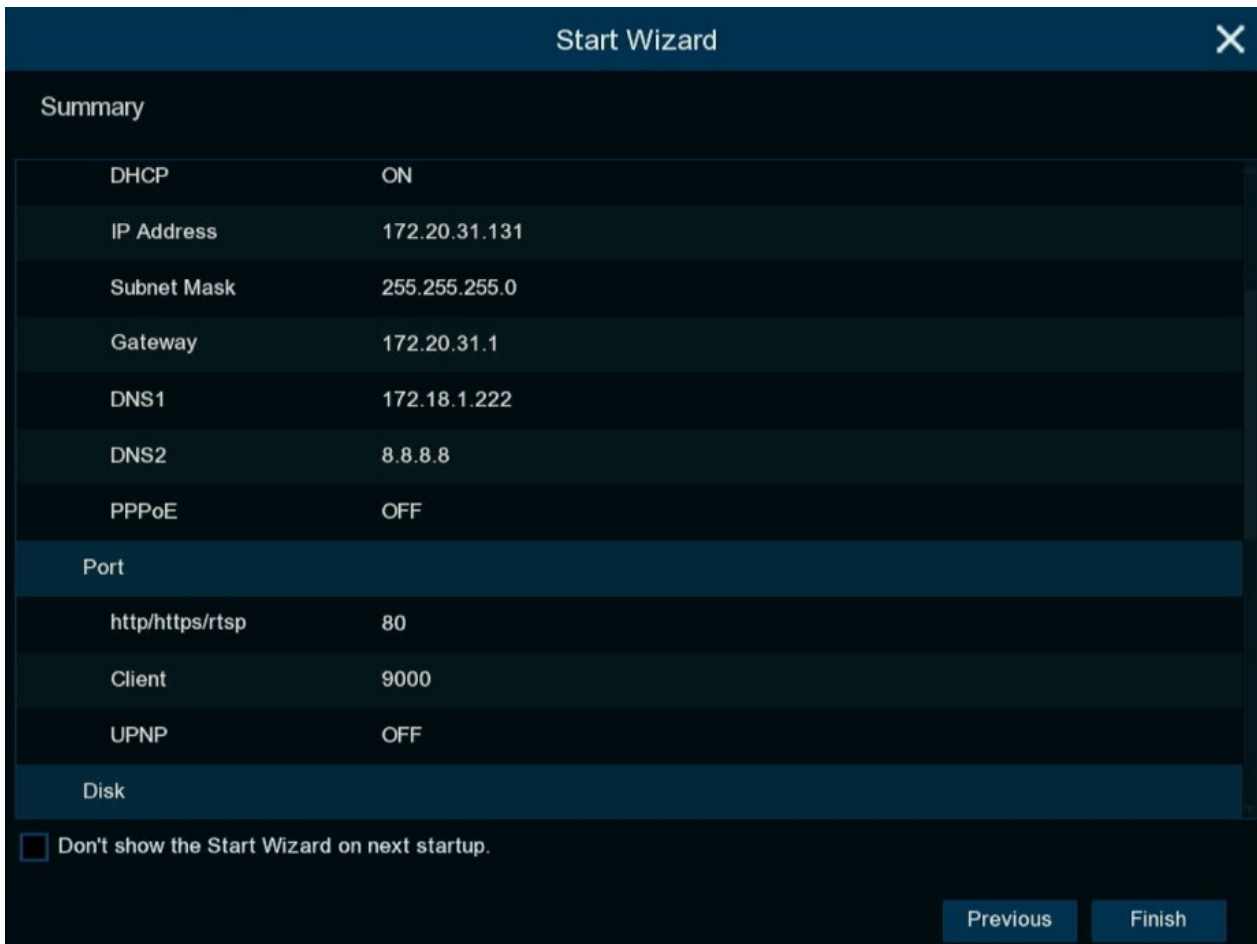

Start Wizard

Summary

DHCP	ON
IP Address	172.20.31.131
Subnet Mask	255.255.255.0
Gateway	172.20.31.1
DNS1	172.18.1.222
DNS2	8.8.8.8
PPPoE	OFF

Port

http/https/rtsp	80
Client	9000
UPNP	OFF





Disk



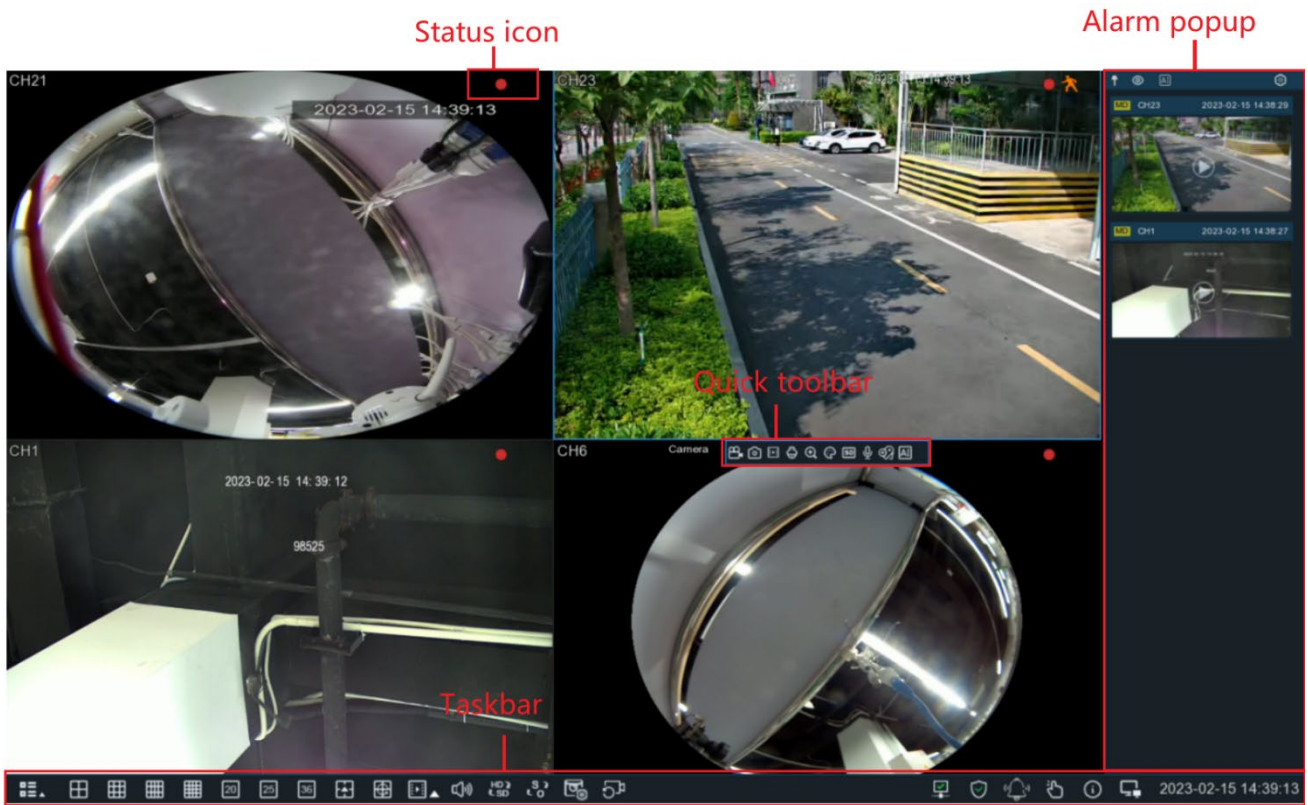

Don't show the Start Wizard on next startup.

Previous Finish

4.2 Live View Screen Overview



Status Icons	
Icon	Description
	The camera is being recorded currently
	A motion alarm is happening
	An intelligent or AI alarm is happening
	The external I/O alarm device is being triggered
	The PIR alarm is being triggered

HDD Error Icons	
Icon	Description
	HDD is uninstalled or in error
	HDD is unformatted
	HDD is full
	HDD is read-only

The other prompt messages that may appear in the screen:

Off-line: The analog camera is disconnected.

No Camera: No camera has been added to the channel.

Decoding Failed: NVR does not support this IP camera compression standard, please change to H.264 compression standard.

Insufficient Resource: The decoding resources for previewing IP channels exceed the decoding specifications limit, or IP channels using MJPEG encoding type can only preview one IP channel, while other IP channels indicate insufficient resources.

Insufficient Bandwidth: Insufficient bandwidth, channel cannot be brought online.

Failed to connect to camera: Failed to establish connection with the IP camera.

Incorrect user name or password: The username or password for the IP camera is incorrect. Please enter the correct username and password.

+ Click to open the Quick Add menu to add an IP camera.







✎ Click to edit the current channel parameters.









4.2.1 Camera Quick Toolbar

In live viewing, click the left button of your mouse on a connected camera to display the Camera Quick Toolbar.

Note: The shortcut buttons that appear may vary depending on the camera model.



Icon	Function	Description
	Manul Record	Click to manually record the channel immediately. If the manually recording is in process, the icon will be in red color. Click one more time to stop manual record.
	Image Capture	Click to save a snapshot of the current camera image. Manual Capture must be enabled to use this feature. For details on enabling Manual Capture.
	Instant Playback	Click to play the latest 5 minutes recording of this channel
	PTZ Control	Click to enter PTZ control panel, click to control zoom and focus of motorized varifocal lens
	Digital Zoom	Click to zoom-in the channel. Scroll the wheel button of your mouse to zoom in and zoom out the image.
	Color Adjustment	Click to adjust the image color of the channel.

	Stream Switch	To switch the live view video stream between HD & SD. HD is mainstream images, SD is substream images.
		If your camera has a built-in speaker, click this button to turn on or turn off the alarm sound.
		If your camera has white light LEDs, click this button to turn on or turn off the LEDs.
		If your camera has warning light LEDs, click this button to turn on or turn off the LEDs.
		Click to start two-way voice communication
		Tag button. It supports to fast search by adding a tag in live view. Tagging enables you to create a searchable, descriptive index of important events or points of interest within extensive video recordings.
		AI statistics. Hover the mouse upon the icon to view AI statistics when the AI function is activated in your NVR.
	Fisheye Mode	When a fisheye camera is connected, this button will appear. Clicking the button will enter fisheye mode preview. (Only certain NVR models support local operation of fisheye mode.)





4.2.1.1 Fisheye Mode

After a fisheye camera is added and comes online, the fisheye operation icon will appear in the preview Quick Tool bar and playback operation menu. Click the button  will take you to the fisheye mode operation page.

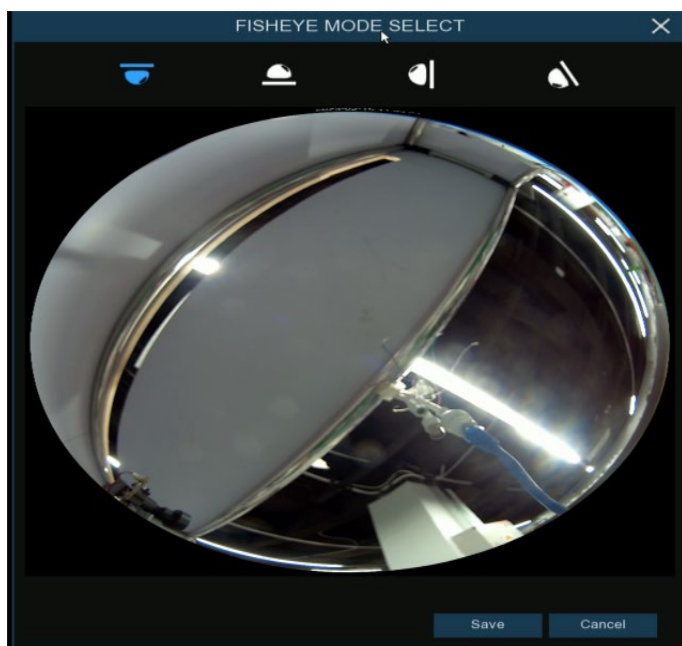

On the fisheye-mode operation page, click the setting button  on the toolbar at the bottom to open the menu for setting the fisheye camera installation mode. Then, select the mode in accordance with the actual installation mode, and save the setting to make it take effect.



Icon	Description
	Ceiling Installation
	Desktop Installation
	Wall Mount Installation
	Tilted Installation

After the corresponding fisheye installation mode is set, the viewing modes supported in the selected installation mode are displayed on the toolbar at the bottom. You can switch the modes as needed and you can also drag and zoom the screen.



 **VR Mode:** In VR mode, the picture will be displayed in fisheye format. You can click and hold the left mouse button in the picture, then drag the mouse to rotate the picture. You can also use the mouse wheel to zoom in and out of the picture.



 **3D Cylinder Mode:** In this mode, the picture will switch to a 3D cylindrical shape. You can click and hold the left mouse button in the picture and then drag the mouse to rotate the picture.

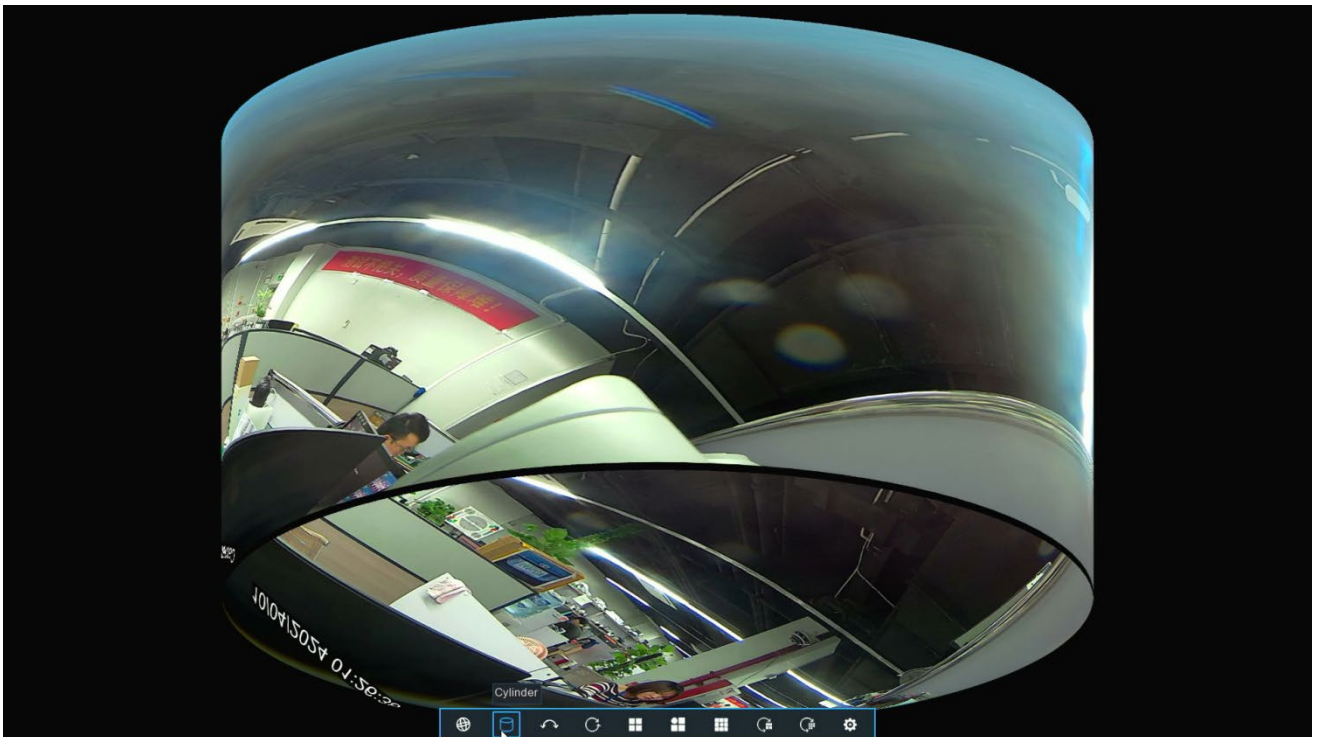

 **180° Panorama Mode:** In this mode, the picture will display two 180° panoramic views. You can click and hold the left mouse button in the picture and then drag the mouse to scroll the picture.

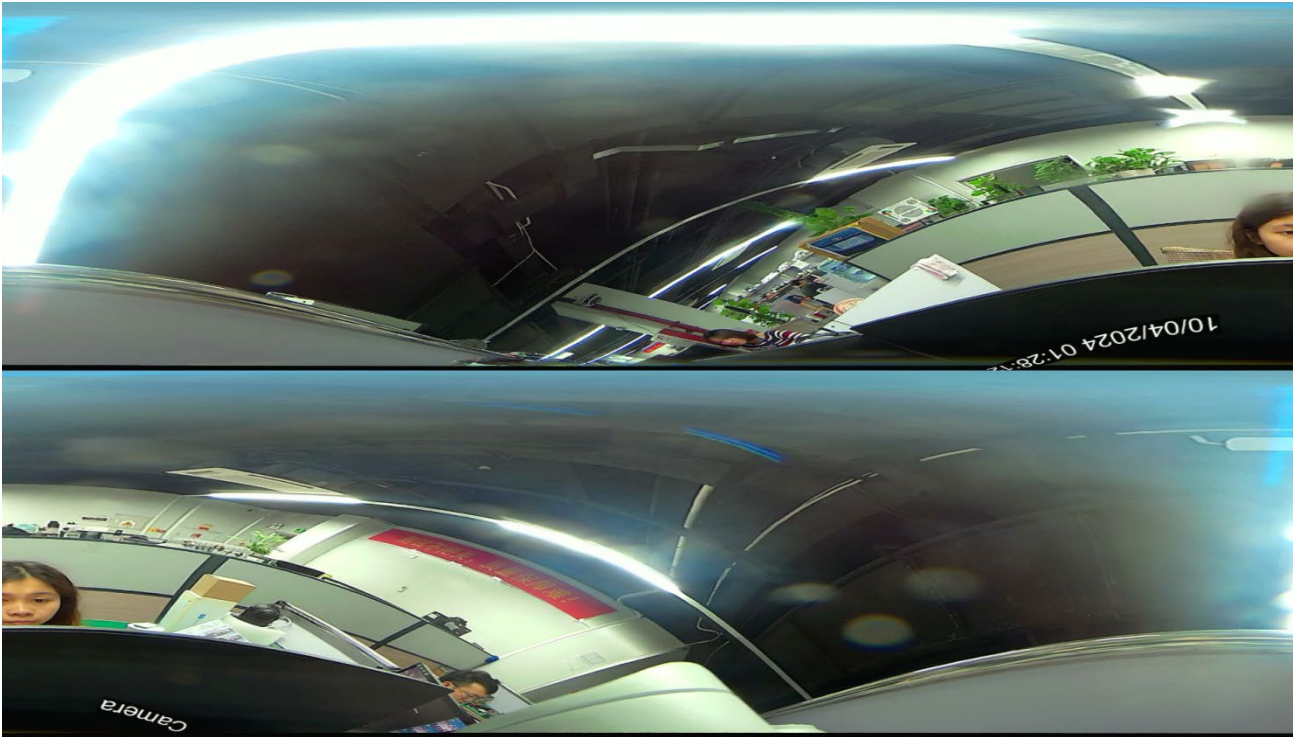

 **360° Panorama Mode:** In this mode, the picture will be displayed as a 360° flat panoramic view. You can click and hold the left mouse button in the picture, then drag the mouse to scroll the picture.



 **4-Split Mode:** The image will be divided into four panels. You can click and hold the left mouse button in any panel, then drag the mouse to rotate the image. You can also use the mouse scroll wheel to zoom in and out of the image.



 **Fisheye + 3-Split Mode:** The screen will be divided into four sections, with the fisheye view displayed in the top right corner and the remaining three sections displaying split views. You can click and hold the left mouse button in any split view, then drag the mouse to rotate the image. You can also use the mouse scroll wheel to zoom in and out of the image. Additionally, you can directly click and hold the left mouse button in the fisheye view and drag any colored frame to move the image.



 **Fisheye + 8-Split Mode:** The screen will be divided into nine sections, with the fisheye view displayed in the center and the remaining eight sections displaying split views. You can click and hold the left mouse button in any split view, then drag the mouse to rotate the image. You can also use the mouse scroll wheel to zoom in and out of the image. Additionally, you can directly click and hold the left mouse button in the fisheye view and drag any colored frame to move the image.

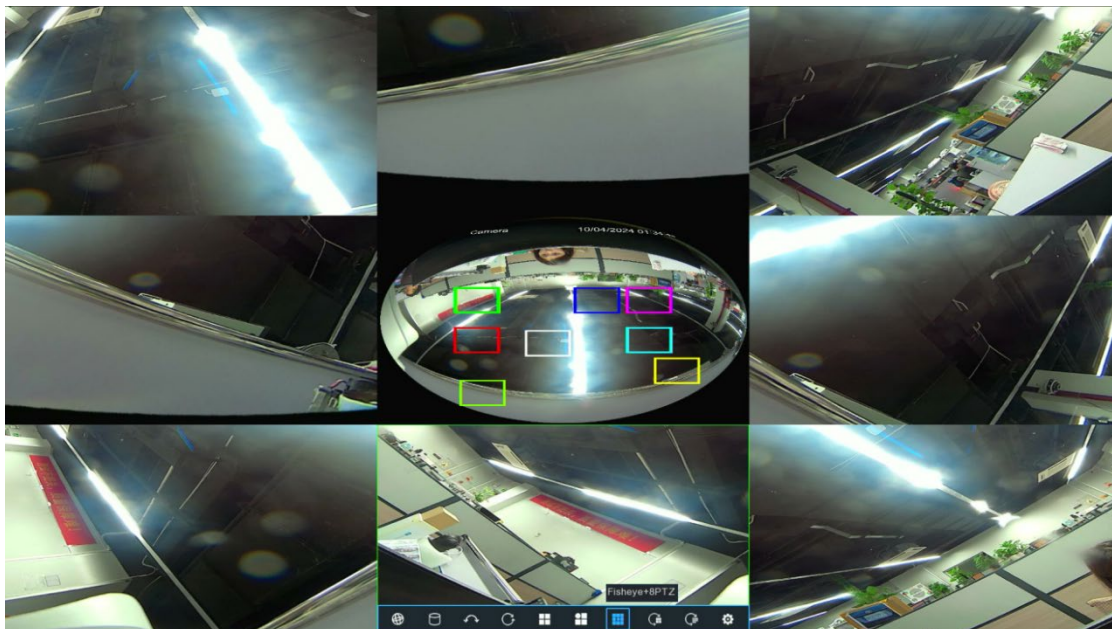

 **Panorama + 3-Split Mode:** The screen will be divided into four sections, with a 360° panoramic view displayed in the top right corner and the remaining three sections displaying split views. You can click and hold the left mouse button in any split view, then drag the mouse to rotate the image. You can also use the mouse scroll wheel to zoom in and out of the image. Additionally, you can directly click and hold the left mouse button in the panoramic view and drag any colored frame to move the image.

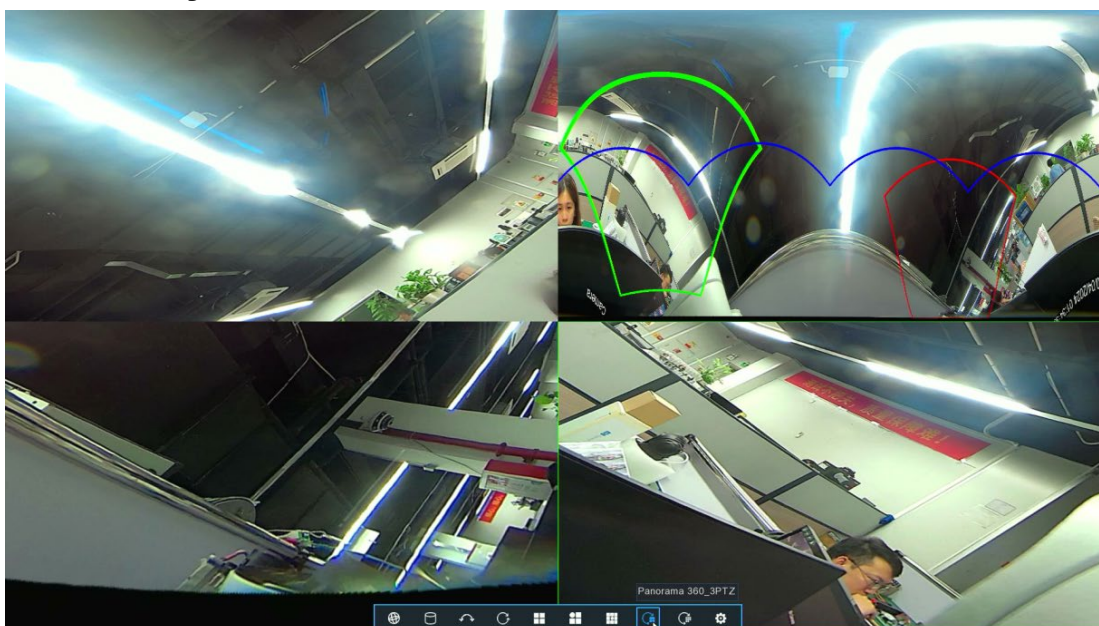











 **Panorama + 8-Split Mode:** The screen will be divided into nine sections, with a 360° panoramic view displayed in the center and the remaining eight sections displaying split views. You can click and hold the left mouse button in any split view, then drag the mouse to rotate the image. You can also use the mouse scroll wheel to zoom in and out of the image. Additionally, you can directly click and hold the left mouse button in the panoramic view and drag any colored frame to move the image.



4.2.2 Taskbar

On the preview page, right-click the mouse, or move the mouse to the bottom of the screen to display the Task Bar. In the Task Bar, you can adjust the preview display of the device or access the system menu.



Icon	Function	Description
	Start Menu	Click to pop up the Start Menu
	Display Layout	Click to select different display layouts for preview channels
	More Layouts	Click to select more layouts for preview display
		Click to start viewing channels in a sequence.
	Quick Playback	Playback all channels from the beginning of the day, you can also click on the triangle at the bottom right to choose to playback from the last 5s, 10s, 30s, 1Min, 5Min.
	Audio Volume	Click to adjust audio output volume
	Stream Switch	Click to switch the live view image resolution for all channels between mainstream and substream
	Scale Switch	Click to switch the image scale for all channels between original and stretch.
	View Quality	Click to switch among real-time, balanced, or smooth view. It affects the live view video quality by changing the bitrate and frame rate.
	Restore Channel Positions	Click this button to restore the scrambled channel positions.

On the right side of the Task Bar, the status information of the devices is shown.



Icon	Function	Description
	Network Status	Network is disconnected
	Network Status	Network is connected but offline
	Network Status	Network is well connected
	Armed Status	NVR is in Armed Mode
	Armed Status	NVR is in Disarmed Mode
	Fan Status	Fan is in normal operation
	Fan Status	Fan is in abnormal state
	Audible and Visual Alarm	Turn on or off lights and alarm bells for all supported channels
	Manual Operation	Manual recording and manual alarm configuration
	System Info	View system information, channel information, recording information, and network status
	USB Wi-Fi	For USB external Wi-Fi devices, click to remove before safely unplugging the device to avoid potential system abnormalities
	Dual Screen Switching	Click the button to switch the mouse between the main screen and the auxiliary screen. If you accidentally click this button and only have one monitor connected, mouse control will return after a few seconds.

4.2.3 Alarm Popup

The Alarm Notification Panel is located on the right side of the screen and is used to display thumbnails of triggered alarm events. These events are color-coded based on their type. To scroll through the notifications, use the mouse scroll wheel (make sure the mouse pointer is over the notification panel). Click the play button next to or above the thumbnail to view the event.

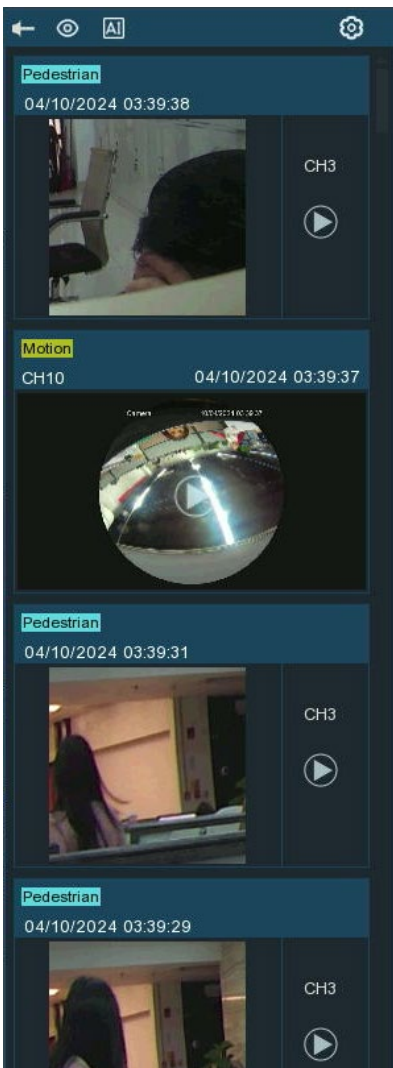

When this icon ← is displayed, the notification panel will automatically hide when there are no alarm events and automatically appear when there are alarm events. After clicking this icon, it will change to ↑. At this point, the notification panel will remain fixed and always displayed

You can click the icon 🗙 to hide the alarm thumbnail display, or click 🗖 to show the thumbnails.

Clicking on the icon AI allows you to view statistical data for AI alarm events.

Clicking on the icon ⚙️ allows you to select the types of alarm messages you want to receive.

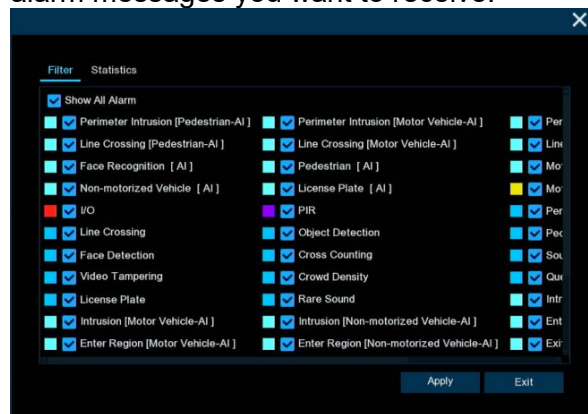

You can also customize the time duration and channels to display in the AI statistical information.

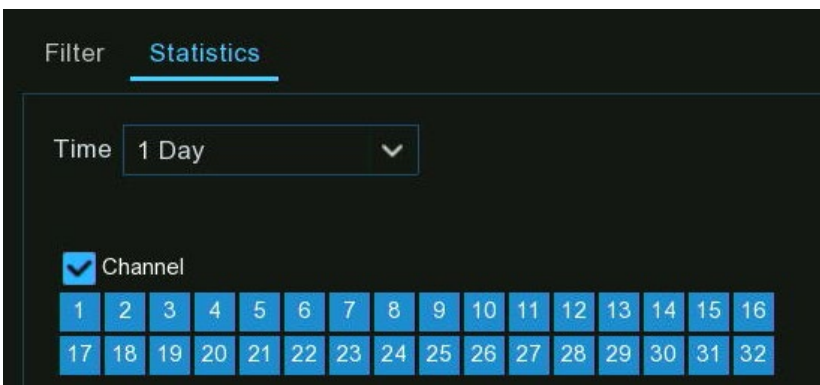

4.2.4 Start Menu

With the Start menu, you can switch user, search & playback, enter system setup menu, lock & unlock the screen, shut down, reboot & logout the system.

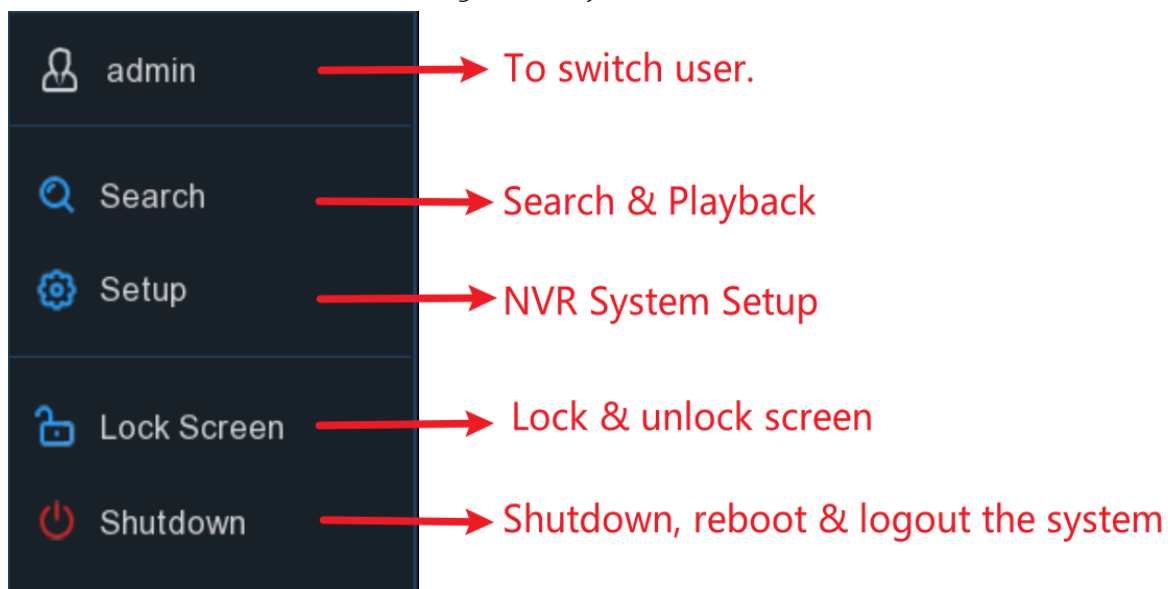

4.2.4.1 Lock and Unlock Screen

When the NVR is left idle for an extended period without menu operations, the screen will be locked to protect system security. You can also manually lock the system by clicking the lock screen icon  while in the unlocked state

If the system is locked, you can click icon  to unlock the system for further operation.

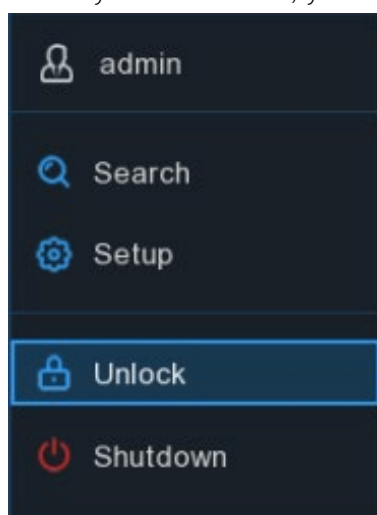

4.2.4.2 Shutdown

Click the **Shutdown** button from Star Menu, you're able to shut down, reboot or logout the NVR. Click **OK** button, system will require to input the user password to authenticate.

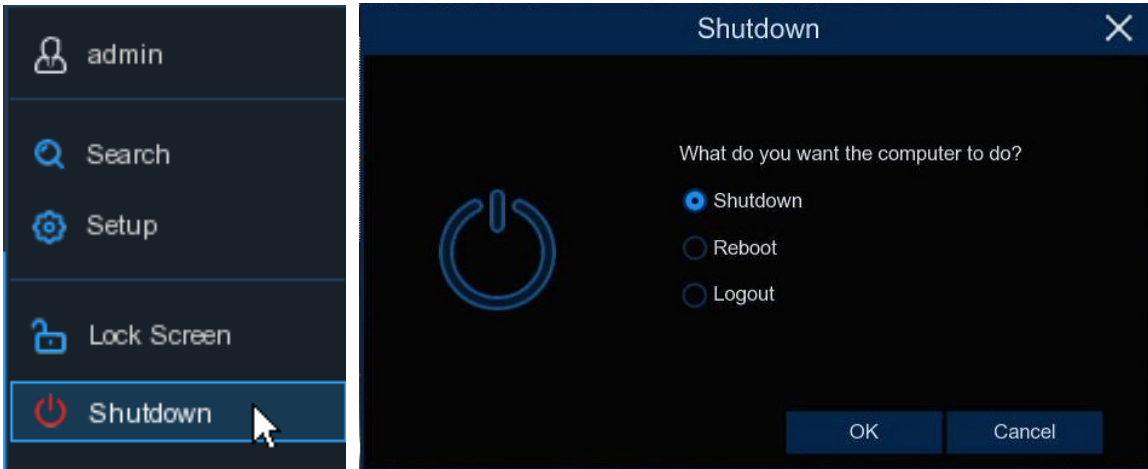

By selecting Logout, you will no longer be able to view the screen in real time and will need to log in to the system before you can proceed further.

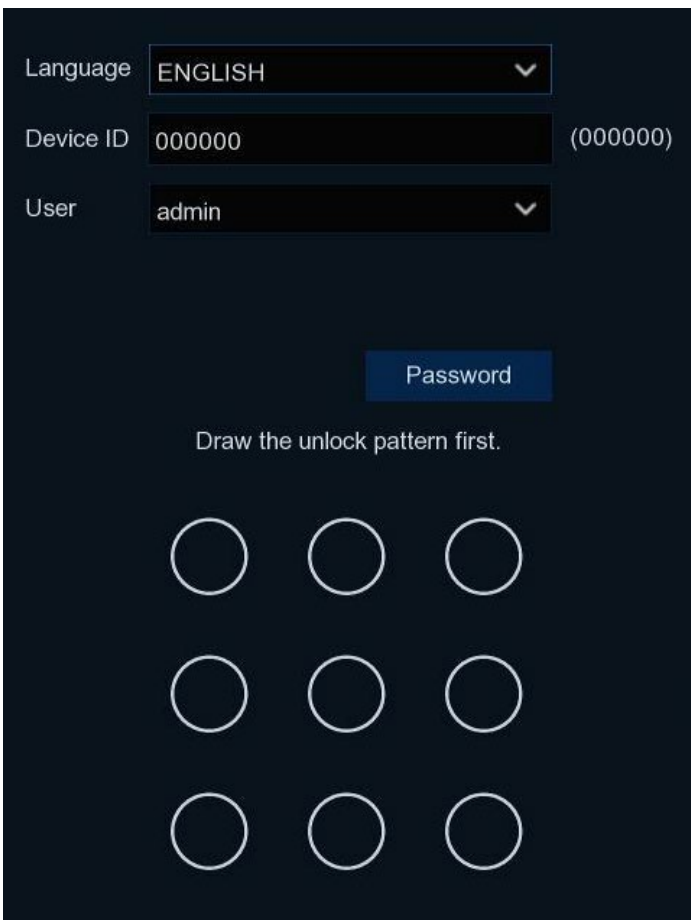

Chapter 5 System Setup

You are able to configure the NVR for Channel, Record, Alarm, Network, Device, System, AI, AI Scenario from Start Menu.

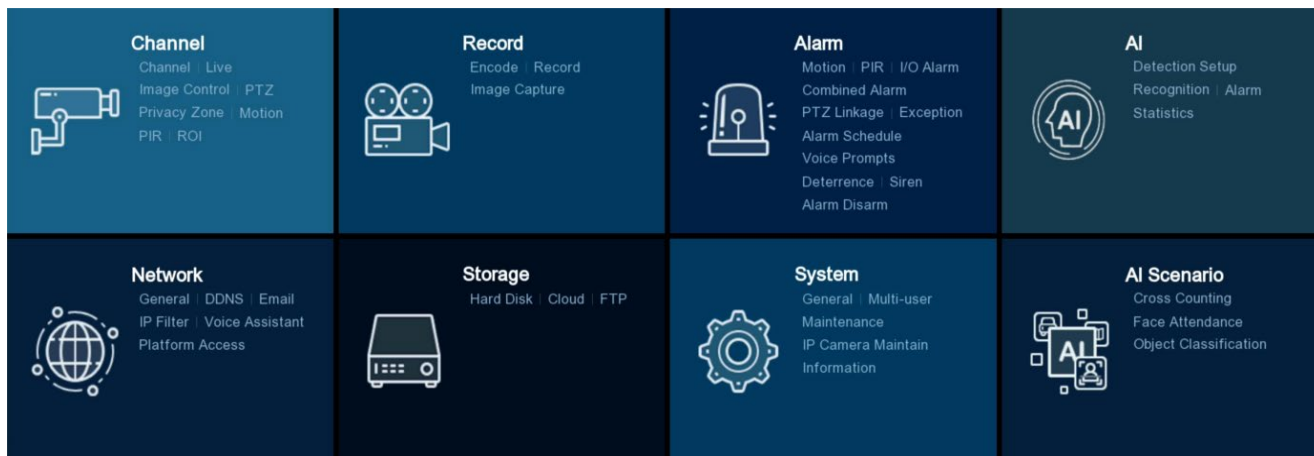

5.1 Channel

In this section, you are able to manage the camera connection, live view display, camera's image, PTZ setup, video cover, motion setup, and more.

5.1.1 IP Channels

In this menu, you can manage IP cameras by adding or deleting channels, and also manage the connection passwords for IP Cameras. If it's a PoE-enabled NVR, you can also view real-time PoE power supply status.

Channel	Mode	Operation	State	IP Address	Port	Manufacturer	Device Type	Protocol	MAC Address	Software Version
CH1	Auto			172.20.57.52-2	80		IP CAMERA	Private	00-23-63-9E-81-AD	V45.85.8.2.3_231213
CH2	Auto			172.20.57.28	80		IP CAMERA	Private	00-23-63-9F-A0-BB	V40.45.8.2.4_231102
CH3	Auto			172.20.57.34	80	HIKVISION	DS-2CD3T25-I3	Onvif	10-12-FB-40-EB-B6	V5.5.800 build 210628
CH4	Auto			172.20.51.37	80		INP-72A0018MIA	Private	00-23-63-9A-39-96	V40.45.8.2.4_231102
CH5	Auto			172.20.57.33	80		IP CAMERA	Private	00-23-63-9E-7F-C6	V25.11.8.2.4_231208
CH6	Auto			172.20.57.32	80		IP CAMERA	Private	00-23-63-8B-A4-E1	V31.35.8.2.4_231109
CH7	Auto			172.20.57.40	80		IP CAMERA	Private	00-23-63-A2-26-97	V34.45.8.2.3.4_230522
CH8	Auto			172.20.57.53	80		IP CAMERA	Private	00-23-63-AC-B7-9B	V31.35.8.2.4_231229

At the bottom of the interface, there is an 'Add Device' button and a checkbox for 'Automatic Camera Addition'. The status bar at the bottom right shows 'Total Bandwidth:128Mbps, Used Bandwidth:36.5Mbps'.

5.1.1.1 Adding IP Camera

If your NVR has PoE ports and you've connected plug-and-play IP Cameras to these ports, then they should automatically appear in the list of added devices under the IP Channel section.

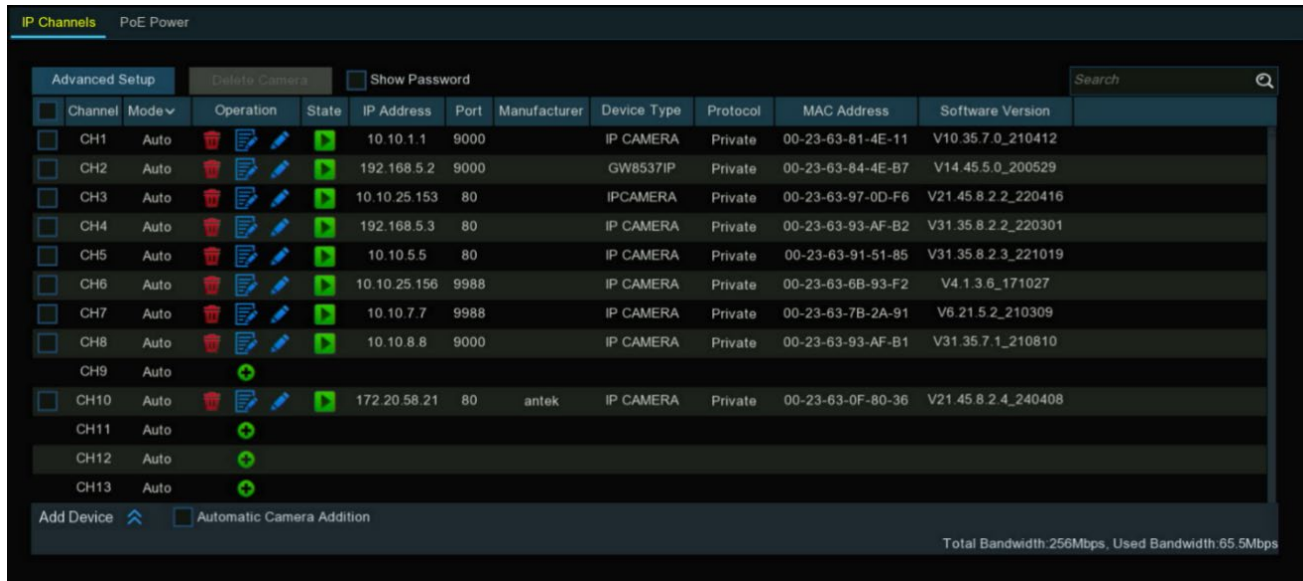

If your connected IP camera doesn't support plug-and-play or requires manual addition, you can follow these steps:

1. Clicking the icon next to "Add Device" expands the device IP camera search window, while clicking the icon collapses the search window.

Click the "Search" button to search and display devices on the same LAN.

2. Based on the search results, if multiple devices are selected and the IP addresses of the cameras are not in the same subnet as the NVR, you can click on "Batch IP Modification" to modify the IP addresses of the selected cameras in batch.

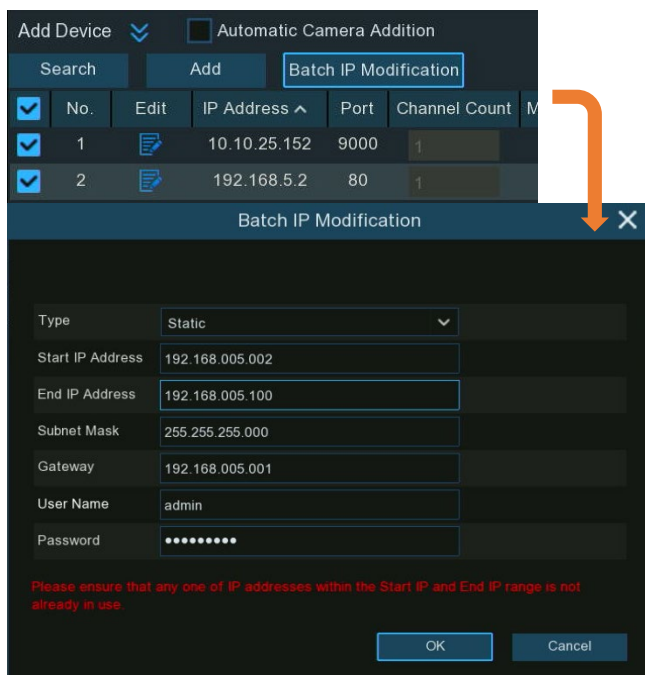

Note: After the modifications are complete, please perform another search to discover the devices with the updated IP addresses, and then select the cameras to add.

3. Based on the search results, select one or multiple devices, click "Add," and enter the corresponding information to complete the addition.

- If you're adding an IP camera using a private protocol connection, you can use the default parameters, including port, protocol, username, and password.
- If you're adding a third-party IP camera connected via ONVIF, please select the ONVIF protocol and enter the correct username and password for the IP camera to proceed with the addition. Once the settings are configured, click on "Add" to proceed with the addition.

4. You can also click on the  button in a channel within the list to manually add an IP Camera to that channel.

No.	Edit	IP Address	Port	Manufacturer	Activation State	Device Type	MAC Address
1		192.168.5.2	9000		None	GW8537IP	00-23-63-84-4E-B7
2		192.168.5.3	80		Activated	IP CAMERA	00-23-63-93-AF-B2

If the IP Camera you want to add is on the same local network as the NVR, you can click on "Search" to find the IPC. Then, in the search results, click on the IP Camera you want to add, enter the username and password, and click "Add" to proceed. If its password matches the default password set on the NVR for IP Cameras, you can also check "Connect with default password" for the system to automatically input the password.

5. If the IP Camera you want to add is not on the local network but on the Internet, you can manually enter the network information for that IPC and then proceed with the addition.
6. When "Automatic Camera Addition" is checked, the NVR will automatically search for IP Cameras that can be added within the local network and add them to the unoccupied channels.

5.1.1.2 Camera Protocol

NVR supports connecting to IP cameras via 3 different protocols: Private, ONVIF, and RTSP. Through these 3 protocols, you can connect to the majority of IP cameras available on the market.

- **Private:** NVR and IP cameras use the same protocol, enabling plug-and-play functionality and utilizing advanced features such as AI.
- **Onvif:** ONVIF (Open Network Video Interface Forum) is a global standard for the interface of physical IP-based security products, which allows interoperability between different manufacturers' devices. When connecting to a third-party IP camera that supports ONVIF, please select this protocol for connection. It supports basic settings for IP cameras through the ONVIF protocol, such as bitrate, frame rate, color, etc.
- **RTSP:** The RTSP (Real-Time Streaming Protocol) allows the NVR to access the audio and video streams from the IP camera for real-time preview and recording purposes. However, it does not allow the NVR to perform configuration settings on the IP camera. If the third-party IP camera you are connecting to does not support the ONVIF protocol, you can try using RTSP for connection.

When adding an IP camera, you can select the appropriate protocol based on the IP camera being connected.

IP Address/Hostname	172.16.3.3
Alias	CH2
Port	80
Protocol	Private
User Name	admin
Password	

If you use ONVIF for connection, the system will present a "Connect Mode" option, where you can choose between "General" or "Security". Choosing "General" will connect via the HTTP port to ONVIF, while selecting "Security" will connect via the HTTPS port.

Note: If the camera does not support HTTPS, it will automatically switch to using the HTTP port.

IP Address/Hostname	172.16.3.3
Alias	CH2
Port	80
Protocol	Onvif
Connection Mode	Security
User Name	admin
Password	

5.1.1.3 Editing and Deleting IP Camera

When you need to edit or delete an already added IP Camera, you can perform the following steps:

1. In the list of added IP Cameras, click on the  icon of the camera you want to edit, and you can modify the IP address of that camera.

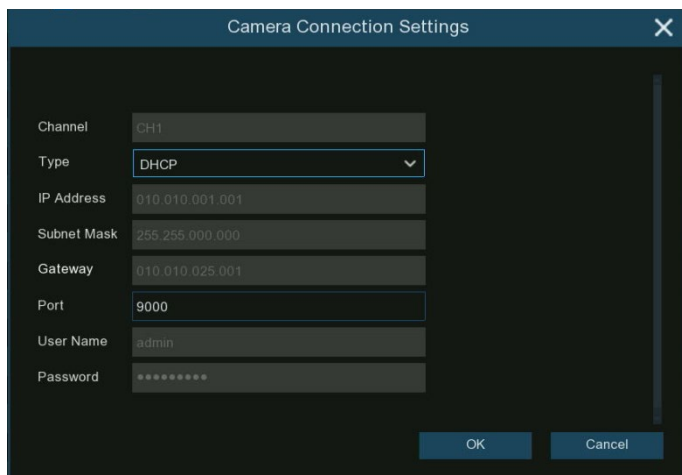



You can choose either DHCP or Static mode for the IP address assignment.

- Selecting DHCP mode means that if the IP camera is directly connected to the PoE port of the NVR, its IP address will be automatically assigned by the NVR. If the IP Camera is connected to an external router, its IP address will be assigned by the router.
- Choosing Static mode requires you to manually configure an IP address for the IP Camera.



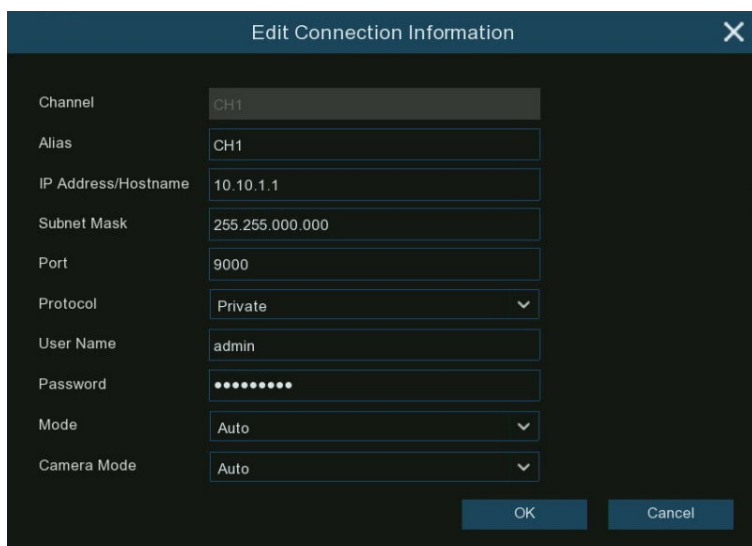





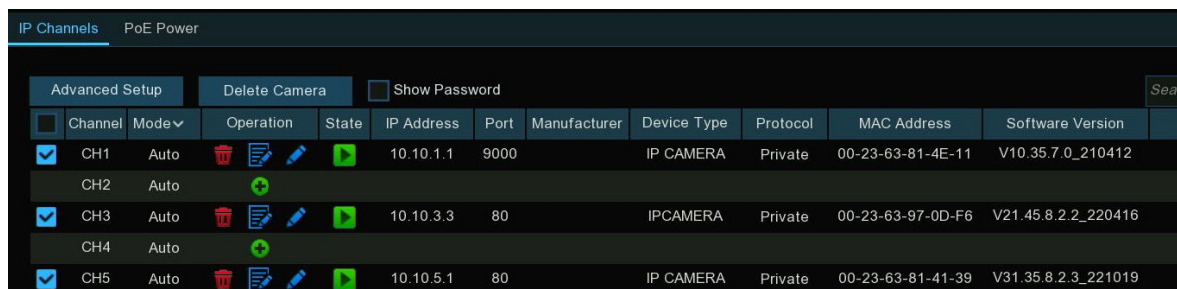





Simultaneously, you can also modify the communication port of the IP Camera.

2. If the connected IP Camera has changed its IP address, port, username, or password, and you need to update it with the correct information, or if you need to replace the connected IP Camera with another IP camera at a different IP address, you can click on the  icon to modify the connection information



3. If you need to delete an IP camera from a specific channel, you can directly click on the delete icon  of that channel to remove it. If you need to delete multiple IP Cameras from multiple channels, you can check the boxes in front of the channels you want to delete, then click on the "Delete Camera" icon at the top.











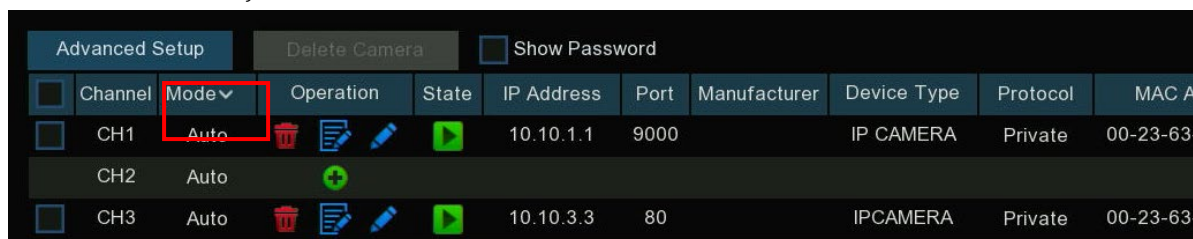

Channel	Mode	Operation	State	IP Address	Port	Manufacturer	Device Type	Protocol	MAC Address	Software Version
<input checked="" type="checkbox"/> CH1	Auto	  		10.10.1.1	9000		IP CAMERA	Private	00-23-63-81-4E-11	V10.35.7.0_210412
<input type="checkbox"/> CH2	Auto									
<input checked="" type="checkbox"/> CH3	Auto	  		10.10.3.3	80		IPCAMERA	Private	00-23-63-97-0D-F6	V21.45.8.2.2_220416
<input type="checkbox"/> CH4	Auto									
<input checked="" type="checkbox"/> CH5	Auto	  		10.10.5.1	80		IP CAMERA	Private	00-23-63-81-41-39	V31.35.8.2.3_221019

5.1.1.4 PoE Mode

NVR provides two PoE modes to accommodate IP Camera connections at different distances. When your IP Camera is directly connected via PoE using a cable shorter than 120 meters, you can use the Auto mode for up to 100Mbps data transmission. If your IP Camera is connected directly via PoE using a cable longer than 120 meters, it is recommended to use the ePoE mode for transmission. Under the ePoE mode, PoE connections up to 230 meters are supported, with a maximum bandwidth limited to 10Mbps.

You can click on the dropdown arrow next to "Mode" in the IP Camera display list to configure all channels uniformly to either Auto mode or ePoE mode.



Channel	Mode	Operation	State	IP Address	Port	Manufacturer	Device Type	Protocol	MAC Address
<input type="checkbox"/> CH1	Auto	  		10.10.1.1	9000		IP CAMERA	Private	00-23-63-81-4E-11
<input type="checkbox"/> CH2	Auto								
<input type="checkbox"/> CH3	Auto	  		10.10.3.3	80		IPCAMERA	Private	00-23-63-97-0D-F6

You can also click on the edit button  for an individual channel, then select the desired PoE mode from the "Mode" dropdown in the popped-up editing page.

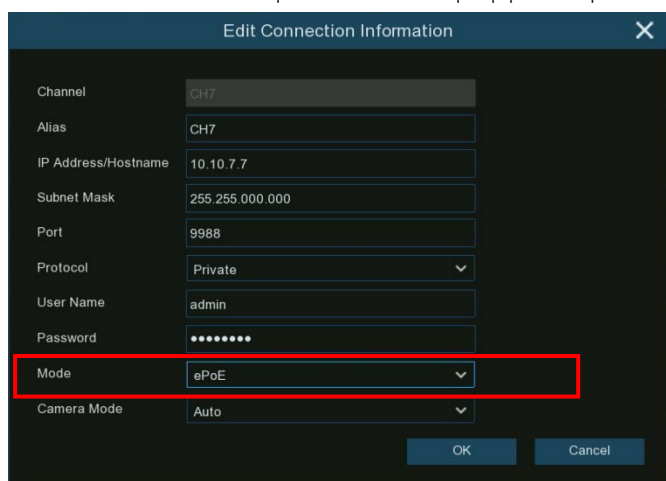

Channel: CH7

Alias: CH7

IP Address/Hostname: 10.10.7.7

Subnet Mask: 255.255.000.000

Port: 9988

Protocol: Private

User Name: admin

Password:

Mode: ePoE

Camera Mode: Auto

OK Cancel

5.1.1.5 Advanced Setup

In the Advanced Setup menu, you can perform actions such as setting default passwords, changing camera passwords, configuring PoE channel online priorities, resetting IP channel connections, and importing/exporting camera settings.

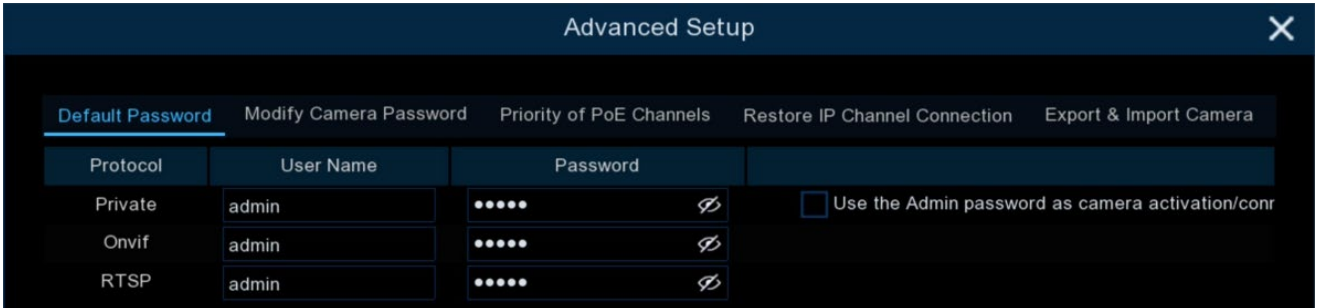

- **Default Password**

Set the default password for connecting cameras to NVR via the Private/Onvif/RTSP protocols. The default password for the Private protocol can be used to activate inactive cameras that are connected.

When "Use the Admin password as camera activation/connection password" is checked, the Private protocol will use the device administrator password to activate/connect to the connected cameras.

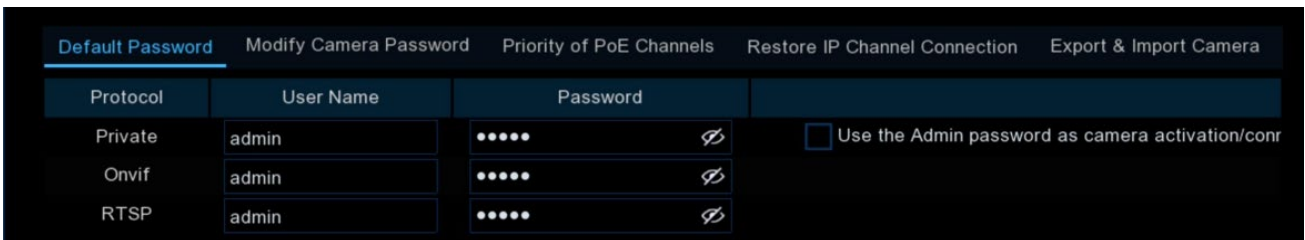

- **Modify Camera Password**

You can change the password for all online IP Cameras here.

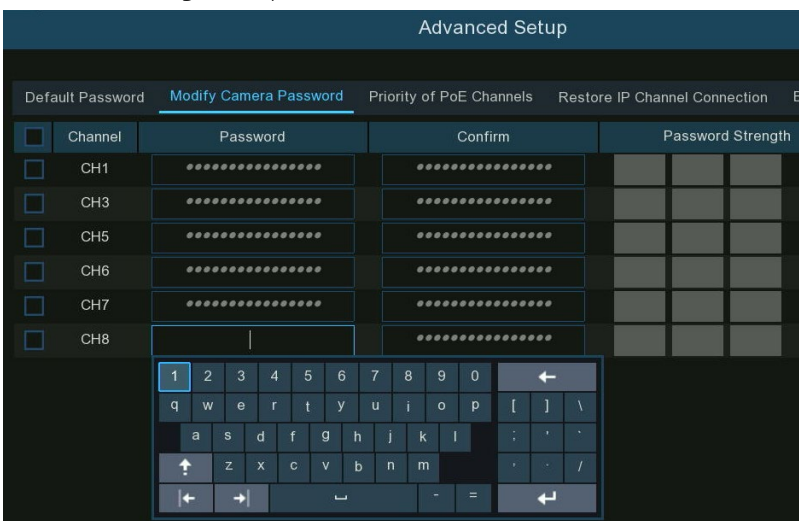

Click on the input box for the IP Camera whose password you want to change, enter the new password, then confirm it by entering the same password again. After that, click the "Apply" button to save the changes. You can also use the "Copy" button to copy the password of one IP Camera to other IP Cameras.

● Priority of PoE Channels

If your NVR has PoE interfaces, you can customize the online priority of IP Cameras connected to PoE channels.

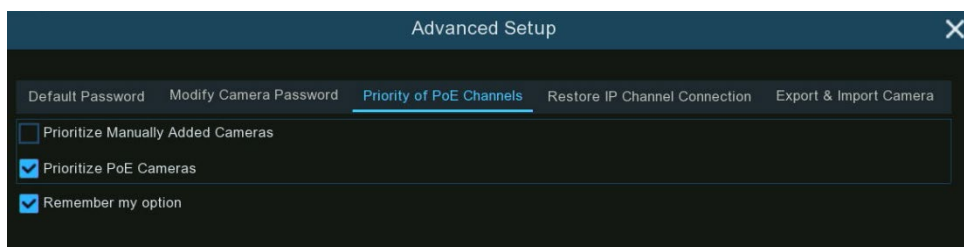

- **Prioritize PoE Cameras:** If a channel already has manually added cameras and you connect a camera to the corresponding PoE port, the previously manually added cameras will be replaced by the PoE-connected camera. (Unchecked "Remember my option" effective for one time only).
- **Prioritize Manually Added Cameras:** If a channel already has manually added cameras and you connect a camera to the corresponding PoE port, the previously manually added cameras will not be replaced by the PoE-connected camera. (Unchecked "Remember my choice", effective for one time only).
- If no priority item is selected, when a channel already has manually added cameras and you connect a camera to the corresponding PoE port, a dialog box will prompt that there are already cameras on the channel and ask if you want to replace it.

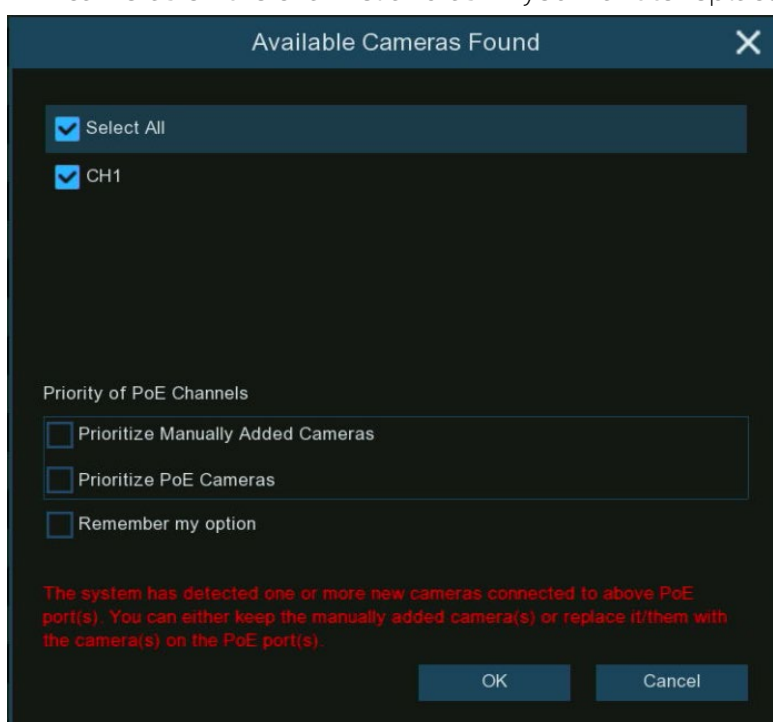

You can choose to "[Prioritize Manually Added Cameras](#)" to keep the previously manually added IP Cameras, or you can select "[Prioritize PoE Cameras](#)" to let the PoE-connected IP Cameras replace the previously manually added ones.

- **Restore IP Channel Connection**

Every time a new IP Camera is added and comes online on the NVR, the system automatically records and saves the connection information of the added IP Cameras. If your NVR is reset to factory settings, you can click the "Restore IP Channel Connection" button in this menu to restore the connection of IP Cameras.

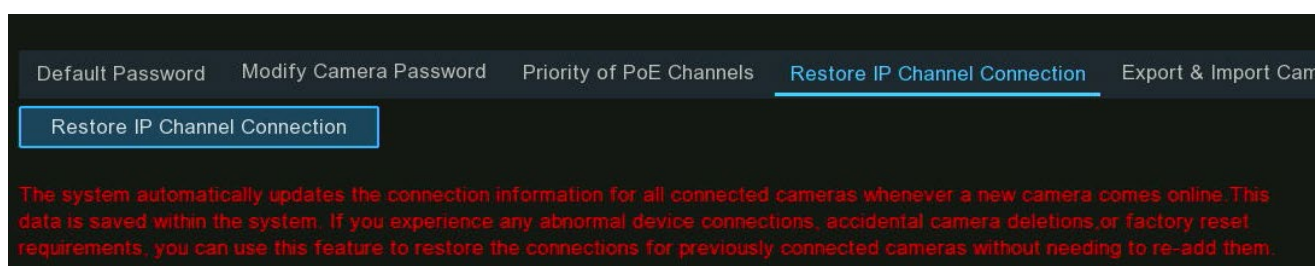

- **Export & Import Camera**

Clicking on "[Export Camera](#)" allows you to export the information of added IP Cameras to a USB drive as a backup. This backup can be used for importing after the NVR is reset to factory settings or for importing into other NVR. Please note that the exported information does not include connection passwords. When importing again, you will need to input the passwords for the cameras.

5.1.1.6 PoE Power

In this page, you will find the real-time power consumption of each PoE port, total actual power & rated power.

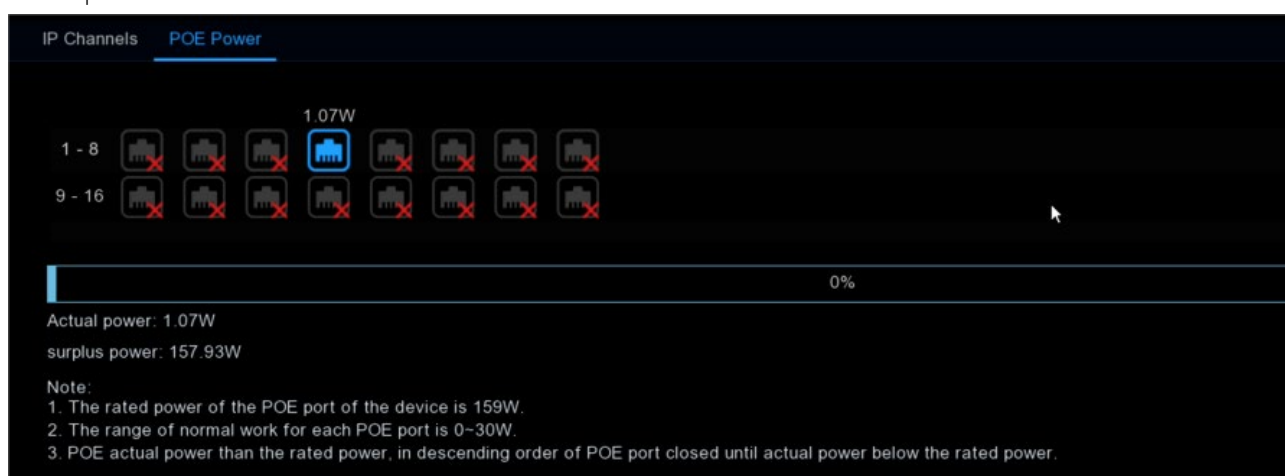

Actual power: Real-time power consumption in use

Surplus power: Remaining total power consumption

Notes:

1. The total rated power of the PoE interface varies for different models of NVR.
2. The normal operating range of each PoE port is 0 to 30w.
3. If the actual power of a PoE port exceeds the rated power, the PoE ports will be successively shut down in order until the actual power of the PoE port is below the rated power.

5.1.2 Live

On this page, you can configure the preview live image parameters displayed by the camera, such as channel name, time, date, refresh rate, etc.

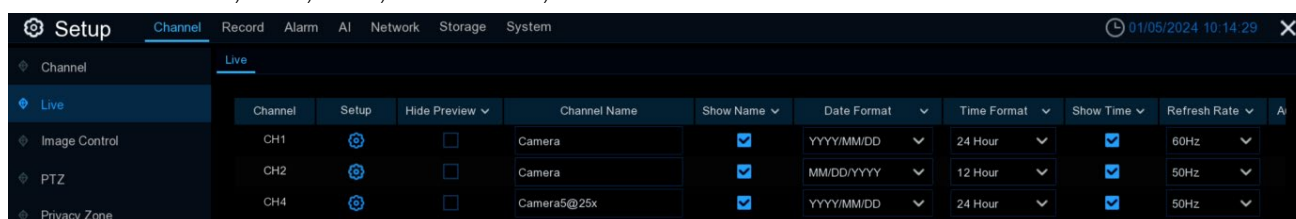

You can set up individual configurations for each channel or apply uniform settings to all online IP cameras using the dropdown menu next to each menu title bar.

Hide Preview: Checking this option will hide the real-time preview image of this channel, but it will not affect the recording of this channel.

Channel Name: This option allows you to set the name of the channel, which is displayed as an identifier for the camera.

Date Format: Choose the format in which the date is displayed on the on-screen display (OSD) of the IP camera. Formats include variations like YYYY/MM/DD, MM/DD/YYYY, or DD/MM/YYYY, depending on your preference or regional standards.

Time Format: Select the format in which the time is displayed on the OSD of the IP camera. Formats could include 24-hour or 12-hour formats, depending on your preference.

Refresh Rate: Please select according to your local power supply environment.

Show Time: Enabling this option will display the current time on the camera's preview image and recording images. It provides temporal context to the captured footage and can be useful for referencing events.

Auto Text Color: This option adjusts the OSD font color automatically to ensure clear visibility against varying background colors on the screen. This feature requires support from the IP camera.

Clicking on the settings button  of an individual channel allows you to make the following configurations.

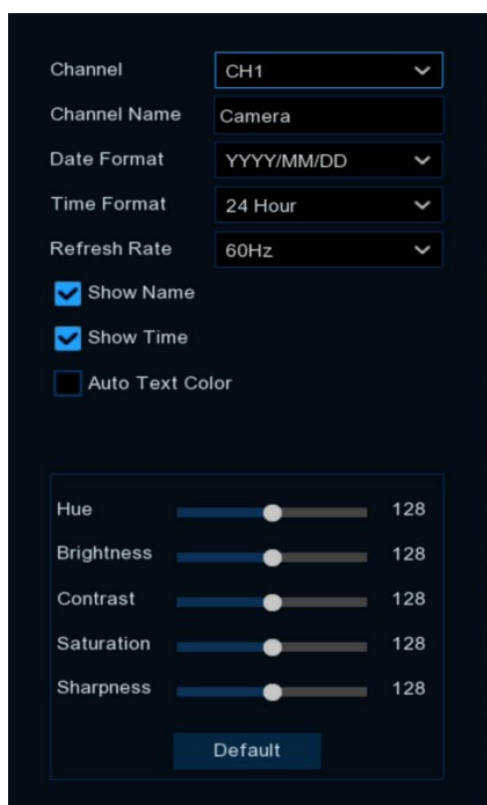

Channel Name: Set the channel name.

Date Format: Choose the format in which the date is displayed on the on-screen display (OSD) of the IP camera.

Time Format: Select the format in which the time is displayed on the OSD of the IP camera.

Refresh Rate: Select according to your local power supply environment.

Show Name: Enabling this option will display the channel name on the camera's preview image and recording images.

Show Time: Enabling this option will display the current time on the camera's preview image and recording images.

Auto Text Color: Enabling this option will adjust the OSD font color automatically.

Hue: Adjusts the color tone of the image

Brightness: Adjusts the brightness level of the image

Contrast: Adjusts the contrast level of the image

Saturation: Adjusts the saturation level of the image, affecting the intensity of colors

Sharpness: Adjusts the sharpness of the image, controlling the clarity and definition of edges and details

Default: Restores the image parameters to their default values

5.1.3 Image Control

This menu enables you to adjust image settings for compatible IP cameras. However, if the camera is connected to the NVR using the ONVIF protocol, configuration settings might not be supported.

The screenshot shows the NVR Setup menu with the 'Image Control' sub-menu selected. The settings are as follows:

Channel	Setup	Image Mode	IR-CUT Mode	Vertical Flip	Horizontal Flip	Angle Adjustment	BLC Level	3D Noise Reduction	DWDR	AGC	White Balance	Shutter Speed	Def.
CH1		Full Color Mode		OFF	OFF	0	OFF	Auto	OFF		Auto	Auto	
CH2			Image Control	OFF	OFF	0	OFF	Auto	128		Auto	Auto	
CH4			Image Control	OFF	OFF	180	OFF	Auto	128		Auto	Auto	
CH5			GPIO Auto	OFF	OFF	0	OFF	Auto	OFF		Auto	Auto	

Click on the settings icon of the channel you want to adjust the image for, to access the configuration page.

Please note: Depending on the different models of IP Cameras, you will see different function menus. The following lists all possible menus and does not imply that your IP Camera will have this menu.

5.1.3.1 Image Control for Standard Day/Night Cameras

For a standard day/night IP Camera, the following settings could be configured:

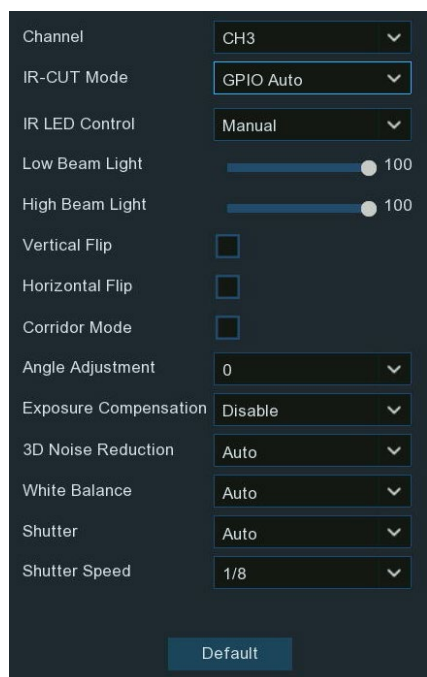

IR-CUT Mode: Lets you choose how the camera handles image color and manages the transition between daytime and nighttime:

- **Full Color Mode:** Forced Color mode that will not switch to black and white.
- **Day/Night or Black/White Mode:** Forced B/W mode that will not switch to color.
- **Smart Illumination:** Smart lighting mode, when the ambient illumination is insufficient, there is an alarm trigger fill light / red and blue light on, and the alarm end fill light / red and blue light off.
- **Image File(s) or Image Control:** The transition from color to black & white and black & white to color is determined by image analysis (for non-photosensitive camera). If you enable this

feature, you can set the sensitivity of the IR-Cut filter. The value ranges from 0 to 3, with higher values making the IR-Cut filter more responsive to ambient light levels.

- **Schedule or B/W Schedule:** Used to switch between black & white and color according to a schedule. If this function is enabled, the start time and end time for night vision must be set.

IR LED Control: This setting determines how the infrared (IR) illuminator on the camera operates during night vision mode. Depending on your IP camera model, you may encounter the following menu options. Please make the appropriate selection based on the actual menu of your device:

- **Auto:** Used to automatically control the switching mode. The transition from color to black and white is determined by image analysis, and from black and white to color by light sensitivity to ambient light.
- **On:** Forces the IR illuminator to turn on and provide constant fill-in lighting, regardless of lighting conditions.
- **Off:** Disables the IR illumination completely. No fill-in light will be applied.
- **Manual:** Manual mode allows you to set the brightness level of the IR illumination directly.
 - **Low Beam Light:** This allows you to manually control the brightness of the first set of IR lamps from 0 to 100. A value of 0 turns the IR lamps off, while 100 sets them to maximum brightness.
 - **High Beam Light:** This allows you to manually control the brightness of the second set of IR lamps (if supported by your camera model) from 0 to 100. A value of 0 turns these IR lamps off, while 100 sets them to maximum brightness.

- **Smart IR:** This feature intelligently adjusts the infrared (IR) illumination intensity based on the camera's focal length and overexposure conditions. It helps provide optimal illumination and prevents overexposure during night vision mode.

Vertical Flip: Flips the image upside down.

Horizontal Flip: Mirrors the image horizontally.

Corridor Mode: Optimizes the camera's vertical viewing angle for monitoring long, narrow scenes like hallways or corridors. Enable this mode if your camera is aimed along a corridor.

Angle Trad: Allows setting the flip angle.

Exposure Compensation: Provides 4 modes for adjusting exposure levels:

- **WDR:** Wide dynamic range in which the picture is uniformly balanced based on the setting and both light and dark areas can be clearly distinguished. (DWDR here for some models)
- **HLC:** Highlight compensation in which the objects in the highlighted area are clearer in the picture. (applicable for some models).
- **Back Light:** Backlight compensation in which the objects in the dark area are clearer.
- **Disable:** An image will not be optimized with backlight on.

3D Noise Reduction: Reduces image noise for a clearer picture. Three modes:

- **Auto:** Camera automatically applies noise reduction algorithms.
- **OFF:** Disables noise reduction.
- **Manual:** Allows manually setting the noise reduction level.

White Balance: Adjusts color temperature. Two modes:

- **Auto:** Camera automatically adjusts white balance using default parameters
- **Manual:** Allows manually setting levels of red, green, and blue color channels.
- **Indoor:** Sets white balance for typical indoor lighting conditions. (Only applicable for certain supported models)

Shutter: Sets the shutter speed exposure time. Two modes:

- **Auto:** Camera automatically selects exposure time based on the Time Exposure value.
- **Manual:** Uses the manually configured Time Exposure value.

Time Exposure: Sets the exposure time to use in conjunction with the Shutter setting. If the Shutter mode is set to Manual, this value determines the fixed shutter speed. If the Shutter mode is set to Auto, this value sets the slowest shutter speed limit. The camera will automatically select the most suitable shutter speed between this slowest limit and the fastest speed displayed by the system for proper exposure. For example, if set to 1/30, the shutter speed will automatically adjust within the range of 1/30 to 1/20000 for optimal exposure.

AGC: Adjusts Automatic Gain Control levels to boost sensor gain in low-light, ensuring proper exposure and preventing underexposure. (Manual adjustment supported on some models.)

Defog Mode: Optimizes visibility on foggy days. Three modes:

- **Disable:** Disables defog functionality.
- **Auto:** Camera automatically applies defogging.
- **Manual:** Allows manually setting the defog level.

Default: Click this button to restore the factory default settings for all image parameters.

5.1.3.2 Image Control for Full Color Cameras

For a full color IP Camera, the following settings could be configured:

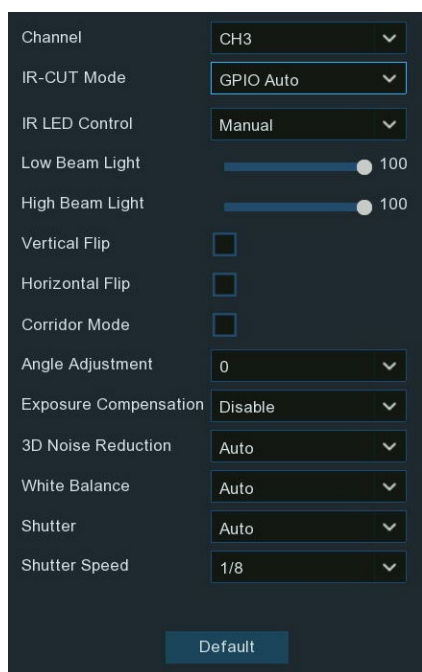

Image Mode: Set the camera's image mode, with 3 modes available:

- **Day/Night Mode:** When ambient lighting is insufficient, the infrared illuminator will turn on according to settings to provide fill lighting, and the image will be displayed in black and white. If you select this mode, please refer to the instructions in [5.1.3.1 Image Control for Standard Day/Night Cameras](#) for specific parameter settings.

- **Smart Illumination:** After selecting this mode, the camera will use the IR illuminator for fill lighting during night vision, displaying the image in black and white. When an alarm is triggered, it will activate the white light illuminator for fill lighting, and the image will switch to color. When the alarm ends, the

camera will switch back to using the IR illuminator, and the image will revert to black and white.

This feature is only applicable to certain supported models.

- **Full Color Mode:** When ambient lighting is insufficient, the white light illuminators will turn on according to settings to provide fill lighting, and the image will remain in color mode. In this mode, you can configure how the white light illuminator turns on and its sensitivity settings.

White Light: In Full Color Mode, you can set how the white light illuminator operates for fill lighting and adjust its brightness level. There are 4 modes:

- **Automatic:** The camera will automatically turn on the white light illuminator and adjust its intensity based on the ambient lighting conditions.
- **Manual:** Manually adjust the brightness of the white light illuminator for fill lighting by configuring the Sensitivity and Light Distance settings.
- **OFF:** Disables the white light illuminator.

Sensitivity: Set from 0-3, this adjusts how sensitive the camera is to ambient light levels when triggering the white light illuminator. Higher values mean brighter ambient light is required to turn it on

Light Distance: Range from 0-100, higher values increase the brightness of the white light illuminator.

Vertical Flip: Flips the image upside down.

Horizontal Flip: Mirrors the image horizontally.

Corridor Mode: Optimizes the camera's vertical viewing angle for monitoring long, narrow scenes like hallways or corridors. Enable this mode if your camera is aimed along a corridor.

Angle Trad: Allows setting the flip angle.

Exposure Compensation: Provides 4 modes for adjusting exposure levels:

- **WDR:** Wide dynamic range in which the picture is uniformly balanced based on the setting and both light and dark areas can be clearly distinguished. (DWDR here for some models)
- **HLC:** Highlight compensation in which the objects in the highlighted area are clearer in the picture. (applicable for some models).
- **Back Light:** Backlight compensation in which the objects in the dark area are clearer.
- **Disable:** An image will not be optimized with backlight on.

3D Noise Reduction: Reduces image noise for a clearer picture. Three modes:

- **Automatic mode:** Camera automatically applies noise reduction algorithms.
- **OFF:** Disables noise reduction.
- **Manual:** Allows manually setting the noise reduction level.

White Balance: Adjusts color temperature. Two modes:

- **Auto:** Camera automatically adjusts white balance using default parameters.
- **Manual:** Allows manually setting levels of red, green, and blue color channels.
- **Indoor:** Sets white balance for typical indoor lighting conditions. (Only applicable for certain supported models)

Shutter: Sets the shutter speed exposure time. Two modes:

- **Auto:** Camera automatically selects exposure time based on the Time Exposure value.
- **Manual:** Uses the manually configured Time Exposure value.

Time Exposure: Sets the exposure time to use in conjunction with the Shutter setting. If the Shutter mode is set to Manual, this value determines the fixed shutter speed. If the Shutter mode is set to Auto, this value sets the slowest shutter speed limit. The camera will automatically select the most suitable shutter speed between this slowest limit and the fastest speed displayed by the system for proper exposure. For example, if set to 1/30, the shutter speed will automatically adjust within the range of 1/30 to 1/20000 for optimal exposure.

AGC: Adjusts Automatic Gain Control levels to boost sensor gain in low-light, ensuring proper exposure and preventing underexposure. (Manual adjustment supported on some models.)

Defog Mode: Optimizes visibility on foggy days. Three modes:

- **OFF:** Disables the white light illuminator.

- **Disable:** Disables defog functionality.
- **Auto:** Camera automatically applies defogging.
- **Manual:** Allows manually setting the defog level.

Default: Click this button to restore the factory default settings for all image parameters.

5.1.3.3 Image Control for Thermal Cameras

If you have connected a thermal imaging IP camera, you can configure the following settings for the camera.

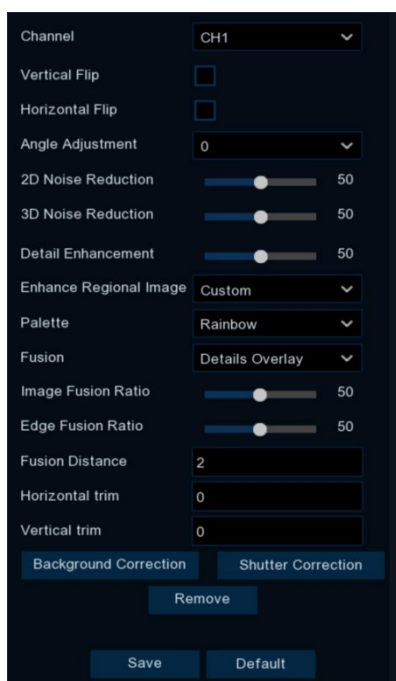

Vertical Flip: Flips the image upside down.

Horizontal Flip: Mirrors the image horizontally.

Angle Trad: Allows setting the flip angle.

2D Noise Reduction: Reduce the noise in the thermal channel screen according to the manually set noise reduction parameters, the larger the parameter value, the more obvious the noise reduction effect and the clearer the image screen.

3D Noise Reduction: Reduce the noise in the thermal channel according to the manually set noise reduction parameters, the larger the parameter value, the more obvious the noise reduction effect and the clearer the image.

Detail Enhancement: Enhances the detail in the thermal imaging channel image based on manually set parameters. Higher

parameter values increase the detail enhancement effect for a sharper image.

Enhance Regional Image: Select a region option or customize a region to enhance the image effect of the corresponding area in the thermal imaging channel, making the image brighter.

Palette: Sets the pseudo-color mode for the thermal imaging channel, using different colors to represent temperature differences.

Fusion: You can choose whether or not to fuse and overlay the optical channel image onto the thermal imaging channel image.

- **Normal:** The optical channel and thermal channel images are displayed independently without fusion.
- **Details Overlay:** Fuses the optical channel image onto the thermal channel, allowing the thermal image to display more details from the optical image.

Image Fusion Ratio: The ratio between the optical channel and thermal channel images. Higher parameter values increase the ratio of the optical channel image, making the fused image appear closer to the optical image effect. Conversely, lower values make the fused image closer to the original thermal image effect before fusion.

Edge Fusion Ratio: The higher the parameter value, the sharper the edges of objects in the fused image. Lower values make edges more blurred.

Fusion Distance: The distance for fusing the optical channel and thermal channel images.

Horizontal trim: Horizontal adjustment, adjusts the horizontal position of the optical channel image relative to the thermal channel in the fused view.

Vertical trim: Vertical adjustment, adjusts the vertical position of the optical channel image relative to the thermal channel in the fused view.

Background Correction: Optimizes the thermal imaging channel image effect by setting a uniform temperature barrier in front of the lens, like uniform foam or cardboard completely blocking the thermal lens. The device optimizes the image once using this uniform blocker as reference.

Shutter Correction: Manual correction to optimize the thermal imaging channel image effect.

5.1.4 PTZ

This menu allows you to configure the PTZ (Pan/Tilt/Zoom) settings for the speed dome cameras.

PTZ							
Channel	Signal Type	Protocol	Baudrate	DataBit	StopBit	Parity	Address
CH1	Analog	Pelco-D	9600	8	1	None	1
CH9	Digital	Pelco-D	9600	8	1	None	9
CH10	Digital	Pelco-D	9600	8	1	None	10

Signal Type: If your PTZ camera is connected to the RS485 port, then choose "Analog", otherwise choose "Digital".

The following items are available only for Analog PTZ cameras:

Channel	Signal Type	Protocol	Baudrate	DataBit	StopBit	Parity	Address
CH1	Digital	Pelco-D	9600	8	1	None	1
CH2	Analog	Pelco-D	1200	8	1	None	2

Protocol: Choose the communication protocol between the PTZ-enabled camera and the NVR.

Baudrate: The speed at which data is transmitted from the NVR to the PTZ camera. Ensure it matches the supported baud rate of your PTZ camera.

DataBit / StopBit: Data between the NVR and PTZ camera is sent in individual packets. The Data Bit indicates the number of bits in each data packet, while the Stop Bit signals the end of one packet and start of the next. Available Data Bit options are: 8, 7, 6, 5. Available Stop Bit options are 1 or 2.

Parity: For error checking. Refer to your PTZ camera's documentation to configure this setting properly.

Address: Set the command address for the PTZ system. Note that each PTZ camera requires a unique address to function correctly.

The following menu options are only applicable to supported PTZ IP cameras:

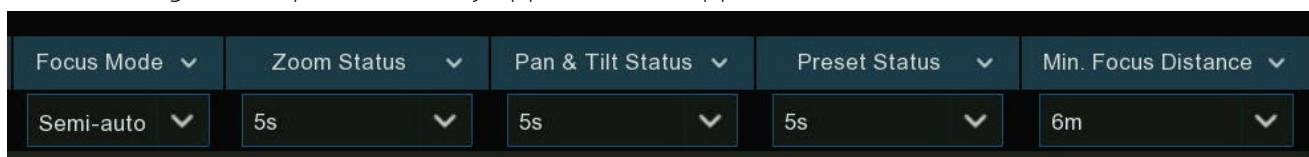

Focus mode: There are three focus modes available:

- **Auto:** Automatically focuses based on scene changes.
- **Semi-auto:** Default mode. Focuses once after panning or zooming, and does not refocus with scene changes.
- **Manual:** The user manually focuses using the focus buttons on the preview interface. Panning, zooming, and scene changes do not trigger refocusing.

Zoom Status: The zoom status of the camera. The zoom level is displayed in the lower left corner of the preview interface. You can choose whether to display it or how long to display it.

Pan & Tilt Status: In the lower left corner of the preview screen, the horizontal and vertical azimuth of the camera will be displayed. You can choose whether or not to display it or how long to display it.

Preset Status: The preset status of the camera. The preset point number is displayed in the lower left corner of the preview interface when a preset is called. You can choose whether to display it or how long to display it.

Min. Focus Distance: When the distance between the scene object and the lens is less than the minimum focus distance, the lens will not change the focus on that object and will prioritize focusing on objects at distances greater than the "Minimum Focus Distance" parameter. For example, if the minimum focus distance is set to 6 meters, you can set a baffle at 1.5 meters to block part of the lens's field of view, with one half showing a distant view and the other a close view. The camera will prioritize focusing on the distant view beyond 6 meters.

5.1.4.1 Controlling Your MFZ Camera

You're able to adjust the optical lens to zoom in or zoom out if a MFZ (Motorized Focus & Zoom) camera is connected. In live viewing, click the left button of your mouse on a connected camera to pop up the Camera Quick Toolbar. Click the PTZ icon  to enter PTZ control panel.

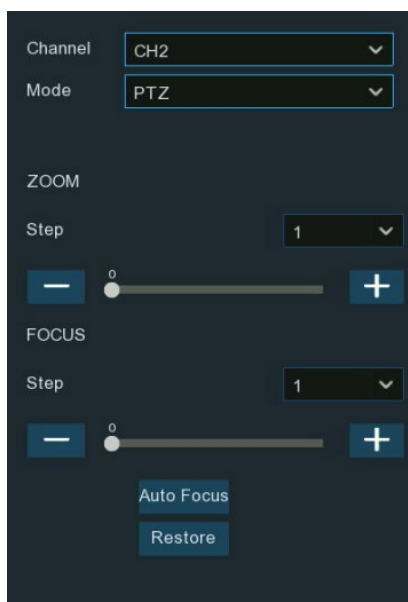

Zoom: To control zooming in and out

Step: To set the step size for each zoom in and zoom out movement of the lens.

 Click the button once to initiate a single zoom-out movement and auto-focus. Press and hold the button to continuously zoom out until you release the mouse button.

 Click the button once to initiate a single zoom-in movement and auto-focus. Press and hold the button to continuously zoom in until you release the mouse button.

If your camera supports a slider control, you can also directly drag the slider to adjust the zoom level.

Focus: To manually adjust the focus

Step: To set the step size for each focus adjustment of the lens.

 A single click on this button will cause the lens to focus outwards one step according to the set step size. Click and hold to continuously adjust the focus outwards.

 A single click on this button will cause the lens to focus inwards one step according to the set step size. Click and hold to continuously adjust the focus inwards.

If your camera supports a slider control, you can also directly drag the slider to adjust the focus

Auto Focus: Automatically focuses the camera on objects in the scene.

Restore: Returns the camera to its default settings and zoom/focus levels.

5.1.4.2 Controlling Your PTZ Camera

In live viewing, click the left button of your mouse on the PTZ camera to pop up the Camera Quick Toolbar. Click the PTZ button  to enter PTZ control panel.

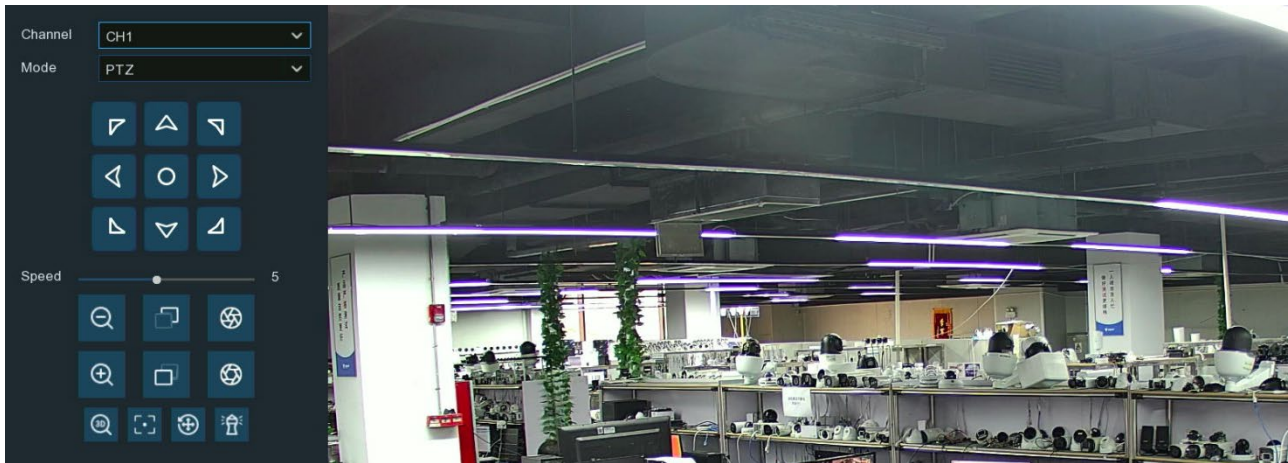

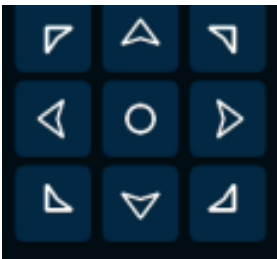

Mode: Select the method supported by the IP Camera for controlling PTZ.

Direction Control Buttons:



Clicking any of the 8 directional arrows will cause the camera's pan/tilt to make a slight movement in the corresponding direction.

Holding down one of the arrows will result in continuous rotation in that direction for the camera's pan/tilt. Clicking the center button  initiates continuous horizontal rotation, and the button will change to  during this action. Clicking it again will stop the rotation.

Lens Control Buttons:

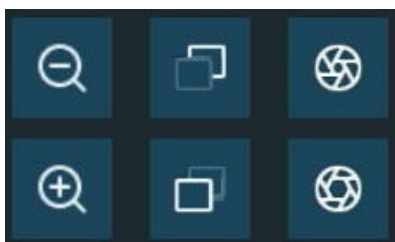



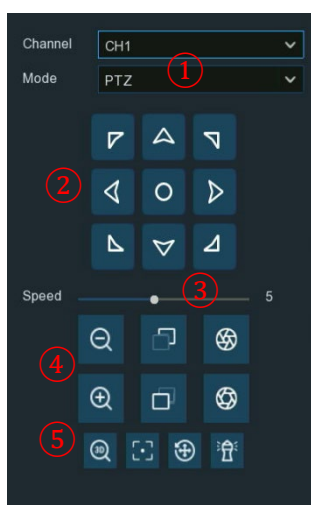

Icon	Function	Description
	Zoom Out	Clicking the key causes the lens to slightly zoom out, slightly shrinking the scene. Holding down the "-" key continuously zooms out the lens, resulting in continuous shrinking of the scene.
	Zoom In	Clicking the key causes the lens to slightly zoom in, slightly enlarging the scene. Holding down the "+" key continuously zooms in the lens, resulting in continuous enlargement of the scene.
	Focus Near	In manual focus mode, press and hold down the button to focus on near objects, making them clear while distant objects gradually become blurred;
	Focus Far	In manual focus mode, press and hold down the "Far" button to focus on distant objects, making them clear while near objects gradually become blurred.
	Iris +	When the monitoring image appears relatively dark, you can hold down the button to increase the iris opening and let in more light. (Supported on select models only)
	Iris -	When the monitoring image appears relatively bright, you can hold down the button to decrease the iris opening and reduce the amount of light entering. (Supported on select models only)

5.1.4.2.1 Controlling PTZ



1. Select **PTZ** mode.
2. Click the direction control buttons to rotate the camera.
3. To adjust the speed for panning or tilting.
4. To control the optical zoom, focus and iris of the lens.
5. Using function control buttons:



Icon	Function	Description
	3D Positioning	<p>Click to turn on 3D positioning, and the button icon will turn blue; click the button again to stop 3D positioning. When the camera's 3D positioning is enabled, you can perform the following operations:</p> <ul style="list-style-type: none"> □ Use the left mouse button to click on a specific point in the preview window, and the camera will move the clicked point to the center of the screen. □ Hold down the left mouse button and drag to the right to create a rectangular area, then release the button. The camera will move the outlined area to the center of the screen and zoom in for a closer view. □ Hold down the left mouse button and drag to the left to create a rectangular area, then release the button. The camera will move the outlined area to the center of the screen and zoom out for a wider view.
	Auto Focus	Click this button, and the camera will automatically focus
	One-click Reset	Clicking this button, the camera will clear all preset points and cruise paths
	Watch Mode	Activate and Deactivate Watch Mode.

5.1.4.2.2 Preset Points

In this section, you're able to configure the preset points. A preset point is a particular position within the image that you would like the camera to focus on. Up to 255 different preset points can be created.



1. Select **Preset Point** mode.
2. Adjust the speed control to alter how fast or slow the camera will pan or tilt.
3. Click and hold the direction control buttons to move the camera in the selected direction.
4. Change the optical zoom, focus and iris of the lens if needed.
5. When the position is fixed, change the length of time (in seconds) the camera will stay at this position, before moving to the next position.
6. Click the add button to create the preset point.
7. Repeat steps 1 to 6 to add more preset positions. The saved preset positions will be displayed with a blue background.
8. Click the GO TO button →, the camera will then move to that selected position.
9. Click **Start Cruise**, the camera will move to the preset positions in sequence. Click Stop Cruise to stop.

10. You can give a name to the preset position.
11. You can delete the preset position by clicking the Clear button .
12. Click the visual icon , you will see the thumbnail of the preset position displayed at the bottom of the live view image. You can go to, delete or add a preset position in the visual interface.

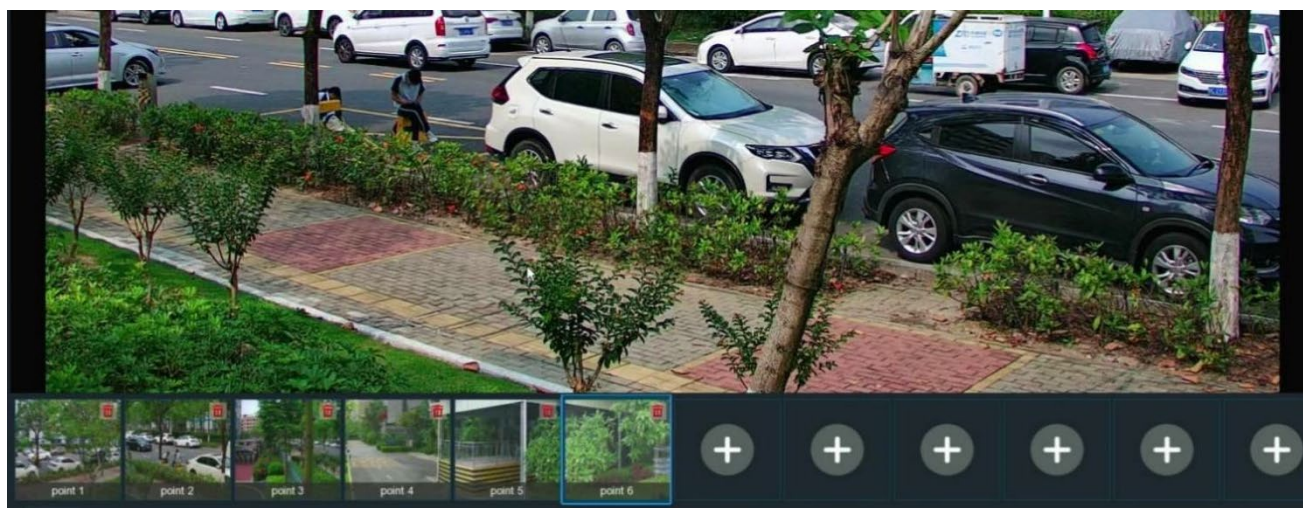



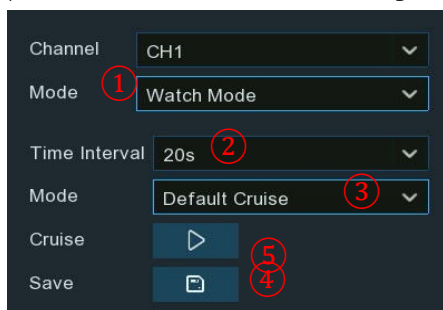

5.1.4.2.3 Watch Mode

The Watch Mode allows the camera to perform a preset action when there is no user operation for a period of time, such as moving to a preset position, starting the cruise sequence, etc.







1. Select the [Watch Mode](#).
2. Set the time interval. This means the length of time that must elapse before the watch mode action is triggered. For example, if the watch mode is activated and the interval is set to 15 seconds, the camera will perform the watching action if there are no user operations on the camera for 15 seconds.
3. Choose the action when the watch mode is activated:
 - [Default Cruise](#): The camera will continually rotate to the left
 - [Preset Position](#): The camera will move to a selected preset position and remain stationary
 - [Line Scan](#): The camera will implement the Line Scan function. See more details in Section 5.1.4.1.2.4 Line Scan.

- **Tour:** The camera will implement the Tour function. See more details in Section 5.1.4.1.2.5 Tour.
 - **Pattern Scan:** The camera will implement the Pattern Scan function. See more details in Section 5.1.4.1.2.6 Pattern Scan.
4. Click  button to save your changes.
 5. Click  button to start the Watch Mode. Press  button to stop.
 6. After you have completed setting up the Watch Mode, you can also click  button on the PTZ control page to turn the Watch Mode on and off.

5.1.4.2.4 Line Scan

Line Scan allows the camera to automatically pan horizontally between position A and position B.



1. Select **Line Scan** mode.
2. Adjust the speed control to alter how fast or slow the camera will pan or tilt.
3. Click and hold the directional buttons to move the camera in the selected direction.
4. Change the optical zoom, focus and iris of the lens if needed.
5. When the first position is fixed, click  button to record this as position A. Repeat steps 3 & 4 to move the camera to another position. Click  button to record the position as B.
6. Adjust the cruise speed.
7. Click  button to start Line Scan. Press  button to stop.

5.1.4.2.5 Tour

With the Tour function, you are able to configure a maximum of 4 tracks of automatic cruise sequences by selecting different preset points. To make full use of this Tour function, please ensure that several preset points have already been configured.

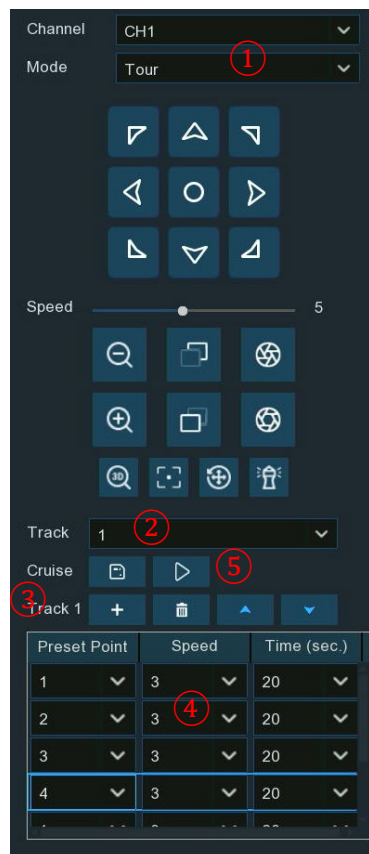





1. Select **Tour** mode.
2. Select a track.
3. Click the add button **+**, a position box will be added and displayed in the position list.
4. Click the box to choose a preset position. Set the dwell time in seconds for how long to remain at that preset point. Set the speed value for the transition to the next preset point (higher number = faster movement). Each track can have a maximum of 32 position boxes added. Click on the blank area beside a position box to delete it using the delete button **🗑️**, or click **▲** or **▼** button to reorder the sequence.
5. After adding all desired preset positions, click the save button to save the settings.
6. Click **💾** button to save. Click **▶** button to start Tour, click **⏏** button to end the tour.
7. Repeat steps 2-5 to configure up to 3 additional tour tracks.

5.1.4.2.6 Pattern Scan

This is a function that allows the camera to implement auto cruise by following a pre-record route.



1. Select **Pattern Scan** mode.
2. Select a track. Maximum 4 tracks available.
3. Adjust the speed control to alter how fast or slow the camera will pan or tilt.
4. Click and hold the directional buttons to move the camera in the direction selected.

5. Change the optical zoom, focus and iris of the lens if needed.
6. When the start position is fixed, click  button to start recording. Repeat step 4 & 5 to adjust the position. Press  to finish the recording of route.
7. Click  button, the camera will be moved exactly same as the route which was recorded in step 6, including zoom, focus, direction. Press  to stop.

5.1.4.3 Task Schedule

Click on the "Task Schedule" tab to set up a schedule for the PTZ camera tasks. The setup interface is shown in the following image. Users can configure the camera to automatically execute different tour tasks during different time periods.

Note: The Task Schedule feature requires PTZ camera support.

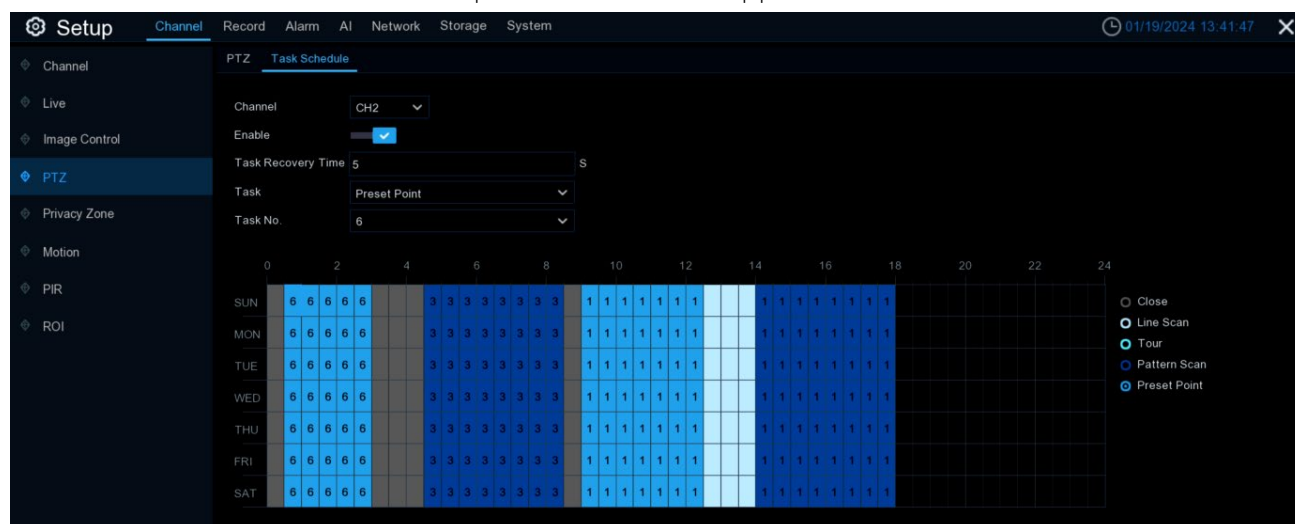

Enable: Turn on/off the scheduled PTZ camera task functionality. If the camera reaches the tour limits, there will be a corresponding prompt displayed to the right of the switch.

Tasks Recovery Times: The recovery time after a scheduled task is interrupted. When the camera is executing a scheduled tour and it gets interrupted by manual operation, after the recovery time elapses, the camera will automatically resume the scheduled tour task.

Tasks Type: The type of scheduled task. Task types include turning off, line scan, tour, pattern scan, and preset position. Tour and Pattern Scan each allow setting up to 4 different tracks. For Preset Point tasks, preset points 1-8 can be selected.

After selecting the appropriate Task and Task No., use the left mouse button to select the desired time slots on the 7x24 hour schedule grid. Then click "**Apply**" to save the scheduled tasks.

Note: Scheduled tasks take priority over the Watch Mode tasks.

5.1.5 Privacy Zone

This function can obscure all or part of your image for privacy (you can create up to 4 privacy masks per camera). Areas obscured by a mask won't be shown live or playback.

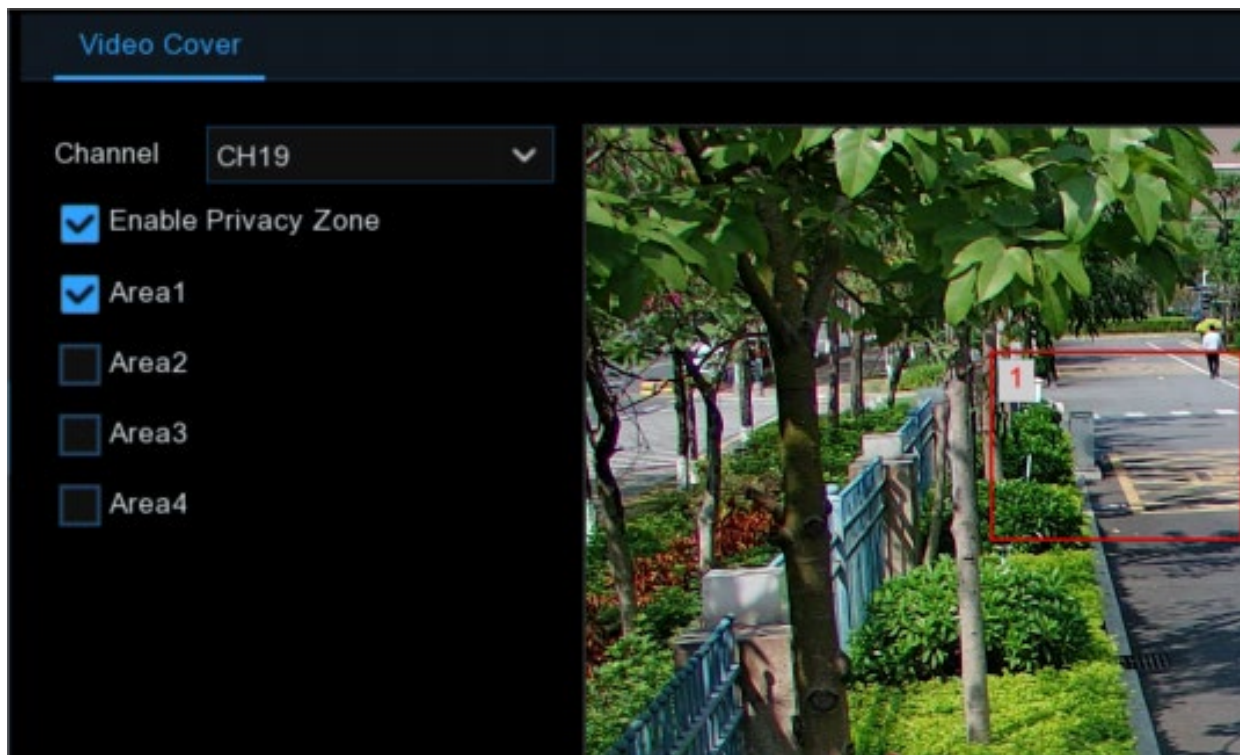

Channel: Select a camera that you would like to edit.

Enable Privacy Zone: Tick to enable this function.

Area: You can set up to four private areas in the screen, all 4 areas can be moved and stretched, click Apply to save and take effect.

Note: After setting the privacy area, the screen covered by the privacy area will not be visible in preview and playback.

5.1.6 Motion Detection

Users can configure the parameters related to motion detection on this page. When the camera detects a moving target in the frame, the NVR will trigger the motion detection alarm.

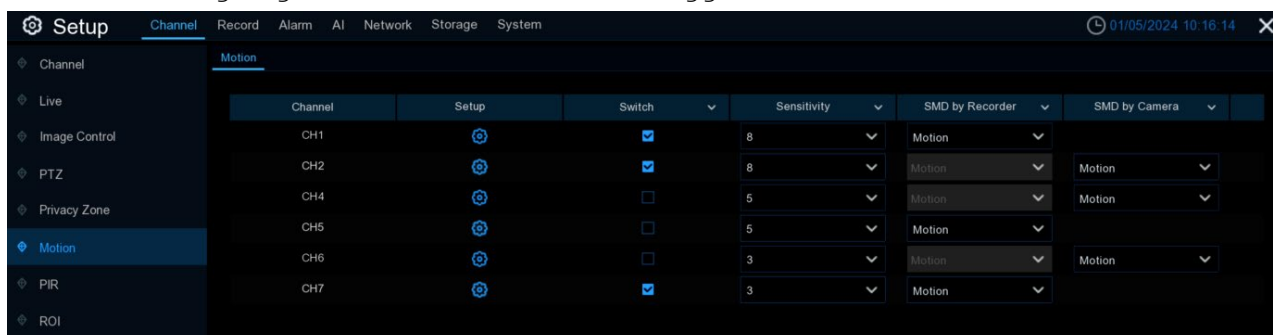

Switch: Enable or disable motion detection.

Sensitivity: Adjust the sensitivity level. Higher numbers make the NVR more sensitive to motion detection, but it may correspondingly increase false detection.

SMD by Recorder: For cameras that do not support smart motion detection. There are four detection types to choose from: Motion, Pedestrian, Vehicle, and Vehicle & Pedestrian.

SMD by Camera: For IP cameras that support intelligent motion detection. There are four detection types to choose from: Motion, Pedestrian, Vehicle, and Vehicle & Pedestrian.

- **Motion:** The camera will detect all motion events, including movements of human beings, vehicles, animals, trees, etc.

If your camera or NVR supports smart motion detection (SMD), you'll be able to choose below advanced motion detection targets:

- **Human:** The camera will only alert when human movements are detected.
- **Vehicle:** The camera will only alert when vehicle movements are detected.
- **Vehicle & Human:** The camera will only alert when movements of human beings and/or vehicles are detected.

Click the settings button  for each channel to configure the motion detection area for that channel.



The areas covered by red grids in the image represent the active motion detection zones. Conversely, areas without red grids are inactive. Motion detected within the red grid areas will trigger alerts. Click **Select All** to designate the entire camera view as the motion detection area. Click **Clear All** to remove all previously set motion detection areas.

To set the desired area, use the left mouse button to single-click or drag-select the region on the screen. Once you've finished setting the area, right-click to return to the previous page. Then, click **Apply** in the bottom right corner to save your changes.

If you need to configure motion detection-related alarms, please refer to section [5.3.1. "Motion Alarm."](#)

5.1.7 PIR

When you connect a PIR (passive infrared motion detector) camera, this menu enables you to configure its parameters. When a PIR alarm is detected by one or more cameras, your NVR will alert you to a potential threat. It accomplishes this by sending you an email alert with an attached image from the camera (if this option is enabled) and/or by sending push notifications via the mobile app.

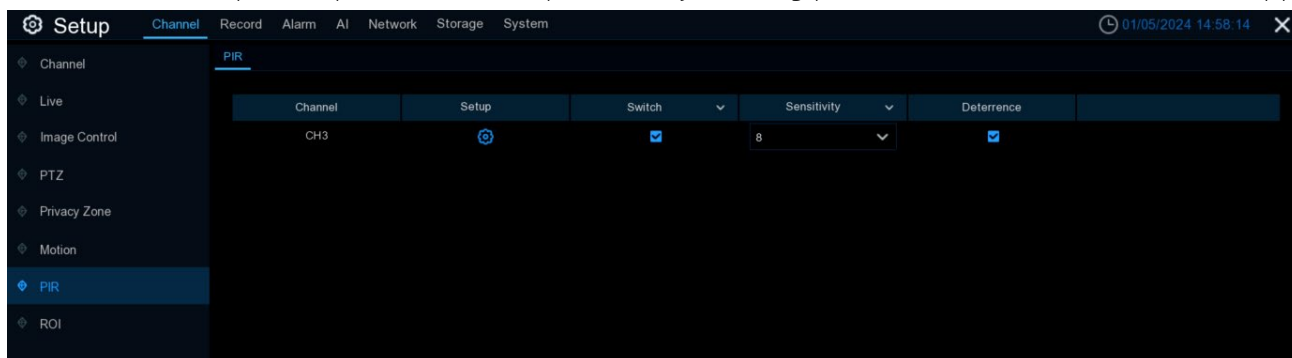

Switch: Enable or disable PIR detection.

Sensitivity: Adjust the sensitivity level. Higher numbers increase the NVR's sensitivity to PIR detection.

Deterrence: Toggle the linked white light alarm on or off. Note that for IP cameras of version 8.2.3 and later, this option is grayed out. Instead, you can activate the linked alarm switch through the schedule. Refer to section [5.3.9 "Deterrent"](#) for details.

Click the settings button for each channel to configure the PIR detection area for that channel.

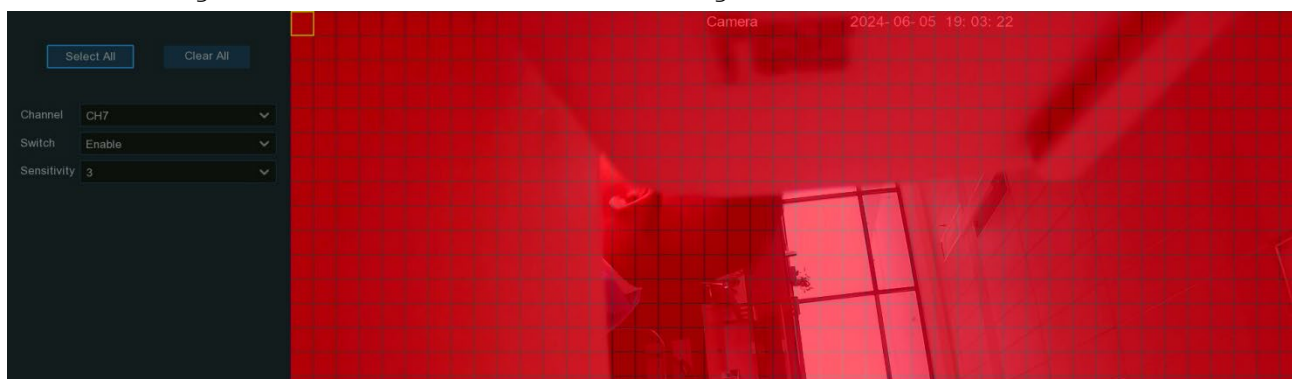

The areas covered by red grids in the image represent the active PIR detection zones. Conversely, areas without red grids are inactive. PIR detected within the red grid areas will trigger alerts. Click [Select All](#) to designate the entire camera view as the PIR detection area. Click [Clear All](#) to remove all previously set PIR detection areas.

To set the desired area, use the left mouse button to single-click or drag-select the region on the screen. Once you've finished setting the area, right-click to return to the previous page. Then, click [Apply](#) in the bottom right corner to save your changes.

5.1.8 ROI

This functionality is only applicable to supported cameras.

Regions of Interest (ROI) are specific areas in a video that receive focused attention. This feature enhances the image encoding quality within these selected regions and reduces the encoding quality outside them. The goal is to maintain sharpness in the important areas while keeping a constant overall bitrate. Please note that this function requires camera support and cannot be used with H.264+ or H.265+ encoding types simultaneously.

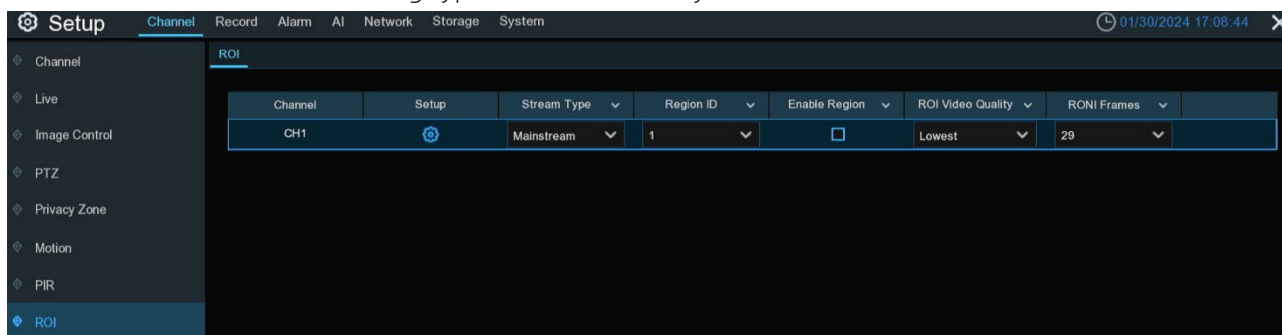

Stream Type: Select the type of stream you wish to set.

Region ID: Choose the region ID to configure. You can set up to eight region IDs.

ROI Video Quality: Set the image quality within the ROI; higher quality results in a clearer and smoother image.

RONI Frames: Set the frame rate for areas outside the ROI.

Click the settings button for each channel to configure the PIR detection area for that channel.

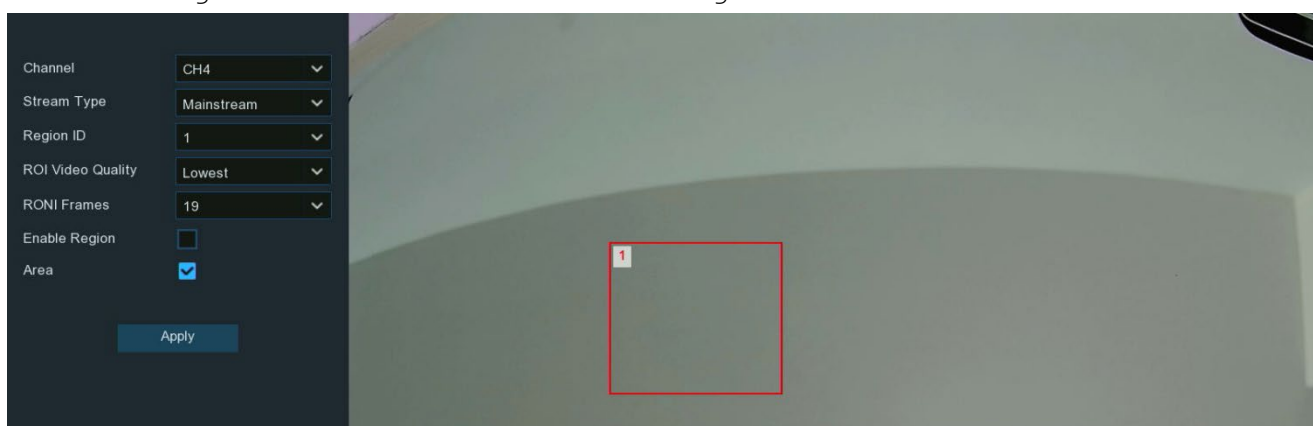

When you check the "Area" option, a red rectangular box will appear on the screen, representing the ROI (Region of Interest). You can click inside this red box and drag it to the desired area where you want the ROI to be active. Additionally, you can press and hold any side of the red box, then drag it to resize the box and adjust the size of the ROI.

5.2 Record

The recording configuration options are available in the Record and Capture menus accessible from the Main Menu. From here, you can access and change the recording frame rate & resolution and recording schedule for each connected camera. Additionally, you can enable and set a schedule for your NVR to take a snapshot each time an event occurs.

5.2.1 Encoding Settings

This menu allows you to configure the recording video or network transmission picture quality. Generally, the following streams are defined:

- **Mainstream:** Defines the recording video quality saved on the HDD.
- **Substream:** Defines the video quality viewed via remote access, such as web client & CMS/VMS.
- **Mobile Stream:** Defines the video quality viewed via remote access on mobile devices.

5.2.1.1 Video Encoding

You can configure the encoding parameters of the mainstream, substream, and mobile stream accordingly.

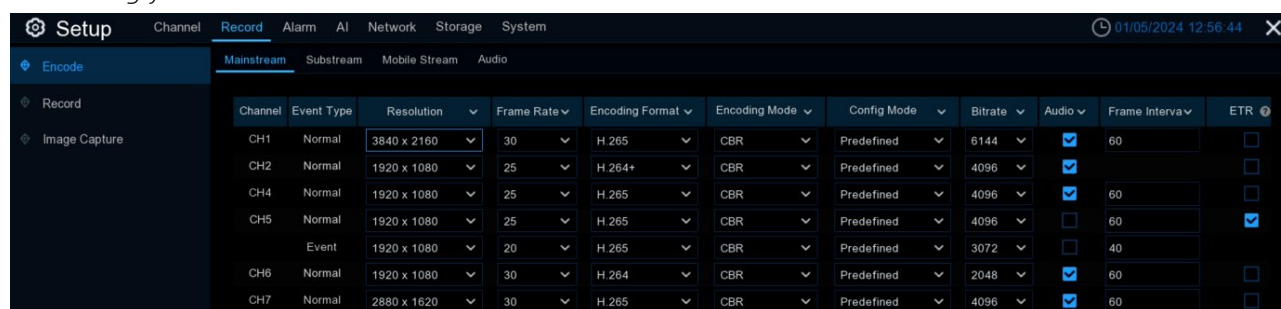

Channel	Event Type	Resolution	Frame Rate	Encoding Format	Encoding Mode	Config Mode	Bitrate	Audio	Frame Interval	ETR
CH1	Normal	3840 x 2160	30	H.265	CBR	Predefined	6144	<input checked="" type="checkbox"/>	60	<input type="checkbox"/>
CH2	Normal	1920 x 1080	25	H.264+	CBR	Predefined	4096	<input checked="" type="checkbox"/>		<input type="checkbox"/>
CH4	Normal	1920 x 1080	25	H.265	CBR	Predefined	4096	<input checked="" type="checkbox"/>	60	<input type="checkbox"/>
CH5	Normal	1920 x 1080	25	H.265	CBR	Predefined	4096	<input checked="" type="checkbox"/>	60	<input checked="" type="checkbox"/>
	Event	1920 x 1080	20	H.265	CBR	Predefined	3072	<input type="checkbox"/>	40	<input checked="" type="checkbox"/>
CH6	Normal	1920 x 1080	30	H.264	CBR	Predefined	2048	<input checked="" type="checkbox"/>	60	<input type="checkbox"/>
CH7	Normal	2880 x 1620	30	H.265	CBR	Predefined	4096	<input checked="" type="checkbox"/>	60	<input type="checkbox"/>

Resolution: Determines the size of recorded images. Higher values offer greater detail. The default resolution is auto-selected by your NVR.

Frame Rate: Specifies the number of frames recorded per second. The default frame rate is auto-selected by your NVR.

Encoding Format: Lists the supported codec for the connected camera. H.265 compresses information more efficiently for better video quality at a given bandwidth. H.265+ offers even greater compression. H.264 requires higher bandwidth and offers less efficient compression. H.264+ provides additional compression compared to H.264. Please note that only some devices support H.264+ and H.265+. Please note that in the substream, some cameras also support the MJPEG format. If you choose this encoding format, during preview, only one channel of MJPEG encoding will be displayed.

Encoding Mode: Choose between constant bitrate (CBR) for simpler scenes and variable bitrate (VBR) for more complex scenes.

Video Quality: Available only for VBR, this setting allows you to select the recording quality, which in turn defines the variable bitrate used.

Config Mode: Select either User-defined mode to manually set the bitrate or Predefined mode to choose from predefined bitrate.

Bitrate: Determines the speed of data transfer used for video recording. Higher bitrates result in better-quality recordings but require more bandwidth. Adjust incrementally until satisfied with image quality.

Audio: Enables or disables audio recording if your camera supports it. Make sure to enable Audio streaming in the Audio Encoding section if you want to record audio.

I Frame Interval: This parameter sets the interval between I frames (keyframes) in the IP camera's stream. I frames are full frames, while other frames are encoded based on the differences from preceding frames (P frames or B frames). A shorter interval can improve video quality but may increase bandwidth usage.

ETR: ETR (Event Trigger Recording) allows you to adjust codec stream parameters for recording based on whether an alarm is present or not. This optimization ensures that crucial events, such as motion detection or alarm activation, are captured with optimal quality and efficiency.

For cameras supporting ETR, you can set different video streaming settings for normal and alarm-triggered recording. After selecting ETR, an additional configuration option labeled "Event Type" with the option "Event" will appear below the information section for that channel. You can customize this setting according to your specific requirements.

Channel	Event Type	Resolution	Frame Rate	Encoding Format	Encoding Mode	Config Mode	Bitrate	Audio
CH1	Normal	2592 x 1944	30	H.265+	CBR	Predefined	4096	<input checked="" type="checkbox"/>
	Event	2592 x 1944	30	H.265	CBR	Predefined	4096	<input checked="" type="checkbox"/>

For example, during normal recording, you can lower the frame rate and bitrate to reduce file size, while increasing them during alarm events for clearer and smoother camera images.

It's crucial to note that ETR is applicable only to the mainstream stream.

5.2.1.2 Audio Encoding

If your camera includes a built-in microphone or an external audio input device, you can activate the audio stream. You can then adjust the input/output volume and select the audio encode type.

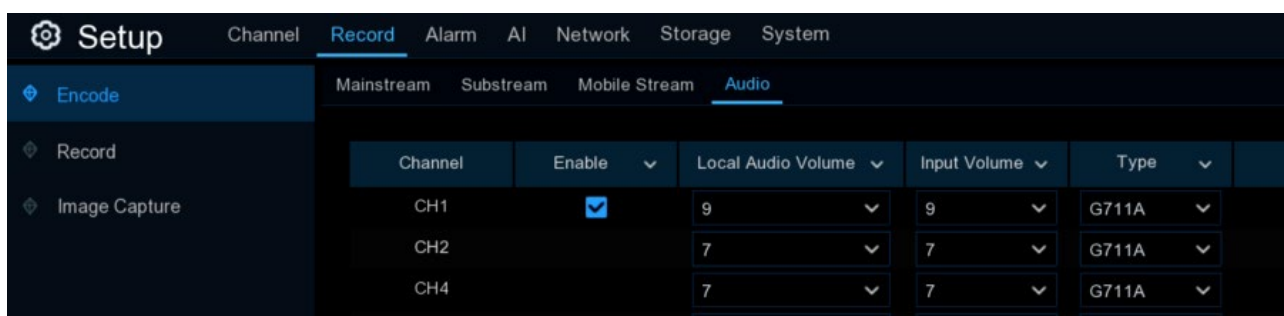

Enable: Toggle to turn on or off the audio streaming.

Local Audio Volume: This is to define the volume level of the audio output on the NVR locally.

Input Volume: Adjust the audio input volume.

Type: Choose the audio encoding codec.

5.2.2 Record

This menu enables you to set up the recording settings for every individual channel.

5.2.2.1 Recording Configuration

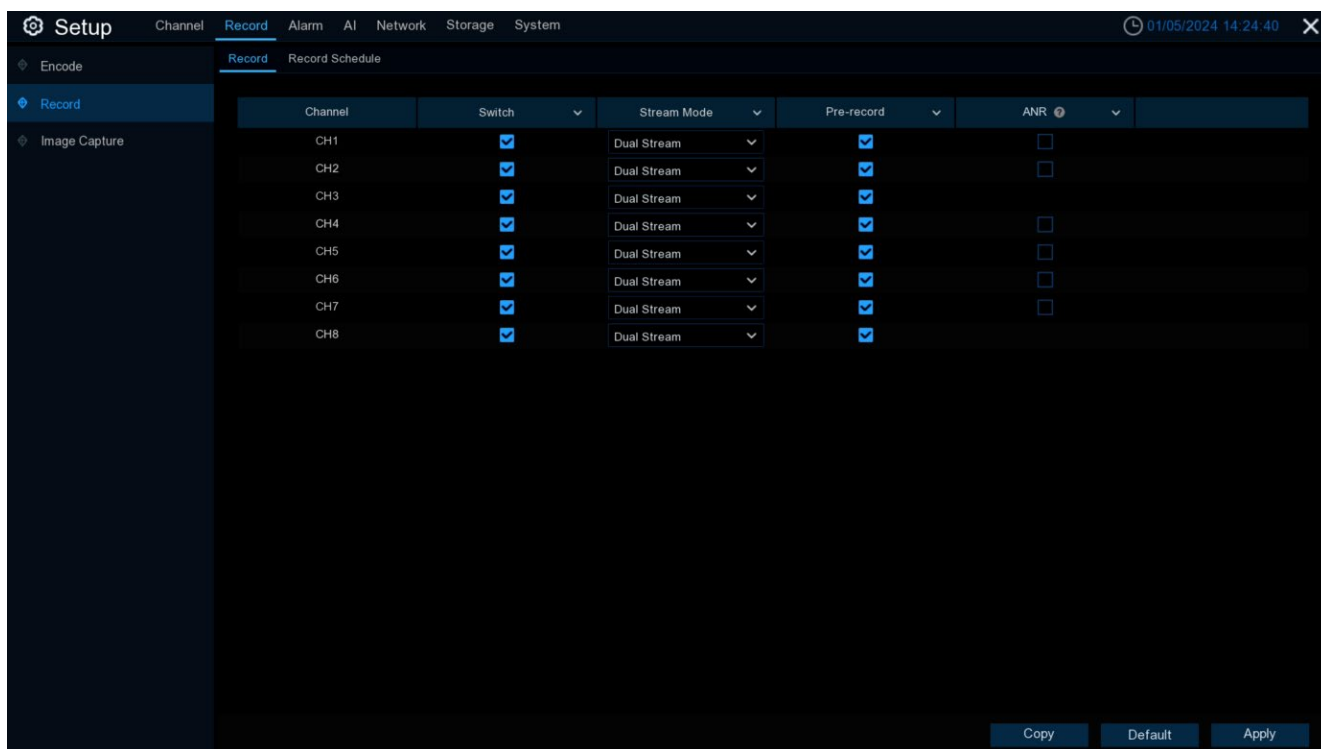

Switch: Check this to enable recording for this channel.

Stream Mode: By default, your NVR will record both the Mainstream (high quality) and substream (lower quality) video simultaneously (known as dual stream). The Mainstream video is used for playback when accessing the NVR directly, while the substream mainly is used for remote viewing on your mobile device. If you don't need remote viewing, you can select to record just the Mainstream to save storage space.

Prerecord: This allows your NVR to capture video for several seconds before an event occurs. It is recommended to keep this enabled.

ANR(Automatic Network Replenishment): Normally, videos are stored on the NVR when the network connection between the NVR and cameras is working. With the ANR (Automatic Network Replenishment) function enabled, the camera will start continuously recording to its SD card if the connection is lost. Once the network is restored, the recordings on the camera's SD card will be transferred back to the NVR's storage. It is recommended to enable ANR if your camera supports this feature.

5.2.2.2 Recording Schedule

This menu allows you to specify when the NVR records video and define the recording mode for each channel. The recording schedule enables you to set up a schedule on a daily and hourly basis for normal (continuous) recording, motion detection recording, I/O alarm recording, and PIR (passive infrared) recording (if supported by your camera).

By default, the NVR is configured to record continuously 24 hours a day, 7 days a week. The schedule can be modified to fit your requirements, and each camera can have its own unique schedule if needed. The schedule uses color coding to represent different event types.



1. Choose a Channel you want to set up the schedule for.
2. Click on the mode radio button to choose one of the recording modes:
 - **Normal:** Your NVR will record continuously for the scheduled period. The time slot will be marked in green for normal recording.
 - **Motion:** Your NVR will only record when motion is detected. The time slot will be marked in yellow for motion detection recording.
 - **IO:** Your NVR will only record when an external sensor is triggered. The time slot will be marked in red for sensor-triggered recording.
 - **PIR:** Your NVR will only record when PIR detection occurs. The time slot will be marked in purple for PIR detection recording.
3. Drag the cursor to mark the desired time slots.

4. The set recording schedule applies only to the selected channel. If you want to use the same schedule for other channels, use the [Copy](#) function.
5. If a time slot is marked in black, it means there will be no recording during that period.
6. Click [Apply](#) to save your settings.

5.2.3 Capture Images

You can enable and schedule your NVR to capture snapshots during normal recording periods or whenever an event is triggered. This functionality aids in rapidly identifying alarm incidents and the snapshots can additionally be used for creating time-lapse videos.

5.2.3.1 Capture Configuration

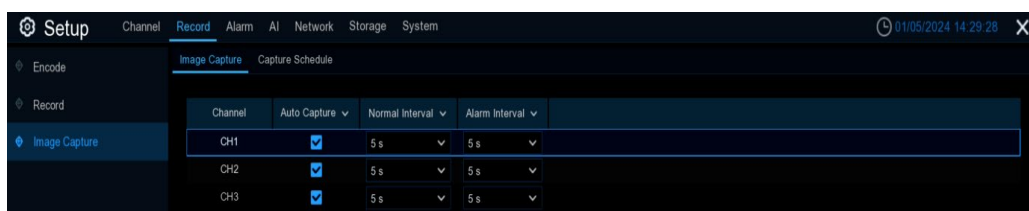

Auto Capture: Enable or disable snapshot capturing for this channel.

Normal Interval: The time interval between taking snapshots during regular recording periods.

Alarm Interval: The interval for capturing snapshots when events like motion detection, I/O alarm or PIR are triggered.

5.2.3.2 Capture Schedule

A capture schedule must be created to allow your NVR to take snapshots when an event occurs or at specified time intervals (e.g., every 5 seconds).

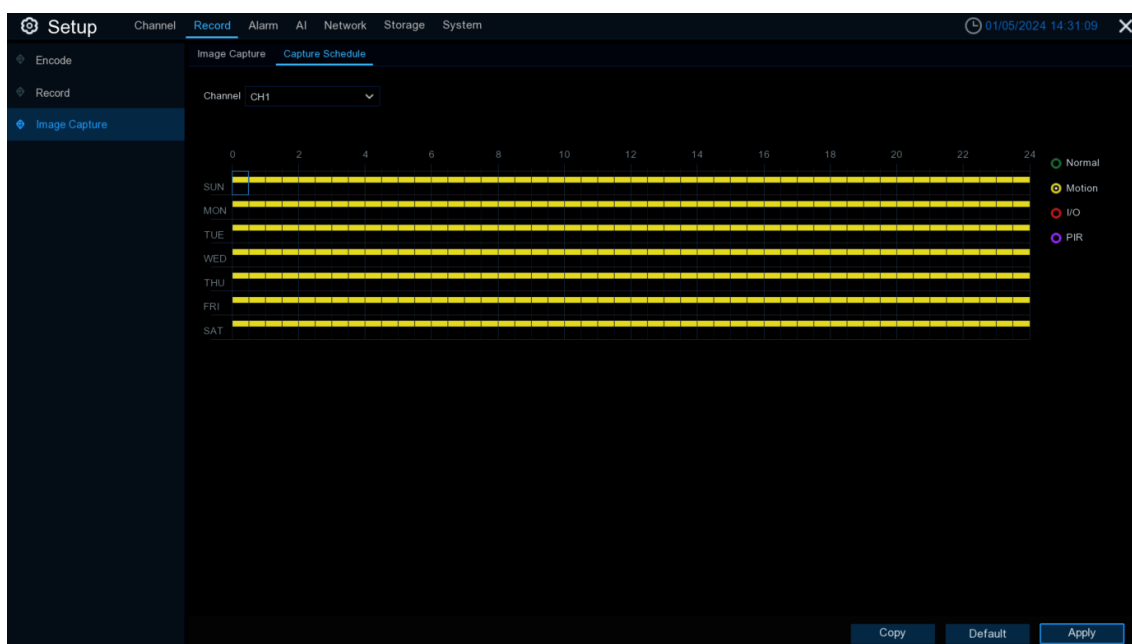

1. Choose the Channel you want to set up the snapshot schedule for
2. Click on the mode radio button to choose one of the capture modes:
 - **Normal:** Snapshots will be captured according to the set normal interval (e.g., every 5 seconds). Time slots will be marked in green for normal capture.
 - **Motion:** Snapshots will be captured during motion detection events. Time slots will be marked in yellow for motion detection capture.
 - **IO:** Snapshots will be captured when an external sensor is triggered. Time slots will be marked in red for I/O triggered capture.
 - **PIR:** Snapshots will be captured when PIR (passive infrared) detection occurs. Time slots will be marked in purple for PIR capture.
3. Drag the cursor to mark the desired time slots on the schedule.
4. The set capture schedule applies only to the selected channel. If you want to use the same schedule for other channels, use the **Copy** function.
5. Black time slots indicate that no snapshots will be captured during those periods.
6. Click **Apply** to save your settings.

5.3 Alarm Settings

In this section, you can configure the alarm actions when event occurs.

5.3.1 Motion Alarm

This menu allows you to configure the parameters related to motion alarms.

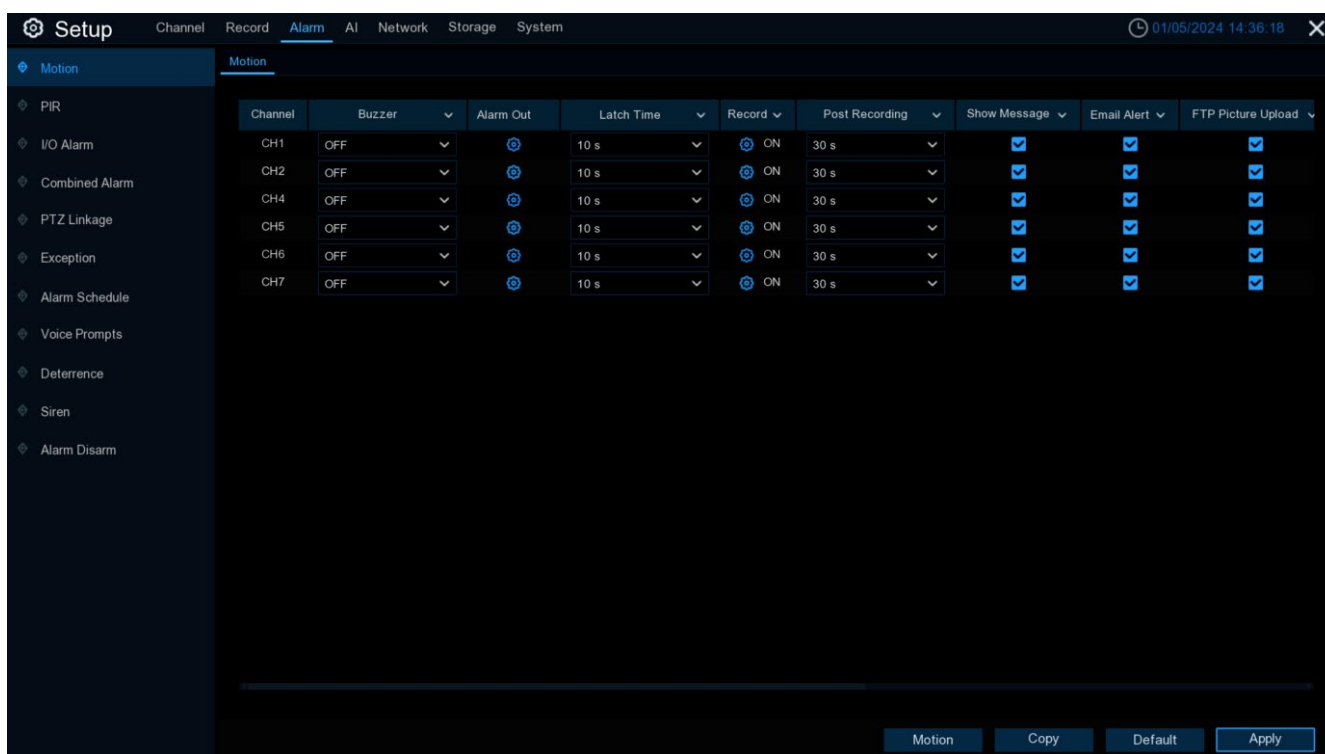

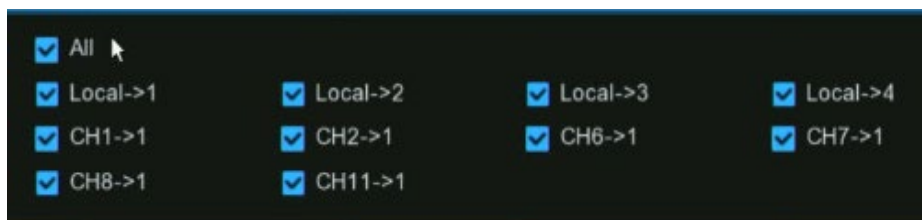

Buzzer: When a detection event is triggered, you can enable the NVR's buzzer to provide an audible alert for a preset duration. Click the drop-down menu to select the desired time.

Alarm Out: If your NVR or IP camera supports connecting external alarm output devices, the system can send an alert notification to these devices. Click  button to choose the external alarm devices:



- **Local->x:** External alarm devices connected directly to the NVR.
- **CHx->1:** External alarm devices connected to the IP cameras.

Latch Time: Configure the duration for which external alarms will be activated when a detection event triggers.

Record: This option instructs your NVR to trigger recording on additional cameras when a detection event triggers. Click the drop-down arrow  to choose whether to record on all channels or not. Click  button, then click the "Record Channel" checkbox to enable recording. Click the checkbox in front of the channel number to select all channels for recording, or click on individual camera numbers to select them for triggered recording.

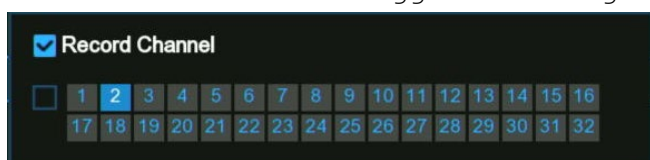

Post Recording: This option sets your NVR to continue recording for a specified time after an event has occurred. The default selection is suitable for most cases, but you can modify it if needed.

Show Message: When a detection event triggers, the alarm icon  will appear on the screen.

Email Alert: An email alert will be sent when a detection event triggers. Tick the checkbox if you want to disable this.

Email Alert	FTP Picture Upload	FTP Video Upload	Picture to Cloud	Video to Cloud	Full Screen	Event Push Platform	Voice Prompts
<input checked="" type="checkbox"/>	<input checked="" type="checkbox"/>	<input type="checkbox"/>	<input checked="" type="checkbox"/>	<input type="checkbox"/>	<input type="checkbox"/>	<input type="checkbox"/>	
<input checked="" type="checkbox"/>	<input checked="" type="checkbox"/>	<input type="checkbox"/>	<input checked="" type="checkbox"/>	<input type="checkbox"/>	<input type="checkbox"/>	<input type="checkbox"/>	
<input checked="" type="checkbox"/>	<input checked="" type="checkbox"/>	<input type="checkbox"/>	<input checked="" type="checkbox"/>	<input type="checkbox"/>	<input type="checkbox"/>	<input type="checkbox"/>	
<input checked="" type="checkbox"/>	<input checked="" type="checkbox"/>	<input type="checkbox"/>	<input checked="" type="checkbox"/>	<input type="checkbox"/>	<input type="checkbox"/>	<input type="checkbox"/>	

(Slide to the right to view more options)

FTP Picture Upload: Check this box to upload snapshots to your FTP server when a detection event triggers.

FTP Video Upload: Check this box to upload video clips to your FTP server when a detection event triggers.

Picture to Cloud: Check this box to upload snapshots to your cloud storage (Dropbox or Google Drive) when a detection event triggers.

Video to Cloud: Check this box to upload video clips to your cloud storage (Dropbox or Google Drive) when a detection event triggers. Due to system limitations, regardless of the alarm type, a maximum of two channels' videos can be selected for uploading in total for all alarm types.

Full Screen: Check this box to display the triggered camera feed in full-screen Live View mode when a detection event triggers.

Event Push Platform: Check this option to push notifications of this alarm event type to the client software/app when triggered. See section [5.5.6 Platform Access](#) for settings of push platform.

Voice Prompts: If your NVR is connected to a speaker, you can select a customized voice alert to play when a detection event triggers. See section [5.3.8 Voice Prompts](#) for adding custom voice alerts.

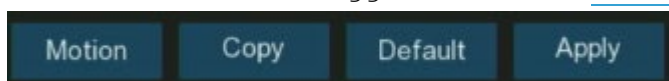

Motion: Configure the motion detection settings. See section [5.1.6 Motion Detection](#) for more details.

Default: Click "Default" to revert all settings to their default values.

Copy: Use the "Copy" function to apply the current settings to other connected cameras.

Apply: Click "Apply" to save settings.

5.3.2 PIR Alarm

This menu allows you to configure the parameters related to PIR alarms.

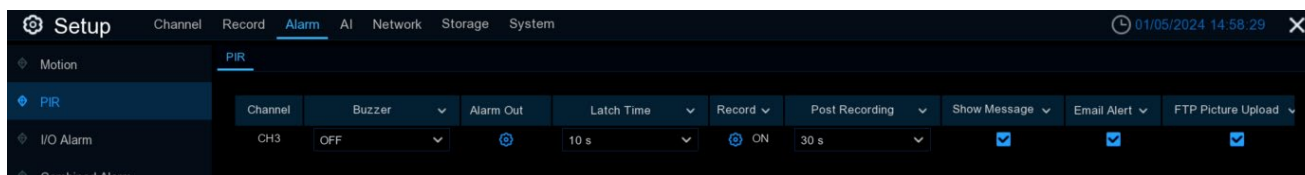

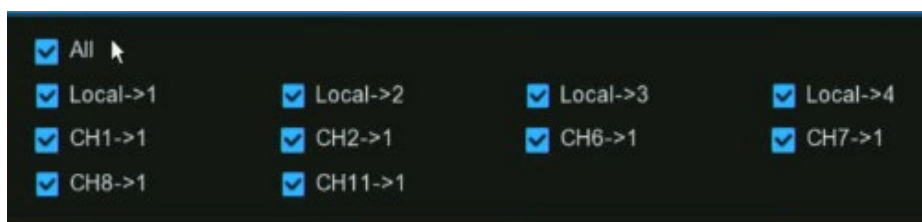

Buzzer: When a detection event is triggered, you can enable the NVR's buzzer to provide an audible alert for a preset duration. Click the drop-down menu to select the desired time.

Alarm Out: If your NVR or IP camera supports connecting external alarm output devices, the system can send an alert notification to these devices. Click  button to choose the external alarm devices:



- **Local->x:** External alarm devices connected directly to the NVR.
- **CHx->1:** External alarm devices connected to the IP cameras.

Latch Time: Configure the duration for which external alarms will be activated when a detection event triggers.

Record: This option instructs your NVR to trigger recording on additional cameras when a detection event triggers. Click the drop-down arrow  to choose whether to record on all channels or not. Click  button, then click the "Record Channel" checkbox. Click the checkbox in front of the channel number to select all channels for recording, or click on individual camera numbers to select them for triggered recording.

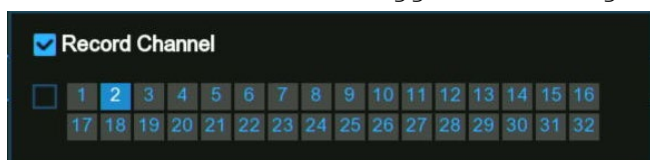

Post Recording: This option sets your NVR to continue recording for a specified time after an event has occurred. The default selection is suitable for most cases, but you can modify it if needed.

Show Message: When a detection event triggers, the alarm icon  will appear on the screen.

Email Alert: An email alert will be sent when a detection event triggers. Tick the checkbox if you want to disable this.

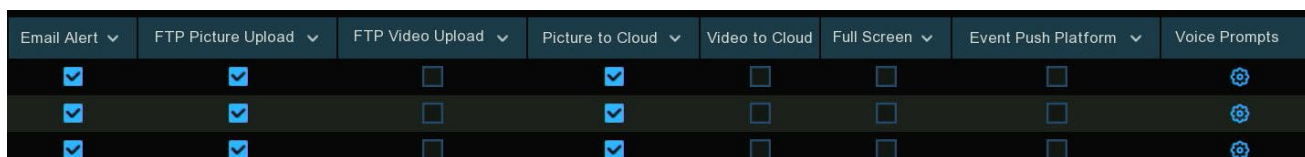

(Slide to the right to view more options)

FTP Picture Upload: Check this box to upload snapshots to your FTP server when a detection event triggers.

FTP Video Upload: Check this box to upload video clips to your FTP server when a detection event triggers.

Picture to Cloud: Check this box to upload snapshots to your cloud storage (Dropbox or Google Drive) when a detection event triggers.

Video to Cloud: Check this box to upload video clips to your cloud storage (Dropbox or Google Drive) when a detection event triggers. Due to system limitations, regardless of the alarm type, a maximum of two channels' videos can be selected for uploading in total for all alarm types.

Full Screen: Check this box to display the triggered camera feed in full-screen Live View mode when a detection event triggers.

Event Push Platform: Check this option to push notifications of this alarm event type to the client software/app when triggered. See session [5.5.6 platform Access](#) for settings of push platform.

Voice Prompts: If your NVR is connected to a speaker, you can select a customized voice alert to play when a detection event triggers. See section [5.3.8 Voice Prompts](#) for adding custom voice alerts.

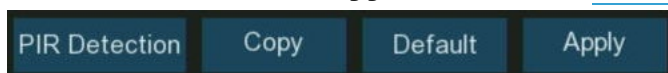

PIR Detection: Configure the PIR detection settings. See section [5.1.7 PIR](#) for more details.

Default: Click "Default" to revert all settings to their default values.

Copy: Use the "Copy" function to apply the current settings to other connected cameras.

Apply: Click "Apply" to save settings.

5.3.3 I/O Alarm

If your NVR or the connected cameras have alarm input functionality, you will need to configure the settings appropriately to ensure the connected sensors operate properly.

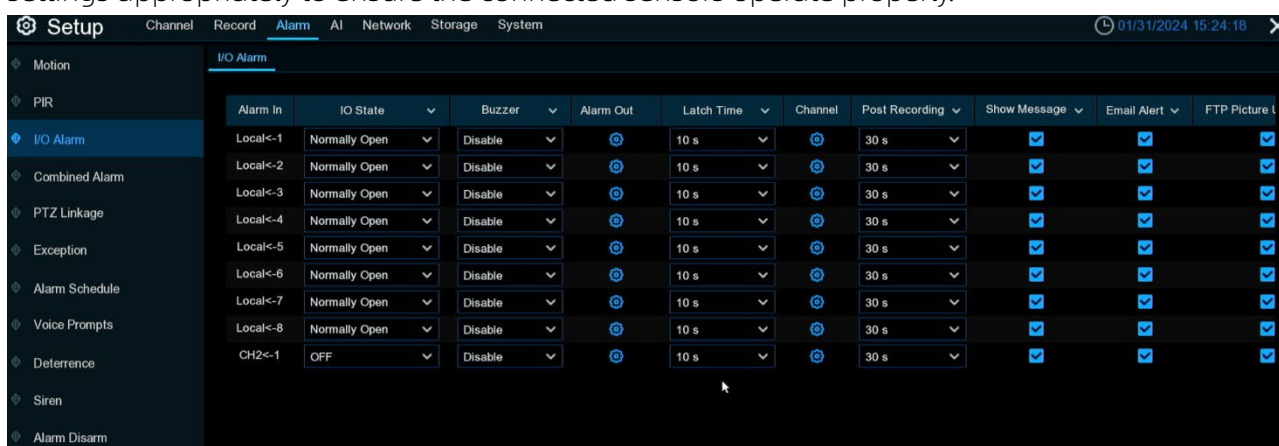

Alarm In: Alarm input channel

- **Local<-x:** Alarm input devices connected directly to the NVR.
- **CHx<-1:** Alarm input devices connected to the IP cameras.

IO State: There are 3 types to choose from: Normally Open, Normally Close, and OFF. Select the one that matches your sensor's configuration, or choose OFF to disable the sensor trigger function.



Buzzer: When a detection event is triggered, you can enable the NVR's buzzer to provide an audible alert for a preset duration. Click the drop-down menu to select the desired time.

Alarm Out: If your NVR or IP camera supports connecting external alarm output devices, the system can send an alert notification to these devices. Click  button to choose the external alarm devices:



- **Local->x:** External alarm devices connected directly to the NVR.
- **CHx->1:** External alarm devices connected to the IP cameras.

Latch Time: Configure the duration for which external alarms will be activated when a detection event triggers.



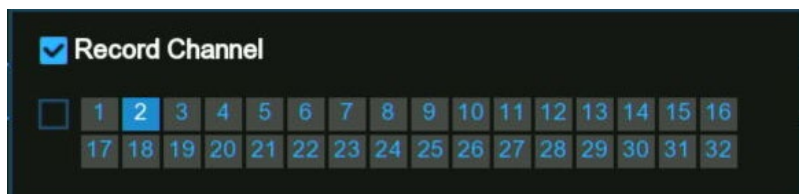

Channel: This option instructs your NVR to trigger recording on additional cameras when a detection event triggers. Click the drop-down arrow  to choose whether to record on all channels or not. Click  button, then click the "Record Channel" checkbox to enable recording. Click the checkbox in front of the channel number to select all channels for recording, or click on individual camera numbers to select them for triggered recording.



Post Recording: This option sets your NVR to continue recording for a specified time after an event has occurred. The default selection is suitable for most cases, but you can modify it if needed.

Show Message: When a detection event triggers, the alarm icon  will appear on the screen.

Email Alert: An email alert will be sent when a detection event triggers. Tick the checkbox if you want to disable this.

Email Alert	FTP Picture Upload	FTP Video Upload	Picture to Cloud	Video to Cloud	Full Screen	Event Push Platform	Voice Prompts
<input checked="" type="checkbox"/>	<input checked="" type="checkbox"/>	<input type="checkbox"/>	<input checked="" type="checkbox"/>	<input type="checkbox"/>	<input type="checkbox"/>	<input type="checkbox"/>	
<input checked="" type="checkbox"/>	<input checked="" type="checkbox"/>	<input type="checkbox"/>	<input checked="" type="checkbox"/>	<input type="checkbox"/>	<input type="checkbox"/>	<input type="checkbox"/>	
<input checked="" type="checkbox"/>	<input checked="" type="checkbox"/>	<input type="checkbox"/>	<input checked="" type="checkbox"/>	<input type="checkbox"/>	<input type="checkbox"/>	<input type="checkbox"/>	
<input checked="" type="checkbox"/>	<input checked="" type="checkbox"/>	<input type="checkbox"/>	<input checked="" type="checkbox"/>	<input type="checkbox"/>	<input type="checkbox"/>	<input type="checkbox"/>	

(Slide to the right to view more options)

FTP Picture Upload: Check this box to upload snapshots to your FTP server when a detection event triggers.

FTP Video Upload: Check this box to upload video clips to your FTP server when a detection event triggers.

Picture to Cloud: Check this box to upload snapshots to your cloud storage (Dropbox or Google Drive) when a detection event triggers.

Video to Cloud: Check this box to upload video clips to your cloud storage (Dropbox or Google Drive) when a detection event triggers. Due to system limitations, regardless of the alarm type, a maximum of two channels' videos can be selected for uploading in total for all alarm types.

Full Screen: Check this box to display the triggered camera feed in full-screen Live View mode when a detection event triggers.

Voice Prompts: If your NVR is connected to a speaker, you can select a customized voice alert to play when a detection event triggers. See section [5.3.8 Voice Prompts](#) for adding custom voice alerts.

Default: Click "Default" to revert all settings to their default values.

Copy: Use the "Copy" function to apply the current settings to other connected cameras.

Apply: Click "Apply" to save settings.

5.3.4 Combined Alarm

The Combined Alarm function allows you to set a combination of two alarm types. The NVR will only trigger an alert when both specified alarm types in the combination occur simultaneously. This helps minimize false alarms.

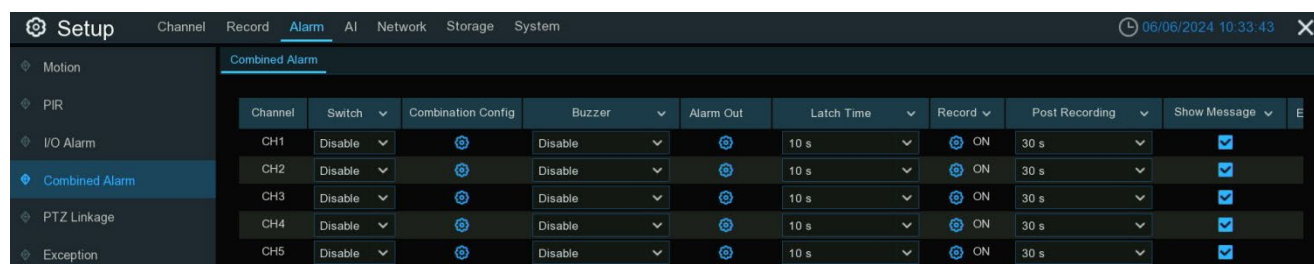

Channel	Switch	Combination Config	Buzzer	Alarm Out	Latch Time	Record	Post Recording	Show Message
CH1	Disable		Disable		10 s	ON	30 s	<input checked="" type="checkbox"/>
CH2	Disable		Disable		10 s	ON	30 s	<input checked="" type="checkbox"/>
CH3	Disable		Disable		10 s	ON	30 s	<input checked="" type="checkbox"/>
CH4	Disable		Disable		10 s	ON	30 s	<input checked="" type="checkbox"/>
CH5	Disable		Disable		10 s	ON	30 s	<input checked="" type="checkbox"/>

Switch: Enable or disable the combined alarm function.

Combination Config: Click the Configuration button on a channel to choose the alarm combination. You can select 2 types of alarms from the drop-down list under Alarm Type, from either the NVR or the IP camera

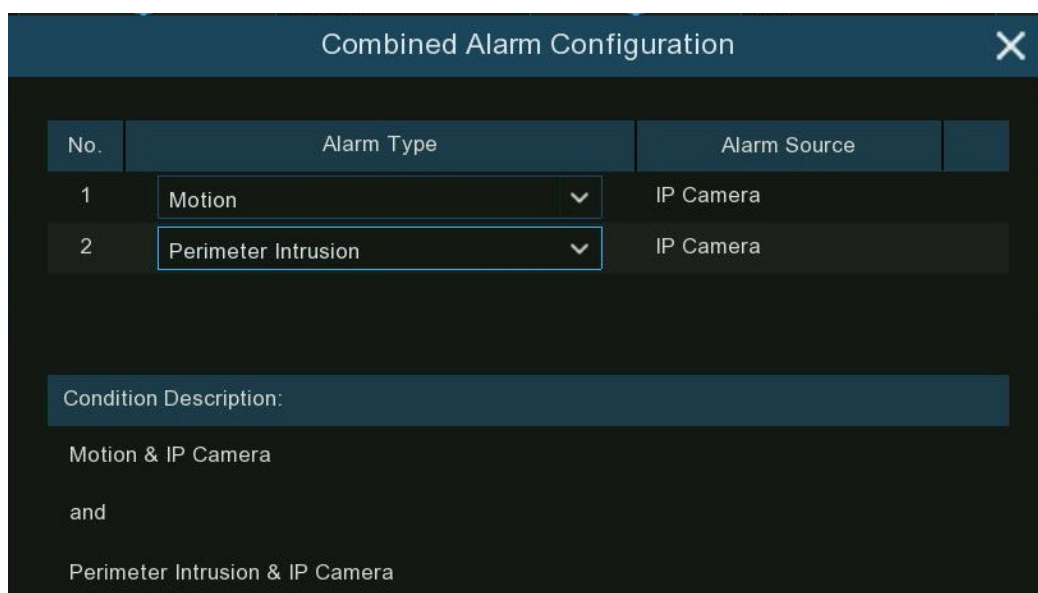



Buzzer: When a detection event is triggered, you can enable the NVR's buzzer to provide an audible alert for a preset duration. Click the drop-down menu to select the desired time.

Alarm Out: If your NVR or IP camera supports connecting external alarm output devices, the system can send an alert notification to these devices. Click  button to choose the external alarm devices:



- **Local->x:** External alarm devices connected directly to the NVR.
- **CHx->1:** External alarm devices connected to the IP cameras.

Latch Time: Configure the duration for which external alarms will be activated when a detection event triggers.

Channel: This option instructs your NVR to trigger recording on additional cameras when a detection event triggers. Click the drop-down arrow  to choose whether to record on all channels or not. Click  button, then click the "Record Channel" checkbox to enable recording. Click the checkbox in front of the channel number to select all channels for recording, or click on individual camera numbers to select them for triggered recording.

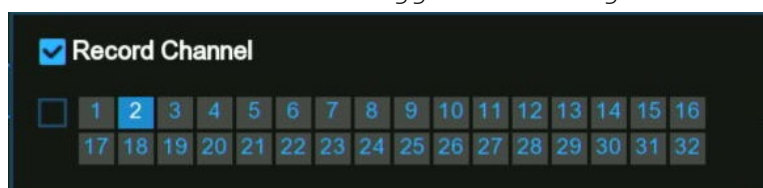

Post Recording: This option sets your NVR to continue recording for a specified time after an event has occurred. The default selection is suitable for most cases, but you can modify it if needed.

Show Message: When a detection event triggers, the alarm icon  will appear on the screen.

Email Alert: An email alert will be sent when a detection event triggers. Tick the checkbox if you want to disable this.

Email Alert	FTP Picture Upload	FTP Video Upload	Picture to Cloud	Video to Cloud	Full Screen	Event Push Platform	Voice Prompts
<input checked="" type="checkbox"/>	<input checked="" type="checkbox"/>	<input type="checkbox"/>	<input checked="" type="checkbox"/>	<input type="checkbox"/>	<input type="checkbox"/>	<input type="checkbox"/>	
<input checked="" type="checkbox"/>	<input checked="" type="checkbox"/>	<input type="checkbox"/>	<input checked="" type="checkbox"/>	<input type="checkbox"/>	<input type="checkbox"/>	<input type="checkbox"/>	
<input checked="" type="checkbox"/>	<input checked="" type="checkbox"/>	<input type="checkbox"/>	<input checked="" type="checkbox"/>	<input type="checkbox"/>	<input type="checkbox"/>	<input type="checkbox"/>	
<input checked="" type="checkbox"/>	<input checked="" type="checkbox"/>	<input type="checkbox"/>	<input checked="" type="checkbox"/>	<input type="checkbox"/>	<input type="checkbox"/>	<input type="checkbox"/>	

(Slide to the right to view more options)

FTP Picture Upload: Check this box to upload snapshots to your FTP server when a detection event triggers.

FTP Video Upload: Check this box to upload video clips to your FTP server when a detection event triggers.

Picture to Cloud: Check this box to upload snapshots to your cloud storage (Dropbox or Google Drive) when a detection event triggers.

Video to Cloud: Check this box to upload video clips to your cloud storage (Dropbox or Google Drive) when a detection event triggers. Due to system limitations, regardless of the alarm type, a maximum of two channels' videos can be selected for uploading in total for all alarm types.

Full Screen: Check this box to display the triggered camera feed in full-screen Live View mode when a detection event triggers.

Voice Prompts: If your NVR is connected to a speaker, you can select a customized voice alert to play when a detection event triggers. See section [5.3.8 Voice Prompts](#) for adding custom voice alerts.

Default: Click "Default" to revert all settings to their default values.

Copy: Use the "Copy" function to apply the current settings to other connected cameras.

Apply: Click "Apply" to save settings.

5.3.5 PTZ Linkage

If one or more PTZ cameras are connected to your NVR, you can configure their actions for specific alarm types. When an alarm occurs on a configured channel, the PTZ camera will quickly move to the preset position you have set in advance.

Channel	Switch	Alarm	PTZ1	PTZ2	PTZ3	PTZ4
CH1	<input checked="" type="checkbox"/>		ON	OFF	OFF	OFF
CH2	<input checked="" type="checkbox"/>		ON	OFF	OFF	OFF
CH3	<input checked="" type="checkbox"/>		ON	OFF	OFF	OFF
CH4	<input checked="" type="checkbox"/>		ON	OFF	OFF	OFF

Switch: Check the box to activate the PTZ linkage function.

Alarm: Click the setting button  and select the alarm type(s) to be associated with PTZ linkage from the pop-up menu.

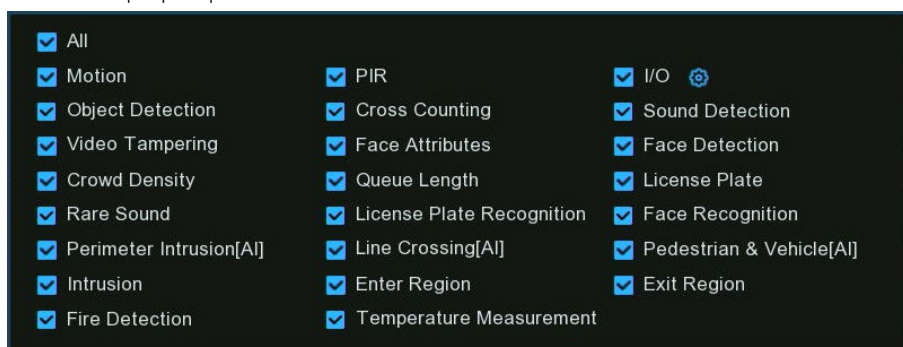

PTZ1 ~4: Each channel can be linked with up to 4 PTZ cameras. Click the setting button  below each PTZ option to select the corresponding PTZ camera channel and preset point.

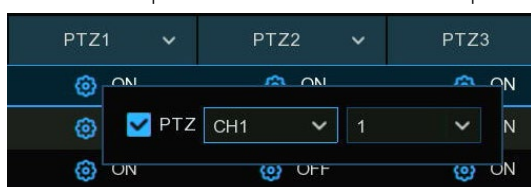









Copy: Use the "Copy" function to apply the current settings to other connected cameras.

Apply: Click "Apply" to save settings.

5.3.6 Exception Alarm

The system allows you to set the abnormal events that you want the NVR to notify you about.

Exception							
Event Type	Switch	Buzzer	Alarm Out	Latch Time	Show Message	Send Email	Voice Prompts
No Space on Disk	<input checked="" type="checkbox"/>	OFF		10 s	<input checked="" type="checkbox"/>	<input checked="" type="checkbox"/>	
Disk Error	<input checked="" type="checkbox"/>	OFF		10 s	<input checked="" type="checkbox"/>	<input checked="" type="checkbox"/>	
Video Loss	<input checked="" type="checkbox"/>	OFF		10 s	<input checked="" type="checkbox"/>	<input checked="" type="checkbox"/>	
Fan Abnormal	<input checked="" type="checkbox"/>	1 Min		10 s	<input checked="" type="checkbox"/>	<input checked="" type="checkbox"/>	

Event Type: There are 4 event types that your NVR will detect as exceptions:

- **No Space on Disk:** When the hard drive is full
- **Disk Error:** When the hard drive is not detected or ready
- **Video Loss:** When a camera is not properly connected.
- **Fan Abnoemal:** When there is a fan malfunction, such as low speed or stoppage. (Supported by certain models)

Switch: Enable or disable the exception alarm.

Buzzer: When a detection event is triggered, you can enable the NVR's buzzer to provide an audible alert for a preset duration. Click the drop-down menu to select the desired time.

Alarm Out: If your NVR or IP camera supports connecting external alarm output devices, the system can send an alert notification to these devices. Click  button to choose the external alarm devices:

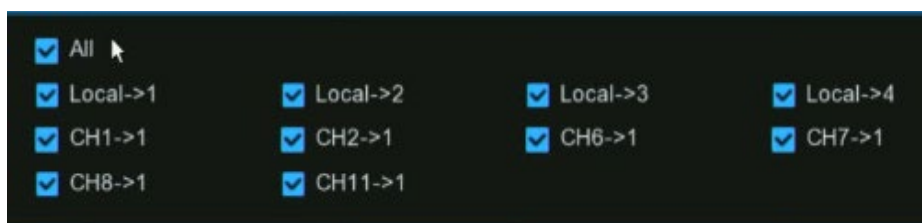

- **Local->x:** External alarm devices connected directly to the NVR.
- **CHx->1:** External alarm devices connected to the IP cameras.

Latch Time: Configure the duration for which external alarms will be activated when a detection event triggers.

Show Message: When a detection event triggers, an alarm message will appear on the screen.

Email Alert: An email alert will be sent when a detection event triggers. Tick the checkbox if you want to disable this.

Voice Prompts: If your NVR is connected to a speaker, you can select a customized voice alert to play when a detection event triggers. See section [5.3.8 Voice Prompts](#) for adding custom voice alerts.

Default: Click "**Default**" to revert all settings to their default values.

Copy: Use the "**Copy**" function to apply the current settings to other connected cameras.

Apply: Click "**Apply**" to save settings.

5.3.7 Alarm Schedule

You can set the schedule individually for Alarm Out, Mobile Push Notification, FTP Upload, Cloud Upload, Buzzer, and Voice Prompts. By default, the schedule is enabled 24/7, but you can adjust it as needed.

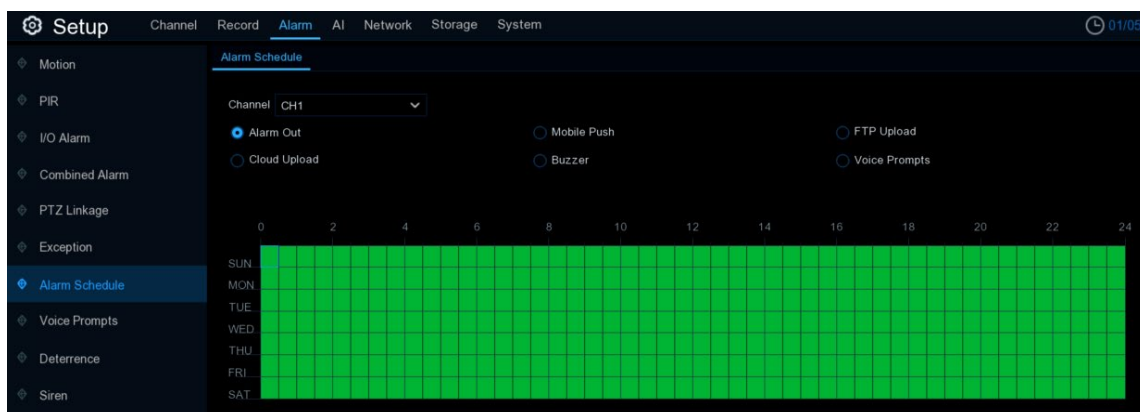

1. Select the channel you want to set the schedule for.
2. Click on the radio button of the event you want to set.
3. Drag the cursor to mark the slots. The green blocks in the time slots will indicate active alarm periods.
4. The schedule is valid only for the selected channel each time when you set. If you want to use the same schedule for other channels, use [Copy](#) function.
5. Click [Save](#) to save your settings.

5.3.8 Voice Prompts

If your NVR or IP camera supports the voice prompt function and has a built-in or external speaker, you can set a customized alert voice for when an alarm event occurs. When an alarm is triggered, the system will receive the alarm signal and activate the voice broadcasting equipment to automatically or manually play the associated audio message on-site, such as announcing "invasion" behavior.

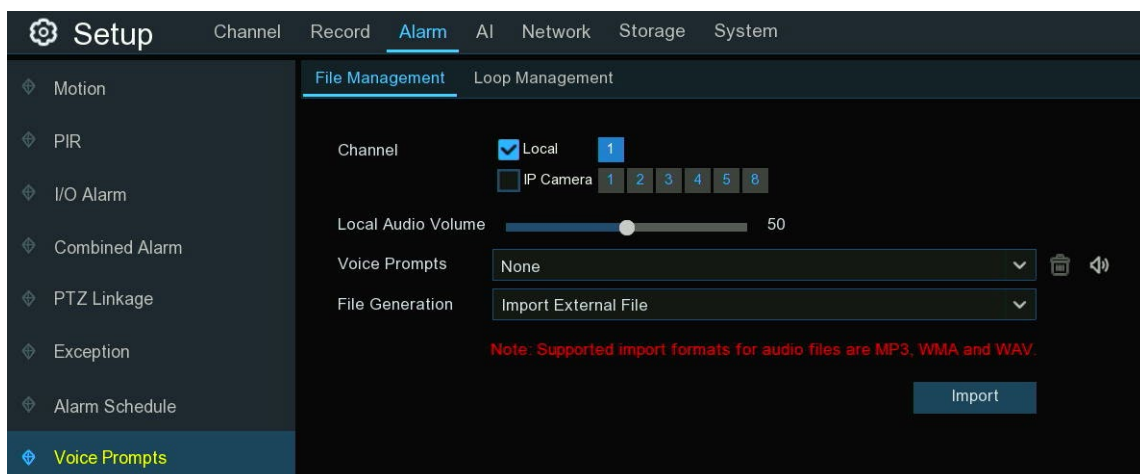

5.3.8.1. Voice File Management

You can create and delete voice files in this section.

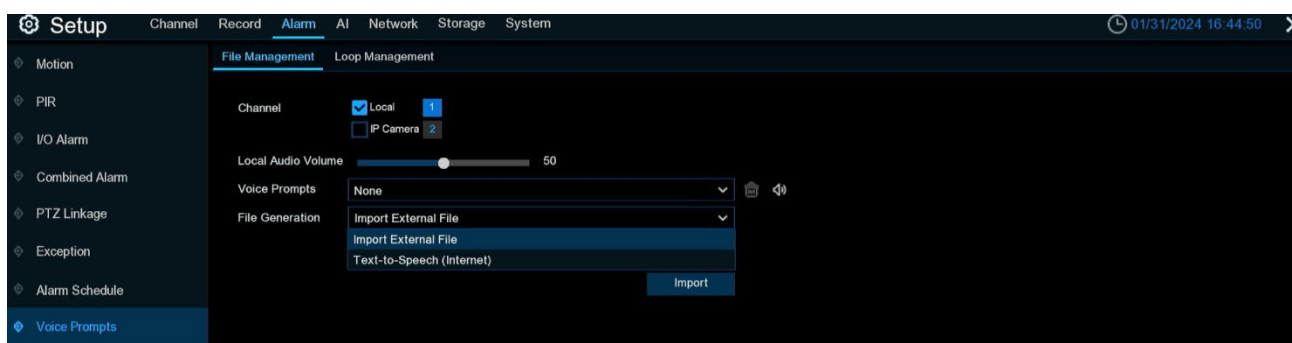

5.3.8.1.1 Creating & Deleting Voice File

The system provides 2 different methods to create customized voices: [Import External Files](#) and [Text-to-Speech](#):

- **Import External Files:** Supports importing MP3, WMA, and WAV files from a USB flash drive and/or web page. The allowed file size is less than 5MB.
 1. Copy the pre-prepared audio files to a USB flash drive, then insert the USB drive into the NVR.

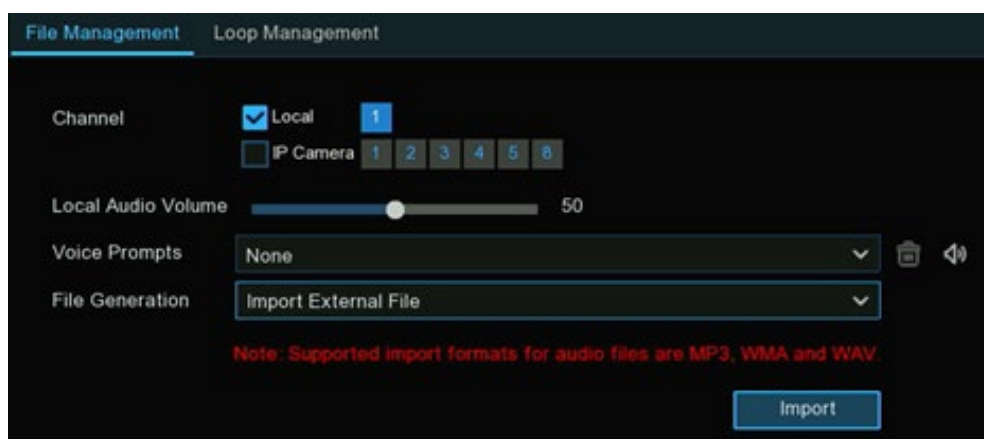

2. Choose the [Import External Files](#) model, then click the [Import](#) button and choose the audio file from your USB memory. Only one file can be added at a time. Multiple files can be added at once from the web page.

- **Text-to-Speech:** The system supports converting your plain text into a multi-language audio file using an internet server.

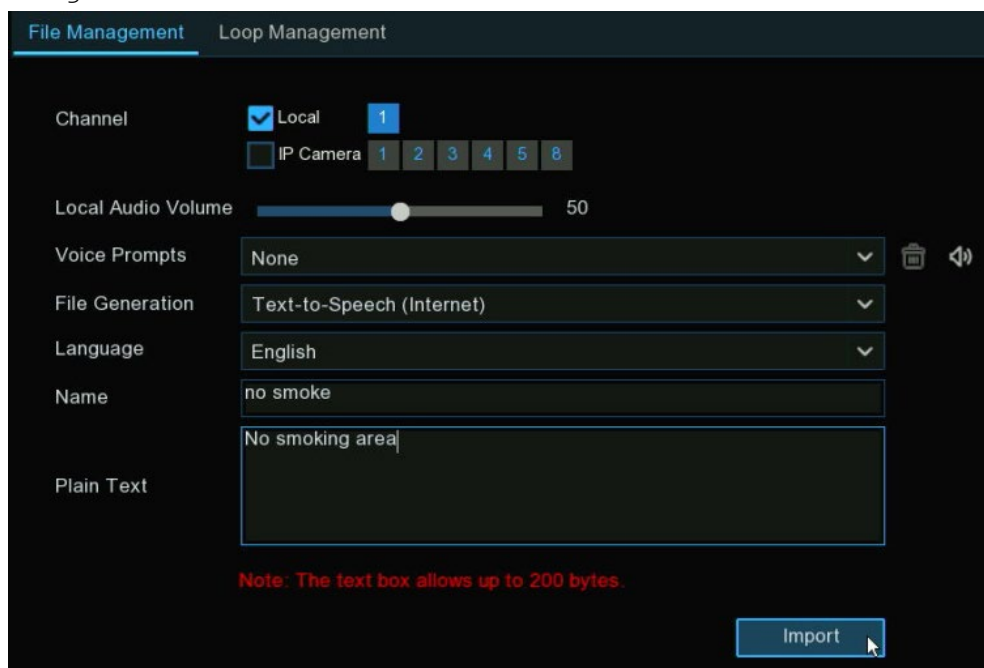

1. Choose the **Text-to-Speech** mode and the language you want
2. Input the file name and plain text. The maximum length for the input text is 200 bytes.
3. Click the **Import** button; the system will convert the text you input into a voice file and save it to the NVR storage.

It is recommended to use the web page for multi-language input.

To delete voice file(s), please follow these steps:

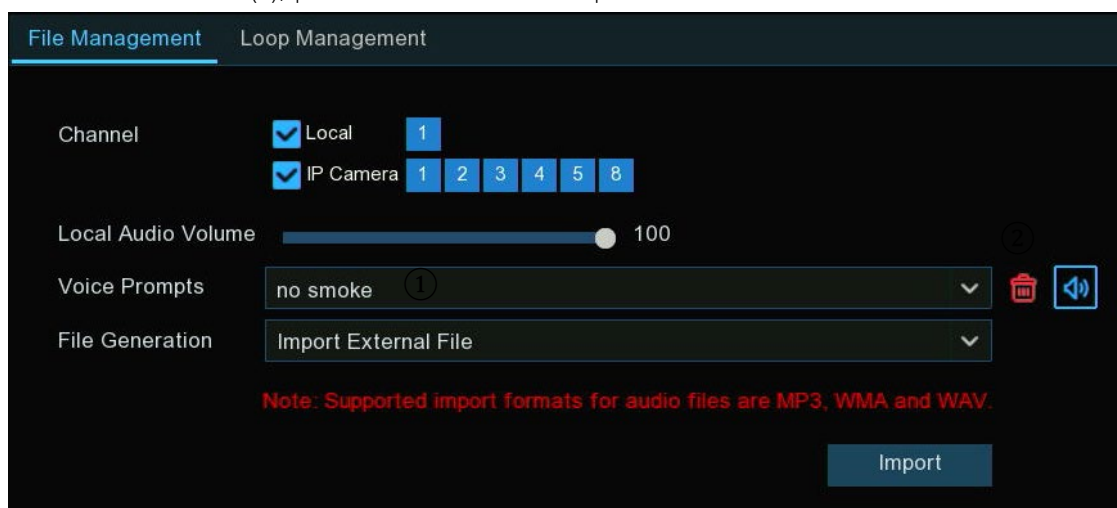

1. Select a voice file first.
2. Click the delete button  to delete the file.
3. Repeat steps 1 and 2 to delete another file.

5.3.8.1.2 Auditioning Voice

After creating your voice files, you can audition them using your NVR and/or IP camera's speaker.

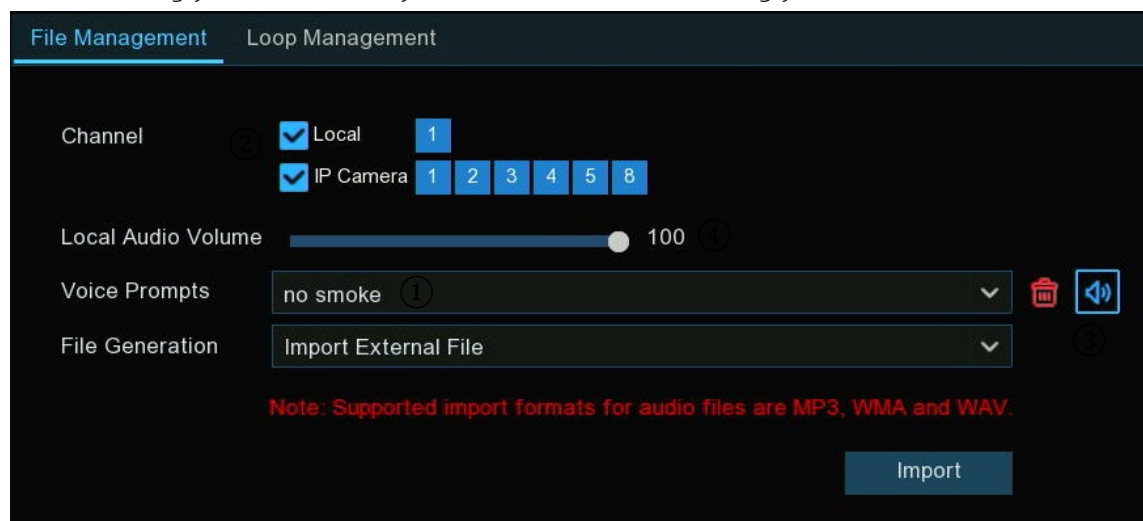



1. Select a voice file first.
2. Choose the voice playback device. Local indicates the NVR's audio output device, IP Camera indicates the speaker or audio output device in the IP camera(s).
3. Click the play button to audition.
4. You can drag the slider bar to adjust the volume for local playing on the NVR.

5.3.8.2 Loop Management

The system allows you to play a continuous loop of voices over a certain period of time. After selecting an audio file and setting a time period, the selected audio file will loop and play continuously during that time period when there are no voice announcements for alarms or when auditioning the audio file.



1. Select the play device(s).
2. Choose a voice file.
3. Set the time period.
4. Click the play button  to start audition.
5. Click the add button  to add another loop playlist. A maximum of 12 playlists can be set. The time periods for different playlists cannot overlap



6. To delete a loop playlist, click the delete button .
7. Click [Apply](#) to save your settings.

5.3.8.3 Voice Prompt for Alarm Events

In addition to regular loop playback, you can also set dedicated alarm voices for detected alarm events.

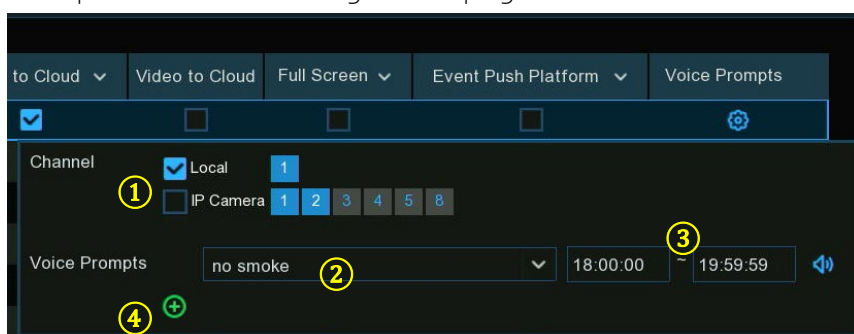
In the alarm settings that support Voice Prompts, click on the settings button  below Voice Prompts to enter the configuration page.



1. Select the play device(s).
2. Choose a voice file.
3. Set the time period.
4. You can click the add button  to add another playlist. A maximum of 12 playlists can be set. The time periods for different playlists cannot overlap. If you have set a Loop playback, the time periods also cannot overlap with the Loop play time.
5. To delete a play playlist, click the delete button .
6. Click [Apply](#) to save your settings.

5.3.9 Deterrence

If your camera has a built-in white light (also known as "spotlights" or "flood lights") or red/blue lights, they can serve as a deterrence when an alarm is triggered. This can make intruders feel detected and help prevent illegal behavior.

Please note: if your camera is a full color camera with white lights, you can only configure the Deterrence settings when the Image Mode is set to Normal Day/Night mode. Please refer to section [5.1.3 Image Control](#) for more details on the color mode setting.

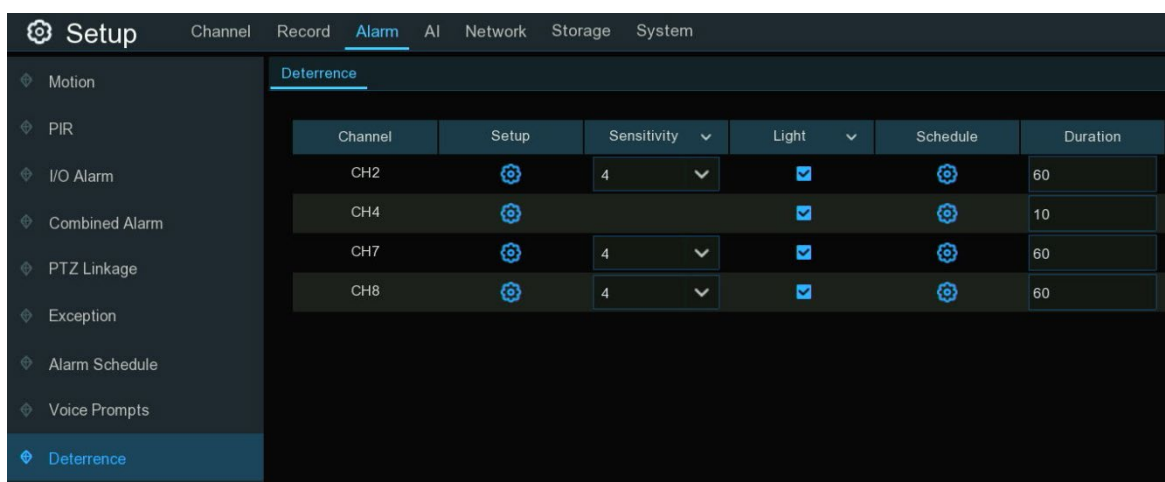

Sensitivity: It has no effect here.

Light: Turn the white light warning on or off.

Duration: This lets you change the length of time (in seconds) the white light will remain lit when an alarm is detected. Adjust accordingly.

If you have cameras with red/blue warning lights connected, you will also see the following menu options in the interface:

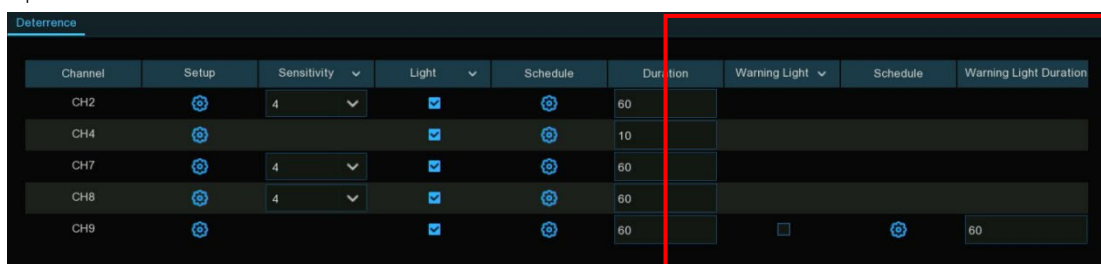

Warning Light: Turn the red/blue warning light on or off.

Warning Light Duration: Set the duration (in seconds) for how long the red/blue warning light will remain lit when an alarm is triggered. Click the Setup button to enter detailed configuration page for each camera. Depending on the camera model, you may see different configuration pages for the white light and red/blue warning lights. Here are some common configuration options:

- For PIR Camera:

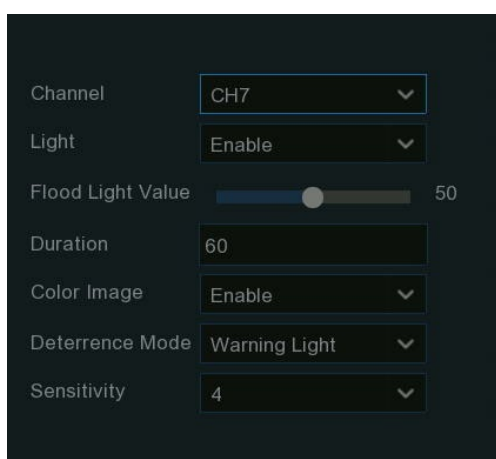

Light: Turn the white light warning on or off.

Flood Light Value: Drag the slider to adjust the brightness of the white light.

Duration: This lets you change the length of time (in seconds) the white light will remain lit when an alarm is detected. Adjust accordingly.

Color Image: If enabled, the night vision images will be colored. If disabled, the night vision images will remain black & white.

Deterrence Mode: Click the drop-down menu to select a solid light (Warning Light) or a flashing light (Strobe Light). When picking Strobe Light, you can select a low, medium or high Strobe Frequency setting.

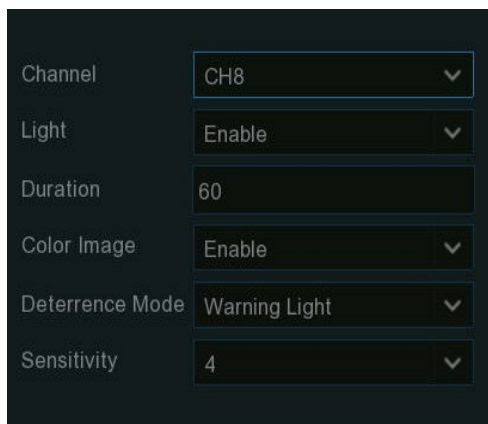

- **For Full Color Camera:**

Light: Turn the white light warning on or off.

Duration: This lets you change the length of time (in seconds) the white light will remain lit when an alarm is detected. Adjust accordingly.

Color Image: If enabled, the night vision images will be colored.

If disabled, the night vision images will remain black & white.

Deterrence Mode: Click the drop-down menu to select a solid light (Warning Light) or a flashing light (Strobe Light). When picking Strobe Light, you can select a low, medium or high Strobe Frequency setting.

- **For Deterrence Camera with Red/Blue Lights:**

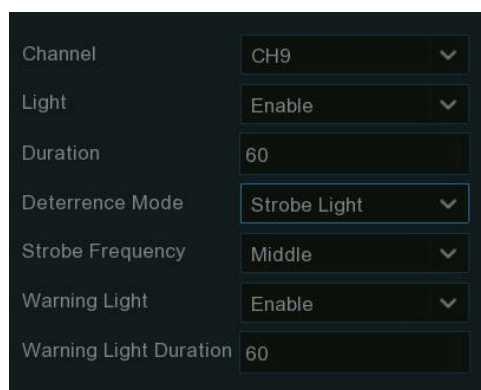

Light: Turn the white light warning on or off.

Duration: This lets you change the length of time (in seconds) the white light will remain lit when an alarm is detected. Adjust accordingly.

Deterrence Mode: Click the drop-down menu to select a solid light (Warning Light) or a flashing light (Strobe Light). When picking Strobe Light, you can select a low, medium or high Strobe Frequency setting.

Warning Light: Turn the red/blue warning light on or off.

Warning Light Duration: Set the duration (in seconds) for how long the red/blue warning light will remain lit when an alarm is triggered.

Using the schedule, you can control the time periods when the lights will be enabled. You can even set different light duration for different types of alarms. Click on the  icon below Schedule to open the settings page.

- When the camera is connected to the NVR with camera's **Media/Client** port, the setup page is shown below:

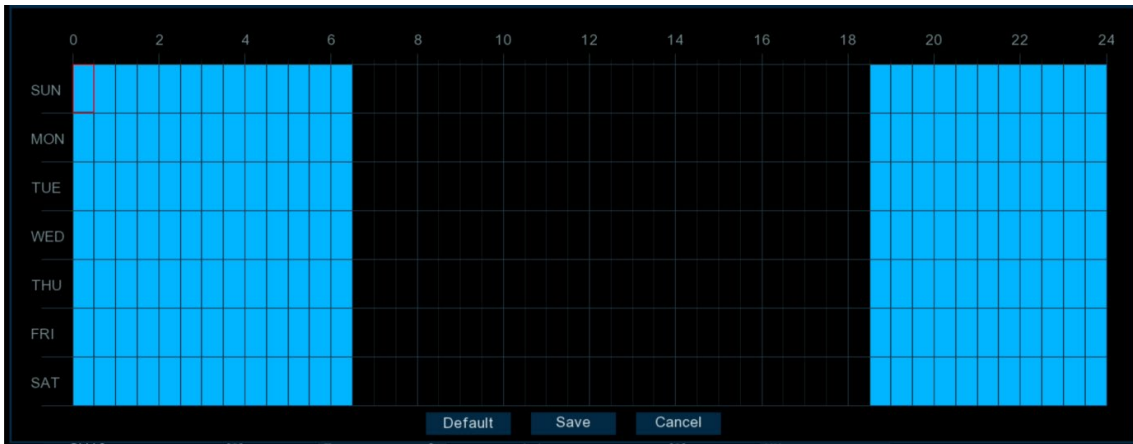

Click or drag the mouse on the schedule to select the time slots. The blue sections indicate the periods during which the warning lights will be activated if a qualifying alarm occurs.

- When the camera is connected to the NVR with camera's **http** port, the setup page is shown below:



1. Click on the radio button of the event you want to set.
2. Click or drag the mouse on the schedule to select the time slots. The blue sections indicate the periods during which the warning lights will be activated if the selected alarm occurs.
3. Click the Switch to activate the schedule.

5.3.10 Siren

If the connected camera has a built-in speaker, it can be configured as a siren in addition to performing the voice intercom function.

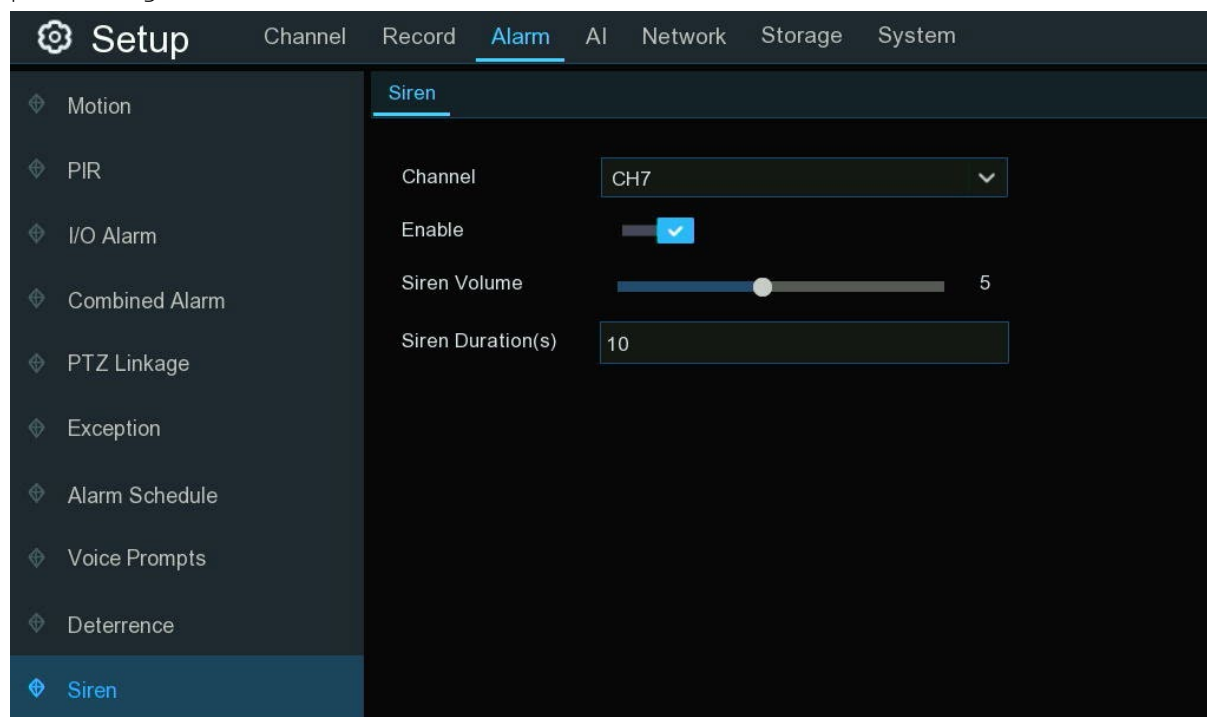

Depending on the model and features, the main setup methods are as follows:

- For PIR Camera:



Enable: Toggle to enable or disable the siren function.

Siren Volume: Set the siren volume level, ranging from 1 to 5. The higher the level, the louder the volume.

Siren Duration(s): Set the siren duration, adjustable between 5 to 180 seconds.

- For Deterrence Camera with Speaker:

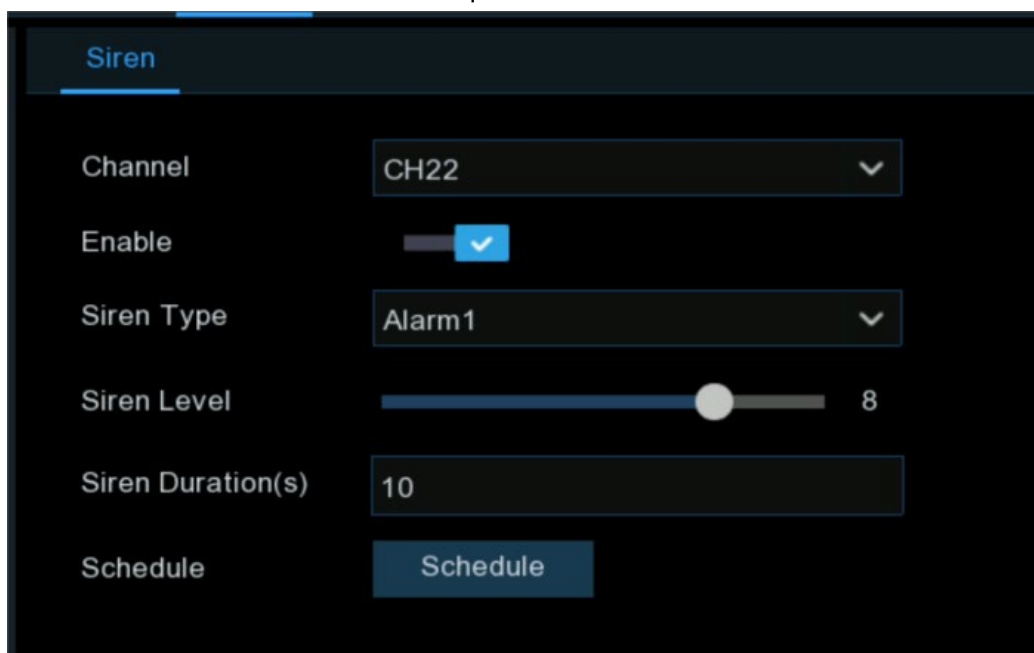

Enable: Toggle to enable or disable the siren function.

Siren Type: Used to select the siren audio file. Used to select the siren audio file. Depending on the model, the available alarm audio options may vary. Some models only allow you to select the built-in system alarm audio, while others allow you to upload up to three custom audio files. To use a custom audio file, select User-defined, and then upload the Pre-prepared audio file from a USB drive. The system supports importing PCM and WAV audio file formats. The imported audio file's sampling rate should not exceed 8000Hz, and the file size should not exceed 256KB. Once a custom audio file is selected, a Delete button will appear on the right side, allowing you to remove the current audio file.

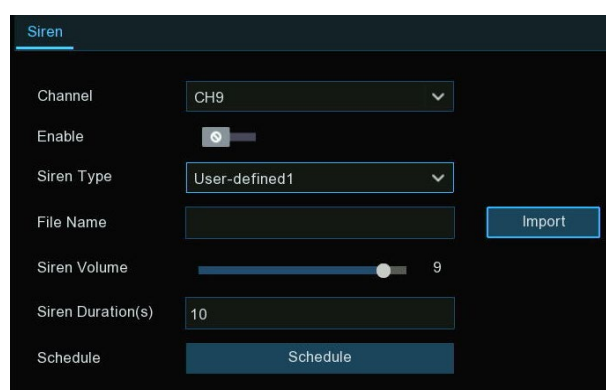
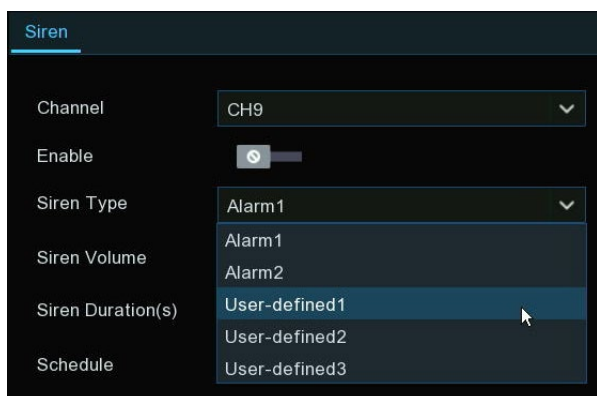

Siren Volume: Used to set the siren volume level, which ranges from 1 to 8. The higher the level is, the louder the volume is.

Siren Duration(s): Used to set the siren duration. You can adjust the value between 5 to 180 seconds.

Schedule: If the IP camera is connected to the NVR via the HTTP port, you can click the [Schedule](#) button to open the setting page.

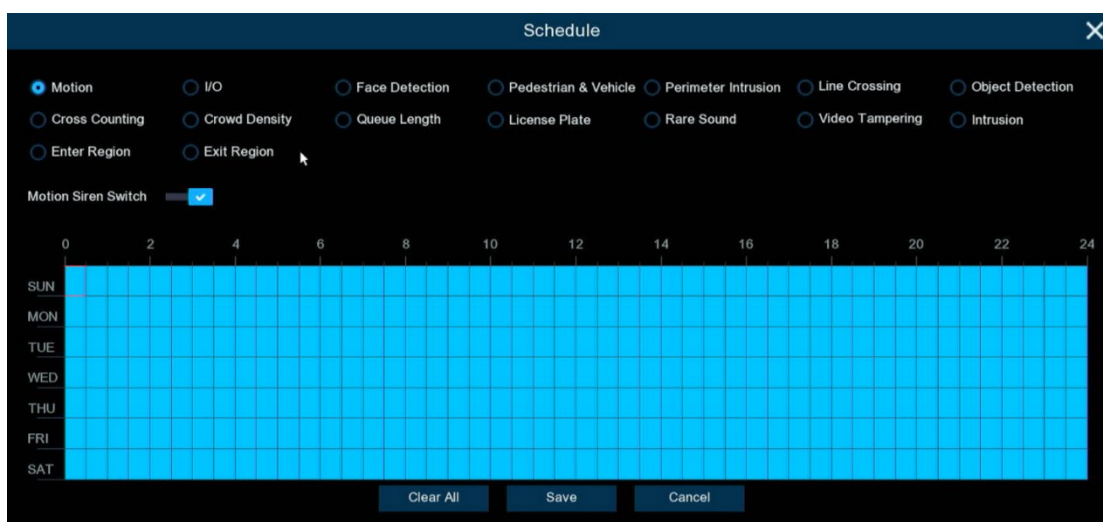

1. Click on the radio button of the event you want to set.
2. Click or drag the mouse on the schedule to select the time slots. The blue sections indicate the periods during which the warning lights will be activated if the selected alarm occurs.
3. Click the Switch to activate the schedule.

5.3.11 Alarm Disarm

Using the one-click disarming function, you can combine it with schedules to suppress alert behaviors for detected alarm events during specific time periods.

For example, you can disable the buzzer, alarm output, message display, email alerts, full-screen display, voice prompts, event push to platforms, and mobile push notifications. This allows you to avoid from receiving frequent alarms during known, manageable, and frequently occurring event types.

Note: System exception alarms are not controlled by one-click disarming.

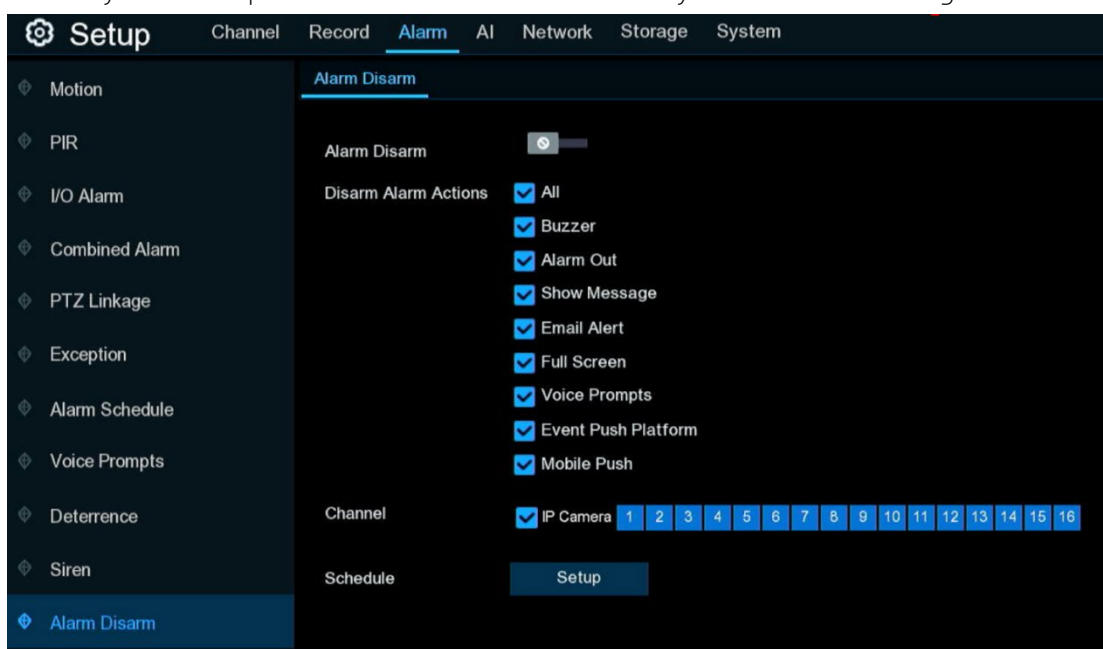

Alarm Disarm: Set to enable or disable the one-click disarming function.

Disarm Alarm Action: Used to set the alarm linkage types to be disarmed.

All: Select or deselect all types.

Buzzer: Enable to disable the buzzer when an alarm is triggered while one-click disarming is enabled.

Alarm Out: Enable to disable external alarm output when an alarm is triggered while one-click disarming is enabled.

Show Message: Enable to prevent alarm messages from displaying on the preview page when a detection event triggers while one-click disarming is enabled.

Email Alert: Enable to prevent the NVR from automatically sending emails when an alarm is triggered while one-click disarming is enabled.

Full Screen: Enable to prevent channels configured for full-screen mode from entering full-screen on the preview screen when triggering an alarm while one-click disarming is enabled.

Voice Prompts: Enable to disable voice prompts on channels configured for voice prompts when an alarm is triggered while one-click disarming is enabled.

Event Push Platform: Enable to prevent the device from pushing alarm information to a third-party platform when an alarm is triggered while one-click disarming is enabled.

Mobile Push: Enable to prevent the device from pushing alarm information to the mobile app when an alarm is triggered while one-click disarming is enabled.

Channel: Select the channel(s) to be disarmed.

Schedule: Click the setup button to enter the schedule setup page and set time periods for one-click disarming.

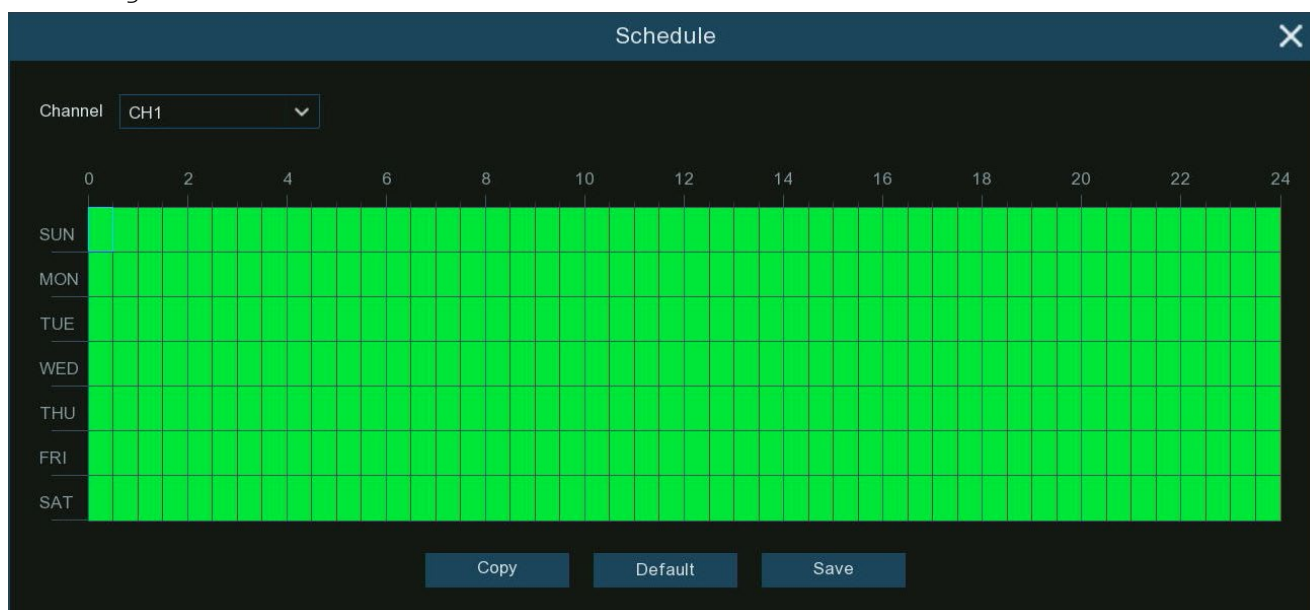

Click or drag the mouse on the schedule to select the time slots. The green sections indicate the periods during which the system will suppress alert behaviors for detected alarm events.

5.4 AI

AI (Artificial Intelligence) technology enables advanced functions like face detection, license plate recognition, and behavior analysis by using algorithms for intelligent video data analysis, allowing the system to detect various alarm events based on face, human, and vehicle detection with AI-powered IP cameras and take corresponding actions for a smarter surveillance experience. This section will be present if your NVR has AI capabilities.

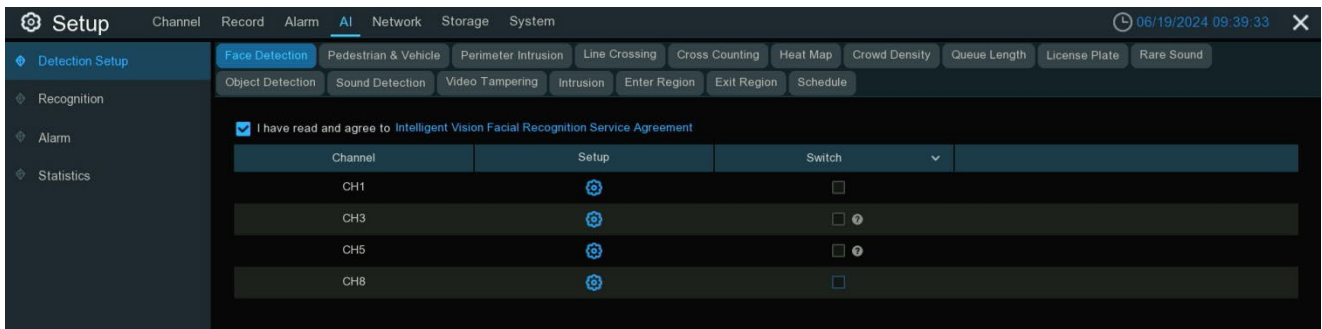

5.4.1 Detection Setup

Leveraging advanced AI algorithms, NVR and its accompanying cameras provide powerful intelligent detection capabilities suitable for various installation environments. You can flexibly configure the AI detection functions supported by the system, such as face recognition, license plate recognition, and behavior analysis, to optimize the sensitivity and accuracy of the detection algorithms based on your actual needs. The specific AI detection features available may vary across different NVR and camera models. Please refer to your actual setup for the configurable options. With proper configuration, these intelligent analysis functions can operate efficiently and accurately, enhancing the overall value of the surveillance system.

5.4.1.1 Face Detection

This menu allows you to set parameters related to face detection. To enable the face detection function, you need to read and agree to the "Intelligent Vision Facial Recognition Service Agreement".

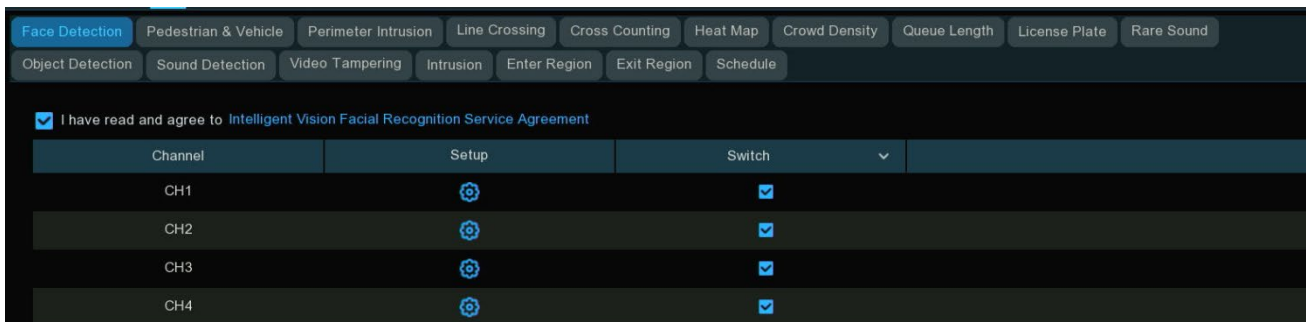

Switch: Tick the checkbox to enable the face detection feature.

Setup: Click setup  button for further settings:



The screenshot shows a configuration window for face detection. It includes the following settings:

- Channel: CH1
- Capture Mode: Interval Mode
- Snapshot Qty: 1
- Capture Interval: 2 s/pic(1-255)
- Face Angle: User-defined
- Roll Angel: 180 (0-180)
- Pitch Angle: 180 (0-180)
- Yaw Angle: 180 (0-180)
- Picture Quality: 100 (0-100)
- View Modes: Frontal View (selected), Multi-angle
- Min. Pixels: 32 (slider at 64), 1080
- Max. Pixels: 320 (slider at 640), 1080
- Face Enhance: Enable
- Face Attributes: Enable
- Detection Mode: Motion Mode
- Trigger Mode: Rectangle
- Detection Area: Full Screen
- Bounding Box: Enable
- Save button

Channel: Select the channel you want to configure face detection for.

Capture Mode: Used to set the method for capturing snapshots when a detection target is identified.

- **Optimal Mode:** Selects the best quality picture to push during the time from when the detection target appears to when it disappears

- **Real-time Mode:** Pushes once when the detection target appears and again when it disappears

- **Interval Mode:** Allows customizing the quantity of snapshots captured as well as the time interval between snapshot captures.

- **Snapshot Qty:** Set the number of snapshots to push for each detection target in interval mode

- **Capture Interval:** Set the frequency of pushing snapshots of detection target in interval mode

Face Angle: Set the angle at which faces will be captured/detected:

- **Front View:** Only detects frontal/forward-facing faces
- **Multi-angle:** Detects faces at multiple angles
- **User-defined:** Customize the angle ranges for roll (rotation), pitch (vertical tilt), and yaw (horizontal pan) that faces should be detected at
 - **Roll/Pitch/Yaw Angle:** Set the allowed rotation, vertical tilt, and horizontal pan angle ranges for face detection in user-defined angle mode.
 - **Picture Quality:** Set picture quality from 1 (lowest) to 100 (highest)
 - **Frontal view/Multi-angle:** Reset angle settings to defaults for frontal and multi-angle modes.

Min./Max. Pixels: Set the minimum and maximum pixel sizes for detected faces to be recognized.

Face Enhance: Enhance for better recognition of moving faces, may lower overall picture quality.

Face Attribute: After enabling this feature, the system will record the captured facial features, such as whether the person is wearing a mask or glasses, etc. Subsequently, when you search, you may be able to use these features to filter. This feature is only supported by some models, and due to product performance limitations, the recognized facial features may not be completely accurate.

Detection Mode: This setting determines the method used to detect targets within the camera's field of view. There are two modes available, please choose according to your specific needs:

- **Hybrid Mode:** In this mode, both static and moving targets are detected. It combines detection of both stationary objects and those in motion. Hybrid mode is beneficial in scenarios where both static and moving objects may be of interest for surveillance.

- **Motion Mode:** This mode exclusively detects moving targets within the frame. It focuses solely on identifying objects in motion, ignoring stationary elements.

Trigger Mode: Used to set the area and path for triggering target detection, it allows you to customize the area or path that triggers detection, enabling the system to focus on the specific areas and movement paths you are concerned about.

- **Rectangle:** In this mode, you can draw a rectangular area as the detection area. Any targets entering this area will be detected and trigger the corresponding alarms or actions.
 - **Detection Area:** For Rectangle mode, set the detection area. You can either select Full Screen detection, or choose User-defined to adjust the size of the quadrilateral detection area.
- **Line:** Under the Line mode, you need to draw a line inside the preview area, and set the crossing direction Rule Type (A->B or B->A) so that when a face crosses the line according to the set rule, it will be detected and trigger a response - suitable for scenarios requiring monitoring of targets crossing a certain path or boundary line.

Bounding Box: When enabled, a green bounding box will be displayed on the images, outlining and identifying detected targets. This aids in quickly locating and recognizing captured objects of interest.

5.4.1.2 Pedestrian & Vehicle Detection

This menu allows you to set parameters related to detect pedestrian beings and/or vehicles.

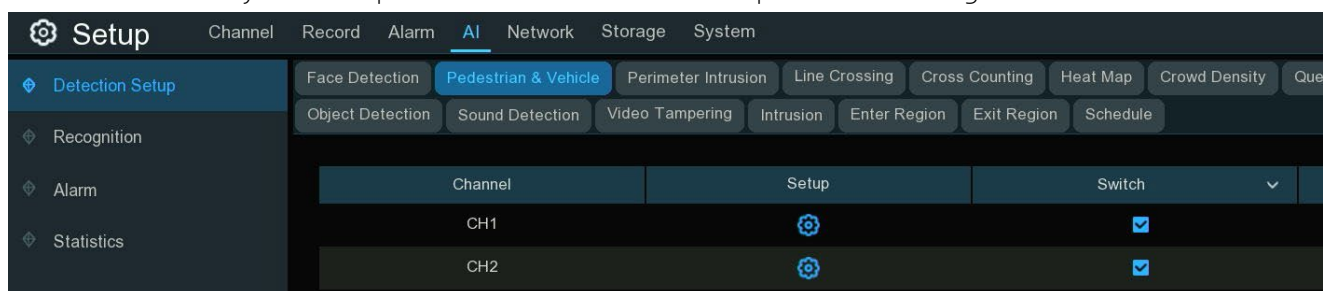

Switch: Tick the checkbox to enable the human & vehicle detection.

Setup: Click setup button for further settings:

Channel: CH3

Capture Mode: Default

Min. Pixels: 64 (slider from 64 to 1080)

Max. Pixels: 320 (slider from 320 to 1080)

Sensitivity: 60 (1-100)

Detection Target: Pedestrian, Motor Vehicle, Non-motorized Vehicle

Detection Mode: Motion Mode

Detection Area: Full Screen

Bounding Box: Enable

Save

Channel: Select the channel you want to configure the detection for.

Capture Mode: Used to set the method for capturing snapshots when a detection target is identified.

- **Default Mode:** Selects the best quality picture to push during the time from when the detection target appears to when it disappears
- **Real-time Mode:** Pushes once when the detection target appears and again when it disappears
- **Interval Mode:** Allows customizing the quantity of snapshots captured as well as the time interval between snapshot captures
 - **Snapshot Qty:** Set the number of snapshots to push for each detection target in interval mode

- **Capture Interval:** Set the frequency of pushing snapshots of detection target in interval mode

Min./Max. Pixels: Set the minimum and maximum pixel sizes for detected targets to be recognized.

Sensitivity: Set the sensitivity level, ranging from 1 to 100. The higher the value, the more easily it will be triggered.

Detection Target: Choose the detection target object. You can select from Pedestrian, Motor Vehicle, and Non-motorized Vehicle.

Detection Mode: This setting determines the method used to detect targets within the camera's field of view. There are two modes available, please choose according to your specific needs:

- **Hybrid Mode:** In this mode, both static and moving targets are detected. It combines detection of both stationary objects and those in motion. Hybrid mode is beneficial in scenarios where both static and moving objects may be of interest for surveillance.
- **Motion Mode:** This mode exclusively detects moving targets within the frame. It focuses solely on identifying objects in motion, ignoring stationary elements.
 - **Detection Area:** Used to set the area for triggering target detection, it allows you to customize the area, enabling the system to focus on the specific areas you are concerned about. You can either select Full Screen detection, or choose User-defined to adjust the size of the quadrilateral detection area.

Bounding Box: When enabled, a green bounding box will be displayed on the images, outlining and identifying detected targets. This aids in quickly locating and recognizing captured objects of interest.

5.4.1.3 Perimeter Intrusion Detection

Perimeter Intrusion Detection is used to monitor predefined virtual areas for the presence of people and/or vehicles entering or exiting.

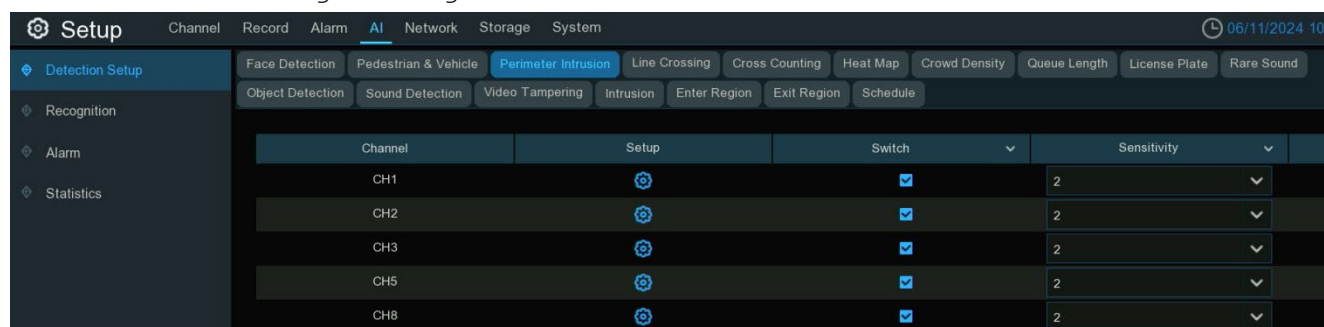

Switch: To Enable or disable the Perimeter Intrusion Detection function.

Sensitivity: Set sensitivity levels from 1 to 4. Higher sensitivity will trigger detection more easily, but it may correspondingly increase false detection.

Setup: Click the configuration button to set detection conditions.

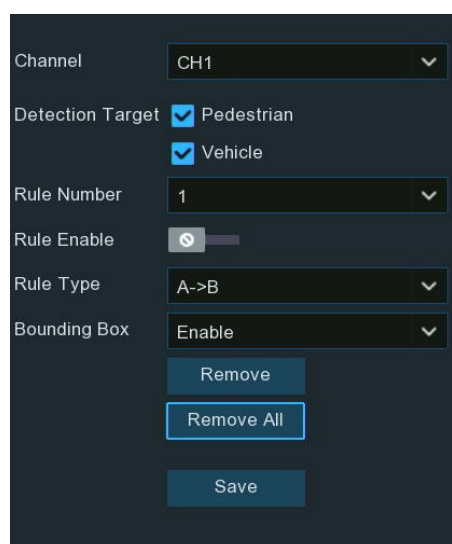

Channel: Select the channel you want to configure.

Detection Target: Choose the type of detection from Pedestrian and/or Vehicle. For certain models, you can further distinguish between Motor Vehicle and Non-motorized Vehicle in the detection target.

Rule Number: You can set up to 4 areas for perimeter intrusion detection.

Bounding Box: When enabled, a green bounding box will be displayed on the images, outlining and identifying detected targets. This aids in quickly locating and recognizing captured objects of interest.

The method for setting the detection area is as follows:

1. Select an area number from **Rule Number**.
2. Toggle the **Rule Enable** switch to turn it on.
3. In the preview screen, use your mouse to click four points on the camera image to draw a convex polygon (concave polygons cannot be saved). The area inside the quadrilateral is the detection area.
4. If you need to adjust the drawn area, click the box at the top left corner of the quadrilateral. The box lines will turn red. Click any corner box and drag to adjust the size. You can also click any edge and drag to move the entire quadrilateral.

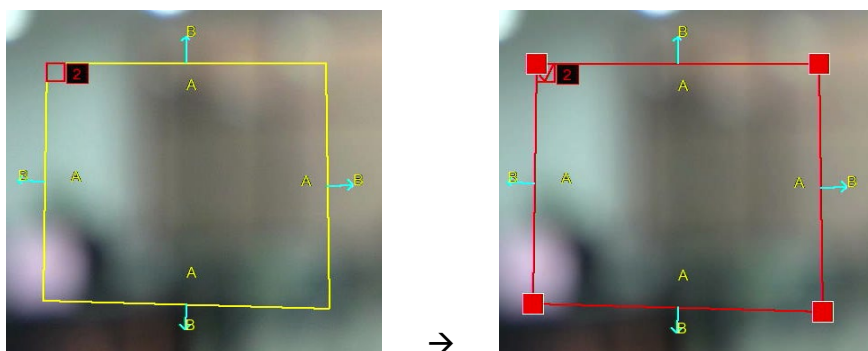

5. In **Rule Type**, you can set the direction for detecting objects entering or exiting the detection area.
 - **A→B**: Detects actions from side A to side B.
 - **B→A**: Detects actions from side B to side A.
 - **A↔B**: Detects actions from either side A to side B or side B to side A.
6. After making adjustments, click the **Save** button to save the changes.
7. If you need to delete a specific area, click the box next to the area number you want to delete in the preview screen, then click **Remove** to delete it. You can also click **Remove All** to delete all set areas.
8. After deleting, click the **Save** button to save the changes.

Note:

- 1) The perimeter should not be too close to the edges/corners of the camera image to ensure detection is triggered when a target passes through the edge/corner.
- 2) The shape of the area should not be too narrow or small to ensure detection when a large target passes through the perimeter.

5.4.1.4 Line Crossing Detection

Line Crossing Detection is a technology used to monitor predefined virtual boundaries or lines within a video or image feed. It is designed to detect when objects, such as people or vehicles, cross these virtual lines or boundaries in either direction (entering or exiting).

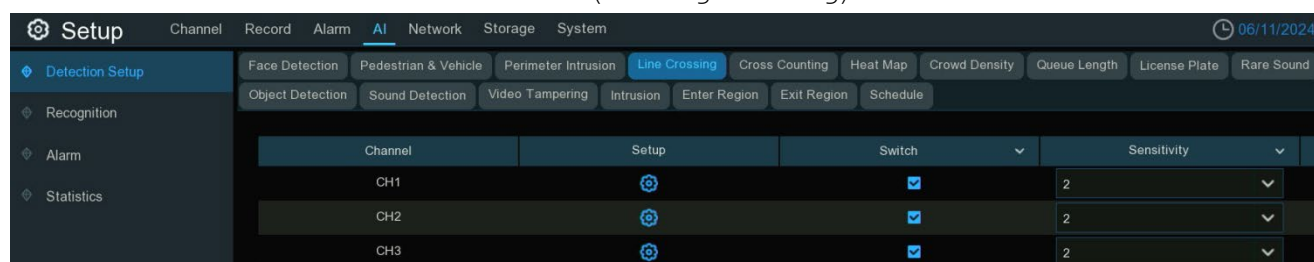

Switch: To Enable or disable the Line Crossing Detection function.

Sensitivity: Set sensitivity levels from 1 to 4. Higher sensitivity will trigger detection more easily, but it may correspondingly increase false detection.

Setup: Click the configuration button  to set detection conditions.

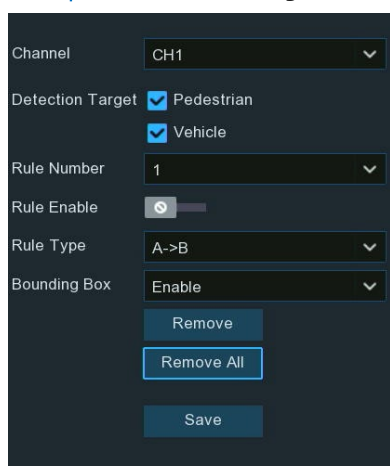

Channel: Select the channel you want to configure.

Detection Target: Choose the type of detection from Pedestrian and/or Vehicle. For certain models, you can further distinguish between Motor Vehicle and Non-motorized Vehicle in the detection target.

Rule Number: You can set up to 4 lines for line crossing detection.

Bounding Box: When enabled, a green bounding box will be displayed on the images, outlining and identifying detected targets. This aids in quickly locating and recognizing captured objects of

interest.

The method for setting the detection boundaries or lines is as follows:

1. Select a line number from **Rule Number**.
2. Toggle the **Rule Enable** switch to turn it on.
3. In the preview screen, use your mouse to click two points on the camera image to draw a virtual line.
4. If you need to modify the line, first click the box next to the line number, and the line will turn red. At this time, you can click on the boxes on both sides of the line and drag them to adjust the length and position. You can also directly press the line and move the entire line to change its position.

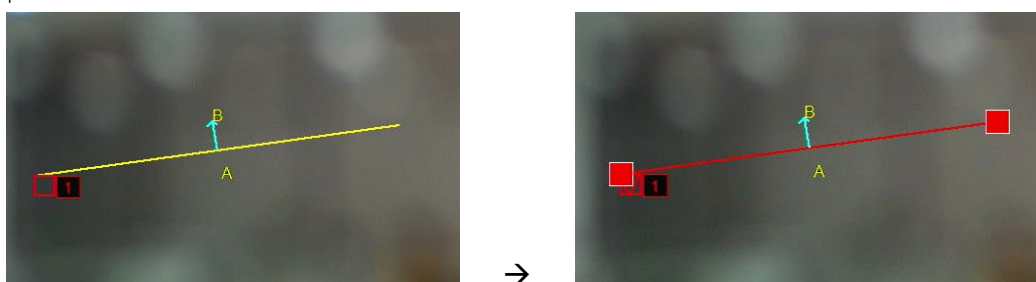

5. In **Rule Type**, you can set the direction for detecting objects crossing the line
 - **A→B:** Detects actions from side A to side B.
 - **B→A:** Detects actions from side B to side A.
 - **A↔B:** Detects actions from either side A to side B or side B to side A.
6. After making adjustments, click the **Save** button to save the changes.
7. If you need to delete a specific line, click the box next to the line number you want to delete in the preview screen, then click **Remove** to delete it. You can also click **Remove All** to delete all set lines.
8. After deleting, click the **Save** button to save the changes.

Note:

- 1) The line should not be placed too close to the edges of the camera image, as it may fail to trigger an alert when a target passes through the camera's field of view.
- 2) The line should not be set too short, as it may fail to trigger an alert when a target crosses over it.

5.4.1.5 Cross Counting

Crossing count function counts people, vehicles, vehicles, or any moving objects that cross the virtual line.

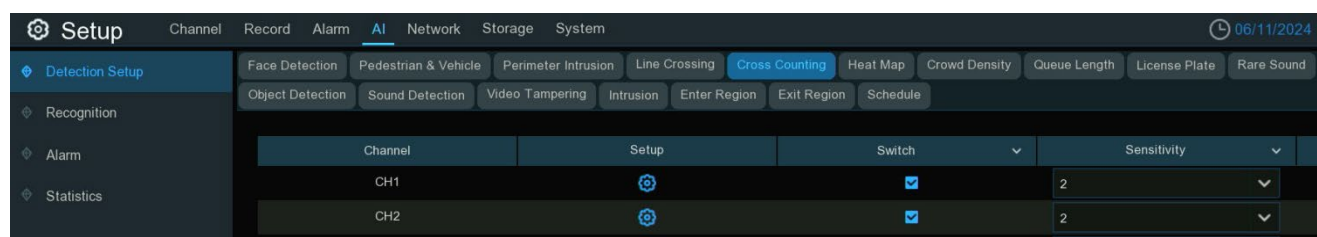

Switch: To Enable or disable the Line Crossing Detection function.

Sensitivity: Set sensitivity levels from 1 to 4. Higher sensitivity will trigger detection more easily, but it may correspondingly increase false detection.

Setup: Click the configuration button to set detection conditions.

The configuration dialog box includes the following fields and controls:

- Channel: CH1 (dropdown)
- Detection Target: Pedestrian (dropdown)
- Alarm Number: 1 (input field)
- Start Time: 00:00:00 (time picker)
- End Time: 23:59:59 (time picker)
- Recount: (button)
- Rule Number: 1 (dropdown)
- Rule Enable: (checkbox)
- Rule Type: A->B (dropdown)
- Bounding Box: Enable (dropdown)
- Remove: (button)
- Remove All: (button)
- Save: (button)

Channel: Select the channel you want to configure.

Detection Target: Choose the type of detection from Pedestrian, Vehicle (for certain models, you can further distinguish between Motor Vehicle and Non-motorized Vehicle) or motion. If you choose Motion, all moving subjects will be counted by the system.

Alarm Number: The system will trigger an alarm when the count reaches this set value. The Alarm Number = (number of cross in) - (number of cross out).

E.g. the number of cross in is 601 while the number of cross out is 400, and the alarm number you set is 200, $601 - 400 = 201 > 200$, then the NVR will send an alert.

Start Time: Set the start time of counting.

End Time: Set the end time of counting.

Recount: Clear the count number to zero and recount.

Rule Number: Select the rule number. It represents the number of virtual lines on which the Crossing Count function can be enabled. The current system only supports drawing one line.

Bounding Box: When enabled, a green bounding box will be displayed on the images, outlining and identifying detected targets. This aids in quickly locating and recognizing captured objects of interest.

The method for setting the detection line is as follows:

1. Toggle the **Rule Enable** switch to turn it on.
2. In the preview screen, use your mouse to click two points on the camera image to draw a virtual line.
3. If you need to modify the line, first click the box next to the line number, and the line will turn red. At this time, you can click on the boxes on both sides of the line and drag them to adjust the length and position. You can also directly press the line and move the entire line to change its position.

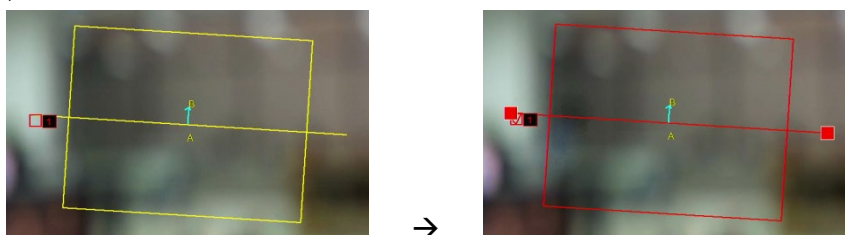

4. In **Rule Type**, you can set the direction for detecting objects crossing the line:
 - **A→B:** Detects actions from side A to side B.
 - **B→A:** Detects actions from side B to side A.
 - **A↔B:** Detects actions from either side A to side B or side B to side A.
5. After making adjustments, click the **Save** button to save the changes.
6. If you need to delete the line, click the box next to the line number you want to delete in the preview screen, then click **Remove** to delete it. You can also click **Remove All** to delete the line.
7. After deleting, click the **Save** button to save the changes.

Note:

- 1) The line should not be too close to the edge of the camera image, so as not to fail to trigger an alarm if the target crosses the line.
- 2) The line should be located in the area accessible to the detected object.
- 3) The line should not be set too short, so as not to fail to trigger the alarm when the target crosses the line.

5.4.1.6 Heat Map

A heat map is a graphical representation that highlights areas of interest or activity within the camera's field of view. It visualizes the areas where movement or activity is most concentrated, helping to identify hotspots or patterns of activity.

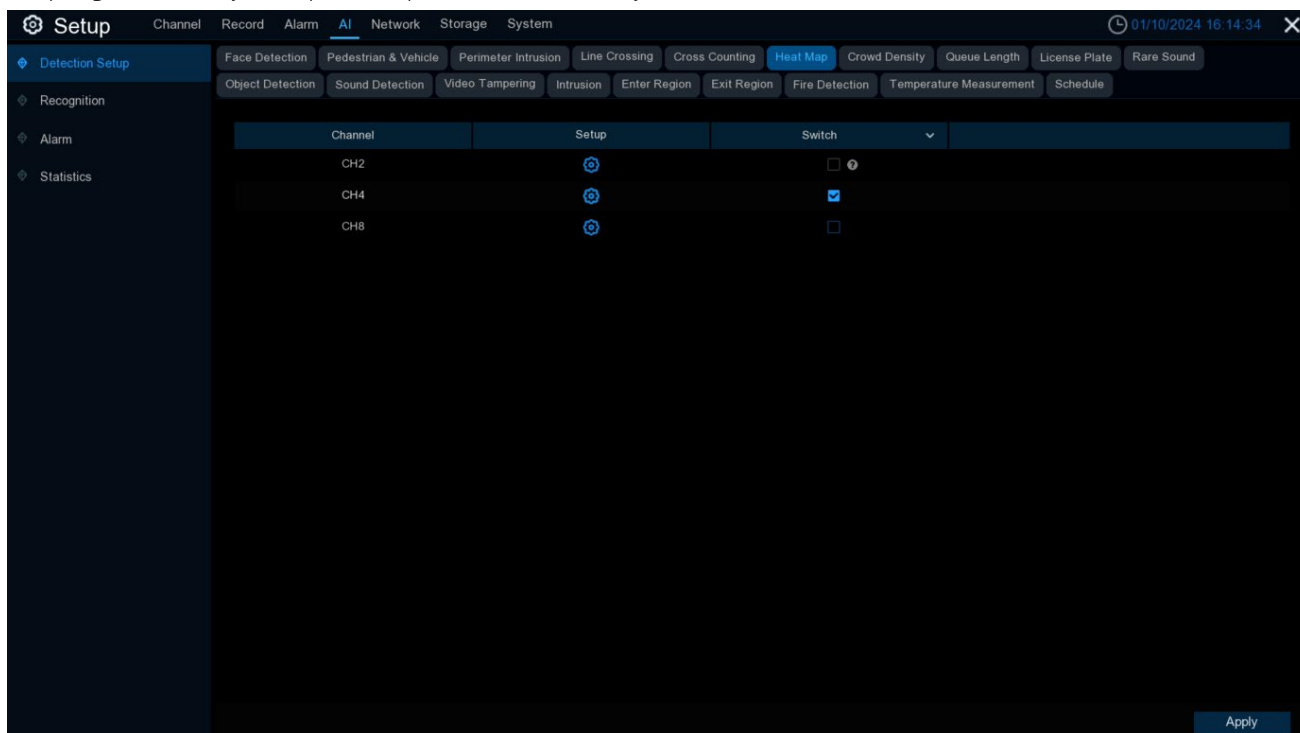

Switch: To enable or disable the heat map function.

Setup: Click to configure the detection area.

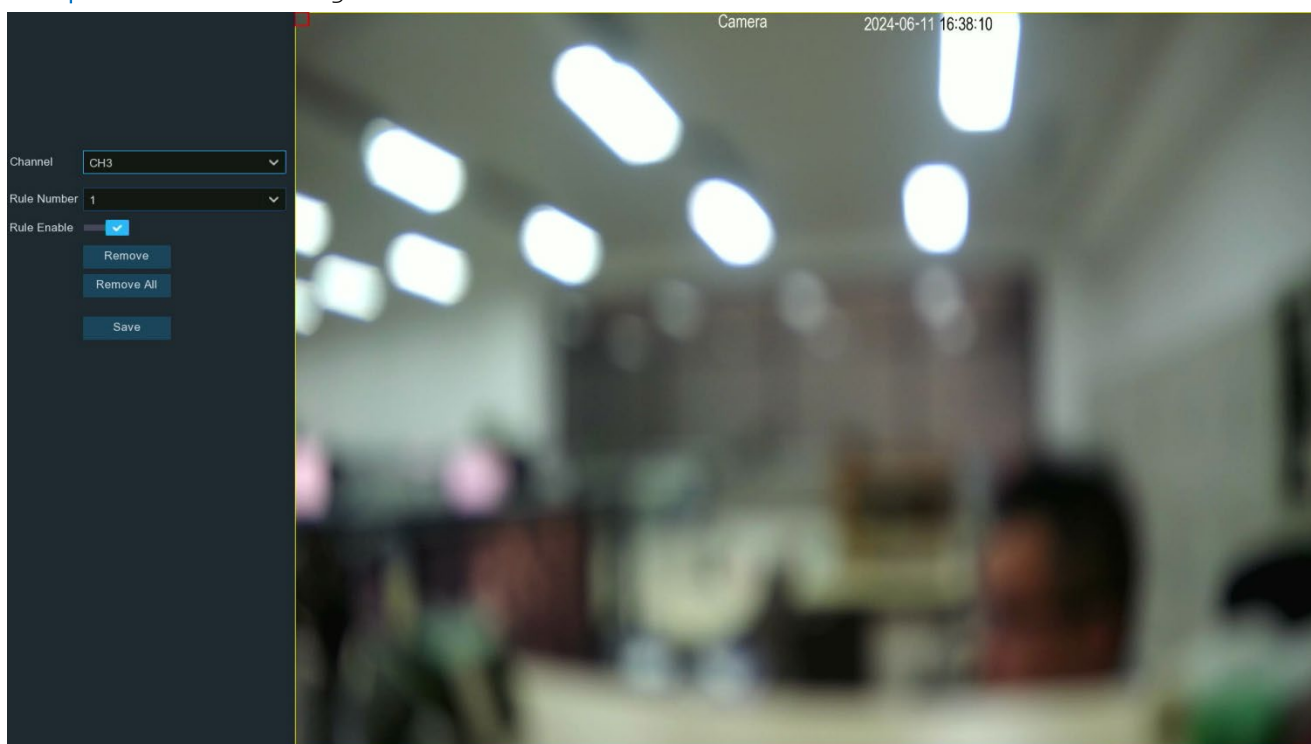

The method for setting the detection area is as follows:

1. Toggle the **Rule Enable** switch to turn it on.
2. When you enable the Heat Map feature for the first time, the system will default to setting the entire screen as the detection area. If you need to adjust the detection area, click the box at the top left corner of the quadrilateral. The box lines will turn red. Click any corner box and drag to adjust the size. You can also click any edge and drag to move the entire quadrilateral.

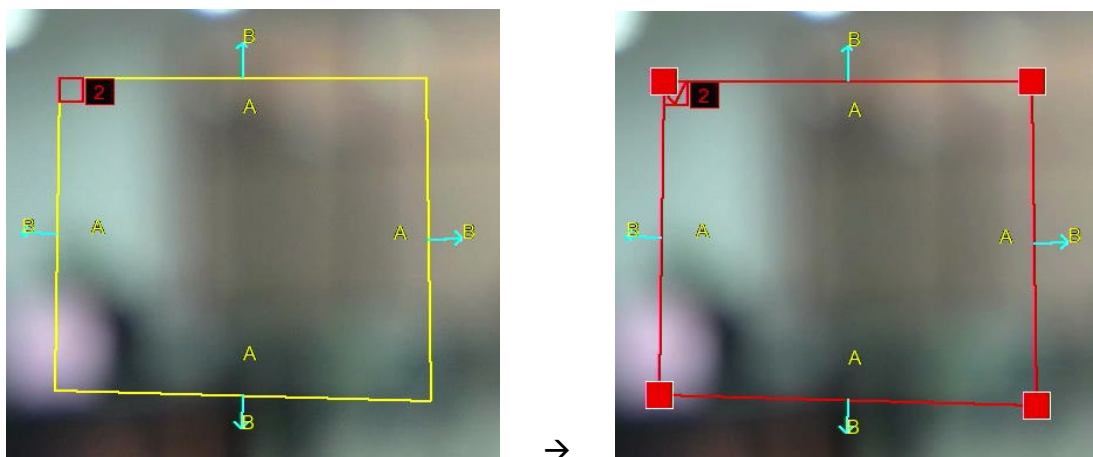

3. You can also click "**Remove All**" to delete previously defined areas, and then in the preview screen, use your mouse to click four points on the camera image to draw a convex polygon (concave polygons cannot be saved). The area inside the quadrilateral is the detection area.
4. After making adjustments, click the "**Save**" button to save the changes.

5.4.1.7 Crowd Density Detection

Crowd density detection is a feature that utilizes advanced video analytics and computer vision techniques to monitor and analyze the density of people within a designated area. It employs algorithms to detect, track, and count the number of individuals present within a defined region of interest in the camera's field of view, providing an estimation of the crowd size and density levels.

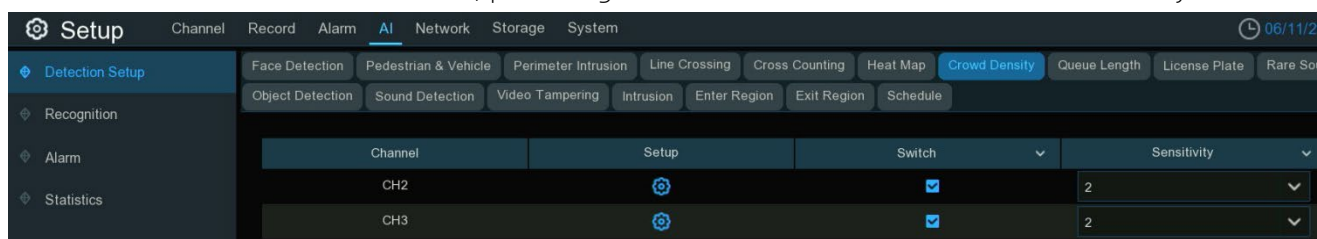

Switch: To enable or disable the Crowd Density detection function.

Sensitivity: Sensitivity levels are from 1 to 4. Higher sensitivity will trigger detection more easily, but it may correspondingly increase false detection.

Setup: Click to configure the detection conditions.

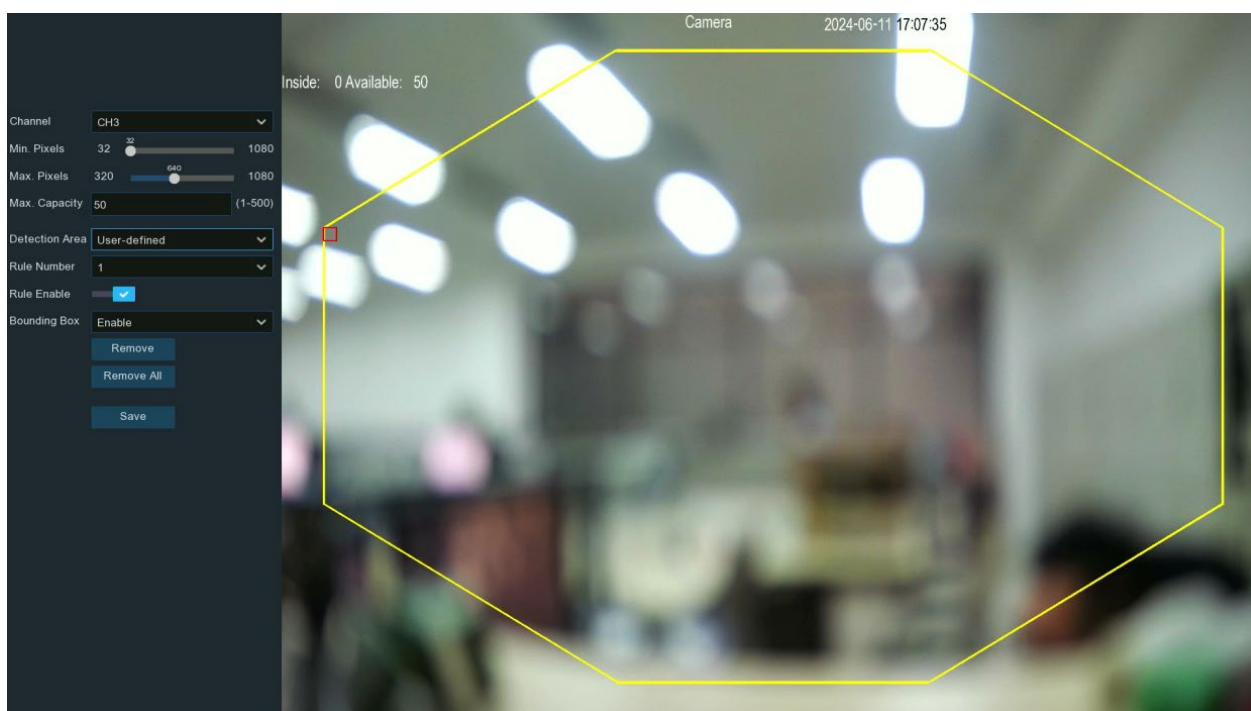

Channel: Select the channel you want to configure.

Min./Max. Pixels: Set the minimum and maximum pixel sizes for detected target to be recognized.

Max capacity: Used to set the maximum number of people allowed in the detection area. When the system detects that the number of people in the area exceeds this limit, it can trigger corresponding alarm actions.

Detection Area: Used to set the area for triggering target detection. You can either select Full Screen detection, or choose User-defined to adjust the size of the octagonal detection area. If you need to adjust the detection area, click the red box at the corner of the octagon. The box lines will turn red. Click any corner box and drag to adjust the size. You can also click any edge and drag to move the entire octagon.

Click **Save** to save the settings.

Bounding Box: When enabled, a green bounding box will be displayed on the images, outlining and identifying detected targets. This aids in quickly locating and recognizing captured objects of interest.

5.4.1.8 Queue Length Detection

Queue length detection is a video analytics feature used to monitor and analyze the status of queues or waiting lines. It provides insights into the length of the queue and the stall time (the duration for which people have been waiting in the queue).

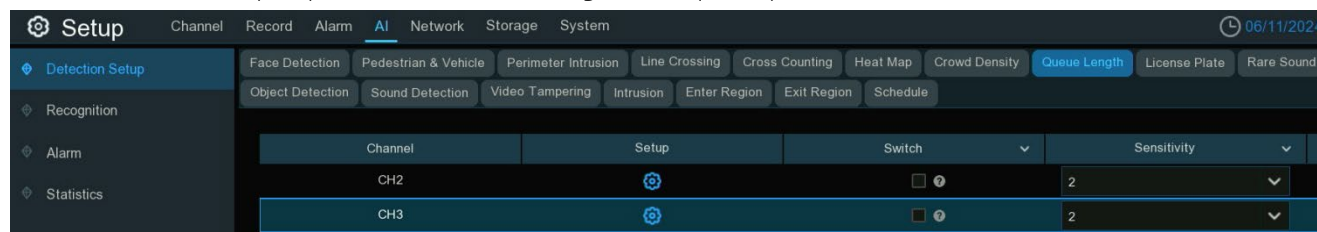

Switch: To enable or disable the Queue Length detection function.

Sensitivity: Sensitivity levels are from 1 to 4. Higher sensitivity will trigger detection more easily, but it may correspondingly increase false detection.

Setup: Click to configure the detection conditions.

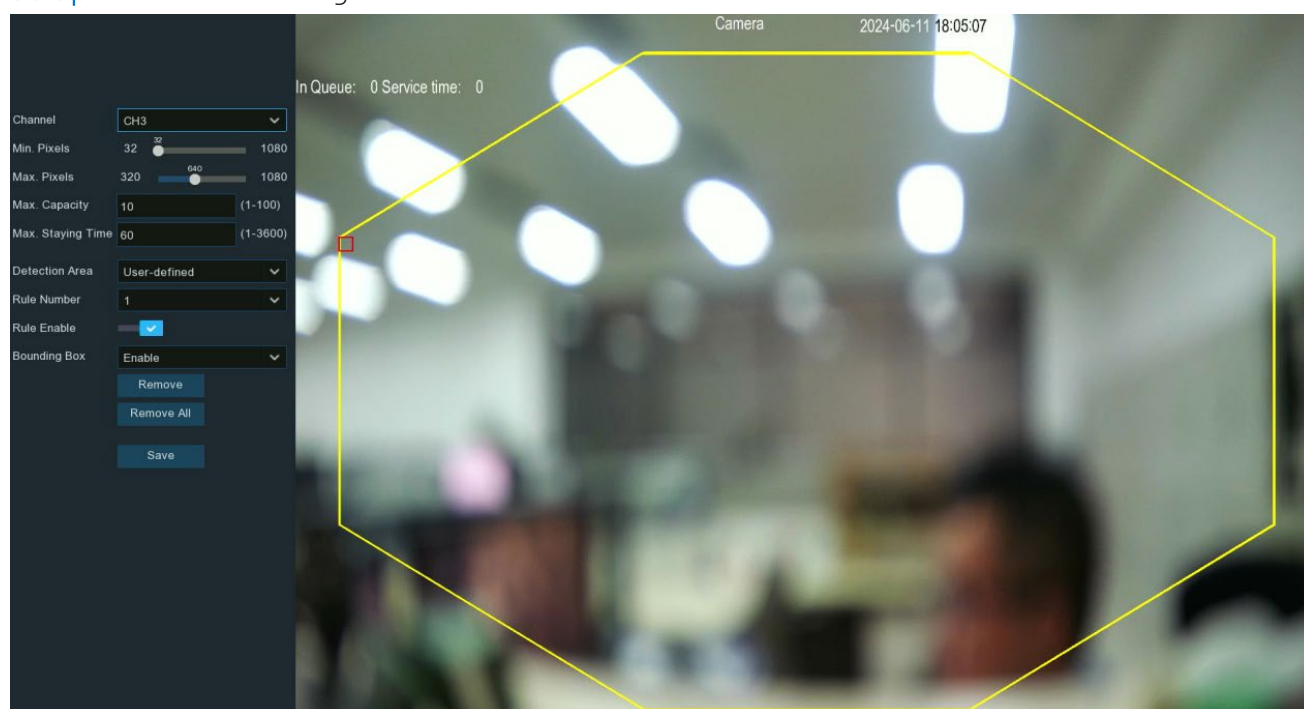

Channel: Select the channel you want to configure.

Min./Max. Pixels: Set the minimum and maximum pixel sizes for detected target to be recognized.

Max Capacity: The maximum allowable number of people in the queue. When the system detects that the queue length exceeds this limit, it can trigger corresponding alarm actions.

Max Staying Time: Set the maximum duration (in seconds) an individual can remain in the queue before the system triggers an alarm. This parameter helps ensure timely service and manage queue efficiency.

Detection Area: Used to set the area for triggering target detection. You can either select Full Screen detection, or choose User-defined to adjust the size of the quadrilateral detection area. If you need to adjust the detection area, click the red box at the corner of the octagon. The box lines will turn red.

Click any corner box and drag to adjust the size. You can also click any edge and drag to move the entire octagon.

Bounding Box: When enabled, a green bounding box will be displayed on the images, outlining and identifying detected targets. This aids in quickly locating and recognizing captured objects of interest.

Click **Save** to save the settings.

5.4.1.9 License Plate Detection

The License Plate detection function utilizes video analytics to detect and recognize the license plates of vehicles passing through the camera's field of view. In the License Plate menu, you can configure various parameters related to this detection function

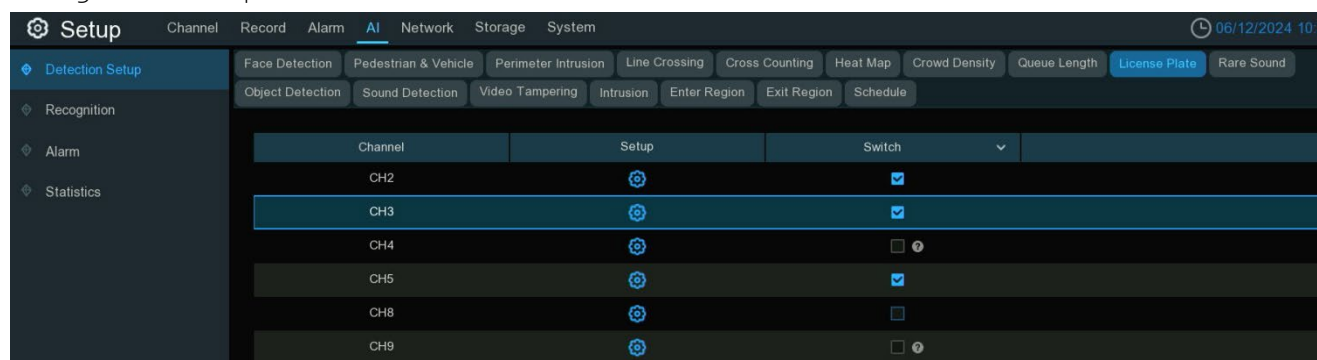

Switch: To enable or disable the License Plate detection function.

Setup: Click to configure the detection conditions.

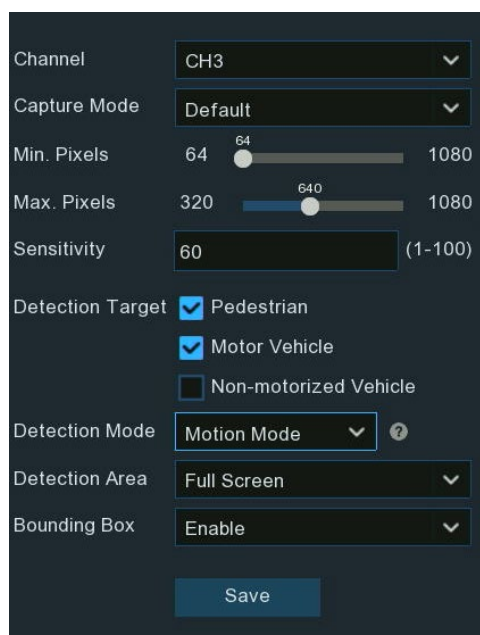

Capture Mode: Used to set the method for capturing snapshots when a detection target is identified.

- **Default Mode:** Selects the best quality picture to push during the time from when the detection target appears to when it disappears
- **Real-time Mode:** Pushes once when the detection target appears and again when it disappears
- **Interval Mode:** Allows customizing the quantity of snapshots captured as well as the time interval between snapshot captures
- **Snapshot Qty:** Set the number of snapshots to push for each detection target in interval mode

- **Capture Interval:** Set the frequency of pushing snapshots of detection target in interval mode

Min./Max. Pixels: Set the minimum and maximum pixel sizes for detected targets to be recognized.

Sensitivity: Set the sensitivity level, ranging from 1 to 100. The higher the value, the more easily it will be triggered.

Detection Target: Select the type of license plate, such as American license plates, European license plates, etc.

Detection Mode: This setting determines the method used to detect targets within the camera's field of view. There are two modes available, please choose according to your specific needs:

- **Hybrid Mode:** In this mode, both static and moving targets are detected. It combines detection of both stationary objects and those in motion. Hybrid mode is beneficial in scenarios where both static and moving objects may be of interest for surveillance.
- **Motion Mode:** This mode exclusively detects moving targets within the frame. It focuses solely on identifying objects in motion, ignoring stationary elements.

Detection Area: Used to set the area for triggering target detection, it allows you to customize the area, enabling the system to focus on the specific areas you are concerned about. You can either select Full Screen detection, or choose User-defined to adjust the size of the quadrilateral detection area.

Bounding Box: When enabled, a green bounding box will be displayed on the images, outlining and identifying detected targets. This aids in quickly locating and recognizing captured objects of interest.

For some models, you can also perform the following advanced settings:

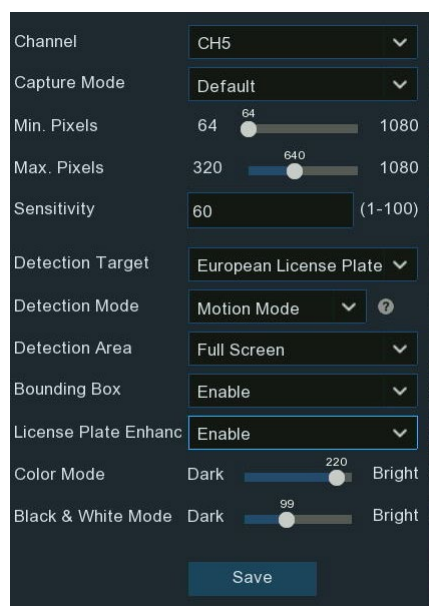

License Plate Enhance: Enable/disable license plate enhancement. License Plate Enhance is a feature that helps improve the clarity and readability of license plates in the captured images or video feed. Its main purpose is to enhance the license plate region, making it easier for the license plate detection algorithms to accurately recognize and identify the license plate characters.

Color Mode: Apply to full-color scenes. The higher the value, the brighter the screen; the lower the value, the darker the screen. The value can be set from 0-255.

Black & White Mode: Apply to black & white scenes. The higher the value, the brighter the image; the lower the value, the darker the image. The value can be set in the range of 0-255.

Note:

1. Enabling the License plate Enhance will cause the camera's brightness to be adjusted according to the set brightness value. The day and night levels will automatically switch based on whether the camera's infrared mode is enabled or not, without interfering with each other.
2. To use License Plate Enhance, you need to set Exposure Compensation to Off and Shutter to Auto mode on the Image Control page (refer to section [5.1.3 Image Control](#)). After enabling License Plate Enhance, you cannot modify Time Exposure.

5.4.1.10 Rare Sound

The Rare Sound Detection function allows the NVR (Network Video Recorder) to detect and alert you when it detects abnormal or specific sounds, such as a baby crying, a dog barking, or a gunshot.

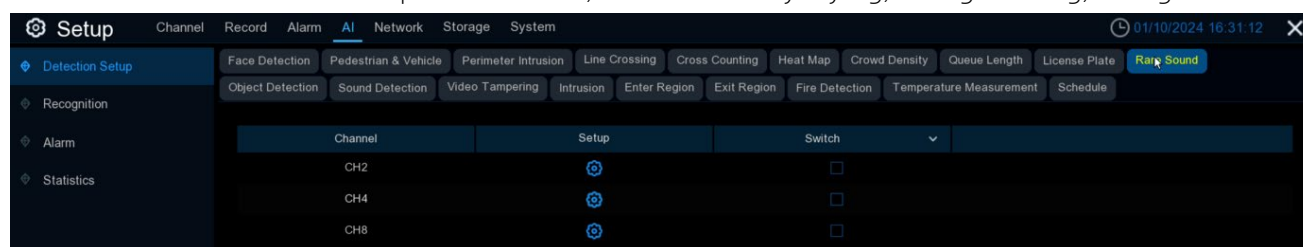

Switch: Tick the checkbox to enable the detection.

Setup: Click to configure the detection conditions.

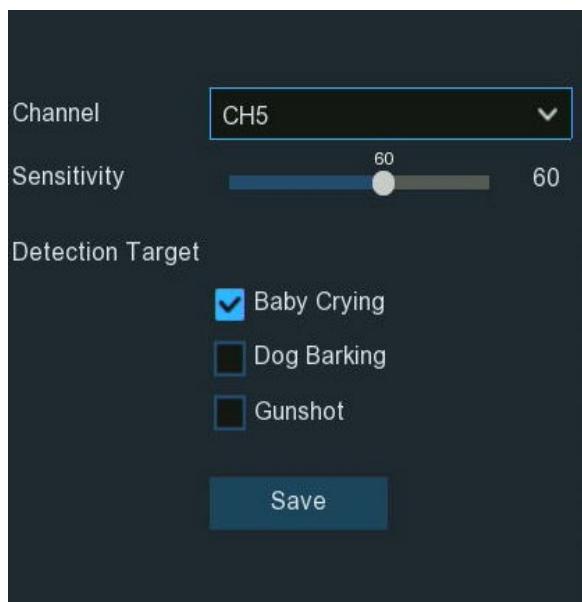

Channel: Select an available channel to configure.

Sensitivity: Adjust the sensitivity level for sound detection. The higher the number, the easier it is to trigger detection

Detection Target: Select the type of abnormal sound you need to detect:

- **Baby Crying :** Check this box to enable the detection of baby crying sounds.
- **Dog Barking:** Check this box to enable the detection of dog barking sounds.
- **Gunshot:** Check this box to enable the detection of gunshot sounds.

5.4.1.11 Object Detection

The Object Detection function identifies objects that are left behind or lost within a predefined region. This includes items such as baggage, purses, or potentially dangerous materials.

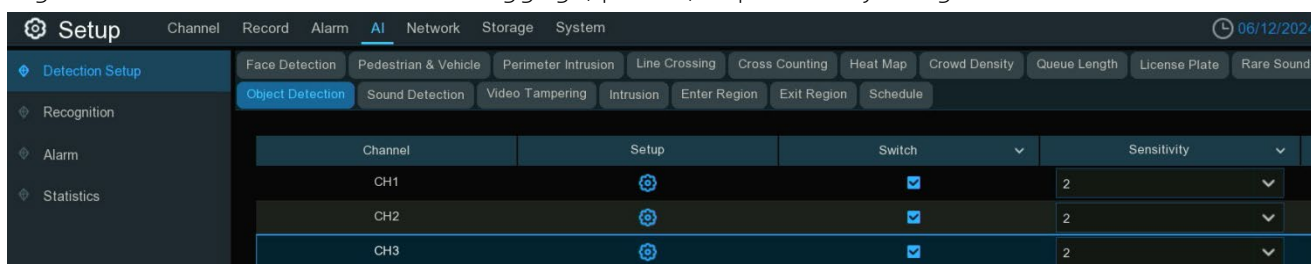

Switch: Check the box to enable the Object Detection function.

Sensitivity: Set sensitivity levels from 1 to 4. Higher sensitivity will trigger detection more easily, but it may correspondingly increase false detection.

Setup: Click to configure the detection conditions.

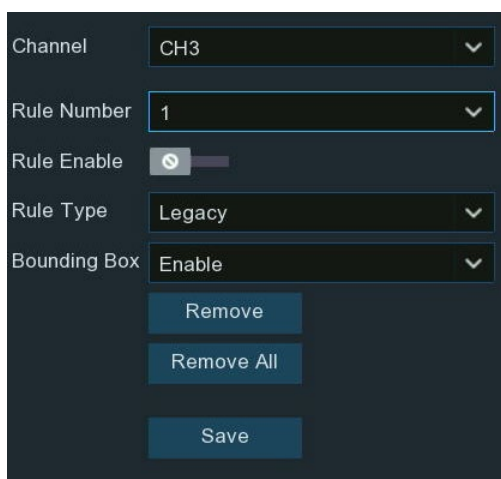

Channel: Select an available to configure.

Rule Number: You can set up to 4 areas for object detection.

Bounding Box: When enabled, a red bounding box will be displayed on the images, outlining and identifying detected targets. This aids in quickly locating and recognizing captured objects of interest.

The method for setting the detection area is as follows:

1. Select an area number from **Rule Number**.
2. Toggle the **Rule Enable** switch to turn it on.
3. In the preview screen, use your mouse to click four points on the camera image to draw a convex polygon (concave polygons cannot be saved). The area inside the quadrilateral is the detection area.
4. If you need to adjust the drawn area, click the box at the top left corner of the quadrilateral. The box lines will turn red. Click any corner box and drag to adjust the size. You can also click any edge and drag to move the entire quadrilateral.

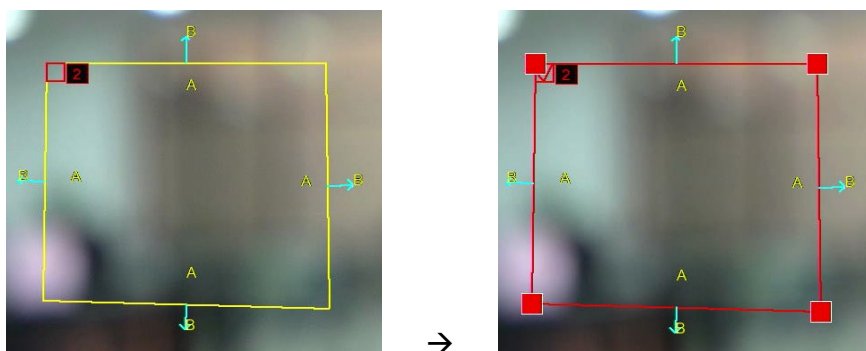

5. In **Rule Type**, you can select how the system should detect objects:
 - **Legacy**: The system will detect if any items are left behind within the defined region
 - **Loss**: The system will detect if any items are missing from the defined region
 - **Legacy & Loss**: The NVR will detect both items left behind and items missing from the defined region.
6. After making adjustments, click the **Save** button to save the changes.
7. If you need to delete a specific area, click the box next to the area number you want to delete in the preview screen, then click **Remove** to delete it. You can also click **Remove All** to delete all set areas.
8. After deleting, click the **Save** button to save the changes.

Note:

- 1) The detection area should be equal to or larger than the size of the detected objects.
- 2) The detected objects should not be obscured.

5.4.1.12 Sound Detection

The Sound Detection feature allows you to detect changes in sound levels. It can detect both increases and decreases in sound, which can be useful for triggering alarms or other actions when abnormal sound events occur within the monitored area.

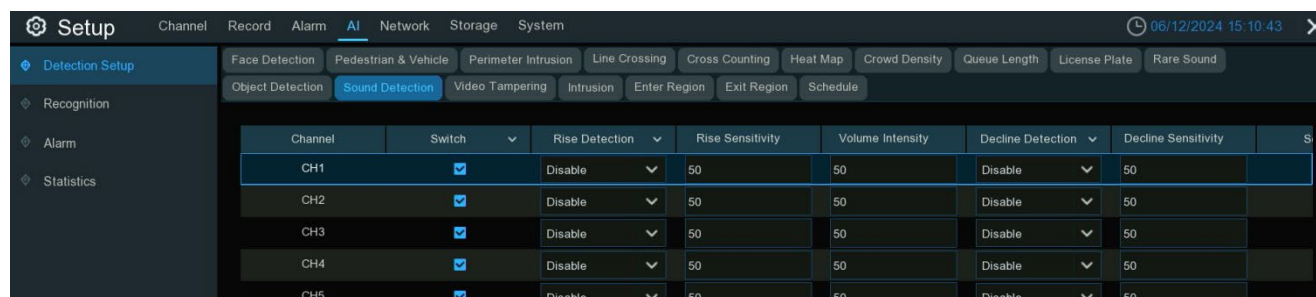

Switch: Enable or disable the Sound Detection feature.

Rise Detection: Enable or disable detection of increasing sound levels

Rise Sensitivity: Set the sensitivity for triggering sound rise detection from 1-100. A higher value increases the sensitivity to detect rising sound levels.

Volume Intensity: Set the intensity level from 1-100 for the triggered sound alarm. Higher values correspond to louder alarm volumes.

Decline Detection: Enable or disable detection of decreasing sound levels.

Decline Sensitivity: Set the sensitivity for triggering sound decline detection from 1-100. A higher value increases the sensitivity to detect decreasing sound levels.

Schedule: Set the time schedule for the Sound Detection feature. By default, it is enabled for all times, but you can customize the time periods when sound alarms should be active. Click or drag the mouse on the schedule to select the time slots. The blue sections indicate the periods during which the sound detection will be activated if a qualifying alarm occurs.

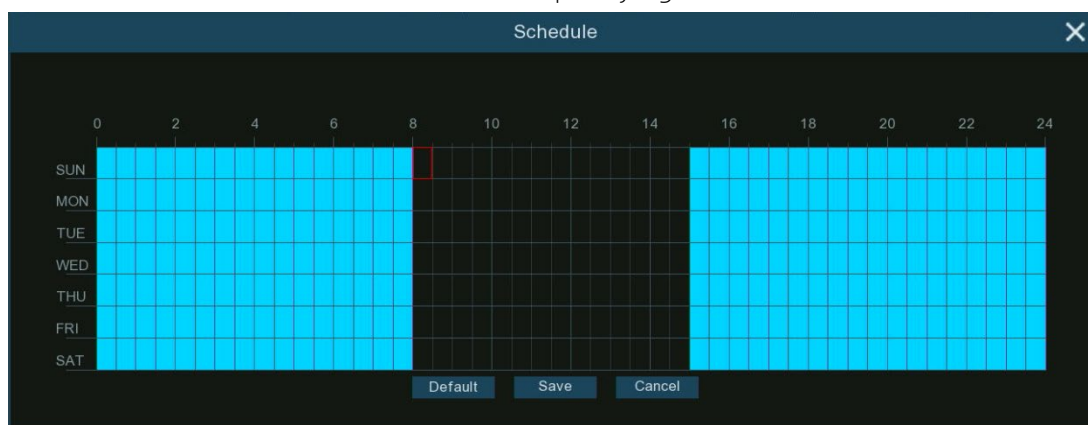

Click the **"Alarm"** button to configure the sound alarm function.

5.4.1.13 Video Tampering Detection

The Video Tampering detection can identify if a camera's image is obstructed or blocked, such as by covered lenses or physically tampering with the camera. This feature helps ensure continuous monitoring and alerts personnel if a camera's view is compromised, allowing timely response to prevent security breaches or investigate the cause of obstruction. Whether this feature is supported depends on the camera model being used.

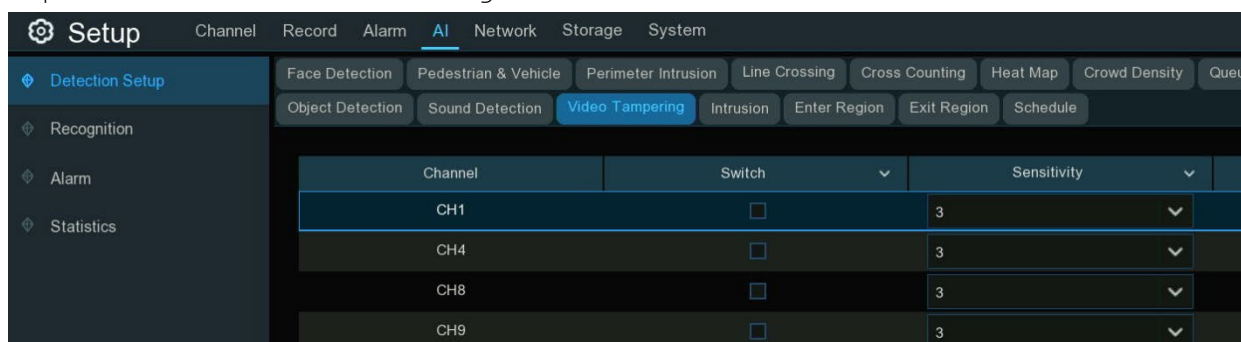

Switch: Enable or disable the Video Tampering detection function.

Sensitivity: Sensitivity levels range from 1 to 6, with a default value of 4. Higher sensitivity levels make it easier to trigger an alarm.

Click the **"Alarm"** button to configure the Video Tampering function.

5.4.1.14 Intrusion Detection

Intrusion detection can detect whether there is an object invading the set restricted area in the video. This feature is useful for monitoring restricted areas and detecting unauthorized entry or trespassing activities. It helps enhance security and surveillance in locations such as warehouses, construction sites, or other restricted premises. Whether this feature is supported depends on the camera model being used.

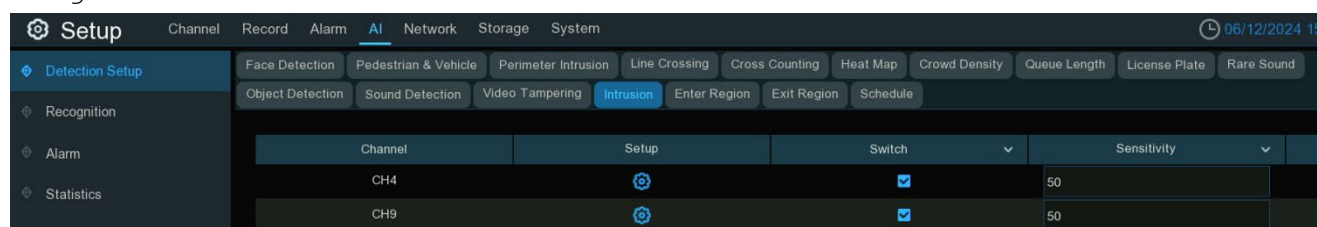

Switch: Enable or disable the Intrusion detection function.

Sensitivity: Sensitivity levels range from 1 to 100. Higher sensitivity levels make it easier to trigger an alarm.

Setup: Click to configure the detection conditions.

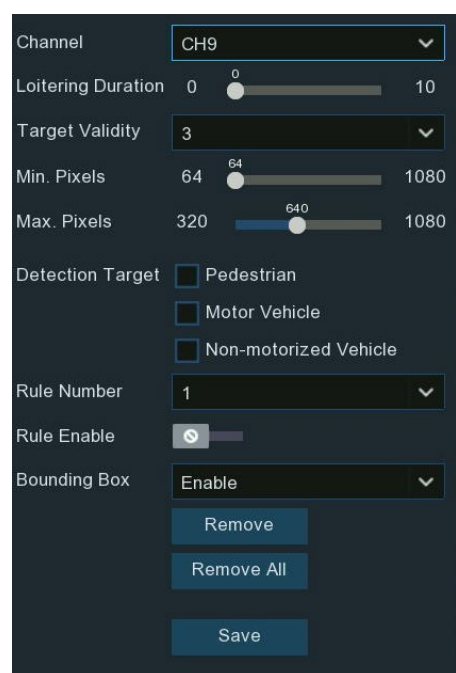

Channel: Select an available to configure.

Loitering Duration: It indicates the time duration (in seconds) an object must remain in the alert area before triggering an alarm. For example, if set to 5, the alarm will trigger immediately after the target has invaded the area for 5 seconds. The maximum duration can be set up to 10 seconds.

Target Validity: The similarity between the detected target and the set detection type. An alarm is triggered only when the set similarity level is reached or exceeded. Higher setting levels require greater similarity to the desired target characteristics, increasing alarm accuracy. Levels can be set from 1 to 4. 1 represents 80%+ similarity, 2 represents 60%+, 3 represents 40%+, 4 represents 20%+.

Min./Max. Pixels: Set the minimum and maximum pixel sizes for detected targets to be recognized.

Detection Target: Set the target type that needs to be detected:

- **Pedestrian:** Only detect intruding pedestrians
- **Motor Vehicle:** Only detect intruding motorized vehicles
- **Non-Motorized:** Only detect intruding non-motorized vehicles
- **No Target Type Selected:** All moving targets will be detected.

Bounding Box: When on, the target detection box is displayed in the live screen.

The method for setting the detection area is as follows:

1. Select an area number from [Rule Number](#).
2. Toggle the [Rule Enable](#) switch to turn it on.
3. In the preview screen, use your mouse to click eight points on the camera image to draw an octagonal. The area inside the octagonal is the detection area.
4. If you need to adjust the drawn area, click the box next to the area number. The box lines will turn red. Click any corner box and drag to adjust the size. You can also click any edge and drag to move the entire quadrilateral.

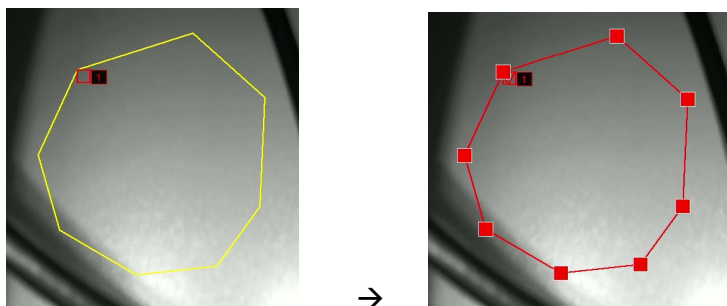

5. After making adjustments, click the [Save](#) button to save the changes.
6. If you need to delete a specific area, click the box next to the area number you want to delete in the preview screen, then click [Remove](#) to delete it. You can also click [Remove All](#) to delete all set areas.
7. After deleting, click the [Save](#) button to save the changes.

5.4.1.15 Enter Region

The Enter Region detection function can detect whether an object enters the set warning area and link the alarm according to the judgment result. This feature functions similarly to the Intrusion Detection feature and is applicable to different camera models depending on the camera's capabilities.

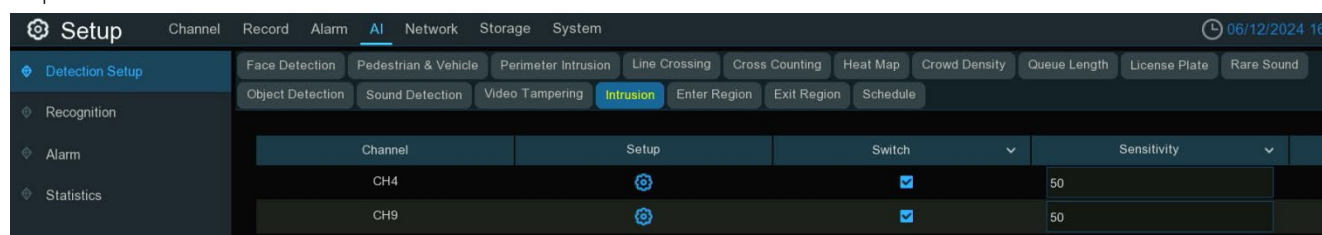

Switch: Enable or disable the Enter Region detection function.

Sensitivity: Sensitivity levels range from 1 to 100. Higher sensitivity levels make it easier to trigger an alarm.

Setup: Click to configure the detection conditions.

Channel: Select an available to configure.

Loitering Duration: It indicates the time duration (in seconds) an object must remain in the alert area before triggering an alarm. For example, if set to 5, the alarm will trigger immediately after the target has invaded the area for 5 seconds. The maximum duration can be set up to 10 seconds.

Target Validity: The similarity between the detected target and the set detection type. An alarm is triggered only when the set similarity level is reached or exceeded. Higher setting levels require greater similarity to the desired target characteristics, increasing alarm accuracy. Levels can be set from 1 to 4. 1 represents 80%+ similarity, 2 represents 60%+, 3 represents 40%+, 4 represents 20%+.

Min./Max. Pixels: Set the minimum and maximum pixel sizes

for detected targets to be recognized.

Detection Target: Set the target type that needs to be detected:

- **Pedestrian:** Only detect intruding pedestrians
- **Motor Vehicle:** Only detect intruding motorized vehicles
- **Non-Motorized:** Only detect intruding non-motorized vehicles
- **No Target Type Selected:** All moving targets will be detected.

Bounding Box: When on, the target detection box is displayed in the live screen.

The method for setting the detection area is as follows:

1. Select an area number from **Rule Number**.
2. Toggle the **Rule Enable** switch to turn it on.
3. In the preview screen, use your mouse to click eight points on the camera image to draw a octagonal. The area inside the octagonal is the detection area.
4. If you need to adjust the drawn area, click the box next to the area number. The box lines will turn red. Click any corner box and drag to adjust the size. You can also click any edge and drag to move the entire quadrilateral.

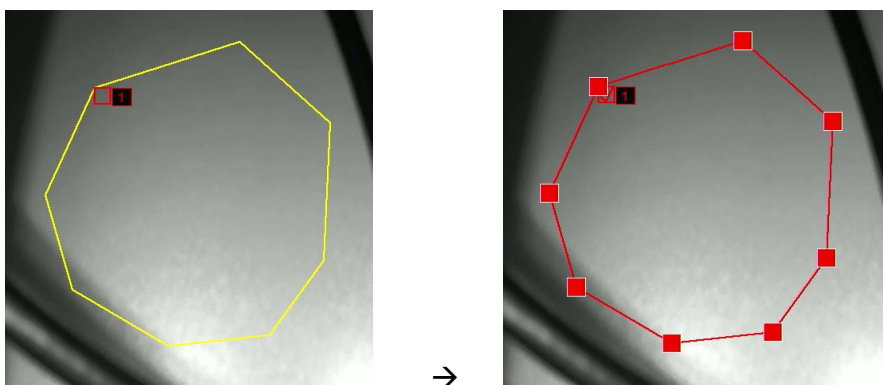

5. After making adjustments, click the **Save** button to save the changes.
6. If you need to delete a specific area, click the box next to the area number you want to delete in the preview screen, then click **Remove** to delete it. You can also click **Remove All** to delete all set areas.
7. After deleting, click the **Save** button to save the changes.

5.4.1.16 Exit Region

In contrast to the Enter Region feature, the Exit Region feature is used to detect when an object leaves a predefined monitoring area. This functionality is crucial for security purposes, as it helps to monitor and record instances where objects or individuals exit a specific zone, thereby ensuring comprehensive surveillance and control over the designated area.

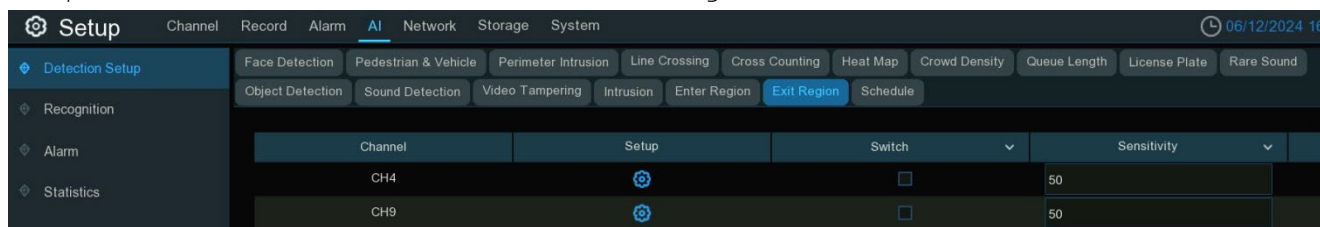

Switch: Enable or disable the Exit Region detection function.

Sensitivity: Sensitivity levels range from 1 to 100. Higher sensitivity levels make it easier to trigger an alarm.

Setup: Click to configure the detection conditions.

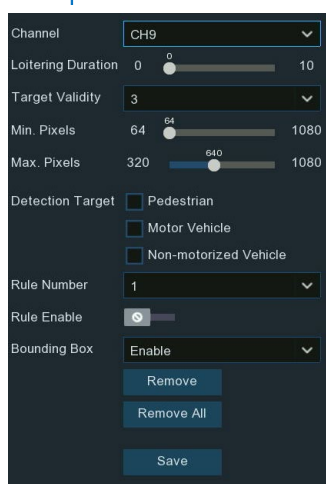

Channel: Select an available to configure.

Loitering Duration: It indicates the time duration (in seconds) an object must remain in the alert area before triggering an alarm. For example, if set to 5, the alarm will trigger immediately after the target has invaded the area for 5 seconds. The maximum duration can be set up to 10 seconds.

Target Validity: The similarity between the detected target and the set detection type. An alarm is triggered only when the set similarity level is reached or exceeded. Higher setting levels require greater similarity to the desired target characteristics, increasing alarm accuracy. Levels can be set from 1 to 4. 1 represents 80%+ similarity, 2 represents 60%+, 3 represents 40%+, 4 represents 20%+.

Min./Max. Pixels: Set the minimum and maximum pixel sizes for detected targets to be recognized.

Detection Target: Set the target type that needs to be detected:

- **Pedestrian:** Only detect intruding pedestrians
- **Motor Vehicle:** Only detect intruding motorized vehicles
- **Non-Motorized:** Only detect intruding non-motorized vehicles
- **No Target Type Selected:** All moving targets will be detected.

Bounding Box: When on, the target detection box is displayed in the live screen.

The method for setting the detection area is as follows:

1. Select an area number from **Rule Number**.
2. Toggle the **Rule Enable** switch to turn it on.
3. In the preview screen, use your mouse to click eight points on the camera image to draw a octagonal. The area inside the octagonal is the detection area.
4. If you need to adjust the drawn area, click the box next to the area number. The box lines will turn red. Click any corner box and drag to adjust the size. You can also click any edge and drag to move the entire quadrilateral.

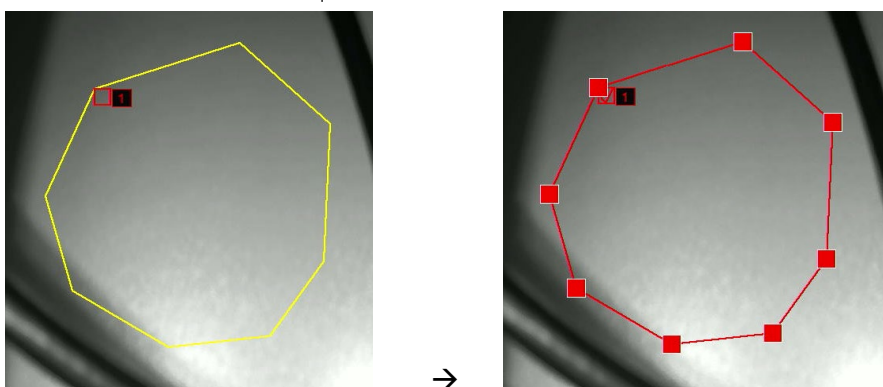

5. After making adjustments, click the **Save** button to save the changes.
6. If you need to delete a specific area, click the box next to the area number you want to delete in the preview screen, then click **Remove** to delete it. You can also click **Remove All** to delete all set areas.
7. After deleting, click the **Save** button to save the changes.

5.4.1.17 Fire Detection

If there is a thermal imaging camera connected to your NVR, the Fire Detection functionality becomes available. This menu allows for the configuration of settings related to fire detection. By utilizing thermal imaging technology, the system can identify temperature anomalies indicative of fire outbreaks. This feature plays a crucial role in early fire detection, enabling prompt response measures to mitigate potential hazards and minimize damage.

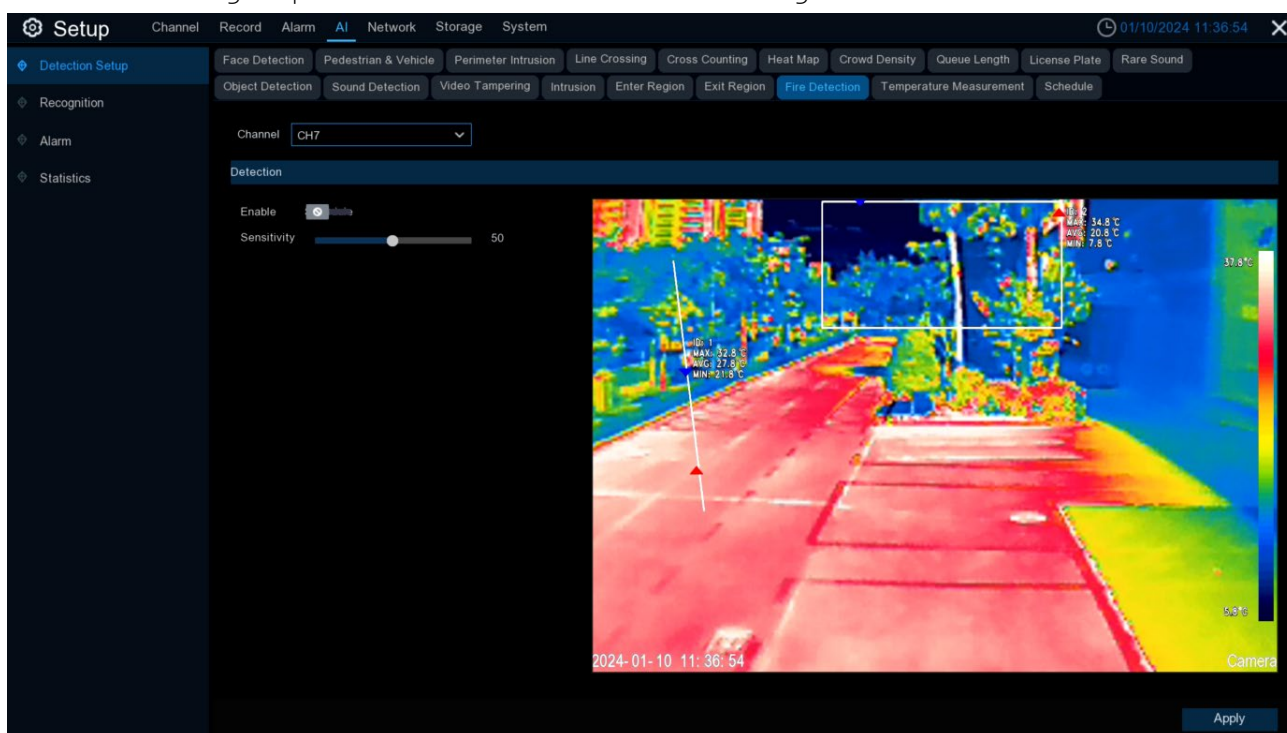

Enable: Enable or disable fire detection.

Sensitivity: Adjust the sensitivity of the fire detection. Lower sensitivity means a higher temperature is required to trigger the fire detection alarm. Higher sensitivity means the alarm will be triggered at a lower temperature.

5.4.1.18 Temperature Measurement

If there is a thermal imaging camera connected to your NVR, the Fire Detection functionality becomes available. Used for real-time temperature monitoring of the monitoring area. When the temperature exceeds the alarm threshold, it triggers an alarm and executes the linkage action. By setting alarm rules, temperature thresholds, and other parameters, the system will automatically analyze the data collected by the thermal imaging camera and trigger alarms in a timely manner. This allows you to stay on top of temperature information at all times and respond quickly to various abnormal situations, thereby improving safety and operational efficiency.

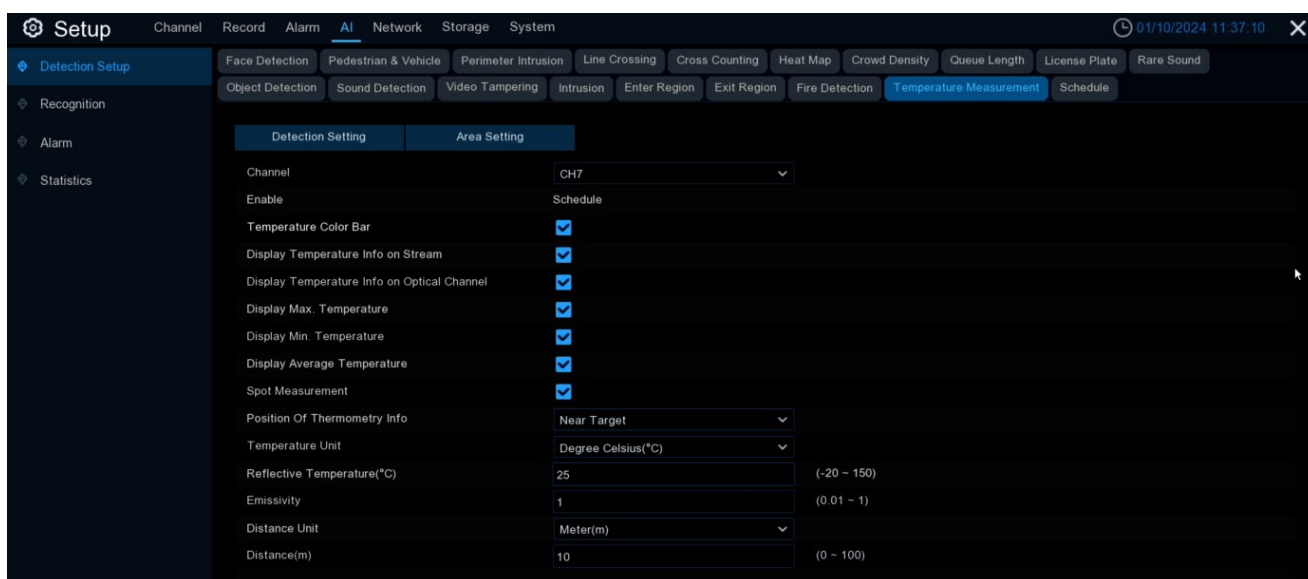

- **Temperature Measurement Detection Settings**

Enable: Enable/disable the temperature measurement function.

Temperature Color Bar: When enabled, a color bar representing different temperature ranges is displayed on the right side of the thermal imaging channel preview, along with the max and min temperatures.

Display Temperature Info On Stream: When enabled, it overlays the temperature measurement area and monitored temperature on the thermal channel preview.

Display Temperature Info On Optical Channel: When enabled, it synchronizes and displays the temperature measurement area and monitored temperature on the optical channel preview as well.

Display Max. Temperature: When enabled, it shows the maximum monitored temperature on the preview screen. Requires first turning on display of temperature info.

Display Min. Temperature: When enabled, it shows the minimum monitored temperature on the preview screen. Requires first turning on display of temperature info.

Display Average Temperature: When enabled, it displays the average monitored temperature on the preview screen. Requires first turning on display of temperature info.

Note: For a point-based temperature rule, it will only display the average temperature at that point. Maximum and minimum will not be shown.

Spot Measurement: When enabled, allows clicking any area in the thermal imaging preview to perform a single-point temperature reading.

Position of Thermometry Info: Lets you set the position for displaying temperature information on the preview screen.

Near Target: Temperature info is shown next to each respective monitoring area.

Top Left: All temperature info is displayed in the top left corner.

Temperature Unit: Sets the unit for displaying temperatures - Celsius, Fahrenheit or Kelvin.

Reflective Temperature: Sets the ambient temperature of the camera's environment.

Note: Reflected temperature refers to the ambient temperature reflected off the surface of the object being measured. Thermal radiation reflected off an object's surface is affected by the ambient temperature. The reflected temperature is the temperature of this reflected thermal radiation. Setting the reflected temperature helps the thermal camera accurately measure the object's surface temperature. In thermal imaging, the infrared radiation received by the camera includes emission from the object itself as well as reflected environmental radiation. By accounting for the ambient reflected temperature, the object's surface temperature can be isolated and calculated accurately.

Emissivity: Each material target has a corresponding emissivity value, which is a measure of its infrared emission ability ranging from rough to smooth surfaces. Set the appropriate emissivity value according to the type of target being measured for temperature. (Refer to the table of common substance emissivities).

Substance	Emissivity
Human skin	0.98
Cotton fabric	0.98
Water	0.96
Asphalt	0.96
Concrete	0.95
Brick	0.95
Rubber	0.95
Paint	0.93
Ceramics	0.92
Soil	0.92
Printed circuit board	0.91
Paper	0.90
Cardboard	0.90
Sand	0.90
Wood	0.85

Emissivity table for common substances

Note: Emissivity is the ability of an object's surface to emit infrared radiation. It affects the accuracy of the thermal camera in measuring the object's true surface temperature. Different materials have

varying emissivity levels, leading to different degrees of infrared reflection and absorption, which can cause deviations in temperature measurement if not accounted for.

Distance Unit: Options for meters or inches.

Distance: Indicates the straight-line distance between the target being measured and the device's location, which should be set according to the actual setup.

● Temperature Measurement Area Setup

The screenshot displays the 'Setup' interface for 'Temperature Measurement'. The 'AI' tab is active, and the 'Temperature Measurement' sub-tab is selected. The 'Channel' is set to 'CH7'. The interface is divided into 'Detection Setting' and 'Area Setting' sections. The 'Area Setting' section contains a table with the following data:

ID	Enable	Name	Rules	Emissivity	Distance	Reflective Temperature	Setup
1	<input checked="" type="checkbox"/>	1	Line	0.98	1	25	
2	<input checked="" type="checkbox"/>	2	Area	0.98	1	25	
3	<input checked="" type="checkbox"/>	3	Point	0.98	1	25	
4	<input checked="" type="checkbox"/>	4	Point	0.98	1	25	

Below the table are 'Add' and 'Delete' buttons. To the right is a thermal camera preview showing a street scene with a red line and a point marker overlaid. The preview includes temperature data: Max: 34.4°C, Avg: 28.5°C, Min: 7.8°C. At the bottom right of the preview is a 'Delete' button. At the bottom right of the entire interface is an 'Apply' button.

Click "Add" to define a new temperature measurement rule. Maximum of 20 rules allowed.

Check any rule and click "Delete" to remove it.

Enable: Select a rule and enable it.

Name: Customize a name for the rule.

Rules: Select the type of temperature rule - point, line or area:

- **Point:** Click anywhere on the right preview to set a point-based temperature measurement rule. The preview will show the rule marker and average temperature at that point.
- **Line:** Click anywhere on the right configuration screen. Hold down the mouse and drag to another location to draw a line-based temperature measurement rule. This indicates that the temperature will be measured at locations along that line. Click on the checkbox of the rule line to adjust its length, angle, and position. The preview screen will show the rule line and temperature information at points along that line segment.

- **Area:** Click and drag on the right preview to draw a quadrilateral area-based temperature measurement rule. This indicates the entire area will be monitored for temperature. Click the rule's checkbox to resize and reposition the area. The preview displays the rule and temperature information for that entire region.

Emissivity: Set the appropriate emissivity value for the target being measured.

Distance: Set the straight-line distance between the target and the device's location.

Reflective Temperature: Set the ambient temperature of the camera environment.

Reflective Temperature: Set the ambient temperature of the camera.

Setup: Click setup button  to enter the Alarm Rule Setup page and configure alarm parameters for each temperature measurement rule.



Alarm Rules: Several alarm rule conditions are available:

- Above(Max.Temperature)
- Below(Max.Temperature)
- Above(Min.Temperature)
- Below(Min.Temperature)
- Above(Average.Temperature)
- Below(Average.Temperature)
- Above(Temperature Difference)
- Below(Temperature Difference)

For a Point-based temperature rule, the only applicable rules are:

- Above(Average.Temperature)
- Below(Average.Temperature)

Alarm Temperature: Set the temperature threshold that will trigger the alarm.

Alarm Temperature: Set the temperature threshold that will trigger the alarm.

Duration Time: The duration for which the measured temperature must continuously exceed the alarm threshold before triggering the alarm.

Tolerance Temperature: Allows setting a temperature tolerance range to prevent rapidly fluctuating temperatures from triggering/clearing the alarm repeatedly.

For example, if the alarm rule is "Above(Average.Temperature)", the Alarm Temperature is set to 40°C, the Duration Time is set to 3 seconds, and the Tolerance Temperature is set to 3°C, then the alarm will be triggered when the average monitored temperature exceeds 40°C continuously for more than 3 seconds. The alarm will be canceled only when the average monitored temperature drops to 37°C or below.

5.4.1.19 Schedule

The Schedule menu is designed to set the activation times for AI-related detection features. The schedule allows users to define specific time intervals during which various AI-based detection functions are active. By configuring schedules, users can optimize resource allocation, reduce false alarms during off-peak hours, and ensure that detection capabilities are aligned with operational needs and security requirements.

When the camera is connected to the NVR with camera's [Media/Client](#) port, the setup page is shown below:

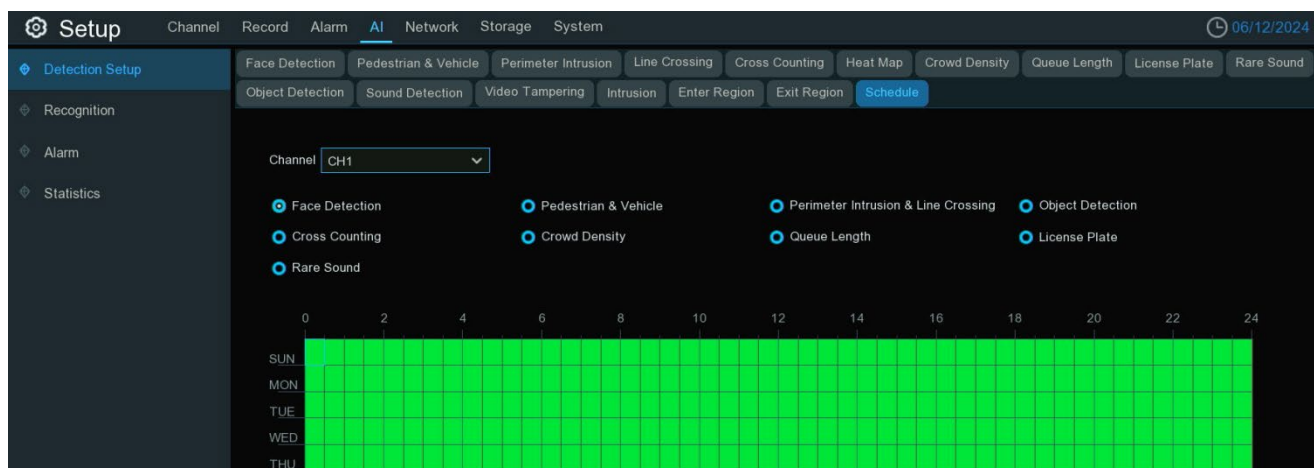

1. Click on the radio button of the detection type you want to set.
2. Click or drag the mouse on the schedule to select the time slots. The green sections indicate the periods during which the detection will be activated if the selected event occurs.
3. Click the **Apply** button to activate the schedule.
4. The schedule is valid only for the selected channel each time when you set. If you want to use the same schedule for other channels, use **Copy** function.

When the camera is connected to the NVR with camera's [http](#) port, the setup page is shown below:

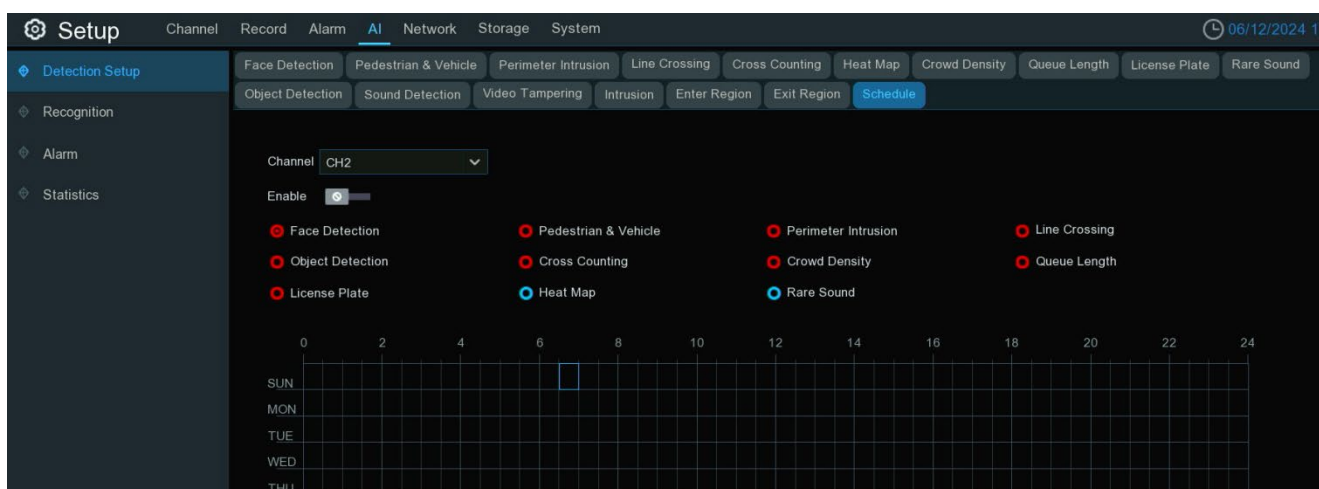

1. Click on the radio button of the event you want to set.
2. Click or drag the mouse on the schedule to select the time slots. The blue sections indicate the periods during which the warning lights will be activated if the selected alarm occurs.
3. Click the Switch to activate the schedule.
4. Select the channel you want to configure.
5. Click "Enable" to activate the Schedule setting for AI functions on this channel. Once enabled, all AI functions for this channel will be controlled by the schedule. Individual toggles for AI functions on relevant detection pages will be disabled, and instead, the "Schedule" will be displayed.

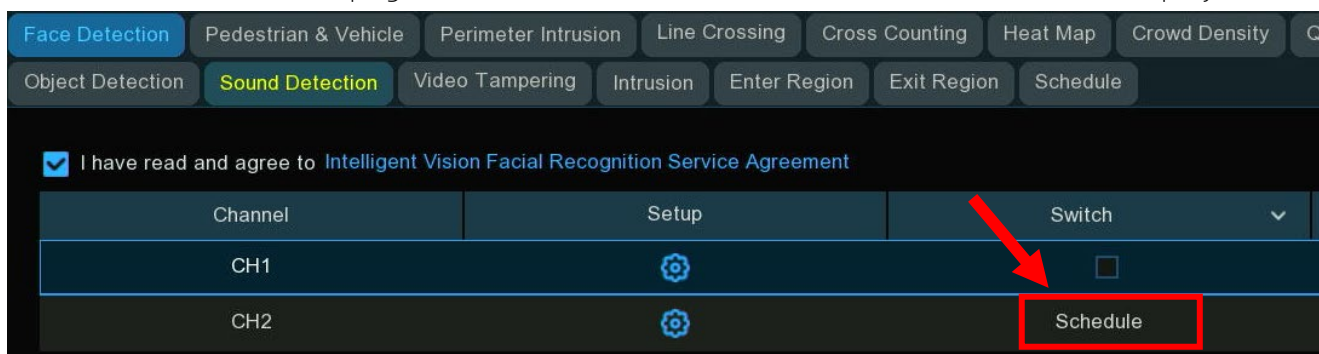

6. The page lists all available AI detection functions for this channel. Detection types marked with a red circle indicate exclusivity, meaning that one or more detection types within the same time period cannot be enabled simultaneously.
7. Click on any detection type you wish to configure, then use the mouse to click or drag on the schedule to select the time. Green cells indicate that the AI detection function will be active during the corresponding time period.
8. Click on another detection type you wish to configure. You may notice that some cells on the schedule appear grayed out and cannot be selected. This indicates that the currently selected detection type conflicts with previously set schedules for other detection types. You can only select available time slots shown in black.



9. Once your settings are complete, click the "Apply" button to save them.

5.4.2 AI Recognition

AI Recognition primarily serves to allow users to configure and manage the artificial intelligence algorithm models used for video analytics, as well as the related face and license plate databases, so that recognized faces and license plates can be categorized and managed.

5.4.2.1 Model Configuration

This menu is mainly used to configure the AI algorithm models required for AI recognition, as well as to manage the face databases and license plate databases needed for face recognition and license plate recognition, respectively. There are local model and IP Camera models (some devices do not have a local algorithm model and need to be connected to an IP Camera with an algorithm model to use the corresponding functions).

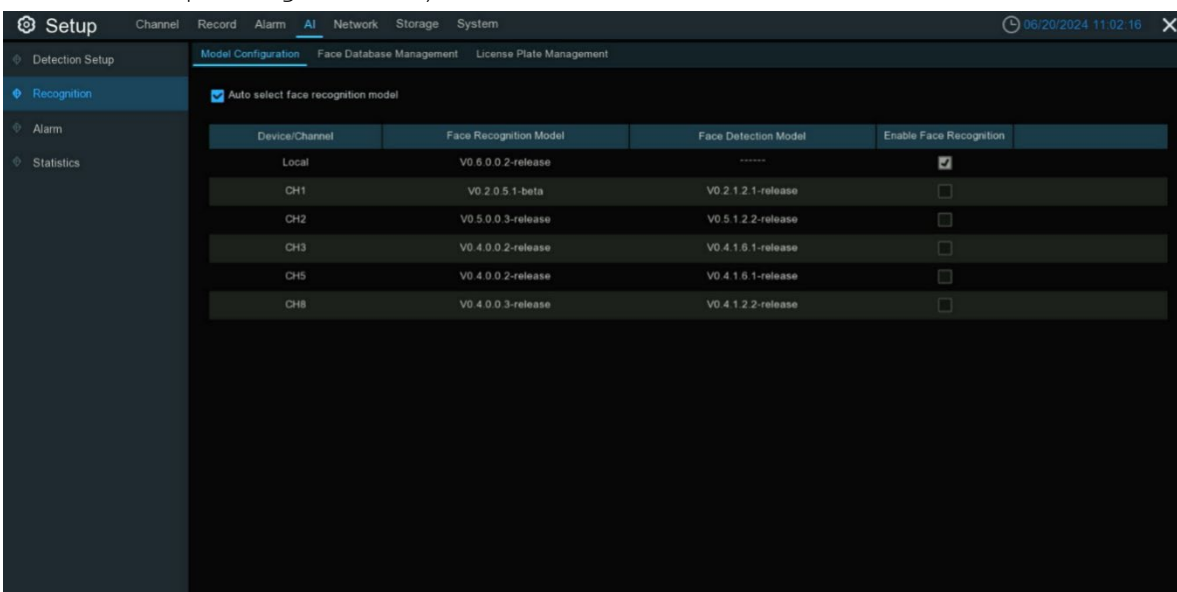

The face AI algorithm mainly includes two parts: Detection and Recognition.

- Detection is mostly used to detect and capture face images. Generally, the detection capability is provided by IP cameras.
- Recognition is mostly used to extract, analyze and compare facial features. Recognition capability is typically provided by the NVR and IP cameras equipped with recognition algorithms.

If you want to use the face recognition function in your NVR, at least one face recognition algorithm model must be enabled. The recognition algorithm model can be chosen from Local (NVR) or Channel (if the camera has recognition capability).

"[Auto select recognition model](#)" is recommended, the system will automatically select the optimal algorithm model source.

Uncheck the "[Auto select recognition model](#)" checkbox, and you can manually choose the model.

When you manually select the model, you need to follow these principles:

1. Between NVR and camera, you can only choose either one.
2. Among different model versions in cameras, only models with the same version can be selected.
3. More than one model with the same version can be enabled.
4. If you manually change the algorithm model, the system may send you a notice, or you will find an "Update facial features" button in the Database Management menu. Click OK or the "Update facial features" button to update the database.

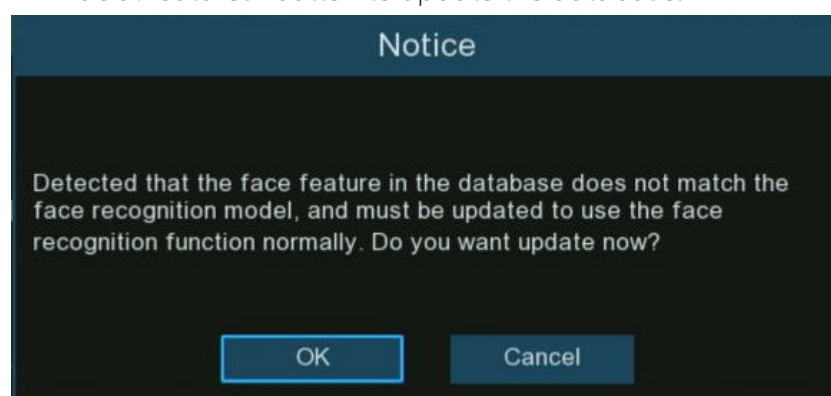

5.4.2.2 Face Recognition Database Management

You're able to create and manage face profiles (databases) to classify different people into different groups in order to quickly identify individuals remotely and enable intelligent alarms in advance.



There are 3 default groups:

- **Allow List:** Mostly used to define a list of people regarded as acceptable or trustworthy, such as family members, colleagues, frequent customers, etc.
- **Block List:** Mostly used to define a list of people regarded as unacceptable or untrustworthy and who should be excluded or avoided.
- **Stranger:** All ungrouped people will be identified as strangers.

You can click the add button to create or the delete button to remove the customized groups.

If you want to make a backup of your database, use the "**Backup Database**" function to export it to your USB flash drive. The exported database can be imported to the same or another NVR by using the "**Import Database**" function (Please note, this will overwrite existing settings and face profiles). Tick the "**Enable**" checkbox to enable the group. You will need to create face profiles (add face images) to the groups in order to fully utilize the identification capabilities.

5.4.2.2.1 Create Face Profiles from Local Storage Device

This section will show how to create face profiles from face images that have been captured and stored on your NVR.

1. Click the edit button of the group that you would like to create face profiles for.



2. From the Group window, click the "Import" button, then click the "Local Storage Device" button.

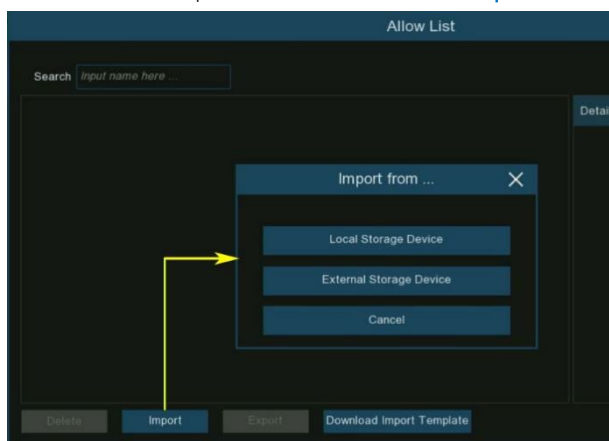

3. On the pop-up page, perform the following operations in order to select the face image(s):

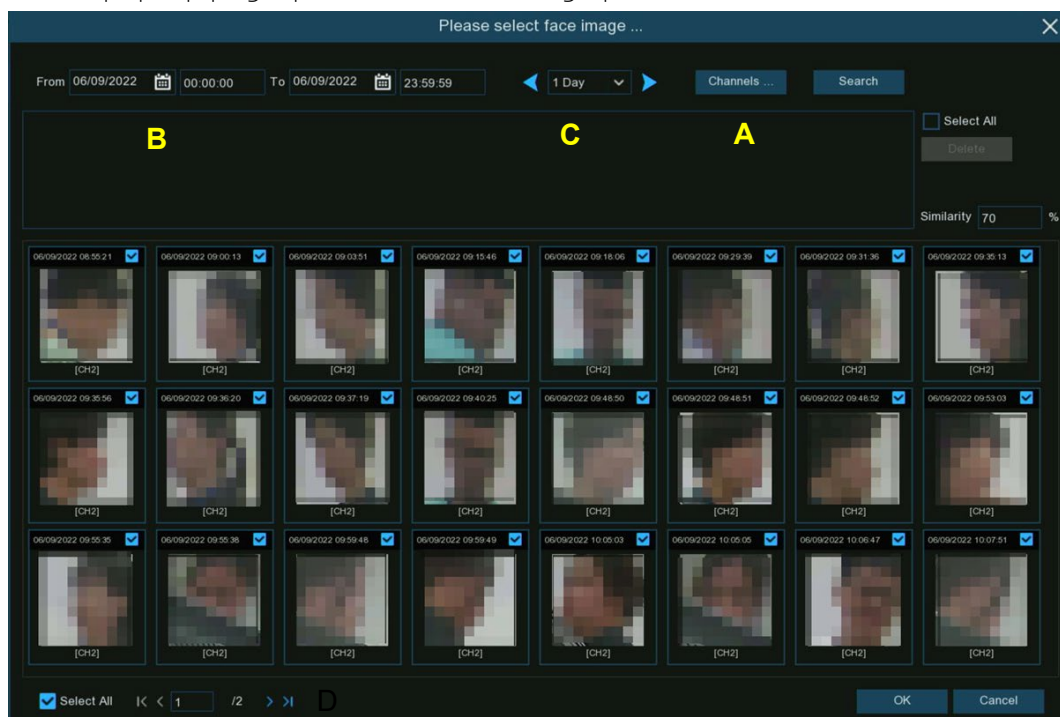

- First, select the channels you need to search on. All channels are set to search by default. You can specify the cameras you want to search on.
- Use the calendar to specify the date & time range.
- Choose the day duration, and then use the arrow buttons to quickly display face images from the previous or next day(s).
- All face images captured within the specified date range will be automatically displayed in the face list. Use the arrow buttons to display previous or next page of results.

4. Tick the checkbox to select individual face images, or tick "Select All" to select all face images in the current page of search results.

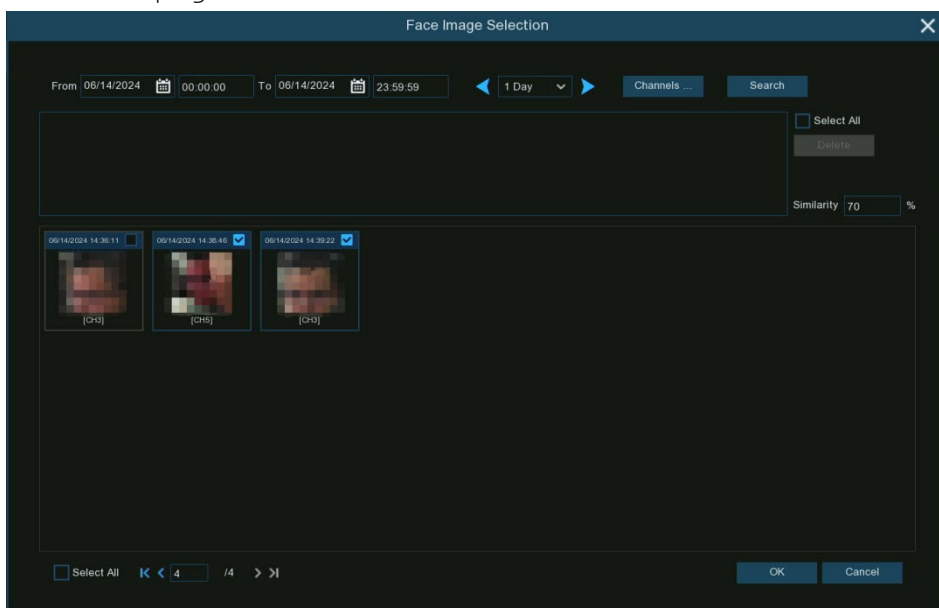

5. Once you've selected one or more face images, click the "OK" button. The system will go to the profile edit page. On the pop-up page, the left side displays the face images you just selected. You can click on any of the images on the left, and the corresponding information will appear on the right side. You can modify this information to complete the personal details.

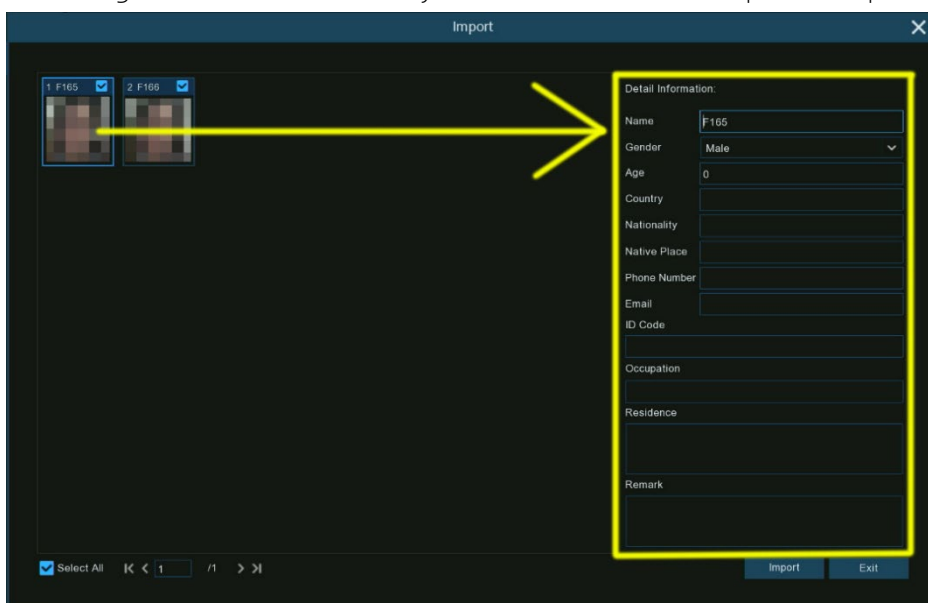

6. After completing the editing for all faces, click the "Import" button to import the face profiles into the database of the group.

5.4.2.2.2 Create Individual Face Profile from External Storage Device

- Copy the face images to your USB flash drive, and then insert the USB device into the USB port of the NVR.
- Note:** The supported image formats are .jpg, .jpeg, .png, and .bmp. The supported image dimensions are from 80x80 to 800x800 pixels, and the maximum file size is 500KB.

Name	Type	Size	Dimensions
Anna.jpeg ✓	JPEG File	32 KB	700 x 720
Jack.jpeg ✓	JPEG File	88 KB	800 x 683
David.jpg ✗	JPG File	168 KB	800 x 891
Jenny.jpeg ✗	JPEG File	82 KB	1000 x 1000
Selina.jpg ✗	JPG File	626 KB	800 x 683
Victoria.jpg ✗	JPG File	4,371 KB	6000 x 4000

- Click the edit button  of the group you would like to create face profiles for.



- From the Group window, click the "Import" button, then click the "External Storage Device" button.

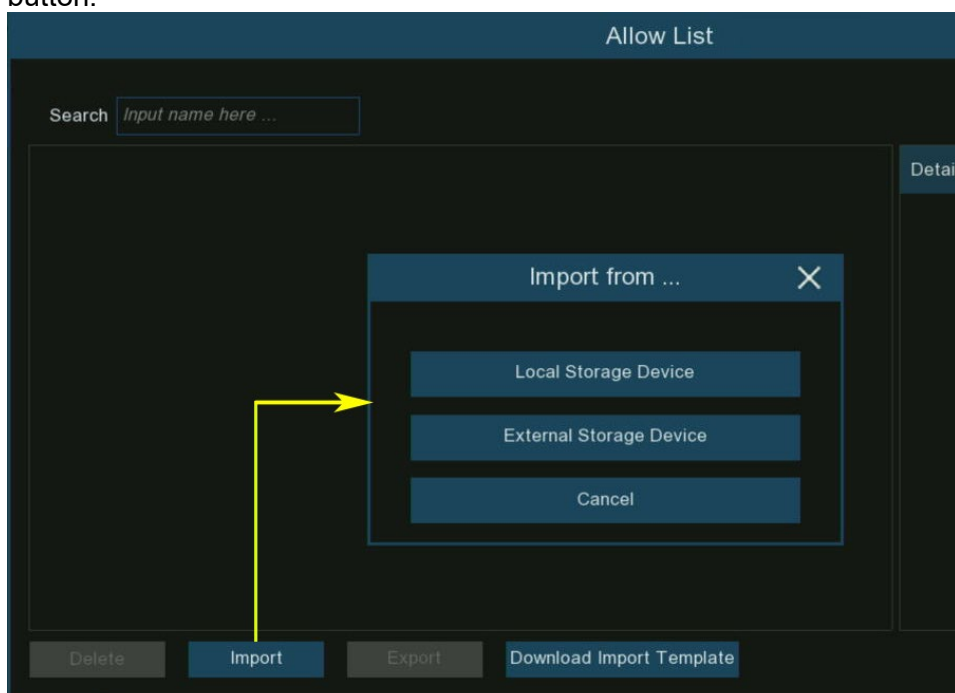

- Click on the face image you want to import, and then click the "OK" button.

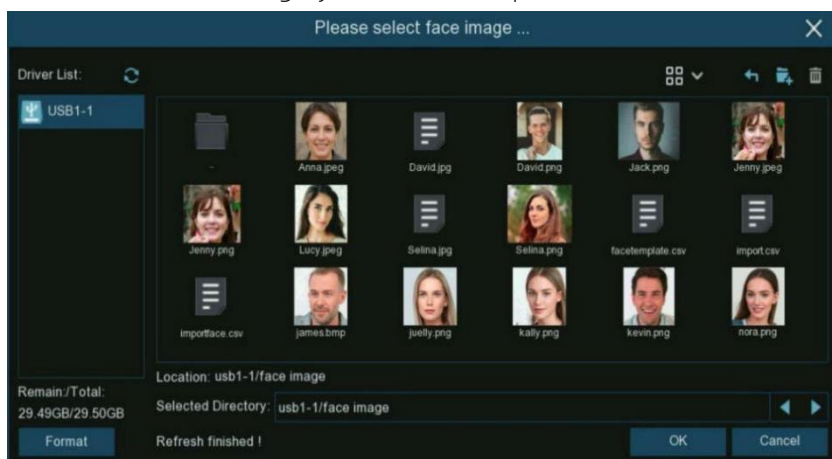

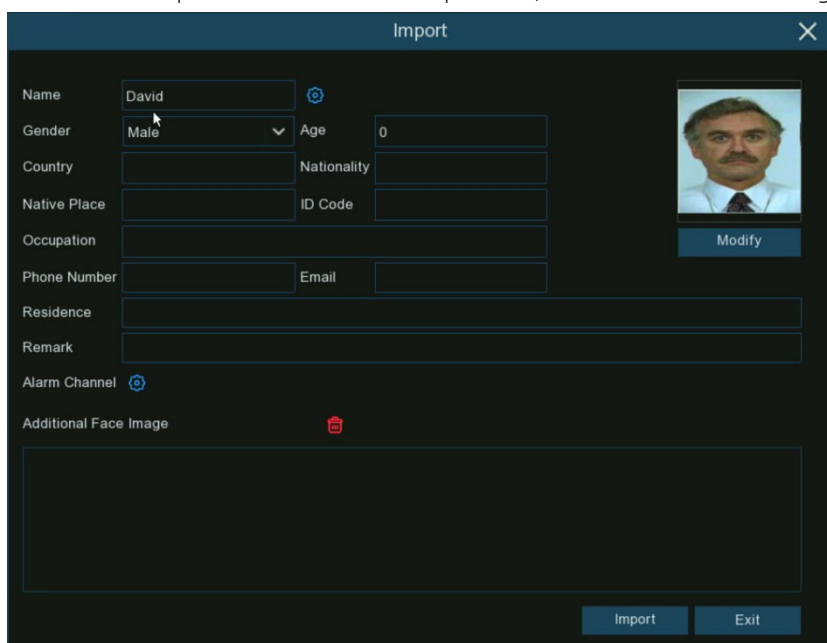

- Edit the face profile details of the person, such as name and age.



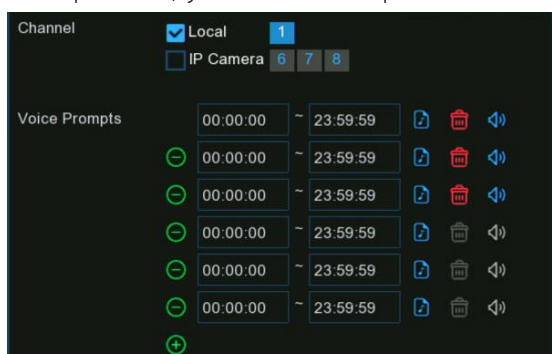

- Click the setup button  next to the "Name" field to configure the voice prompt for the person. See [Section 5.3.8. Voice Prompts](#) to learn how to set up this feature.
- Note: The voice file imported here applies only to this specific person. If you have set multiple time periods, you need to import a voice file for each period.

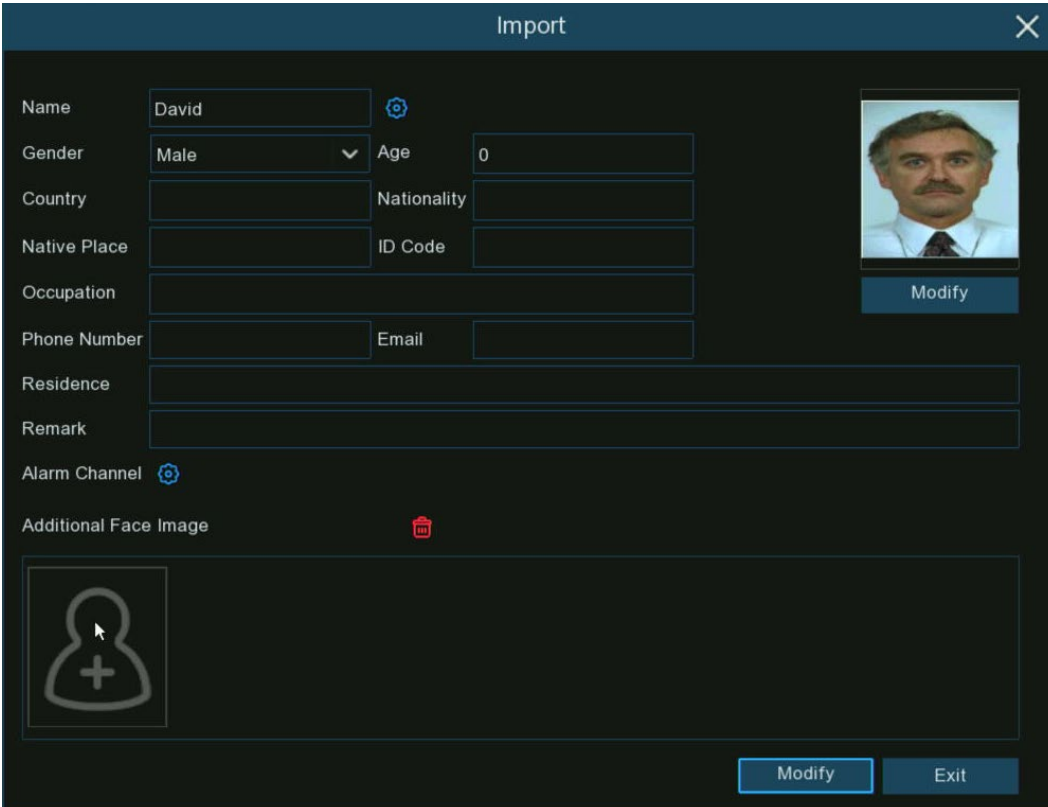

9. Click the setup button  next to "Alarm Channel" to configure the Alarm Channel. The system will trigger an alert when the face is detected and captured by the selected cameras.
10. Click the "Import" button to import the face profile.
11. You will now see an add button  in the Additional Face Image window. You can add additional face images at different angles for the same person to improve face recognition accuracy.



12. Click the add button  to add images from local and/or external storage devices. Maximum of 10 additional images allowed.
13. You can click the delete button  to remove the selected image.

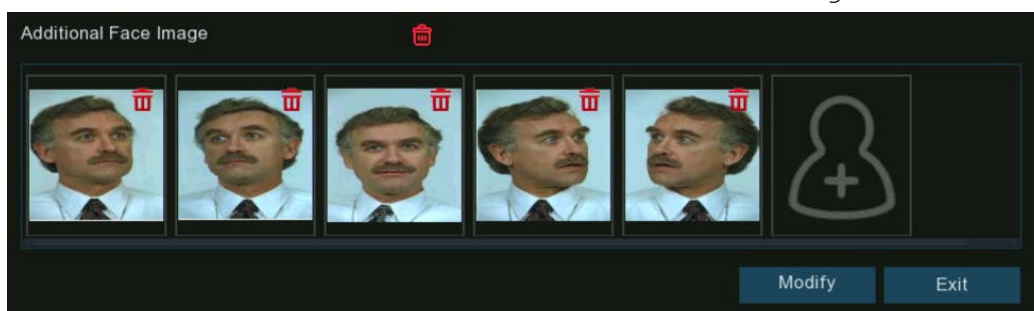

14. Click "Modify" when finished, then click "Exit" or right-click to exit.

5.4.2.2.3 Create Bulk Face Profiles from External Storage Device

If you want to create a batch of face profiles at once, please proceed as follows:

1. Click the "Edit" button of the group you would like to create face profiles for.



2. Insert your USB flash drive, and then click the "Download Import Template" button at the bottom of the page. A zip file named "import_template_enu.zip" will be downloaded onto your USB drive.

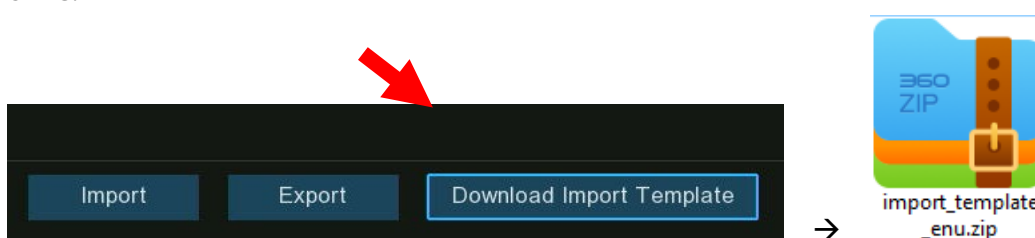

3. Unzip the file, you will get two files as shown.

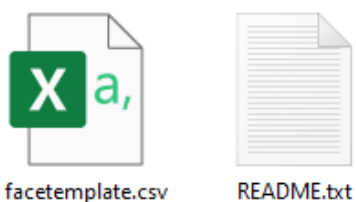

4. Create a new folder, and give it a name.

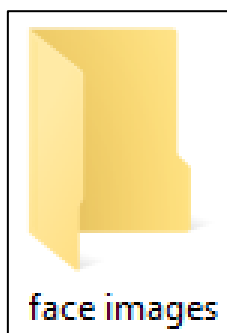

- Copy the extracted "facetable.csv" file and the previously prepared face images into this new folder. Ensure the image formats are .jpg, .jpeg, .png, or .bmp, with dimensions between 80x80 and 800x800 pixels, and file size no more than 500KB.

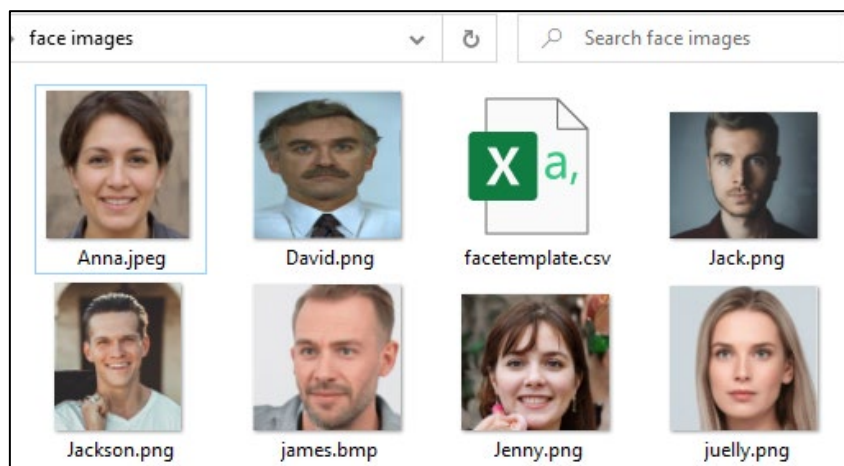

- Double click on the "facetable.csv" file to open it with Excel. The contents are shown below:

A	B	C	D	E	F	G	H	I	J	K	L	M	N	O	P
name	gender	age	image pat	country	nation	nativepos	idcode	occupaito	phone	email	domicile	remark			
xxxx	male	30	face/impc	China	Han natio	ZhuHai	20200903	zhuhai	1.46E+15	12348545	zhuhai	bukeyishuruzhongwen,bixuyongutf8			

- Column A: Name of the person
- Column B: Gender of the person
- Column C: Age of the person
- Column D: Complete filename of the image, e.g. "David.png"
- Column E: Country/region the person is from
- Column F: Race of the person
- Column G: Native place of the person
- Column H: ID number of the person
- Column I: Occupation/Job/Career of the person
- Column J: Phone number of the person
- Column K: Email address of the person
- Column L: Residence address of the person
- Column M: Remarks column

- Edit the cells according to your actual information as illustrated below:

name	gender	age	image path	country	nation	nativepos	idcode	occupaiton	phone	email	domicile	remark
Anna Joyce	Female	30	Anna.jpeg	UK	English	England	123456789	Professor	07-123 456 789	test@xxxxx.com	No. xx, Downing Street, London	Test
Nora Martins	Female	30	nora.png	UK	English	England	123456790	Professor	07-123 456 790	test@xxxxx.com	No. xx, Downing Street, London	Test
Shelly Clinton	Female	30	shelly.jpeg	UK	English	England	123456791	Editor	07-123 456 791	test@xxxxx.com	No. xx, Downing Street, London	Test
Sinna Donald	Female	30	sinna.png	UK	English	England	123456792	Photographer	07-123 456 792	test@xxxxx.com	No. xx, Downing Street, London	Test
James Timothy	Male	30	james.bmp	UK	English	England	123456793	Director	07-123 456 793	test@xxxxx.com	No. xx, Downing Street, London	Test
Juelly Smith	Female	30	juelly.png	UK	English	England	123456794	Cashier	07-123 456 794	test@xxxxx.com	No. xx, Downing Street, London	Test
Kally Jones	Female	30	kally.png	UK	English	England	123456795	Reporter	07-123 456 795	test@xxxxx.com	No. xx, Downing Street, London	Test
Kevin Williams	Male	30	kevin.png	UK	English	England	123456796	Manager	07-123 456 796	test@xxxxx.com	No. xx, Downing Street, London	Test
Jenny Brown	Female	30	Jenny.png	UK	English	England	123456797	Guide	07-123 456 797	test@xxxxx.com	No. xx, Downing Street, London	Test
Lucy Taylor	Female	30	Lucy.jpeg	UK	English	England	123456798	Operator	07-123 456 798	test@xxxxx.com	No. xx, Downing Street, London	Test
David Wilson	Male	30	David.png	UK	English	England	123456799	Scientist	07-123 456 799	test@xxxxx.com	No. xx, Downing Street, London	Test
Jack Davis	Male	30	Jack.png	UK	English	England	123456800	Professor	07-123 456 800	test@xxxxx.com	No. xx, Downing Street, London	Test
Selina Johnson	Female	30	Selina.png	UK	English	England	123456801	Composer	07-123 456 801	test@xxxxx.com	No. xx, Downing Street, London	Test

- Please **Note:** If you input an uninterrupted number more than 11 digits in a cell, the system will display it in scientific notation, e.g. "1.23457E+11". If so, you need to adjust the column format to "Text".



Select the column (especially ID code and phone number columns) and right-click. Click "Format Cells..." on the pop-up menu, and then choose "Text" and click "OK".

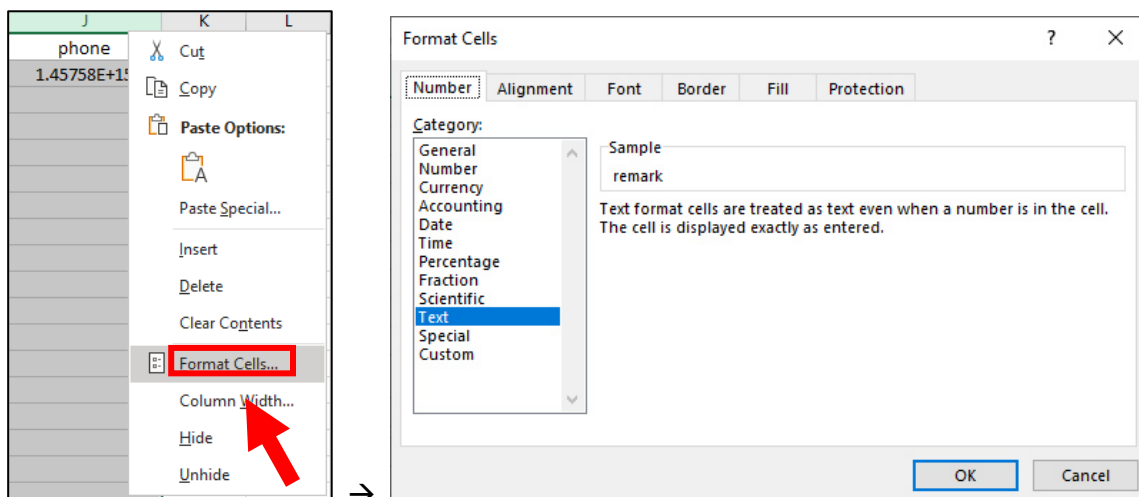

- Save the .csv file, ensuring it is saved as CSV UTF-8 type.
- Copy the whole folder, including the face images and "facetemplate.csv" file, and paste it onto your USB flash drive.
- Insert the USB drive into the USB port of your NVR.
- Click the edit button  of the group you want to create face profiles for.



- From the Group window, click "Import", then "External Storage Device".

14. Find and click on the "facemplate.csv" file from your USB drive, then click OK.

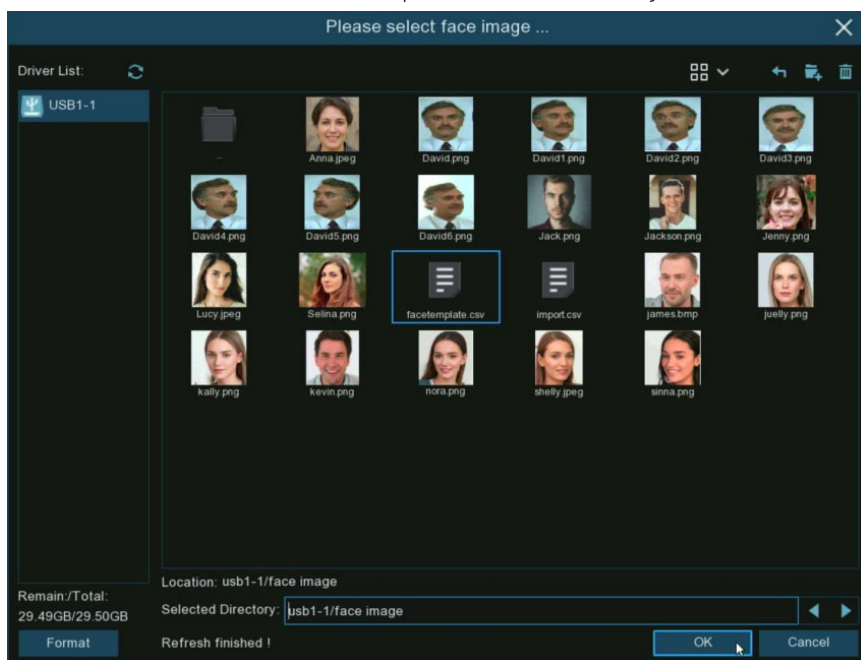

15. The face profiles are shown here. Click the Import button to import the face profiles into the NVR.

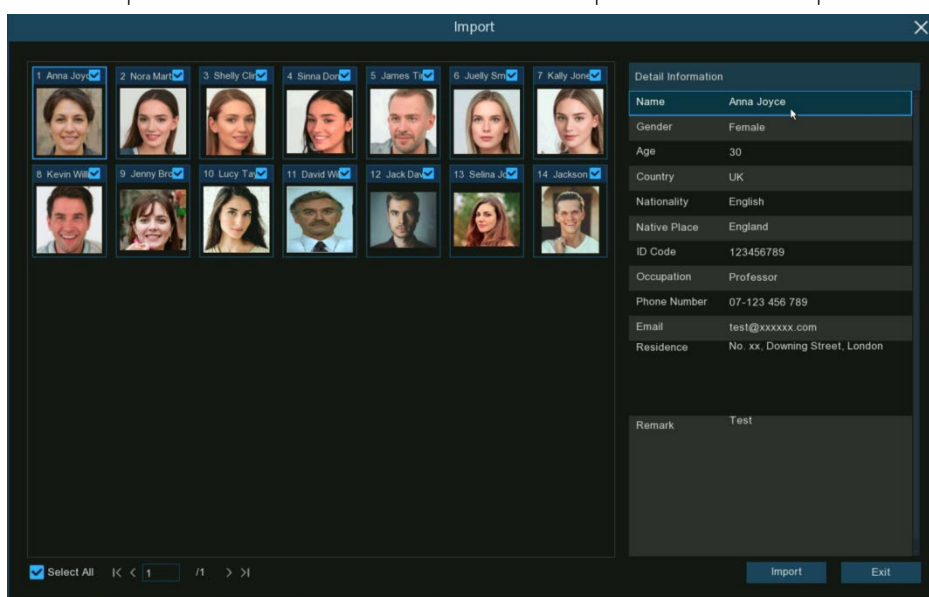

5.4.2.2.4 Edit Face Profiles

If you want to edit or delete a face profile, please proceed as follows:

1. Click on the edit button  of the group you want to edit.



2. In the group edit page, you're able to execute the following operations:

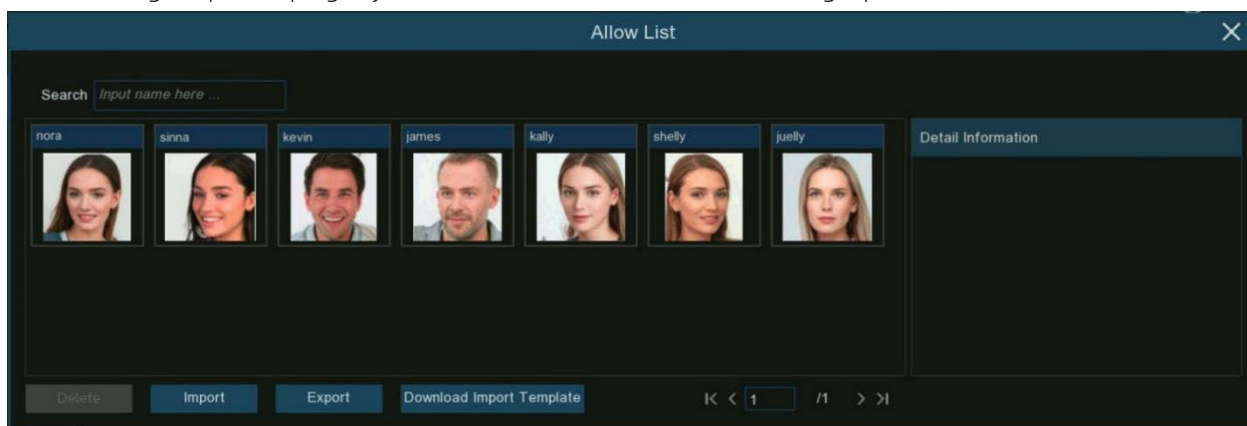

- **Import:** To import face images.
 - **Export:** To export face image(s) to external USB flash drive.
 - Click Export button directly to export all face images in this group.
 - Click on one of the face images, and then click Export button to export an individual image.
 - Click and hold the left mouse button, then drag the cursor to select multiple images, and then click Export button to export the selected images.
3. Move the mouse cursor over the image you want to edit and then click the left mouse button to select it. Click the right mouse button to display a pop-up menu.

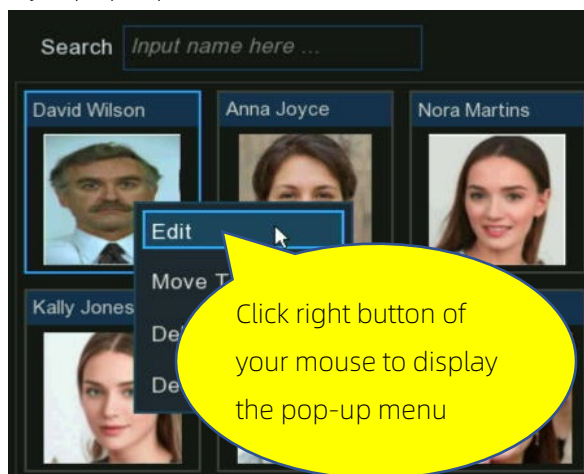
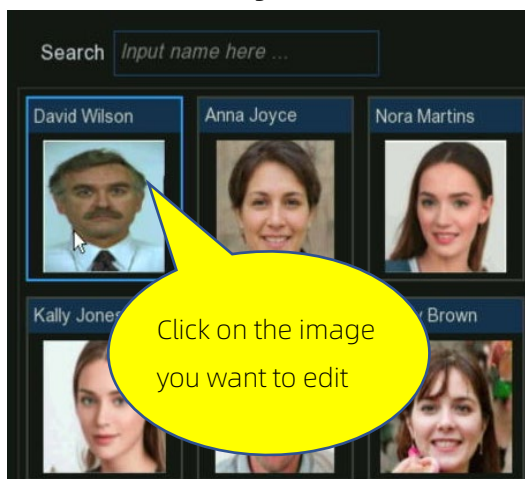

4. With the pop-up menu, you're able to:

- **Edit:** Click to edit the face profile. Check how to edit the profile in 5.4.2.2.2 Create Individual Face Profile from External Storage Device.
- **Move To:** Click to move the face to another group.

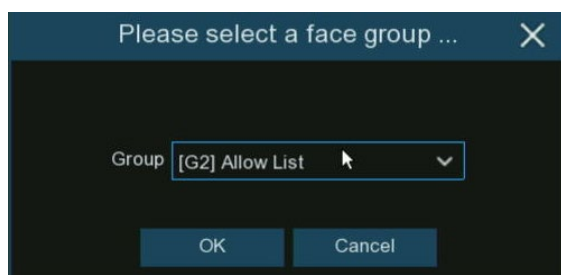

Choose the target group, and then click OK.

- **Delete:** To delete the selected face profile.
- **Detail Information:** Click to view the details of the selected face profile.

Detail Information

Group: Block List

Name: David Wilson Gender: Male

Age: 30 Country: UK

Nationality: English Native Place: England

ID Code: 123456799

Occupation: Scientist

Phone Number: 07-123 456 799 Email: test@xxxxxx.com

Residence: No. xx, Downing Street, London

Remark: Test 88

Additional Face Image

Modify Exit



5.4.2.3 License Plate Management

The License Plate Management menu allows you to set up and maintain a database of vehicle license plates organized into different groups. You're able to create and manage the vehicle license plate profiles (database) to classify different vehicles into different groups in order to quickly identify vehicles remotely and trigger intelligent alarms proactively.

		Group Name	+/-	Edit	Enable
1	<input checked="" type="checkbox"/>	Allow List			<input checked="" type="checkbox"/>
2	<input checked="" type="checkbox"/>	Block List			<input checked="" type="checkbox"/>
3	<input type="checkbox"/>	Unknown			<input checked="" type="checkbox"/>

There are 3 default groups:

- **Allow List:** Mostly used to define a list of vehicles that are regarded as acceptable or trustworthy.
- **Block List:** Mostly used to define a list of vehicles that are regarded as unacceptable or untrustworthy and should be excluded or avoided.
- **Unknown:** All ungrouped vehicles will be identified as unknown vehicles.

You can click the add button  to create a customized group or click the delete button  to remove a customized group.

If you want to backup your license plate database, use the "**Backup Database**" function to export it to a USB flash drive. The exported database can be imported to the same or another NVR by using the "**Import Database**" function.

Tick the "**Enable**" checkbox to activate a group. You will need to create vehicle license plate profiles (add license numbers) to the groups in order to enable effective vehicle identification and alarms.

Note: The maximum number to create vehicle license plate profiles in each group is 5,000.

5.4.2.3.1 Create License Profiles from Local Storage Device

This section will show how to create vehicle profiles from license plate images that have been captured and stored on your NVR.

1. Click the edit button  of the group that you would like to create vehicle license plate profiles for.



2. Click the "**Import from Local**" button at the bottom of the page.

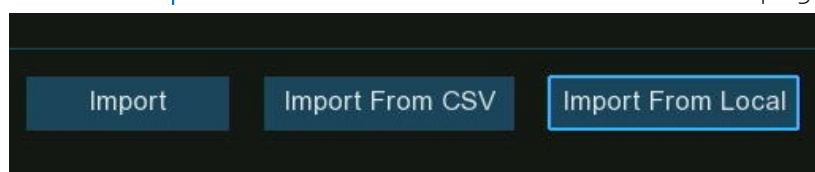

- On the pop-up page, perform the following operations in order to select the vehicle license image(s):

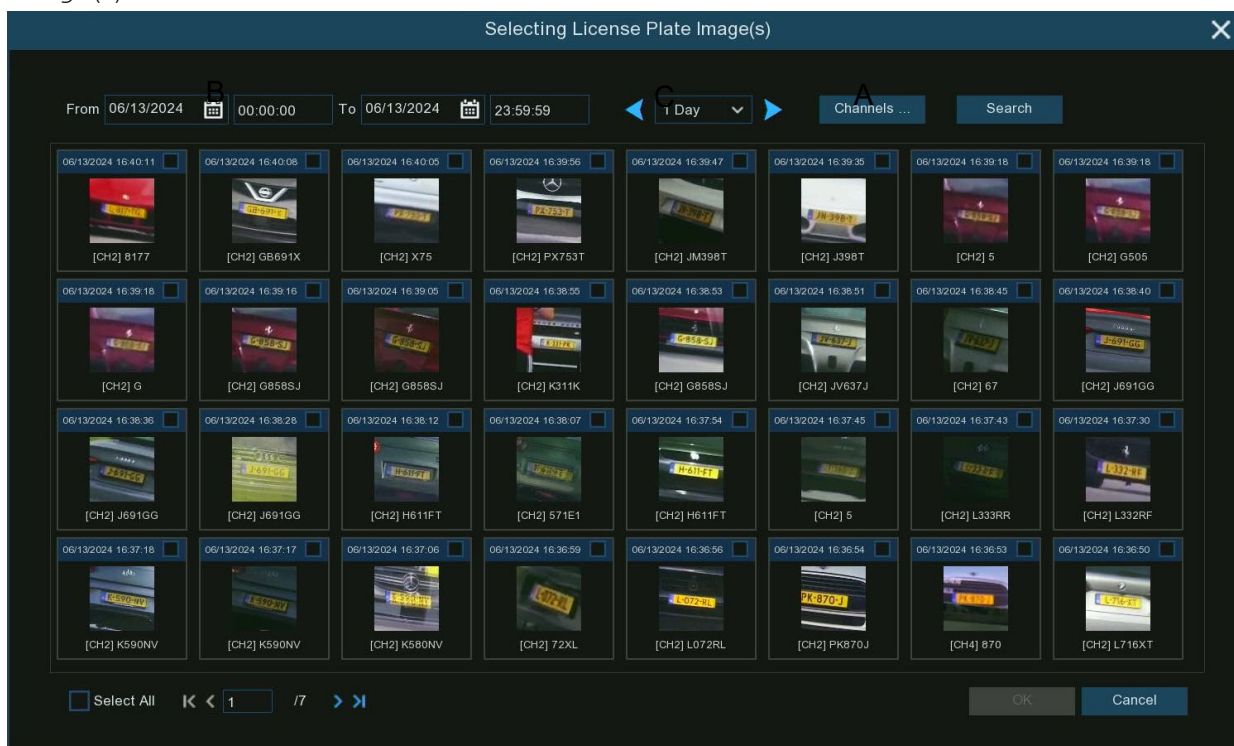

- First, select the channels you need to search on. All channels are set to search by default. You can specify the cameras you want to search on.
- Use the calendar to specify the date range.
- Choose the day duration, and then use the arrow buttons to quickly display license plate images from the previous or next day(s).
- All license plate images captured within the specified date range will be automatically displayed in the list. Use the arrow buttons to display previous or next page of results.
- Tick the checkbox in the top right corner of the images to select the license plate images you want to import, and then click OK button.

- You will now see a list of license plate numbers. Click on one of the license numbers, and the detailed information will be listed on the right side. You're able to edit the information, including license plate number, color, brand, model of the vehicle, and the owner's profile.

- Click **"Import"** button after finishing the information input, and the selected license plate numbers will be added.

5.4.2.3.2 Manually Create License Profiles

This section will show how to create vehicle profiles manually.

















- Click the **"Edit"** button of the group that you would like to create vehicle license plate profiles for.

- Click the **"Import"** button at the bottom of the page.

- In the pop-up window, enter the license plate details, including the number, color, brand, model/type of the vehicle, and the owner's information.

- Click the setup button  next to the "License Plate" field to configure the voice prompt for the vehicle. See [Section 5.3.8. Voice Prompts](#) to learn how to set up this feature.
- Note: The voice file imported here applies only to this specific vehicle. If you have set multiple time periods, you need to import a voice file for each period.

Channel	Local	IP Camera
	<input checked="" type="checkbox"/>	<input type="checkbox"/>

Voice Prompts	Start Time	End Time	Import	Delete	Volume
	00:00:00	~ 23:59:59			
	00:00:00	~ 23:59:59			
	00:00:00	~ 23:59:59			
	00:00:00	~ 23:59:59			

- Click the setup button  next to "Alarm Channel" to configure the Alarm Channel. The system will trigger an alert when this license plate is detected and captured by the selected cameras.
- Click the "Import" button to import the license profile.
- Click the Import button after finishing the information input, then click Exit to finish.

5.4.2.3.3 Create Bulk License Profiles

If you want to create multiple license plate profiles at once, follow these steps:

Insert your USB flash drive into the USB port of the NVR.

1. Click the edit button  of any one of groups that already contains at least one existing vehicle license plate profile.



2. From the Group window, select one or more of the existing license plate profiles, and then click the "Export" button.

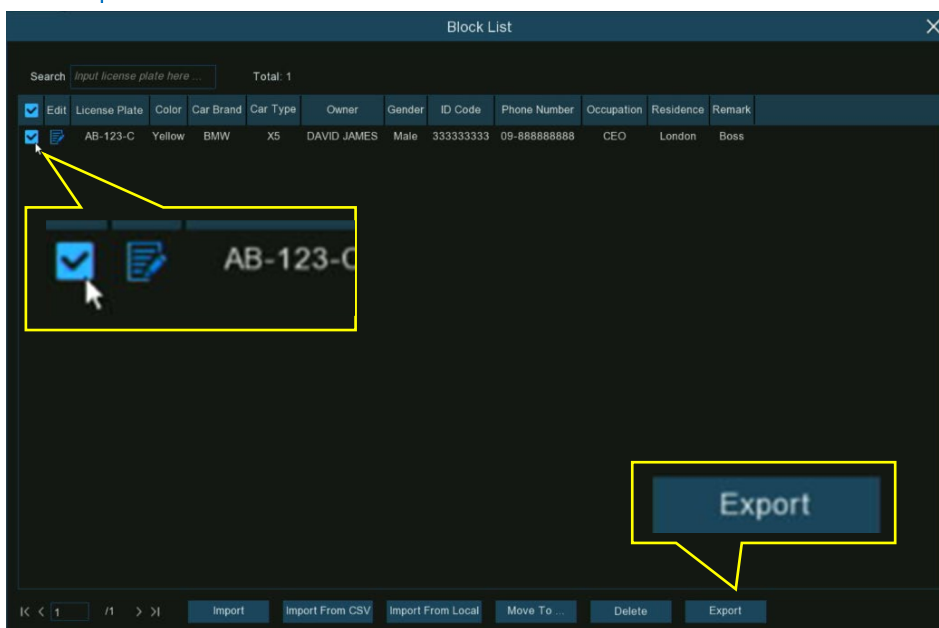

3. A ".csv" file containing the selected profiles will be exported and saved to your USB flash drive.

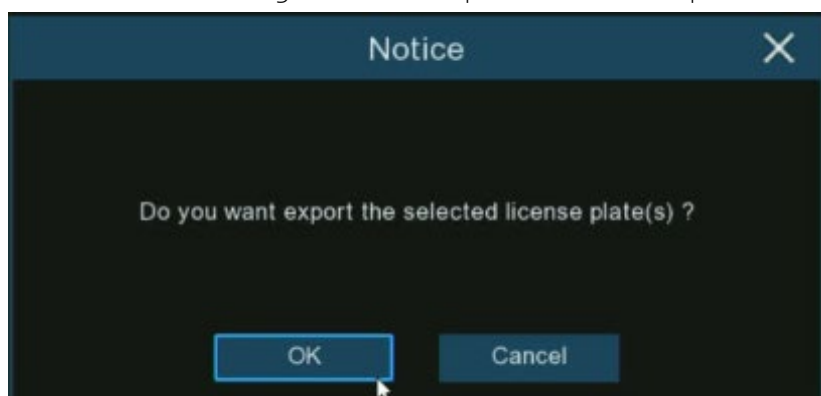

Click **OK** button.

4. Select the directory where you want to save the exported file, and then click "OK".

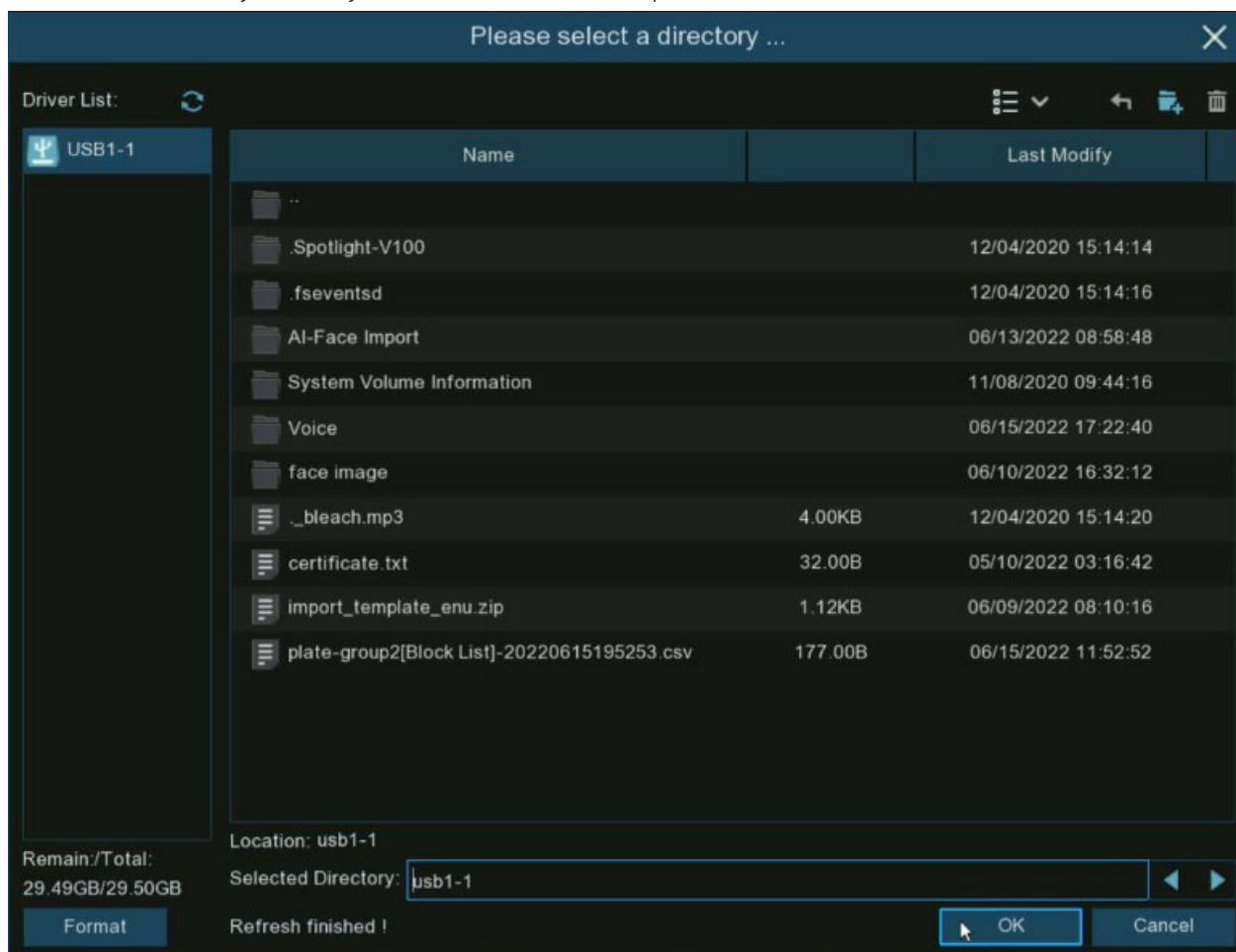

5. On your computer, double-click the exported ".csv" file to open it with a spreadsheet program like Excel. The file contents will be displayed with the following column headers:

A	B	C	D	E	F	G	H	I	J	K
License Plate	Color	Car Brand	Car Type	Owner	Gender	ID Code	Phone Number	Occupation	Residence	Remark
AB-123-C	blue	BMW	X5	David James	male	1.23457E+17	09-788 788 788	CEO	No. 10, xxx Road, London	Boss

- Column A: License plate number
- Column B: Vehicle color
- Column C: Vehicle brand
- Column D: Vehicle type/model
- Column E: Vehicle owner's name
- Column F: Vehicle owner's gender
- Column G: Vehicle owner's ID number
- Column H: Vehicle owner's phone number
- Column I: Vehicle owner's occupation/job
- Column J: Vehicle owner's residence address
- Column K: Additional remarks

- Edit the cells in the spreadsheet according to the actual information for the new license plates you want to add:

License Plate	Color	Car Brand	Car Type	Owner	Gender	ID Code	Phone Number	Occupation	Residence	Remark
AB-123-2	blue	BMW	X5	Anna Joyce	Female	12345678911111	09-788 788 788	Professor	No. 10, xxx Road, London	
AB-123-3	yellow	Lamborghini	Huracan	Nora Martins	Female	12345678911111	09-788 788 789	Professor	No. 11, xxx Road, London	Boss
AB-123-4	black	Volkswagen	Bora	Shelly Clinton	Female	12345678911111	09-788 788 790	Editor	No. 12, xxx Road, London	
AB-123-5	green	Hyundai	Tucson	Sinna Donald	Female	12345678911111	09-788 788 791	Photographer	No. 13, xxx Road, London	
AB-123-6	black	Toyota	Highlander	James Timothy	Male	12345678911111	09-788 788 792	Director	No. 14, xxx Road, London	
AB-123-7	white	Honda	Accord	Juelly Smith	Female	12345678911111	09-788 788 793	Cashier	No. 15, xxx Road, London	
AB-123-8	black	Peugeot	4008	Kally Jones	Female	12345678911111	09-788 788 794	Reporter	No. 16, xxx Road, London	
AB-123-9	black	Chevrolet	Blazer	Kevin Williams	Male	12345678911111	09-788 788 795	Manager	No. 17, xxx Road, London	

Please Note: If you input an uninterrupted number more than 11 digits in a cell, the system will display it in scientific notation, e.g. "1.23457E+11". If so, you need to adjust the column format to "Text".

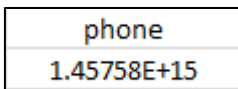

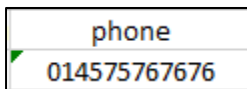

NG

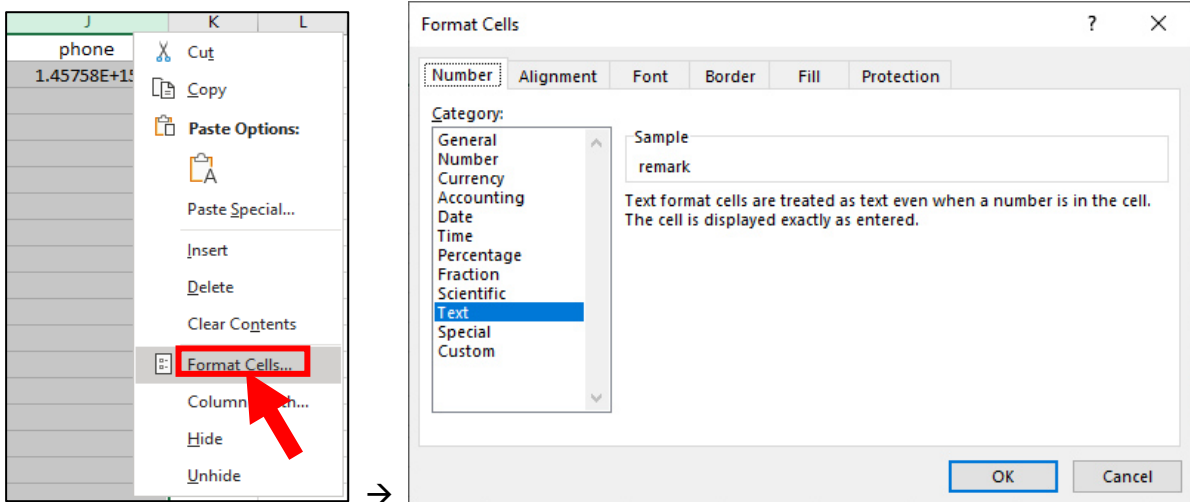

Good

- Select the column (especially ID code and phone number columns) and right-click. Click "Format Cells..." on the pop-up menu, and then choose "Text" and click "OK".



- Save the edited ".csv" file, ensuring it is saved as a CSV UTF-8 file type.
- Copy the edited ".csv" file to your USB flash drive, and then insert the USB drive into a USB port on the NVR
- Click the "Edit" button  of the group you want to import the new vehicle profiles into



11. Click "Import from CSV", select the ".csv" file from the USB drive, and click "OK".

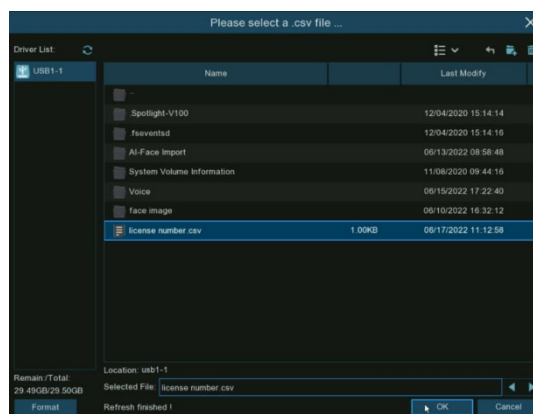
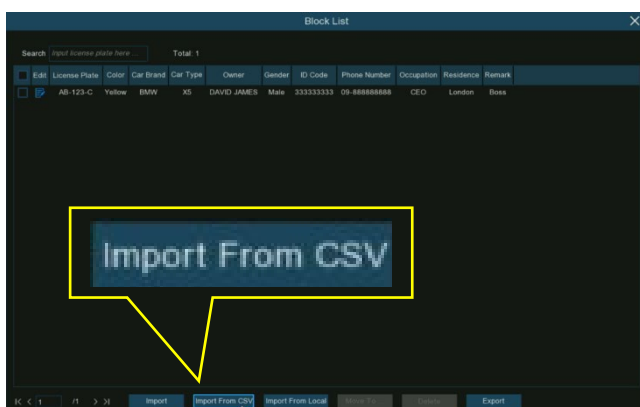

12. You will now see a list of license plate numbers. Click on a number to view its detailed information on the right side. Click "Import" to import all the new profiles into the NVR, then click "Exit" to finish.

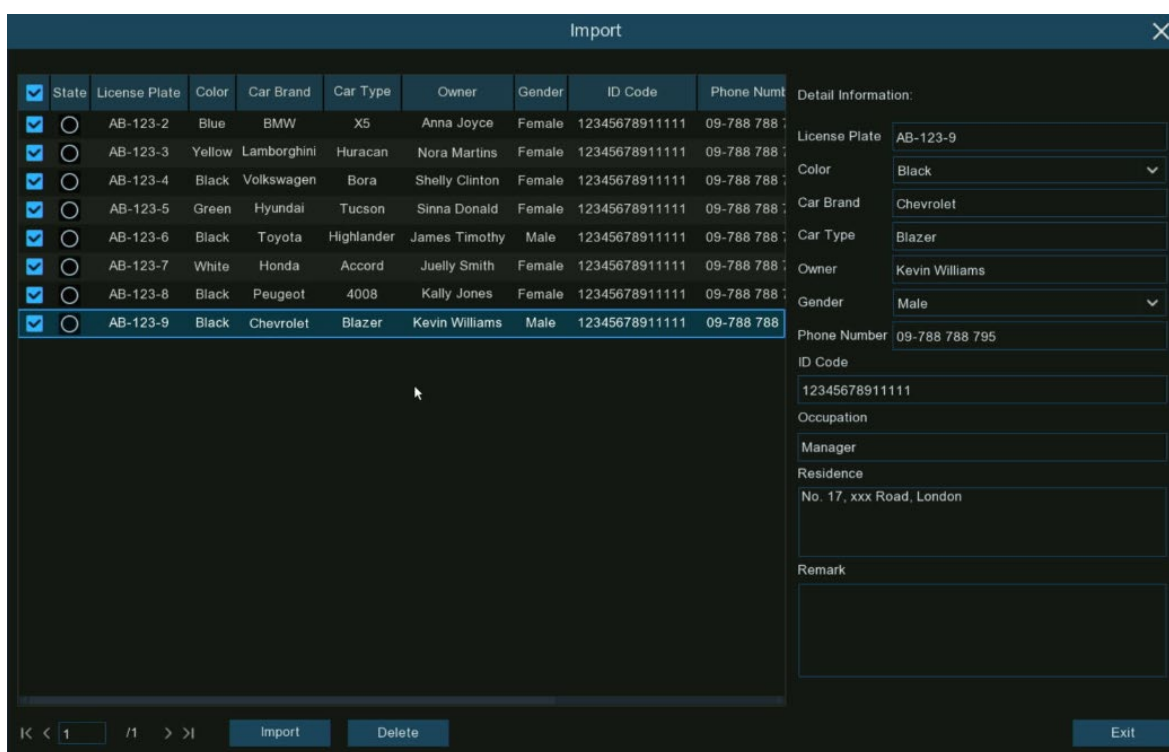

5.4.2.3.4 Edit License Profiles

If you need to edit or delete an existing license plate profile, follow these steps:

1. Click the edit button  of the group containing the vehicle license plate profiles you want to modify.



2. To edit a license plate profile's information, click the edit button  next to the license plate number you want to change.



3. Modify the information in the Edit window as needed, and then click the "Modify" button to apply the changes.

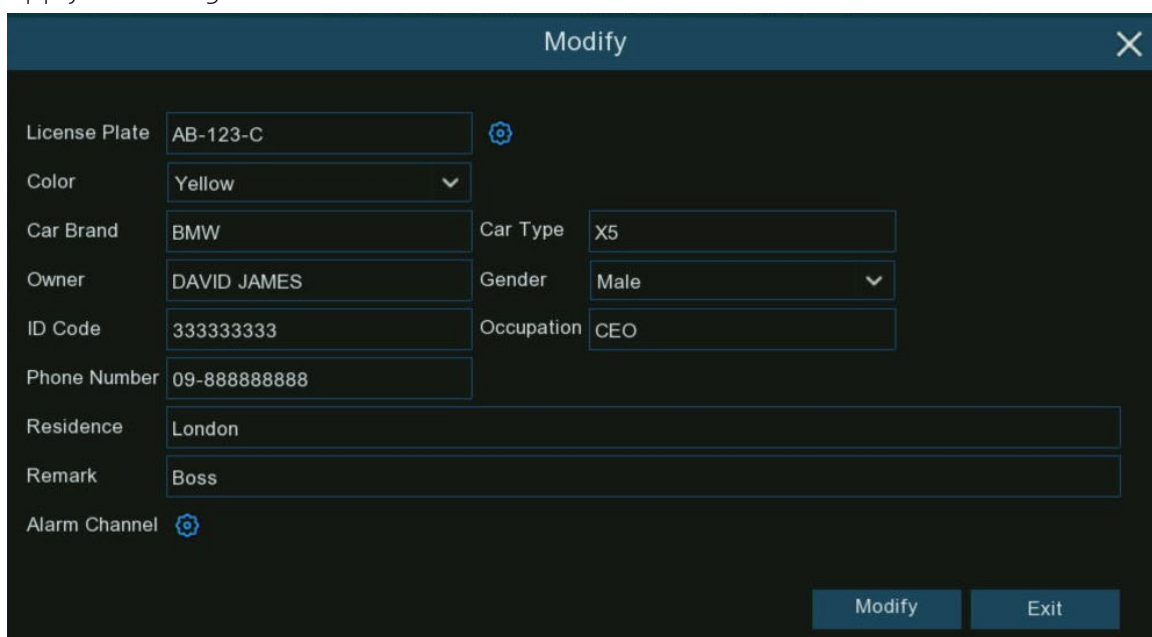

4. If you want to delete, move or export license profile(s), please proceed as below.

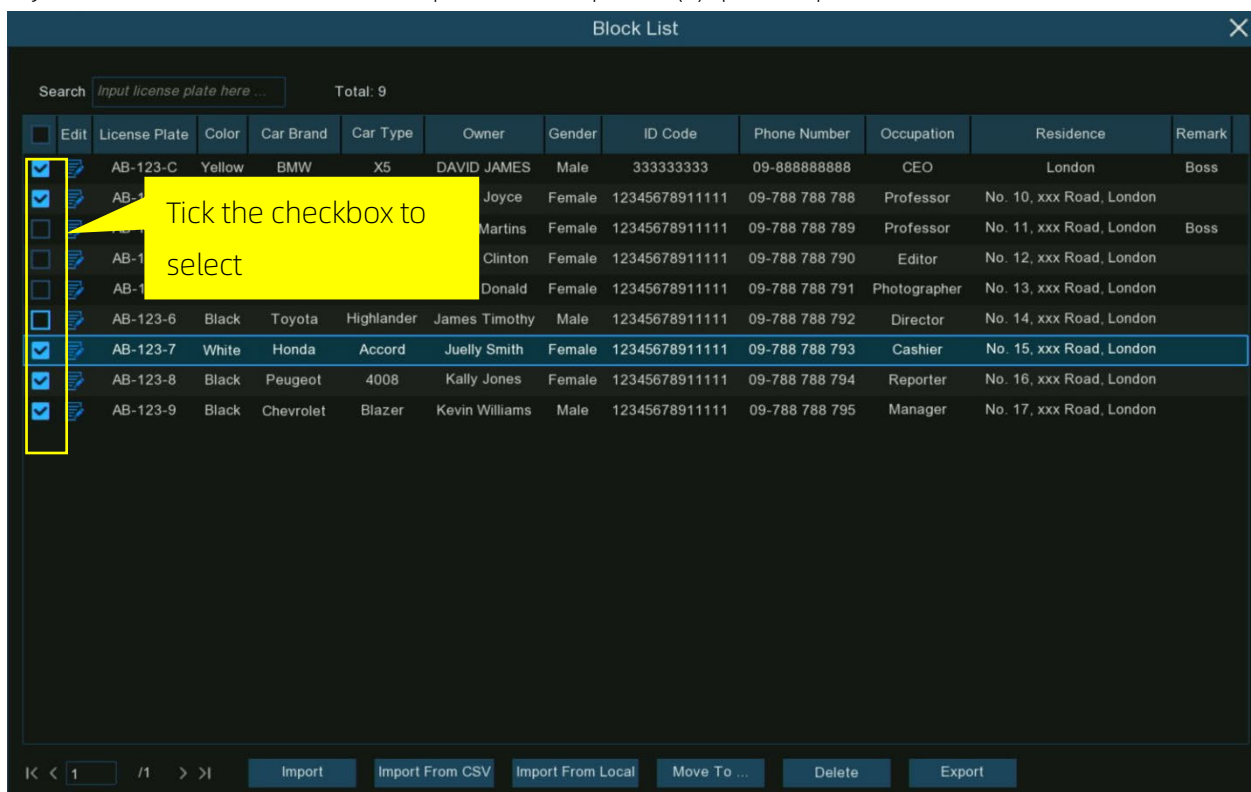

First, tick the checkbox next to each profile you want to take action on

- If deleting, click the "Delete" button and confirm to permanently remove the selected profile(s).
- If moving profiles to another group, click "Move To..." and then select the destination group.
- If exporting profiles to a USB drive, click "Export" to save the selected profile details to a ".csv" file.

5.4.3 AI Alarm Settings

In this section, you can configure alarm actions that will be triggered when certain events are detected by AI.

5.4.3.1 Alarm Settings for Face Detection

In this menu, you can configure alarm actions when faces are detected.

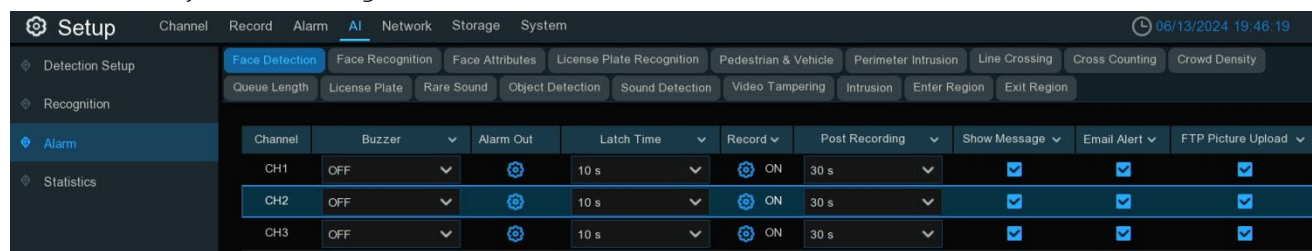



Buzzer: When a detection event triggers, you can enable the NVR's buzzer to provide an audible alert for a preset duration. Click the drop-down menu to select the desired time.

Alarm Out: If your NVR or IP camera supports connecting external alarm output devices, the system can send an alert notification to these devices. Click  button to choose the external alarm devices:



- **Local->x:** External alarm devices connected directly to the NVR.
- **CHx->1:** External alarm devices connected to the IP cameras.

Latch Time: Configure the duration for which external alarms will be activated when a detection event triggers.

Record: This option instructs your NVR to trigger recording on additional cameras when a detection event triggers. Click the drop-down arrow  to choose whether to record on all channels or not. Click  button, then click the "Record Channel" checkbox to enable recording. Click the checkbox in front of the channel number to select all channels for recording, or click on individual camera numbers to select them for triggered recording.

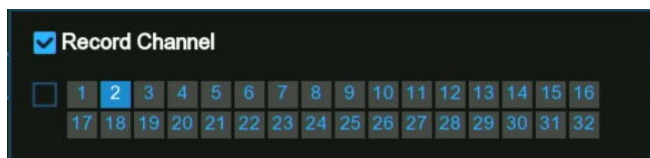

Post Recording: This option sets your NVR to continue recording for a specified time after an event has occurred. The default selection is suitable for most cases, but you can modify it if needed.

Show Message: When a detection event triggers, the alarm icon  will appear on the screen.

Email Alert: An email alert will be sent when a detection event triggers. Tick the checkbox if you want to disable this.

FTP Picture Upload: Check this box to upload snapshots to your FTP server when a detection event triggers.

FTP Video Upload: Check this box to upload video clips to your FTP server when a detection event triggers.

Picture to Cloud: Check this box to upload snapshots to your cloud storage (Dropbox or Google Drive) when a detection event triggers.

Video to Cloud: Check this box to upload video clips to your cloud storage (Dropbox or Google Drive) when a detection event triggers. Due to system limitations, regardless of the alarm type, a maximum of two channels' videos can be selected for uploading in total for all alarm types.

Full Screen: Check this box to display the triggered camera feed in full-screen Live View mode when a detection event triggers.

Event Push Platform: Check this option to push notifications of this alarm event type to the client software/app when triggered. See section [5.5.6 platform Access](#) for settings of push platform.

Voice Prompts: If your NVR is connected to a speaker, you can select a customized voice alert to play when a detection event triggers. See section [5.3.8 Voice Prompts](#) for adding custom voice alerts.

Default: Click "Default" to revert all settings to their default values.

Copy: Use the "Copy" function to apply the current settings to other connected cameras.

Apply: Click "Apply" to save settings.

5.4.3.2 Alarm Settings for Face Recognition

In this menu, you can configure different alarm actions when faces belonging to different groups are captured and successfully recognized.

















		Group Name	Alarm	Policy	Similarity	Alarm	Alarm Schedule	Alarm Channel
1	<input checked="" type="checkbox"/>	Allow List	<input checked="" type="checkbox"/>	Allowed	≥ 70 %			
2	<input checked="" type="checkbox"/>	Block List	<input checked="" type="checkbox"/>	Disallowed	≥ 70 %			
3	<input type="checkbox"/>	Stranger	<input checked="" type="checkbox"/>	Stranger	< 70 %			
4	<input checked="" type="checkbox"/>	Group 1	<input checked="" type="checkbox"/>	Allowed	≥ 70 %			
5	<input checked="" type="checkbox"/>	Group 2	<input checked="" type="checkbox"/>	Disallowed	≥ 70 %			
6	<input checked="" type="checkbox"/>	Group 3	<input checked="" type="checkbox"/>	Disallowed	≥ 70 %			

Alarm: Tick the checkboxes for the groups you want to enable alarm functions for. If a group is not enabled, the NVR will not trigger any alarm actions for that group. It is highly recommended to keep the "Stranger" group enabled to save images of any unrecognized faces to the database. These images can later be used to create or improve face profiles in the other groups.

Policy: This setting cannot be configured for the three preset face groups (Allow List, Block List, Stranger). If you have created a custom group, you can set its policy to either Allow or Disallowed. The Disallowed/Disallow label under the Policy setting is just a group category label for easier organization, and does not inherently dictate the system's alarm behavior. The actual actions the system will take when a face is recognized are determined by the specific "Alarm" settings configured for that group.

Similarity: Set the percentage threshold for how closely a detected face must match a group's profile to be considered a recognized match. The default is 70%. A higher similarity percentage will result in fewer false positives.

Alarm: Click setup button  to specify the actions the NVR should take when a face recognition event occurs for this group

Channel	Buzzer	Alarm Out	Latch Time	Face Capture	Save Background	Show Thumbnail	Send Email	FTP Picture Upload	Picture to Cloud	Voice Prompts
CH1	Disable		10 s	<input checked="" type="checkbox"/>	<input checked="" type="checkbox"/>	<input checked="" type="checkbox"/>	<input type="checkbox"/>	<input checked="" type="checkbox"/>	<input type="checkbox"/>	
CH2	Disable		10 s	<input checked="" type="checkbox"/>	<input checked="" type="checkbox"/>	<input checked="" type="checkbox"/>	<input type="checkbox"/>	<input checked="" type="checkbox"/>	<input type="checkbox"/>	
CH3	Disable		10 s	<input checked="" type="checkbox"/>	<input checked="" type="checkbox"/>	<input checked="" type="checkbox"/>	<input type="checkbox"/>	<input checked="" type="checkbox"/>	<input type="checkbox"/>	
CH4	Disable		10 s	<input checked="" type="checkbox"/>	<input checked="" type="checkbox"/>	<input checked="" type="checkbox"/>	<input type="checkbox"/>	<input checked="" type="checkbox"/>	<input type="checkbox"/>	
CH5	Disable		10 s	<input checked="" type="checkbox"/>	<input checked="" type="checkbox"/>	<input checked="" type="checkbox"/>	<input type="checkbox"/>	<input checked="" type="checkbox"/>	<input type="checkbox"/>	
CH6	Disable		10 s	<input checked="" type="checkbox"/>	<input checked="" type="checkbox"/>	<input checked="" type="checkbox"/>	<input type="checkbox"/>	<input checked="" type="checkbox"/>	<input type="checkbox"/>	
CH7	Disable		10 s	<input checked="" type="checkbox"/>	<input checked="" type="checkbox"/>	<input checked="" type="checkbox"/>	<input type="checkbox"/>	<input checked="" type="checkbox"/>	<input type="checkbox"/>	
CH8	Disable		10 s	<input checked="" type="checkbox"/>	<input checked="" type="checkbox"/>	<input checked="" type="checkbox"/>	<input type="checkbox"/>	<input checked="" type="checkbox"/>	<input type="checkbox"/>	

- **Buzzer:** When a detection event triggers, you can enable the NVR's buzzer to provide an audible alert for a preset duration. Click the drop-down menu to select the desired time.
- **Alarm Out:** If your NVR or IP camera supports connecting external alarm output devices, the system can send an alert notification to these devices. Click  button to choose the external alarm devices:

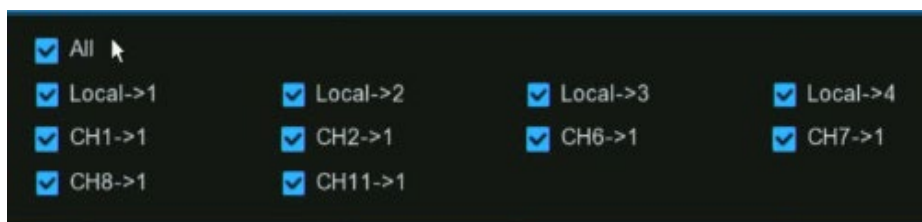

- **Local->x:** External alarm devices connected directly to the NVR.
- **CHx->1:** External alarm devices connected to the IP cameras.
- **Latch Time:** Configure the duration for which external alarms will be activated when a detection event triggers.
- **Capture Face:** When a face is detected, a snapshot of the face will be captured and saved.
- **Save Background:** When a face is detected, the entire preview image at that moment will be saved.
- **Show Thumbnail:** When a face is detected, a thumbnail preview will pop up in the Alarm Notification Panel. Refer to Section [4.2.3 Alarm Popup](#).
- **Email Alert:** An email alert will be sent when a detection event triggers. Tick the checkbox if you want to disable this.
- **FTP Picture Upload:** Check this box to upload snapshots to your FTP server when a detection event triggers.
- **Picture to Cloud:** Check this box to upload snapshots to your cloud storage (Dropbox or Google Drive) when a detection event triggers.
- **Event Push Platform:** Check this option to push notifications of this alarm event type to the client software/app when triggered. See section [5.5.6 platform Access](#) for settings of push platform.

- **Voice Prompts:** If your NVR is connected to a speaker, you can select a customized voice alert to play when a detection event triggers. See section [5.3.8 Voice Prompts](#) for adding custom voice alerts.

Alarm Schedule: Click setup button  to configure the schedule for when this group's alarm actions will be active.



Click or drag the mouse over the schedule to select the time slots. The blue sections indicate the active periods when the configured alarm actions will be triggered if a qualifying event occurs. The schedule applies only to the currently selected camera channel. To apply the same schedule to other channels, use the Copy function. Click Save to save your scheduling settings.

Alarm Channel: Click setup button  to select the camera channel(s) that will trigger the configured alarm actions when detecting and identifying a face in this group.

5.4.3.3 Alarm Settings for Face Attributes

This function allows you to detect specific facial attributes of people (currently only face mask detection is supported) and trigger alarms based on your configured settings for those attributes.

Note: If you want to use this feature, ensure that Face Attributes has been enabled in the Face Detection settings. Refer to [5.4.1.1 Face Detection](#) for more details.

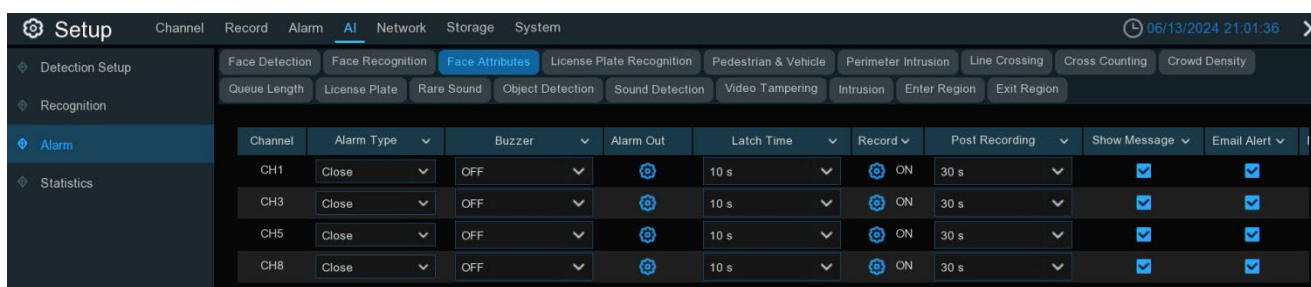

Alarm Type: Select the facial attribute that you need to detect.

- **No Mask:** When a person is detected without wearing a face mask, the NVR will take the corresponding actions based on the configured alarm behaviors.
- **Wear Mask:** When a person is detected wearing a face mask, the NVR will take the corresponding actions based on the configured alarm behaviors.
- **Close:** The face attribute detection feature will be disabled.

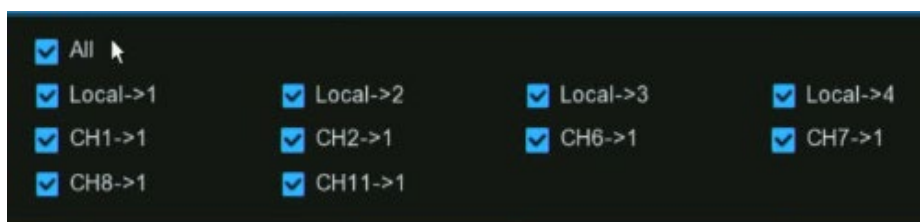

Buzzer: When a detection event triggers, you can enable the NVR's buzzer to provide an audible alert for a preset duration. Click the drop-down menu to select the desired time.

Alarm Out: If your NVR or IP camera supports connecting external alarm output devices, the system can send an alert notification to these devices. Click  button to choose the external alarm devices.



- **Local->x:** External alarm devices connected directly to the NVR.
- **CHx->1:** External alarm devices connected to the IP cameras.

Latch Time: Configure the duration for which external alarms will be activated when a detection event triggers.

Record: This option instructs your NVR to trigger recording on additional cameras when a detection event triggers. Click the drop-down arrow  to choose whether to record on all channels or not. Click  button, then click the "Record Channel" checkbox to enable recording. Click the checkbox in front of the channel number to select all channels for recording, or click on individual camera numbers to select them for triggered recording.



Post Recording: This option sets your NVR to continue recording for a specified time after an event has occurred. The default selection is suitable for most cases, but you can modify it if needed.

Show Message: When a detection event triggers, the alarm icon  will appear on the screen.

Email Alert: An email alert will be sent when a detection event triggers. Tick the checkbox if you want to disable this.

Full Screen: Check this box to display the triggered camera feed in full-screen Live View mode when a detection event triggers.

Event Push Platform: Check this option to push notifications of this alarm event type to the client software/app when triggered. See section [5.5.6 platform Access](#) for settings of push platform.

Voice Prompts: If your NVR is connected to a speaker, you can select a customized voice alert to play when a detection event triggers. See section [5.3.8 Voice Prompts](#) for adding custom voice alerts.

Default: Click "Default" to revert all settings to their default values.

Copy: Use the "Copy" function to apply the current settings to other connected cameras.

Apply: Click "Apply" to save settings.

5.4.3.4 Alarm Settings for License Plate Recognition

In this menu, you can configure different alarm actions when vehicle license plates belonging to different groups are captured and successfully recognized.

	Group Name	Alarm	Policy	Fault Tolerance	Alarm	Alarm Schedule	Alarm Channel
1	Allow List	<input checked="" type="checkbox"/>	Allowed	≤ 1 character(s)	<input type="checkbox"/>	<input type="checkbox"/>	<input type="checkbox"/>
2	Block List	<input checked="" type="checkbox"/>	Disallowed	≤ 1 character(s)	<input type="checkbox"/>	<input type="checkbox"/>	<input type="checkbox"/>
3	Unknown	<input type="checkbox"/>	Unknown	> 1 character(s)	<input type="checkbox"/>	<input type="checkbox"/>	<input type="checkbox"/>
4	Group 1	<input checked="" type="checkbox"/>	Allowed	≤ 1 character(s)	<input type="checkbox"/>	<input type="checkbox"/>	<input type="checkbox"/>
5	Group 2	<input checked="" type="checkbox"/>	Allowed	≤ 1 character(s)	<input type="checkbox"/>	<input type="checkbox"/>	<input type="checkbox"/>

Alarm: Tick the checkboxes for the groups you want to enable alarm functions for. If a group is not enabled, the NVR will not trigger any alarm actions for that group. It is highly recommended to keep the "Unknown" group enabled to save images of any unrecognized license plates to the database. These images can later be used to create or improve license plate profiles in the other groups.

Policy: This setting cannot be configured for the three preset license plate groups (Allow List, Block List, Stranger). If you have created a custom group, you can set its policy to either Allow or Disallowed. The Disallowed/Disallow label under the Policy setting is just a group category label for easier organization, and does not inherently dictate the system's alarm behavior. The actual actions the system will take when a license plate is recognized are determined by the specific "Alarm" settings configured for that group.

Faulty Tolerance: Fault Tolerance: Due to variations in image resolution, light strength, camera angles, moving speed of the vehicle, etc., some characters in the license plate number might fail to be recognized correctly. Set the Fault Tolerance to specify how many characters the detected license

plate is allowed to differ from the license plate numbers saved in the group. If the number of differing characters between the detected license plate number and a license plate profile in the group is no more than the set Fault Tolerance value, the detected license plate will be considered a recognized match.

The examples provided help illustrate how the "Fault Tolerance" setting works:

Recognized License Number	Number in License Profile	Fault Tolerance	Recognition Result
AB123C	AB-123-C	≤2 characters	True
AB123C	AB-123-C	≤0 or 1 character	False
A8123C	AB123C	≤2 characters	True
A8123C	AB123C	≤0 or 1 character	False
B594SB	B734KB	≤3 characters	True
B594SB	B734KB	≤2 character	False
AB132C	AB123C	≤2 characters	True
AB123C	AB123C	≤0 or 1 character	False

Note: The system will only recognize English letters and digit numbers. Special symbols, such as underline (_), virgule (/), hyphen (-), will be excluded from recognition. Please set the Fault Tolerance accordingly if you have included special symbols in the license plate number when creating a license profile.

Alarm: Click setup button  to specify the actions the NVR should take when a face recognition event occurs for this group

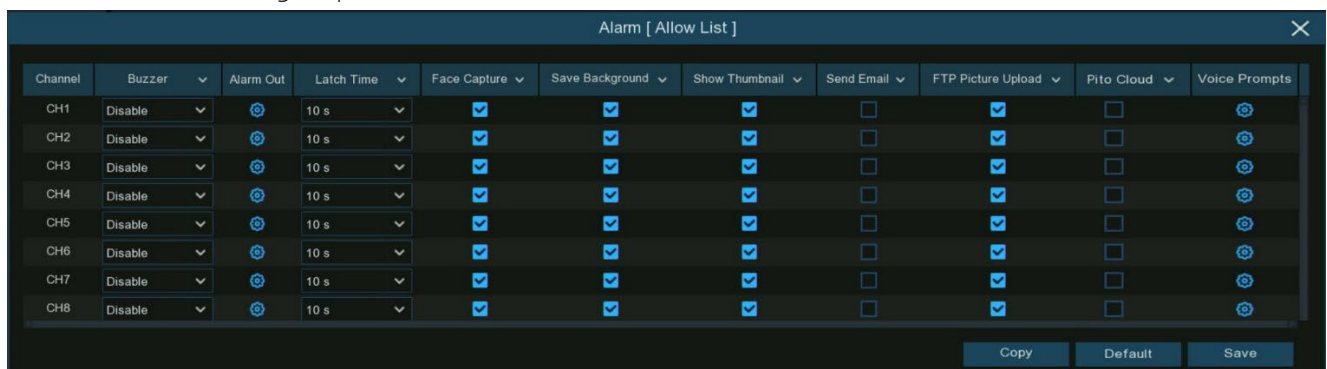

- **Buzzer:** When a detection event triggers, you can enable the NVR's buzzer to provide an audible alert for a preset duration. Click the drop-down menu to select the desired time.
- **Alarm Out:** If your NVR or IP camera supports connecting external alarm output devices, the system can send an alert notification to these devices. Click  button to choose the external alarm devices:

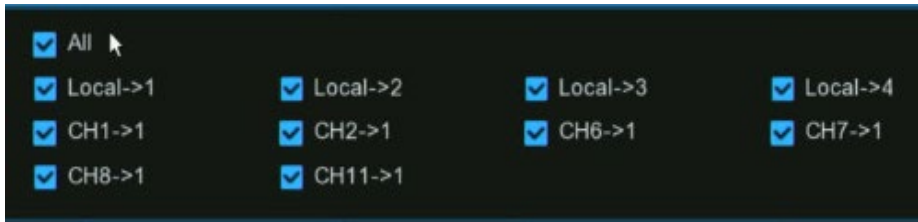

- **Local->x:** External alarm devices connected directly to the NVR.
- **CHx->1:** External alarm devices connected to the IP cameras.
- **Latch Time:** Configure the duration for which external alarms will be activated when a detection event triggers.
- **Capture Face:** When a face is detected, a snapshot of the face will be captured and saved.
- **Save Background:** When a face is detected, the entire preview image at that moment will be saved.
- **Show Thumbnail:** When a face is detected, a thumbnail preview will pop up in the Alarm Notification Panel. Refer to Section [4.2.3 Alarm Popup](#).
- **Email Alert:** An email alert will be sent when a detection event triggers. Tick the checkbox if you want to disable this.
- **FTP Picture Upload:** Check this box to upload snapshots to your FTP server when a detection event triggers.
- **Picture to Cloud:** Check this box to upload snapshots to your cloud storage (Dropbox or Google Drive) when a detection event triggers.
- **Event Push Platform:** Check this option to push notifications of this alarm event type to the client software/app when triggered. See section [5.5.6 platform Access](#) for settings of push platform.
- **Voice Prompts:** If your NVR is connected to a speaker, you can select a customized voice alert to play when a detection event triggers. See section [5.3.8 Voice Prompts](#) for adding custom voice alerts.

Alarm Schedule: Click setup button  to configure the schedule for when this group's alarm actions will be active.

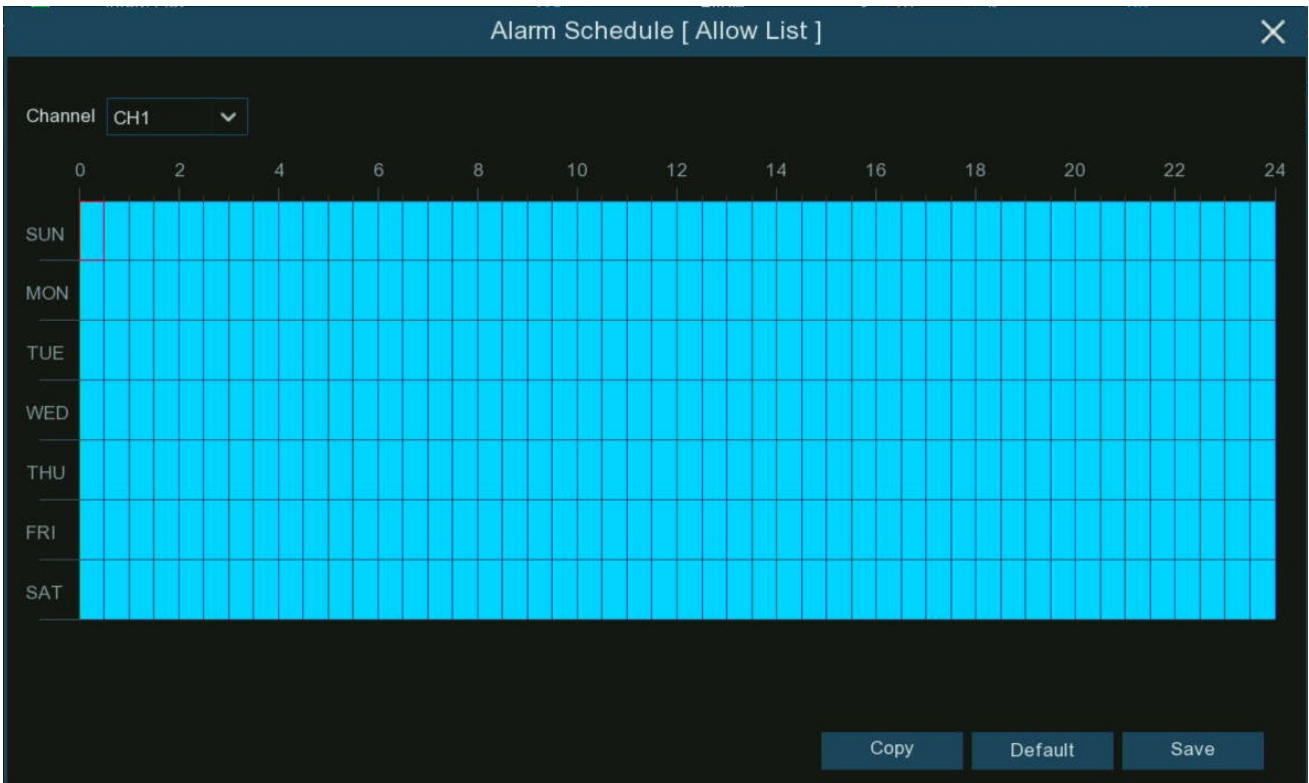

Click or drag the mouse over the schedule to select the time slots. The blue sections indicate the active periods when the configured alarm actions will be triggered if a qualifying event occurs. The schedule applies only to the currently selected camera channel. To apply the same schedule to other channels, use the Copy function. Click Save to save your scheduling settings.

Alarm Channel: Click setup button  to select the camera channel(s) that will trigger the configured alarm actions when detecting and identifying a face in this group.

5.4.3.5 Alarm Settings for Pedestrian & Vehicle and Other Detection Types

This section covers the alarm settings specifically for pedestrian and vehicle detection, as well as other detection types. You can configure how and when the system triggers alarms for these different detection features, ensuring tailored surveillance and alert mechanisms based on the detection type.

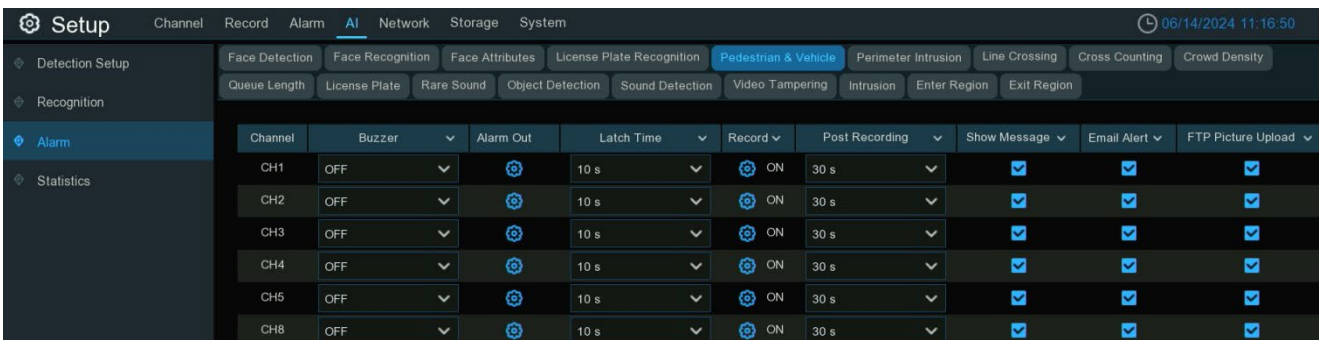



Buzzer: When a detection event triggers, you can enable the NVR's buzzer to provide an audible alert for a preset duration. Click the drop-down menu to select the desired time.

Alarm Out: If your NVR or IP camera supports connecting external alarm output devices, the system can send an alert notification to these devices. Click  button to choose the external alarm devices:



- **Local->x:** External alarm devices connected directly to the NVR.
- **CHx->1:** External alarm devices connected to the IP cameras.

Latch Time: Configure the duration for which external alarms will be activated when a detection event triggers.

Record: This option instructs your NVR to trigger recording on additional cameras when a detection event triggers. Click the drop-down arrow  to choose whether to record on all channels or not. Click  button, then click the "Record Channel" checkbox to enable recording. Click the checkbox in front of the channel number to select all channels for recording, or click on individual camera numbers to select them for triggered recording.

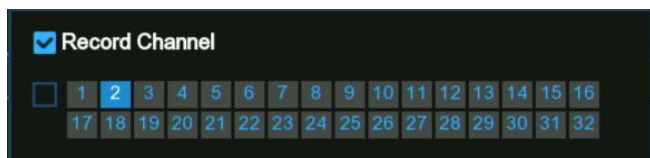

Post Recording: This option sets your NVR to continue recording for a specified time after an event has occurred. The default selection is suitable for most cases, but you can modify it if needed.

Show Message: When a detection event triggers, the alarm icon  will appear on the screen.

Email Alert: An email alert will be sent when a detection event triggers. Tick the checkbox if you want to disable this.

FTP Picture Upload: Check this box to upload snapshots to your FTP server when a detection event triggers.

FTP Video Upload: Check this box to upload video clips to your FTP server when a detection event triggers.

Picture to Cloud: Check this box to upload snapshots to your cloud storage (Dropbox or Google Drive) when a detection event triggers.

Video to Cloud: Check this box to upload video clips to your cloud storage (Dropbox or Google Drive) when a detection event triggers. Due to system limitations, regardless of the alarm type, a maximum of two channels' videos can be selected for uploading in total for all alarm types.

Full Screen: Check this box to display the triggered camera feed in full-screen Live View mode when a detection event triggers.

Event Push Platform: Check this option to push notifications of this alarm event type to the client software/app when triggered. See section [5.5.6 platform Access](#) for settings of push platform.

Voice Prompts: If your NVR is connected to a speaker, you can select a customized voice alert to play when a detection event triggers. See section [5.3.8 Voice Prompts](#) for adding custom voice alerts.

Default: Click "Default" to revert all settings to their default values.

Copy: Use the "Copy" function to apply the current settings to other connected cameras.

Apply: Click "Apply" to save settings.

5.4.4 Statistics

Your NVR can retrieve and present statistical data related to object detection when the relevant AI detection features are enabled on the camera. This functionality is crucial for optimizing security measures and understanding activity trends, as it provides key insights from face recognition, pedestrian and vehicle detection, cross counting, and heat maps.

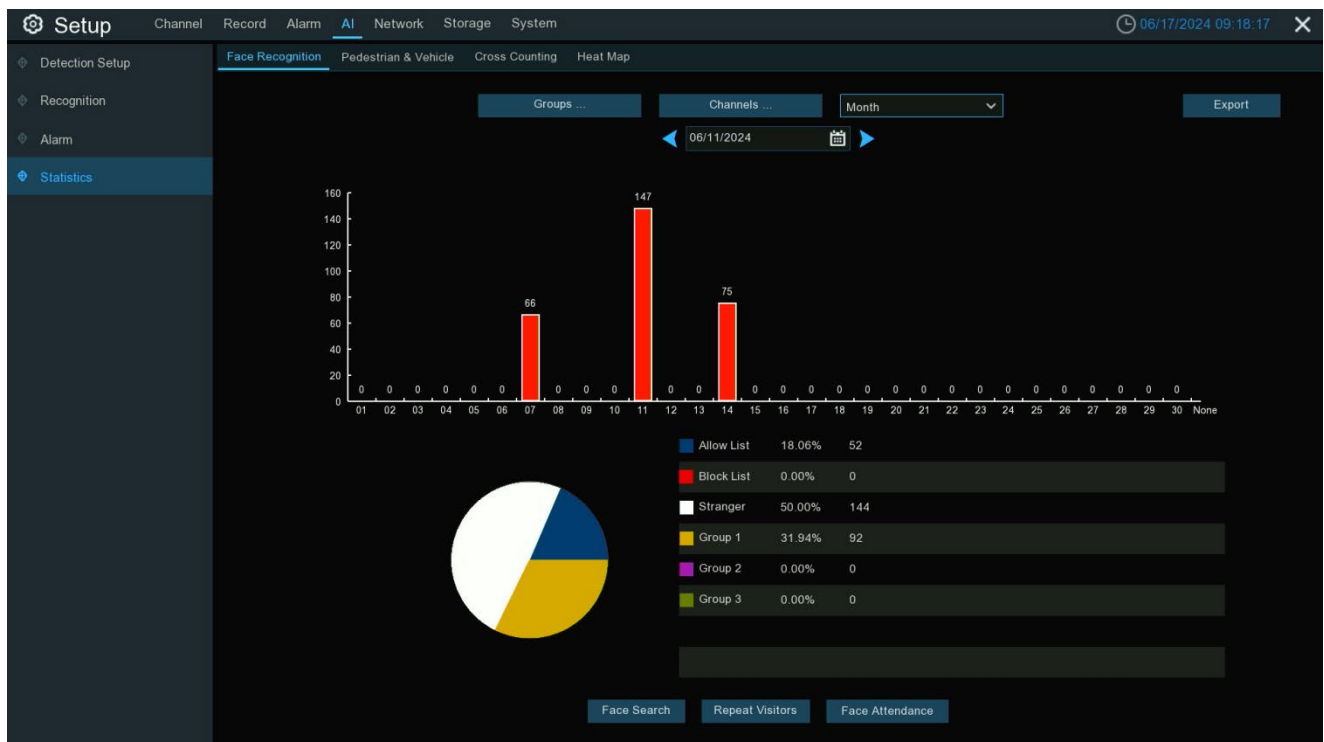

5.4.4.1 Statistics of Face Recognition

You can retrieve and present statistical data related to face recognition when it is enabled on the cameras. It can display bar chart and pie chart for the selected channels, categorized by group, in the form of Day, Week, Month, Quarter, and Year reports



- **Bar Chart:** Displays the number of faces detected during a particular time period.
- **Pie Chart:** Shows the percentage share and frequency of detected faces belonging to each group.

You can generate and export reports through the following menu options:

- **Groups:** Select the groups from which the face recognition data is obtained. By default, all groups are selected.
- **Channels:** Select the channels from which the face recognition data is obtained. By default, all channels are selected.
- **Day/Week/Month/Quarter/Year:** Click the drop-down menu to select the time period for the face recognition data.
- **Calendar:** Change the start date of the selected time period. Click the left or right arrow buttons to move to the previous or next period.
- **Export:** Export the facial recognition data for the selected time period to a USB flash drive. The file will be saved as a *.CSV file, which can be opened in Excel (or similar software) for further analysis.

At the bottom of the page, three quick access buttons related to face recognition are provided: Face Search, Repeat Visitors, and Face Attendance. For detailed instructions on using these features, please refer to section [7.9 AI Search](#) in the manual.

5.4.4.2 Statistics of Pedestrian & Vehicle

In the Pedestrian and Vehicle statistics, you can analyze and present statistics of all detected pedestrians and vehicles over a specific period, visualized in a bar chart format.

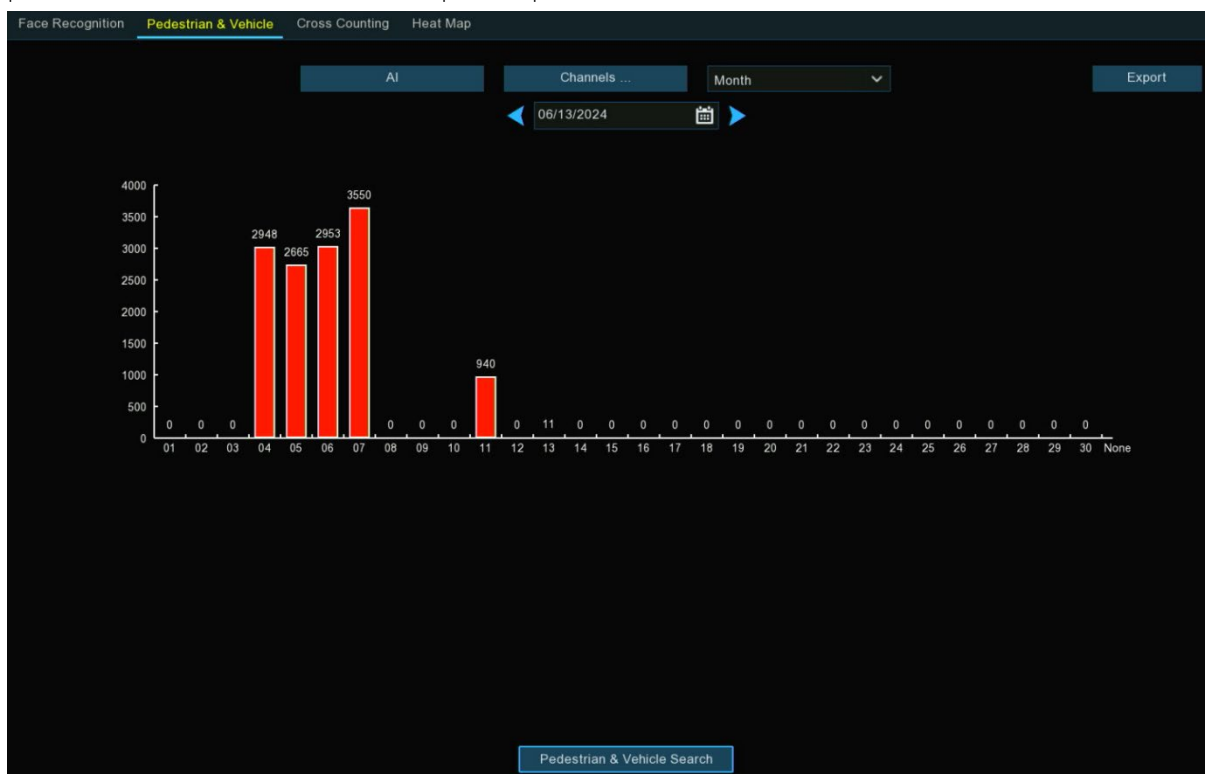

You can generate and export reports through the following menu options:

- **AI:** Select the types of detection related to pedestrian and vehicle detection that you want to query. All options are selected by default.
- **Channels:** Choose the channels from which pedestrian and vehicle detection data will be retrieved. All channels are selected by default.
- **Day/Week/Month/Quarter/Year:** Click the drop-down menu to select the time period for pedestrian and vehicle detection data.
- **Calendar:** Change the start date of the selected time period. Click the left or right arrow buttons to move to the previous or next period.
- **Export:** Export pedestrian and vehicle detection data for the selected time period to a USB flash drive. The file will be saved as a *.CSV file, which can be opened in Excel (or similar software) for further analysis.

At the bottom of the page, you'll find a quick access button for Pedestrian & Vehicle Search. For detailed instructions on using this feature, please refer to section [7.9 AI Search](#) in the manual.

5.4.4.3 Statistics of Cross Counting

If cross counting detection is enabled on the cameras, you can retrieve and analyze statistical data on objects or pedestrians crossing the designated counting lines for each channel.

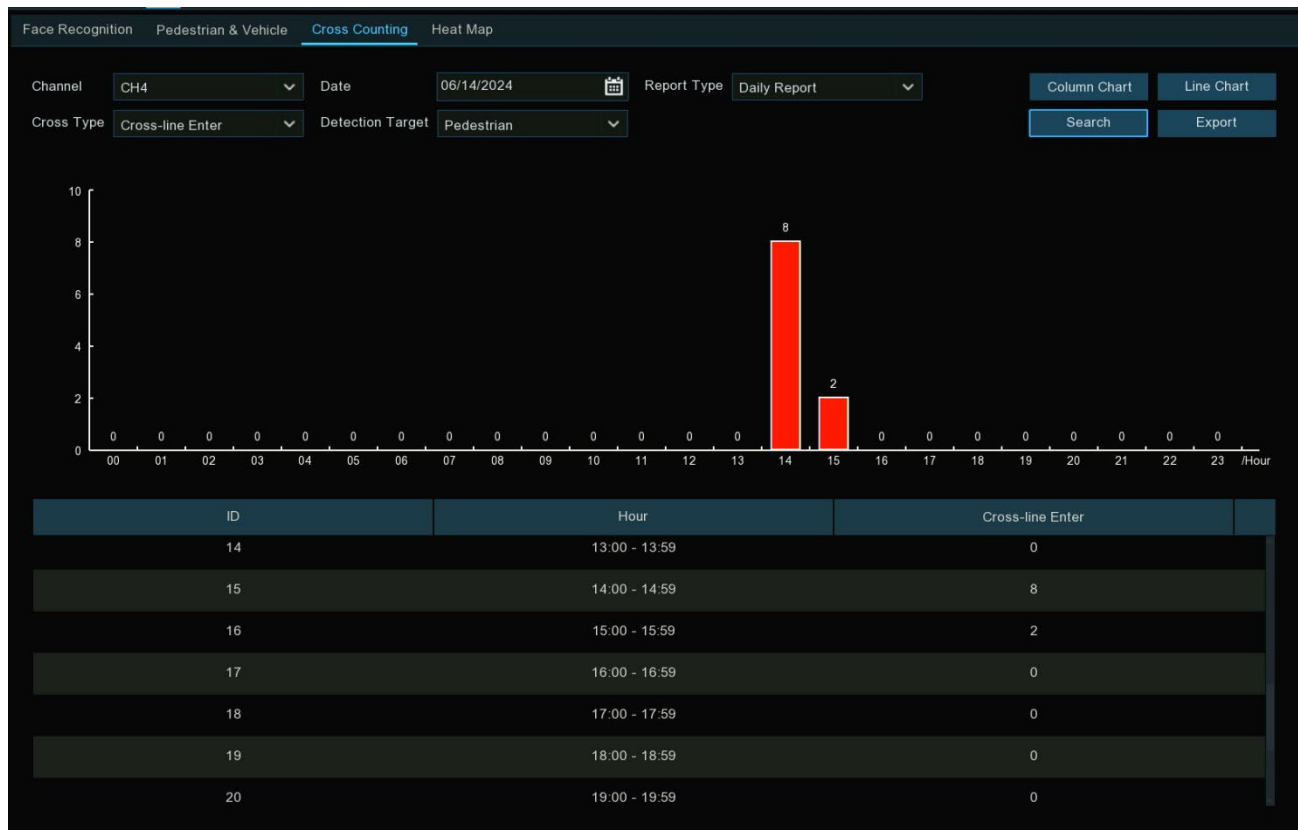

1. Select **Channel** and **Date**: Choose the specific camera channel and date range for your analysis.
2. Specify **Cross Type**: Select either "**Cross-line Enter**" or "**Cross-line Exit**" to determine the direction of movement you wish to analyze.
3. Choose **Detection Target**: Pick from Motion, Pedestrian, Motor Vehicle, or Non-motorized Vehicle to focus on your desired category.
4. Initiate Search: Click the "**Search**" button to generate results, which will be displayed as a column chart by default. For an alternative visualization, click "**Line Chart**" to switch the display mode.
5. Adjust **Report Type**: The system generates a daily report by default. To view broader trends, change the "**Report Type**" to Weekly, Monthly, or Annual, then click "**Search**" again to update the results.
6. Export Data: To save the statistical data for further analysis, click the "**Export**" button. This will save the data as a CSV file on your connected USB flash drive. You can then open this file with spreadsheet software such as Excel for further analysis.

5.4.4.4 Statistics of Heat Map

You can retrieve and visualize statistical data related to object detection when the Heat Map is enabled on cameras. This feature provides a color-coded visual representation of areas and the frequency of detected motion.

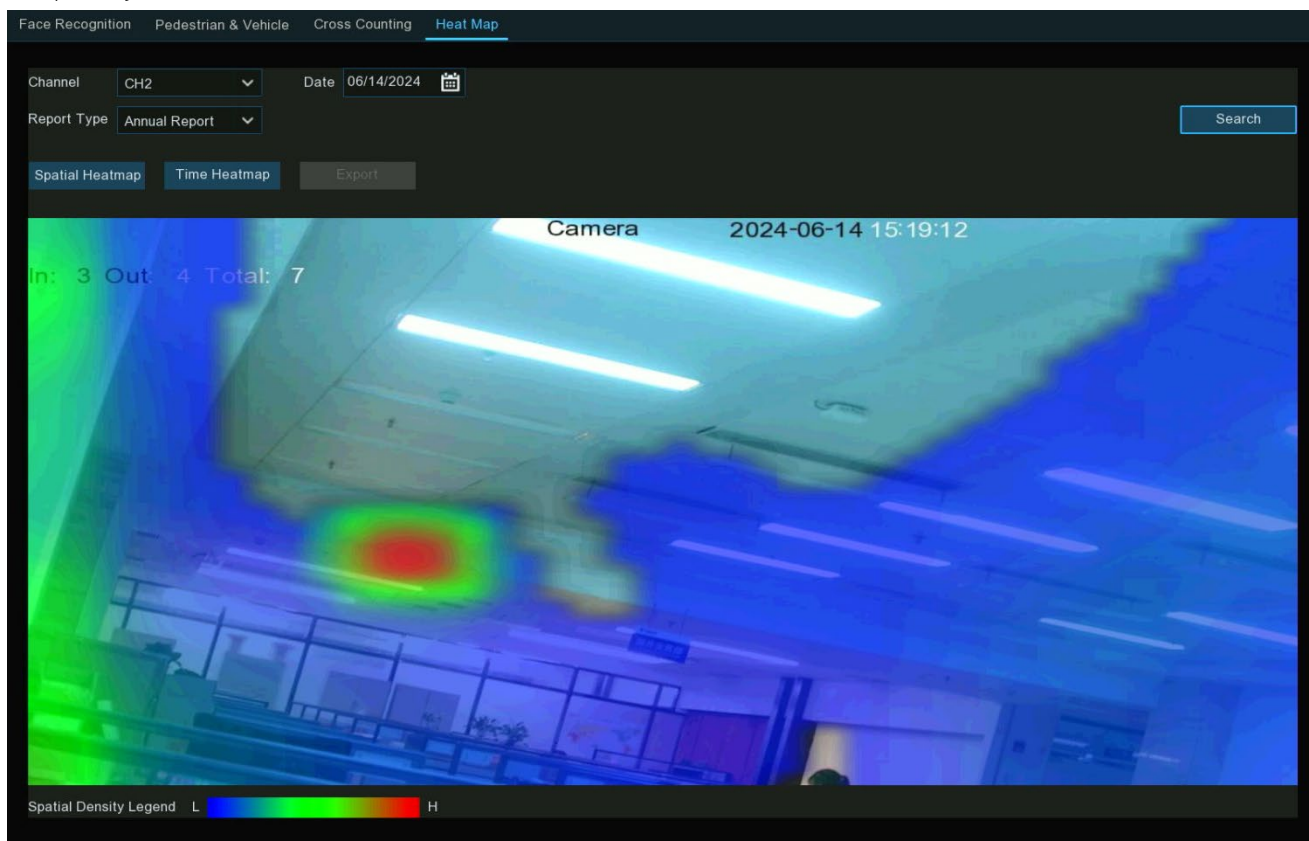

To access and analyze Heat Map statistics:

1. Select **Channel**: Choose the specific camera channel from which you want to obtain heat map data.
2. Choose **Report Type**: Select for a daily, weekly, monthly, or annual report based on your analysis needs.
3. Specify **Time**: Select the relevant time range for your analysis.
4. Select **Date**: Choose the specific date for which you want to analyze the heat map data.
5. Generate Heat Map: Click the "**Search**" button to display the heat map statistics.

The resulting visualization will show a Spatial Density Color map, where each color represents the frequency of detected motion:

- Warm colors (e.g., red, orange) indicate areas with high-frequency motion.
- Cool colors (e.g., blue, green) represent areas with low-frequency motion.

This intuitive display allows you to quickly identify hotspots of activity and understand movement patterns within the monitored area. It can be particularly useful for optimizing camera placement, improving security measures, or analyzing customer behavior in retail environments.

In addition to the heat map, you can also choose to view the data in the form of a bar chart. The bar chart provides a more quantitative perspective, displaying the frequency of activity across different time periods.

To switch to the bar chart view, click the "[Time Heatmap](#)" button on the page, and then click "[Search](#)" again. The height of each bar in the chart will represent the frequency of detected activity, allowing you to visually compare activity levels across different time slots.

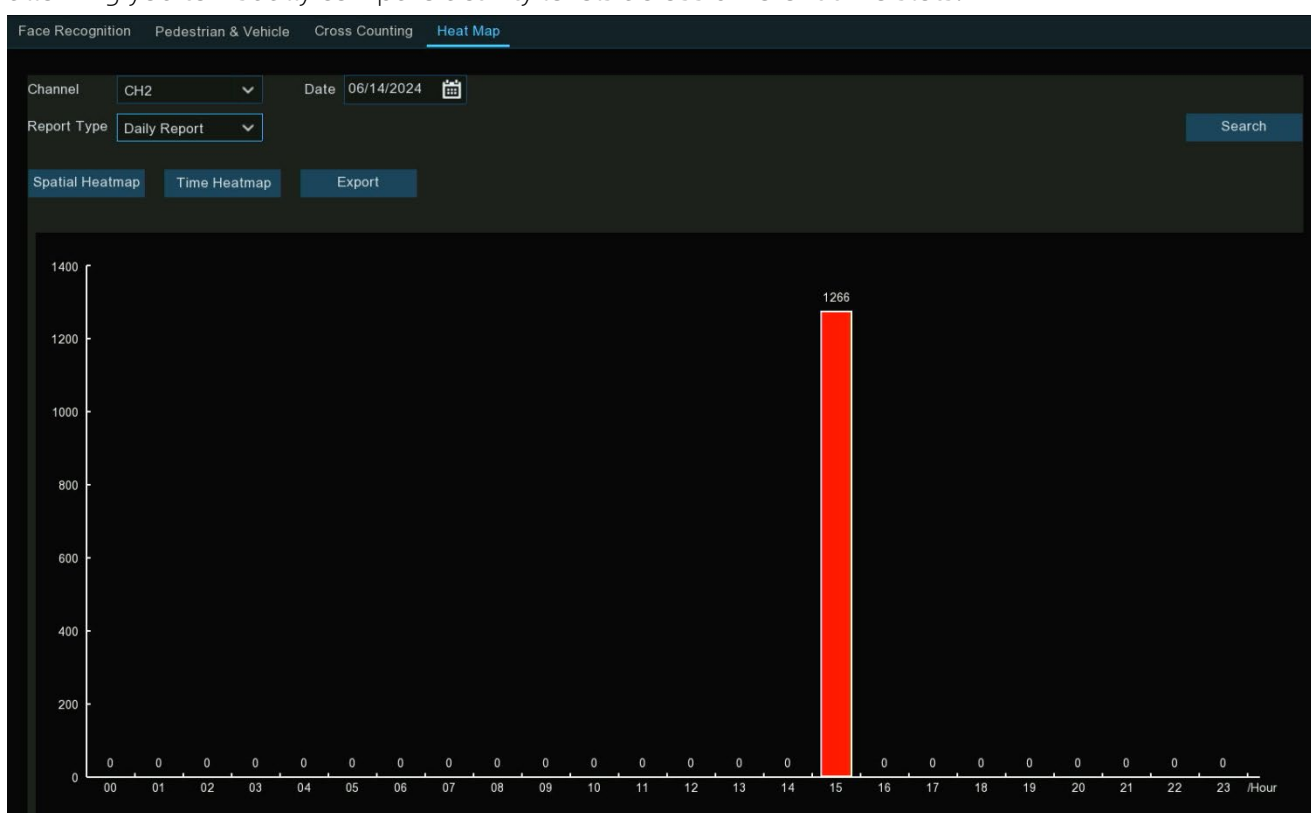

After switching to the bar chart view, you have the option to export the data for further analysis. Click the "[Export](#)" button will save the data as a CSV file on your connected USB flash drive. You can then open this file with spreadsheet software such as Excel for further analysis.

5.5 Network

You can configure network-related settings in this menu.

5.5.1 General Settings

In this menu, you can configure the basic network connection parameters for your NVR.

5.5.1.1 General

In this menu, you can configure the basic parameters of the network interface card (NIC). Depending on the model, there may be configurations with one RJ45 NIC or two RJ45 NICs. Please refer to the following methods for configuration based on the model you have.

1) For devices with a single NIC, please refer to the following configuration method:

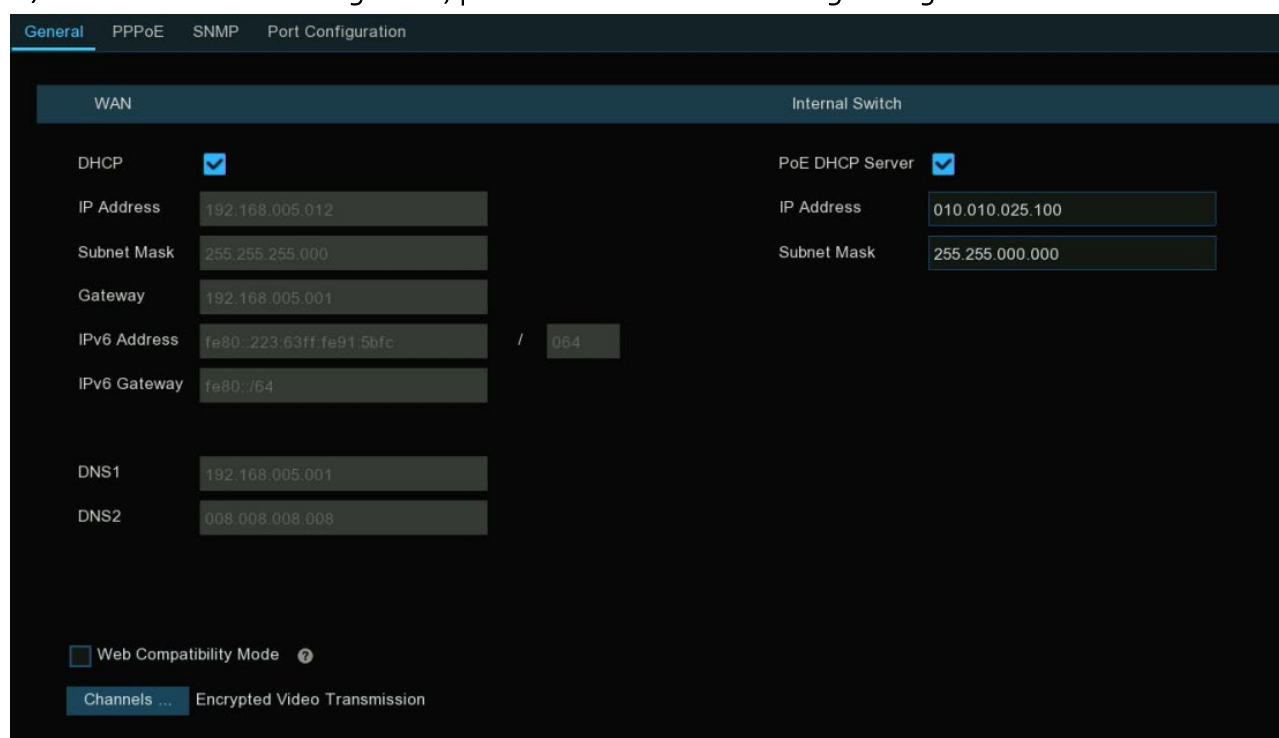

If you connect to a router that supports DHCP (Dynamic Host Configuration Protocol), please tick the checkbox of **DHCP**. The router will automatically assign all the network parameters for your NVR.

When disabling DHCP, the following options can be changed (this is for advanced users only):

- **IP Address:** The IP address identifies the NVR in the network. It consists of four groups of numbers between 0 to 255, separated by periods. For example, "192.168.001.100".
- **Subnet Mask:** This allows the flow of network traffic between hosts to be segregated based on a network configuration. A typical address might be "255.255.255.0" or something similar.

- **Gateway:** This allows your NVR to connect to the internet and is typically the same IP address as your modem or router. The format of the Gateway address is the same as the IP Address. For example, "192.168.001.001".
- **IPv6 Address:** Input the IPv6 IP address if your network service supports IPv6. It consists of eight groups of characters between 0 to FFFF, separated by colons. For example, "ABCD:EF01:2345:6789:ABCD:EF01:2345:6789".
- **IPv6 Gateway:** Input the IPv6 gateway address. The gateway address is used to route traffic from your local network to other networks or the internet, functioning similarly to an IPv4 gateway but using the IPv6 addressing format. For example, "2001:0db8:85a3:0000:0000:8a2e:0370:7334".
- **DNS1/DNS2:** Input the DNS settings for your internet service provider. DNS1 is the primary DNS server and DNS2 is a backup DNS server. Usually, it should be enough just to enter the DNS1 server address.
- **Web Compatibility Mode:** If the selected browser does not support web interface access to login, please enable the web-compatibility mode. Compatible mode will choose the insecure encryption algorithm, please choose carefully.
- **Channels...:** Set the channel encrypt whether transfer video stream to client. Please choose carefully.

If your NVR comes with PoE ports, you will see the internal interface as below:

- **PoE DHCP Server:** Tick the checkbox to enable DHCP service. It will automatically assign an IP address to each IP camera connected to the PoE ports.
- **IP address:** Set the IP address for the internal PoE router. Leave this on the default setting.
- **Subnet Mask:** Leave this on the default setting.

2) For devices with two NICs, please refer to the following configuration method:

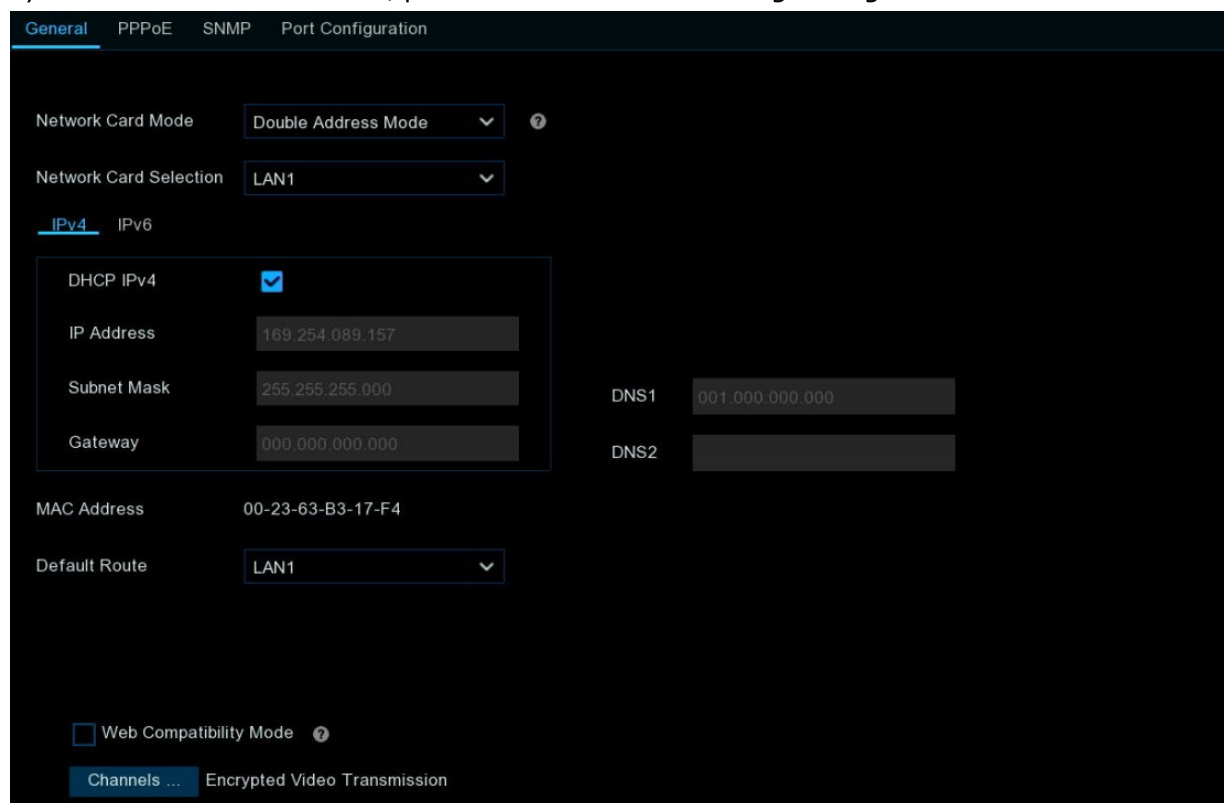

Network Card Mode: Switch between Single Address Mode or Double Address Mode. This determines how the two NICs on the NVR device will operate. Choosing the appropriate mode based on your network environment and requirements can improve network performance, add redundancy backups, and enhance system reliability.

The NVR will restart after a successful switch to apply the new mode settings.

- **Single Address Mode:** In this mode, the two NICs are bound to one IP address. Choosing this mode can increase bandwidth and form a NIC redundancy array, sharing the load. If one NIC fails, another NIC will immediately take over the entire load, and network service will not be interrupted.
- **Double Address Mode:** In this mode, the two NICs are set with different subnet IP addresses, gateways, etc., operating independently. The LAN NIC accessing the external network needs to be set as the default route.

Note:

- 1) In Single Address Mode, connecting to either LAN port allows normal network connectivity. If both LAN ports are connected with network cables, they must be connected to the same switch.
- 2) In Double Address Mode, the two LAN ports cannot be connected to the same switch.

- 3) When selecting Double Address Mode, please ensure the two NICs' IP addresses are not set in the same subnet, otherwise it will cause errors and the network cannot work properly.

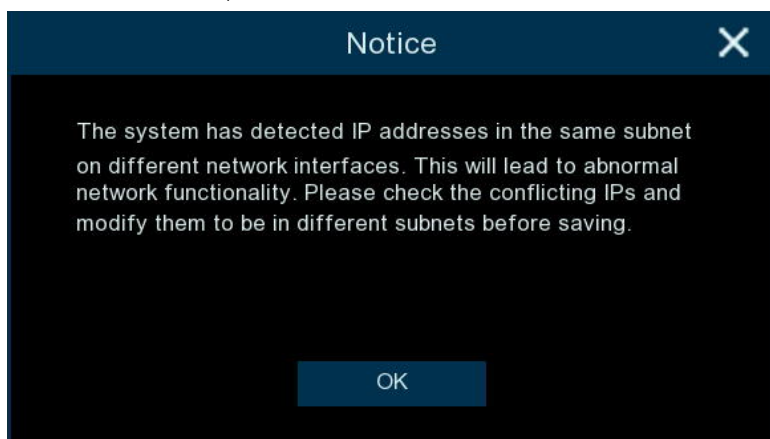

Network Card Selection: Switch to display the network parameter information for LAN1 (NIC1) or LAN2 (NIC2). This option is grayed out and unavailable in Single Address Mode.

For each NIC, you can individually configure its IPv4 and IPv6 settings such as IP address, subnet mask, default gateway, and other parameters.

If you connect to a router that supports DHCP (Dynamic Host Configuration Protocol), please tick the checkbox of **DHCP IPv4**. The router will automatically assign all the network parameters for your NVR. When disabling DHCP, the following options can be changed (this is for advanced users only):

- **IP Address:** The IP address identifies the NVR in the network. It consists of four groups of numbers between 0 to 255, separated by periods. For example, "192.168.001.100".
- **Subnet Mask:** This allows the flow of network traffic between hosts to be segregated based on a network configuration. A typical address might be "255.255.255.0" or something similar.
- **Gateway:** This allows your NVR to connect to the internet and is typically the same IP address as your modem or router. The format of the Gateway address is the same as the IP Address. For example, "192.168.001.001".
- **DNS1/DNS2:** Input the DNS settings for your internet service provider. DNS1 is the primary DNS server and DNS2 is a backup DNS server. Usually, it should be enough just to enter the DNS1 server address.

If your network supports IPv6, click the IPv6 button to configure the following parameters:

The screenshot shows a configuration page for IPv6. At the top left, there are two tabs: 'IPv4' and 'IPv6', with 'IPv6' being the active tab. Below the tabs, there are five input fields arranged in two columns. The left column contains: 'IPv6 Address' with the value '2000:0:0:0:0:0:1', 'Subnet Prefix Length' with the value '064', and 'IPv6 Gateway' with the value '2000:0:0:0:0:0:1'. The right column contains: 'DNS1' with the value '192.168.005.001' and 'DNS2' with the value '008.008.008.008'.

- **IPv6 Address:** Input the IPv6 IP address if your network service supports IPv6. It consists of eight groups of characters between 0 to FFFF, separated by colons. For example, "ABCD:EF01:2345:6789:ABCD:EF01:2345:6789".
- **IPv6 Gateway:** Input the IPv6 gateway address. The gateway address is used to route traffic from your local network to other networks or the internet, functioning similarly to an IPv4 gateway but using the IPv6 addressing format. For example, "2001:0db8:85a3:0000:0000:8a2e:0370:7334".
- **IPv6 Subnet Prefix Length:** Specify the subnet prefix length, which indicates the network portion of the IPv6 address. This is similar to the subnet mask in IPv4 and is typically a number between 1 and 128. For example, a prefix length of 64 means the first 64 bits of the address are the network part.

Default Route: In dual-address mode, set the LAN port connecting to the external network as the default route..

Web Compatibility Mode: If you are unable to access the device via the web, you can enable this mode to try to resolve the issue. (Note: Enabling this mode uses insecure encryption, so proceed with caution.)

Encrypted Video Transmission: The system supports encrypting video transmitted over the network. Click the "**Channels...**" button to select the channels you want to encrypt. By default, all channels are selected. If you are not an expert in this area, please keep the default settings.

5.5.1.2 PPPoE Settings

Enable PPPoE networking, the device can connect to the network via dial-up.

Enable PPPoE: Set the "Enable PPPoE" switch to the enabled state. This will allow the NVR to connect to the network via a dial-up connection using PPPoE.

PPPoE Network Card Select: If your device has NICs, select the appropriate LAN port that you want to use for the PPPoE dial-up connection.

Note: If your device has only a single NIC, this option will not be available.

User: PPPoE user name.

Password: PPPoE password.

5.5.1.3 SNMP

Users can obtain NVR parameters and receive alarm information from the NVR through the SNMP (Simple Network Management Protocol) protocol.

Note:

- Before setting SNMP parameters, users need to download SNMP software to receive NVR information through the SNMP port, such as software version number, device type, channel IP, resolution, frame rate, etc.
- Set the Trap management address, and the NVR can send alarm and exception information to the management station.

SNMP Version: Select the SNMP version to use, common options are v1, v2c, and v3. Different versions have different security levels and features.

SNMP Port: Specify the port number the NVR uses for SNMP communication, typically defaults to 161.

Read Community: The read community string, used to authorize SNMP management stations that can read data from the NVR. It must match the value set on the management station.

Write Community: The write community string, used to authorize SNMP management stations that can write data to the NVR. It must match the value set on the management station.

Trap IP Address: Specify the IP address of the SNMP management station that will receive SNMP trap messages (such as alarm notifications) sent by the NVR.

Trap Port: Specify the port number for receiving SNMP trap messages, typically 162.

After correctly configuring these parameters, the NVR can communicate with compatible SNMP management software. The management software can read status information from the NVR and receive trap message notifications when the NVR encounters exceptions. This helps promptly detect and respond to system issues.

Note that for security reasons, the Read/Write Community strings should not use default values, and Traps should only be sent to trusted management stations.

5.5.1.4 Wireless Connection

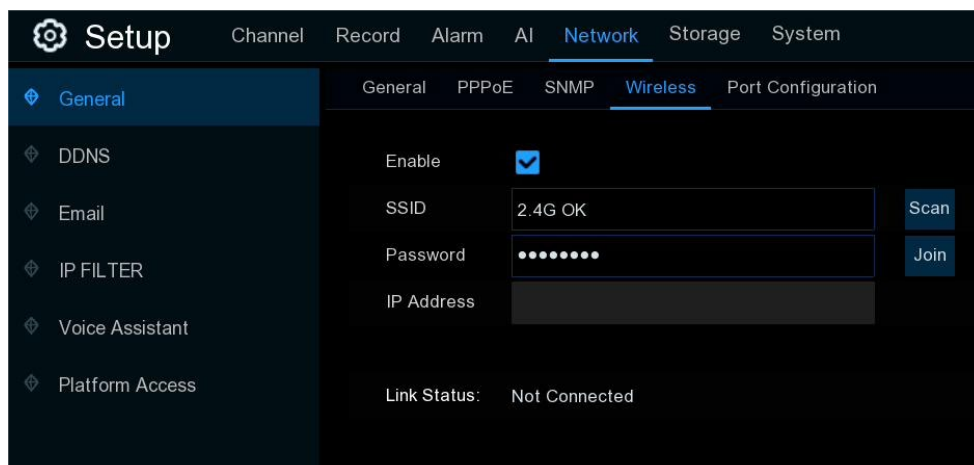

Some NVR models support accessing the internet by connecting to a wireless Wi-Fi dongle. When the Wi-Fi dongle is inserted, users can connect to a Wi-Fi network through the configuration page. Ensure the Wi-Fi dongle is plugged into an available USB port on the NVR. This will allow accessing the Wi-Fi configuration tab/page. Disconnect any Ethernet cable from the NVR's Ethernet port if currently connected.

1. Check the "Enable" checkbox to activate the Wi-Fi connection.
2. Click the "Scan" button. After a short moment, a list of Wi-Fi access points detected by your NVR will be shown. If the access point you want to connect to is not shown in the list, click the "Update" button to scan again.

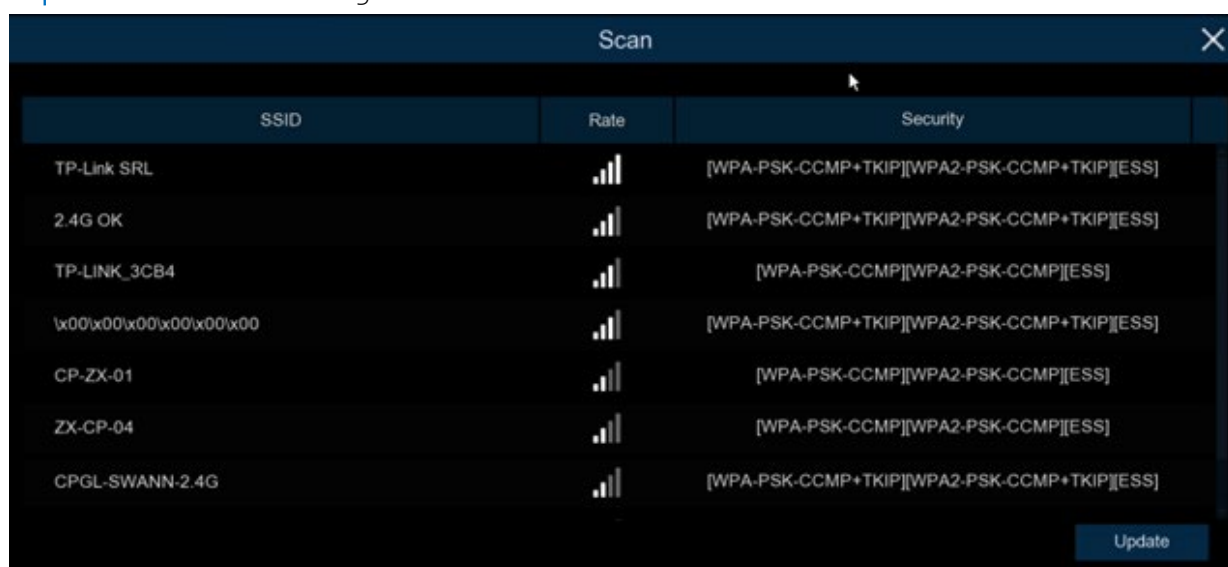

3. Enter the password for your Wi-Fi access point, then click the "Join" button. Ensure the password is correct before proceeding
4. Initiate the Wi-Fi connection by clicking Join or Connect after entering the password.
5. The NVR will attempt to connect to the Wi-Fi network. If successful, the Wi-Fi link status will show as connected.
6. After a short moment, your NVR will connect to your Wi-Fi access point. Click "OK" to continue. If the connection has failed, check that the password is correct. The Link Status will change to "Connected," showing a successful connection. Click "Apply" to save the settings.

5.5.1.5 Port Configuration

This menu is primarily used to set the port numbers for the NVR to connect and be accessed from external networks. Correctly configuring these ports is crucial to ensure the NVR can be properly accessed and controlled over the local network or the internet.

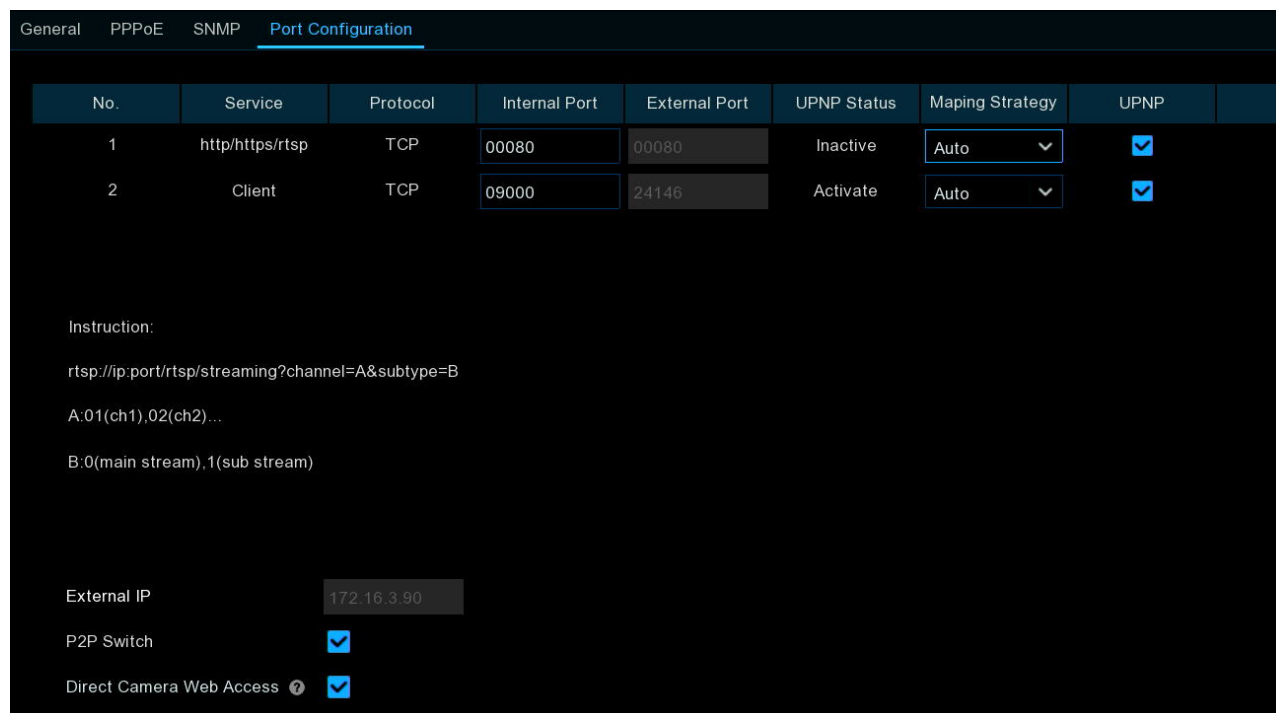

No.	Service	Protocol	Internal Port	External Port	UPNP Status	Mapping Strategy	UPNP
1	http/https/rtsp	TCP	00080	00080	Inactive	Auto	<input checked="" type="checkbox"/>
2	Client	TCP	09000	24146	Activate	Auto	<input checked="" type="checkbox"/>

Instruction:
 rtsp://ip:port/rtsp/streaming?channel=A&subtype=B
 A:01(ch1),02(ch2)...
 B:0(main stream),1(sub stream)

External IP: 172.16.3.90
 P2P Switch:
 Direct Camera Web Access:

The NVR mainly contains two types of ports for different connection and data interaction methods:

- **http/https/rtsp:** This port is used to log into the NVR via a web browser or access video streams using the RTSP protocol from third-party players. The default is usually 80, but it can be changed if that port is already used by another device on the network.
- **Client:** An internal port (default 9000) that the NVR uses to send out information for data transfer and communication. It usually does not conflict with other devices unless you have another NVR-like device on the same network.

Each type of port includes an Internal Port and an External Port, whose roles are as follows:

- **Internal Port:** Mostly used for the NVR to communicate and exchange data with other devices on the local network (LAN). For example, the NVR sends video streams to computer client software or mobile apps on the same LAN. Only devices within the same LAN can access the NVR through the Internal Port.
- **External Port:** Mostly used to access and connect to the NVR from different networks, such as the internet. Requires port forwarding on the router to associate the external port with the NVR's internal port. Only after correctly configuring the external port and port forwarding can external

users remotely access the NVR. Incorrect external port configuration may prevent access to the NVR from the internet.

To perform port forwarding for the External Port, you can select **Manual** or **Auto** in the "**Mapping Strategy**". If you choose the manual mode, you need to manually enter an External Port number, and then set up port forwarding for this port on your router that the NVR is connected to. If your router supports the UPnP feature, you can also select the Auto mode and check the UPnP option. Then the router will automatically provide an External Port for the NVR and forward it automatically.

External IP: Showing the current external (public) IP address of the NVR.

P2P Switch: When turned off, users will not be able to access the device using the P2P ID.

Direct Camera Web Access: When enabled, it allows direct access to the IP cameras' web pages via hyperlinks from the NVR's web interface.

5.5.2 DDNS

This menu allows you to configure DDNS settings. DDNS provides a static address to simplify remote connection to your NVR. To use DDNS, you first need to create an account on the website of a DDNS service provider.

The screenshot shows the 'Setup' interface with the following elements:

- Top Navigation:** Setup, Channel, Record, Alarm, AI, Network (selected), Storage, System.
- Left Sidebar:** General, DDNS (selected), Email, IP FILTER, Voice Assistant, Platform Access.
- DDNS Configuration:**
 - DDNS:**
 - Server:** NO_IP (dropdown menu)
 - Hostname:** [Empty text field]
 - User:** [Empty text field]
 - Password:** [Empty text field]
 - Test:** [Button]

DDNS: Enable or disable DDNS.

Server: Select your preferred DDNS server (DYNDNS, NO-IP, CHANGEIP, DNSEXIT).

Domain: Enter the domain name you created on the DDNS service provider's website. This is the address you'll use in the URL when connecting remotely to the NVR via PC.

User/Password: Enter the username and password you obtained when creating an account with the DDNS service provider.

After entering all parameters, click "Test" to verify the DDNS settings. If the test result is "Network unreachable or DNS error", please check if your network is functioning normally and if the DDNS information is correct.

Once you've set up DDNS, you can access the NVR remotely through the domain name using a web browser, in the format `http://[applied domain name]:[mapped HTTP port number]`. When using a DDNS domain name to access the NVR, ensure that the port and current IP are accessible on the public network for a successful connection. The server address, hostname, username, password, and settings should match those on the NVR.

Note:

DNSEXIT has updated their integration protocols. The new protocol no longer supports username and password authentication. Instead, you need to log into your account on their official website and obtain an authentication key (e.g., `yUS5qMHQuPljr4jHtoMuXDO883BqsO`).

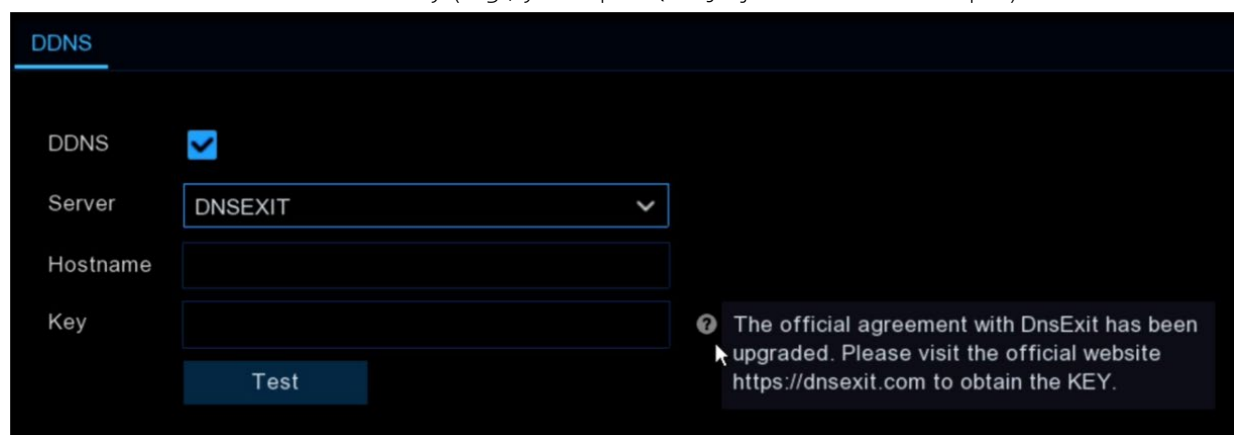

The old version authenticated by password. If a device using the old version experiences an external IP change, the DNSEXIT domain name will cease to function. You must update to version 8.2.4.1 or later, obtain a new key from the DNSEXIT website, and reconfigure the domain name for it to work properly.

5.5.3 Email Settings

This menu allows you to configure email parameters. Please complete these settings if you want to receive system notifications via email when events occur. Additionally, a properly configured email is essential for password reset procedures, so it's important to set this up accurately.

5.5.3.1 Email Configuration

The screenshot shows the 'Email Configuration' page in the NVR Setup interface. The page is part of the 'Network' tab under 'Setup'. The left sidebar shows 'Email' selected. The main area has two tabs: 'Email Configuration' (active) and 'Email Schedule'. The configuration fields include:

- Email:**
- Encryption:** SSL
- SMTP Port:** 00587
- SMTP Server:** smtp.gmail.com
- User Name:** [redacted]@gmail.com
- Password:** [masked with dots]
- Sender's Name:** NVRTeseter
- Receiver 1:** [redacted]@gmail.com
- Receiver 2:** [empty]
- Receiver 3:** [empty]
- Interval:** 3 Min

A **Test** button is located at the bottom of the configuration area.

Email: Check this box to enable email notifications.

Encryption: Enable if your email server requires SSL or TLS verification. If unsure, select Auto.

SMTP Port: Enter the SMTP port of your email server.

SMTP Server: Enter the SMTP server address for your email service.

User Name: Enter your email address.

Password: Enter the password for your email account.

Receiver 1~3: Input up to three email addresses to receive email alerts.

Interval: Set the minimum time that must elapse between email alerts. Adjust as needed..

To verify your settings, click **Test Email**. The system will send an automated email to your inbox. If you receive the test email, your configuration is correct.

5.5.3.2 Email Schedule

By default, if email alerts are enabled on your NVR, they will be sent 24 hours a day. You can customize this schedule to determine when your NVR sends these alerts. For example, you may prefer to receive alerts only during daytime hours. You can create a unique schedule for each camera.

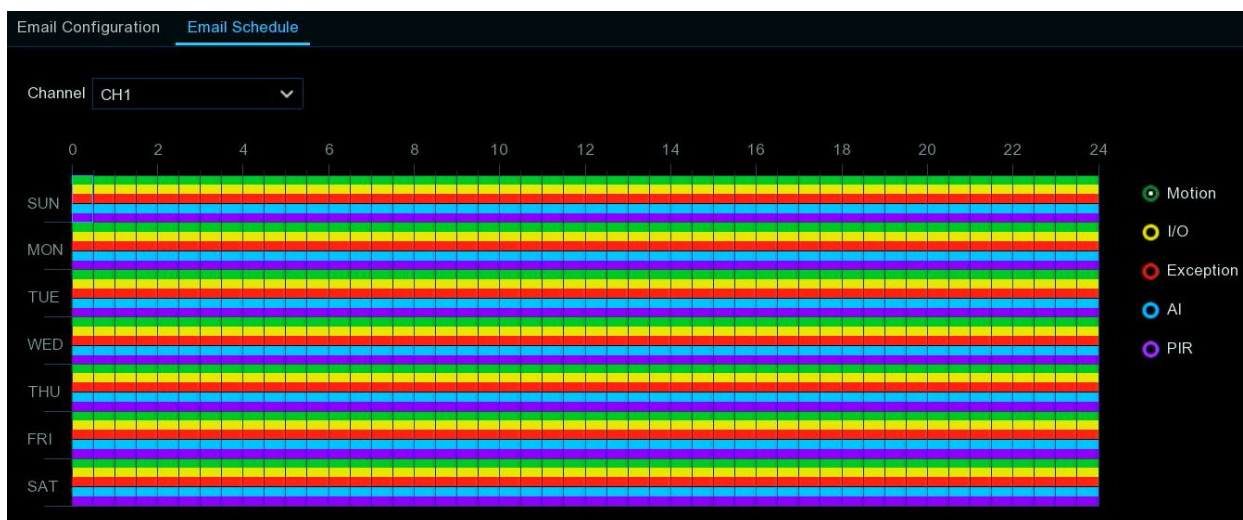



1. Select a channel you want to set the schedule.
2. Click the radio button for the alarm type you want to schedule email alerts:
 - **Motion:** Email alerts for motion detection events
 - **IO:** Email alerts for I/O triggered events
 - **Exception:** Email alerts for exception events which include no space left on the hard drive, a hard drive error or if one of the channels has lost the feed from its camera.
 - **AI:** Email alerts for AI-related events
 - **PIR:** Email alerts for PIR events
3. Using your mouse, click on a time block to change its status, or click and drag across multiple blocks to set your desired time period.
4. Repeat steps 2 & 3 to set schedules for other alarm types.
5. The schedule you set applies only to the selected channel. To apply the same schedule to other channels, use the **Copy** function.
6. Click **Apply** to save your settings.

5.5.4 IP FILTER

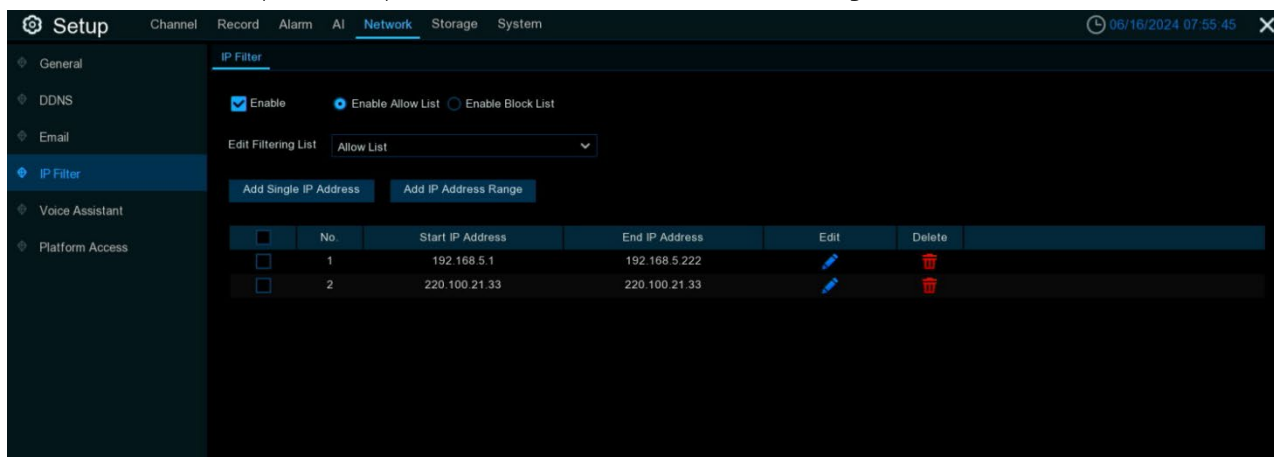

IP Filtering is an effective method to control access to your network devices for specific groups of IP addresses. By using IP Filters, you can set up allow lists of trusted IP addresses to access the device, or use block lists to prohibit specified IP addresses from accessing the device.



Allow List: This list defines IP addresses that are permitted to access your NVR, preventing unauthorized IP addresses from logging in. To create and edit the Allow List:

- Tick the checkbox of "Enable" to activate the IP filter function.
- choose "Allow List" from the dropdown menu of "Edit Filtering List". The interface should now display the current Allow List for editing.
- To add individual IP addresses, click "Add Single IP Address" and enter the IP. To add a block of IP addresses, click "Add IP Address Range" and input the start and end IP addresses.
- You can click the edit button  or delete button  to edit or remove the corresponding list. You can also select multiple entries in the list by checking the boxes next to them, and then use the "Remove List" button at the bottom of the page to delete them in bulk.
- Click "Save" to save your changes.

Block List: This list defines IP addresses that are forbidden from accessing your NVR, preventing unauthorized access. To create and edit the Block List:

- Tick the checkbox of "Enable" to activate the IP filter function.
- choose "Block List" from the dropdown menu of "Edit Filtering List". The interface should now display the current Block List for editing.
- To add individual IP addresses, click "Add Single IP Address" and enter the IP. To add a block of IP addresses, click "Add IP Address Range" and input the start and end IP addresses.
- You can click the edit button  or delete button  to edit or remove the corresponding list. You can also select multiple entries in the list by checking the boxes next to them, and then use the "Remove List" button at the bottom of the page to delete them in bulk.

- Click "[Save](#)" to save your changes.

When you have finished setting up the Allow List and Block List, click either "[Enable Allow List](#)" or "[Enable Block List](#)" to activate the IP Filter function. Please note that the system can only execute either the Allow List or the Block List at any given time, not both simultaneously.

5.5.5 Voice Assistant

The voice assistant function allows to connect your NVR to your GoogleCast or Amazon Fire TV Stick, and cast the real-time surveillance images on your TV monitor by voice control.

5.5.5.1 Amazon

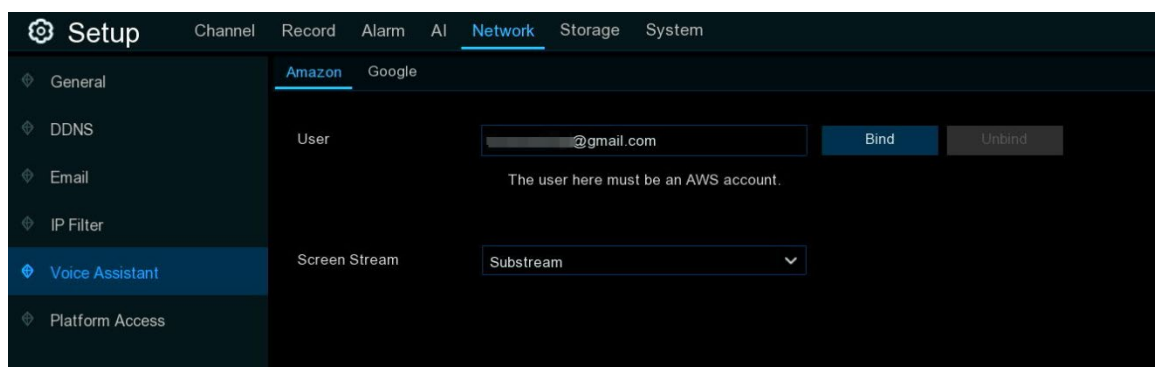

1. Enter your Amazon account and click the "[Bind](#)" button to link your Amazon account. Then select the video stream you want to cast on your TV.
2. Go to Channel -> Live menu, and assign easy-to-call names to the channel(s) you want to cast on your TV.

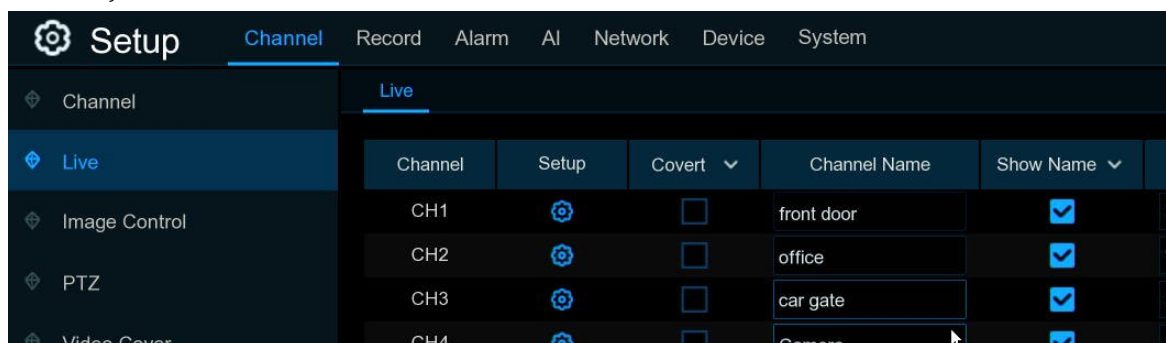

3. Connect the Fire TV Stick to your TV and power it on. Ensure the Fire TV Stick is connected to the same Wi-Fi network as your NVR.

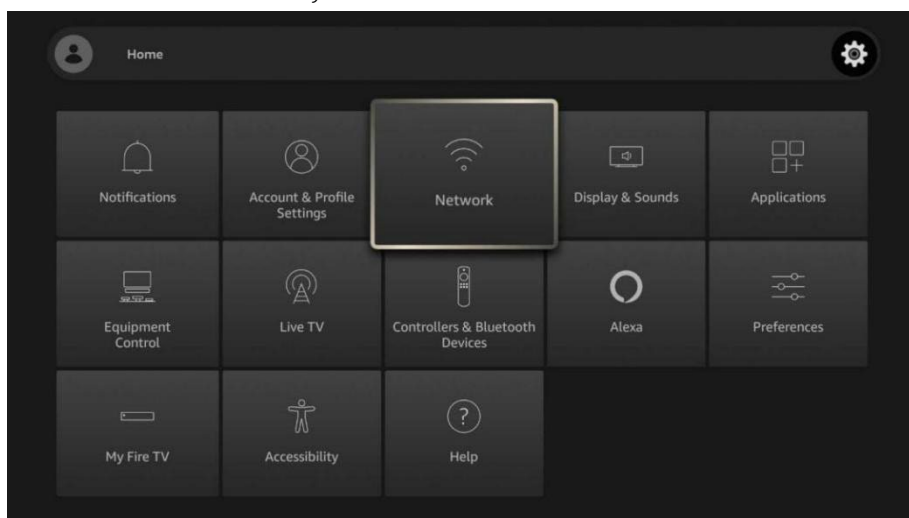

4. On the Fire TV Stick, use your existing profile or add a new one, and log in with the same Amazon account you linked to the NVR.

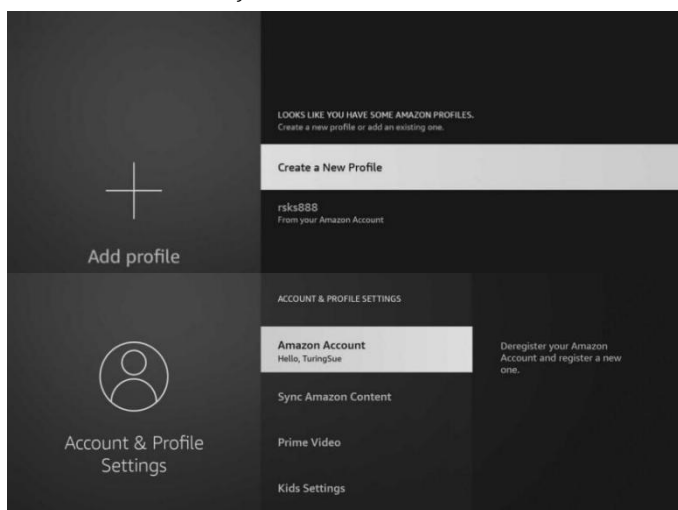

5. Search for and install the Amazon Alexa app on your mobile phone, then log in with the same Amazon account you linked to the NVR.

A screenshot of the Amazon Alexa app's sign-in screen. At the top is the Amazon Alexa logo. Below it is the title 'Sign-In' and a link for 'Forgot password?'. There are two input fields: 'Email (phone for mobile accounts)' and 'Amazon password'. Below the password field is a checkbox labeled 'Show password'. At the bottom is a blue button with the text 'SIGN-IN'. At the very bottom, there is a line of text: 'By continuing, you agree to Amazon's [Conditions](#)'.

6. Touch "More", and then tap "Skills & Games".

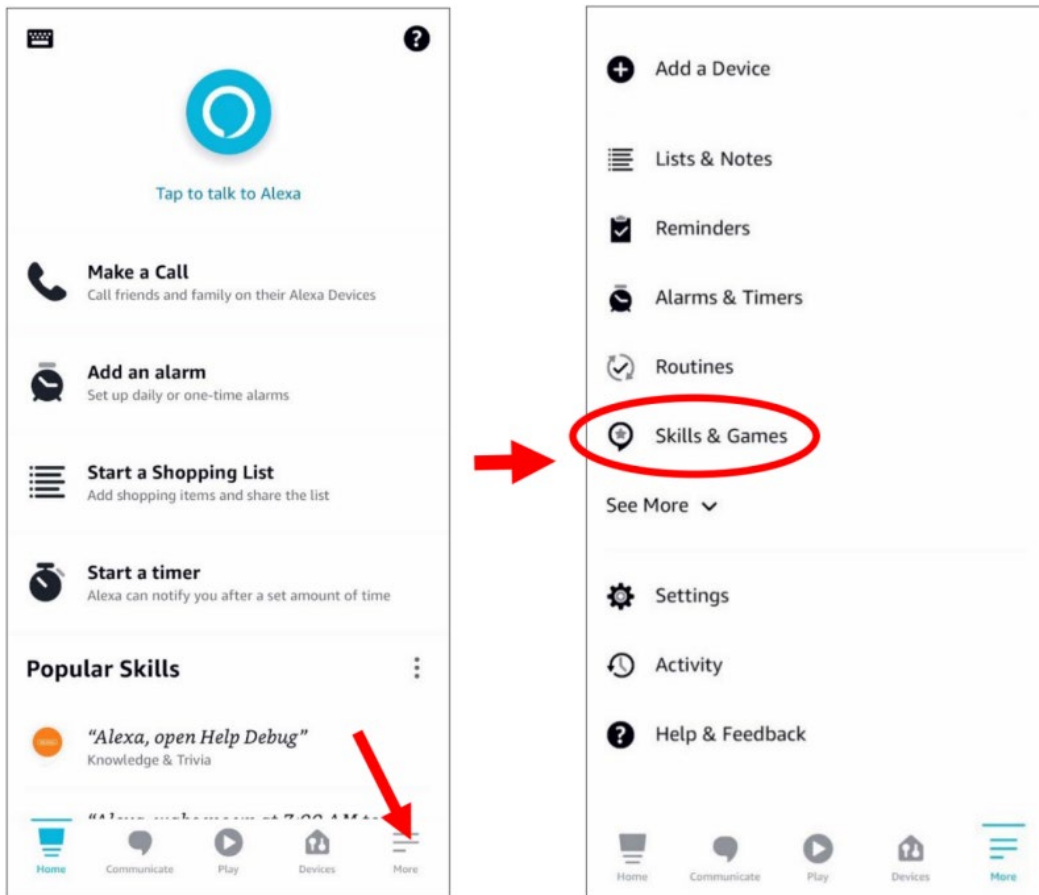

7. Tap the search icon in the top right corner.

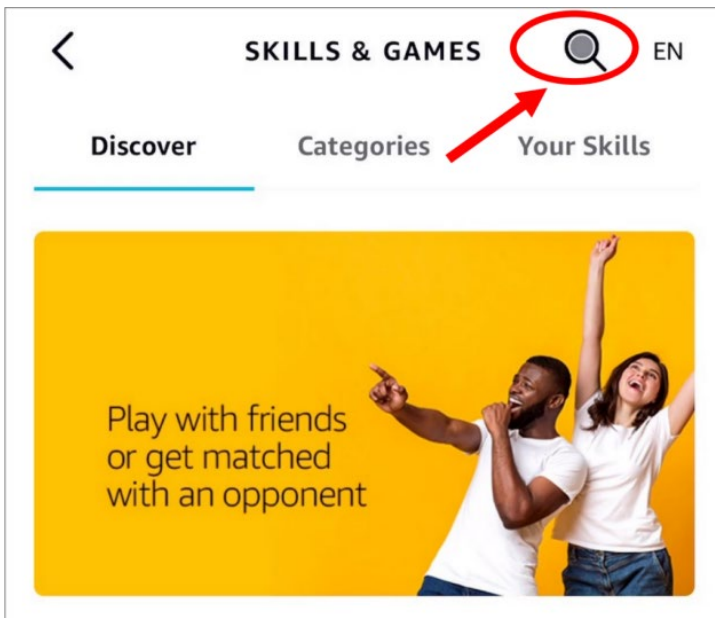

8. Enter the keyword "smart camera view" and search.

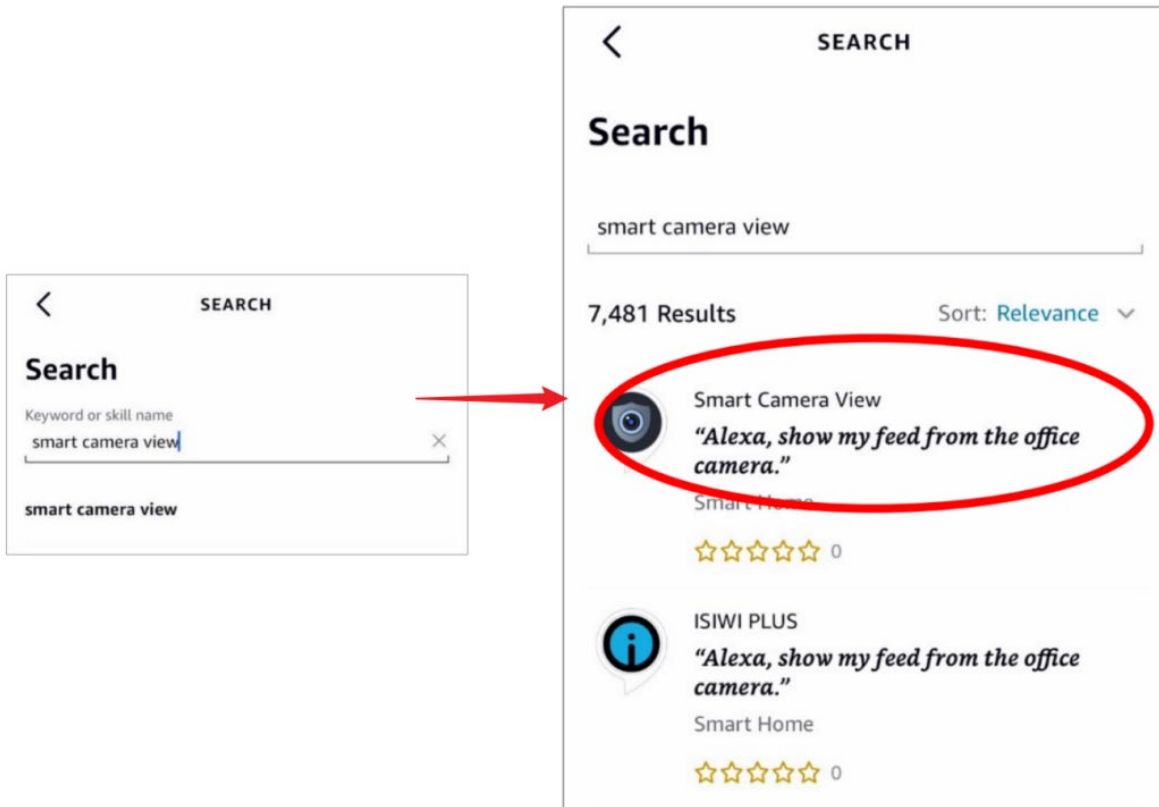

9. Tap the "Smart Camera View" app in the search results. Then tap "ENABLE TO USE".

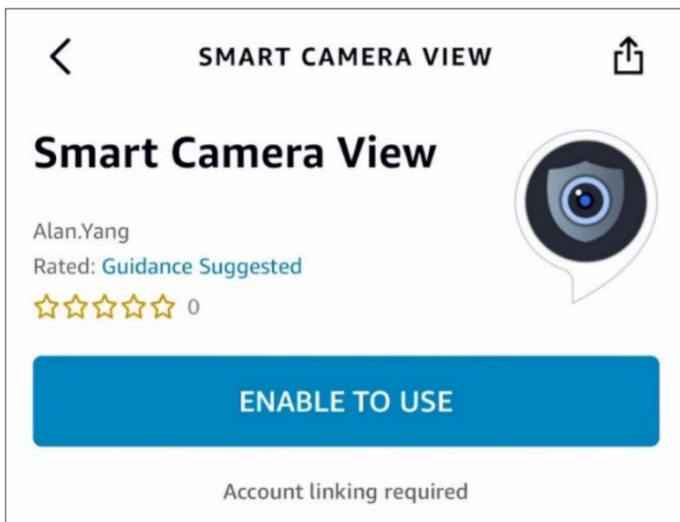

10. Link your Amazon account by signing in with the same account you linked to the NVR. Tap "Done" after successfully linking the skill.

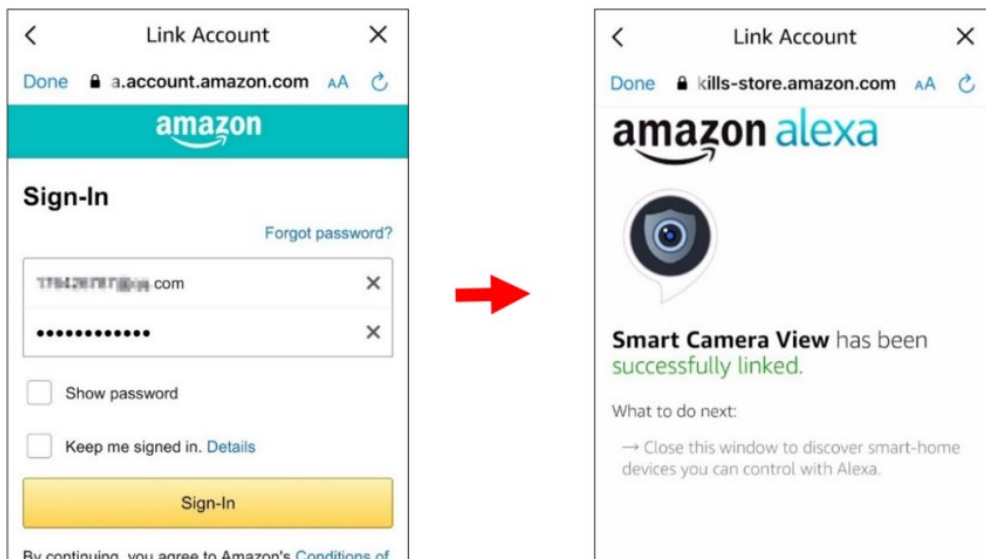

11. Tap "DISCOVER DEVICES" and wait for the app to find the cameras. Tap "Next" when the devices are found and connected

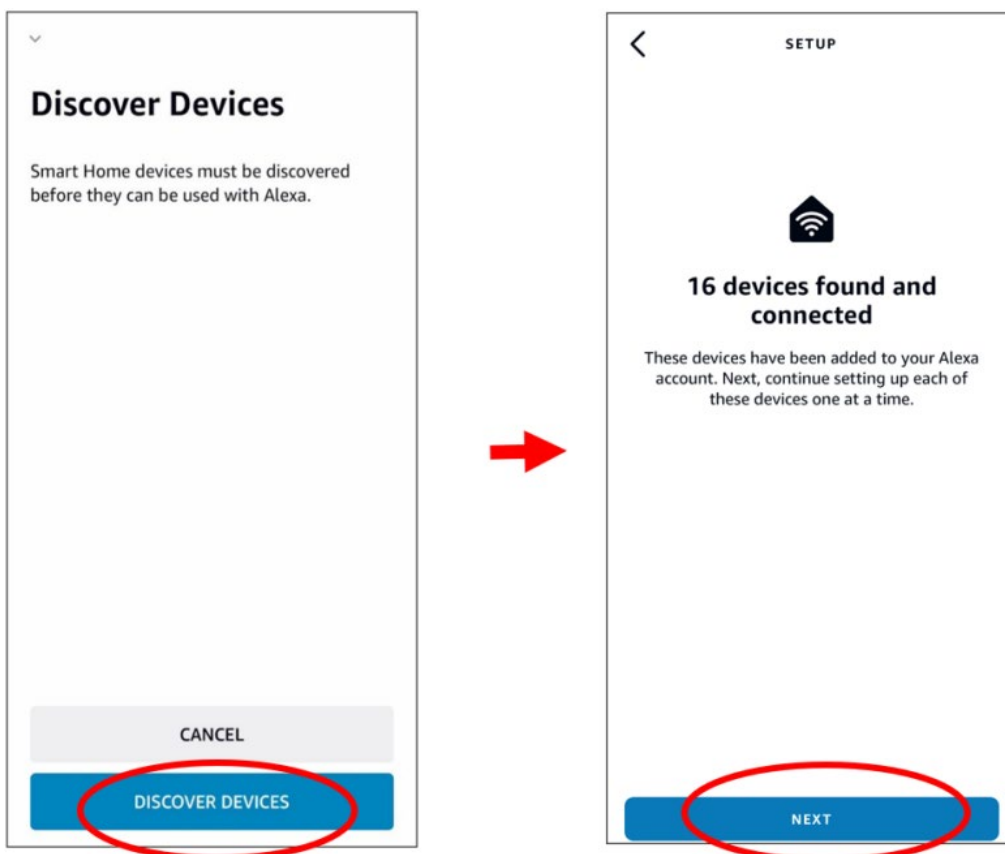

12. Choose a device and tap "SET UP DEVICE". You can add the camera to a group or skip this step.

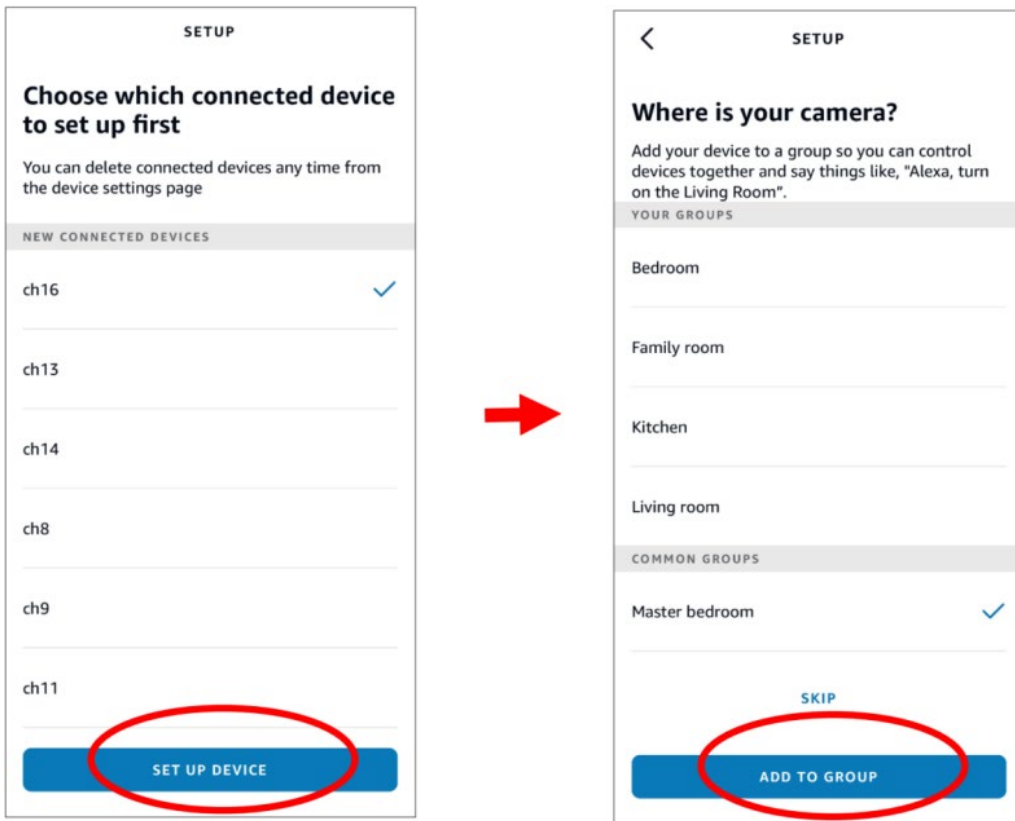

13. Repeat step 12 for all cameras, then tap "Done" to finish.



14. All added cameras will be listed under Devices. Tap the "Cameras" icon to view all added cameras.

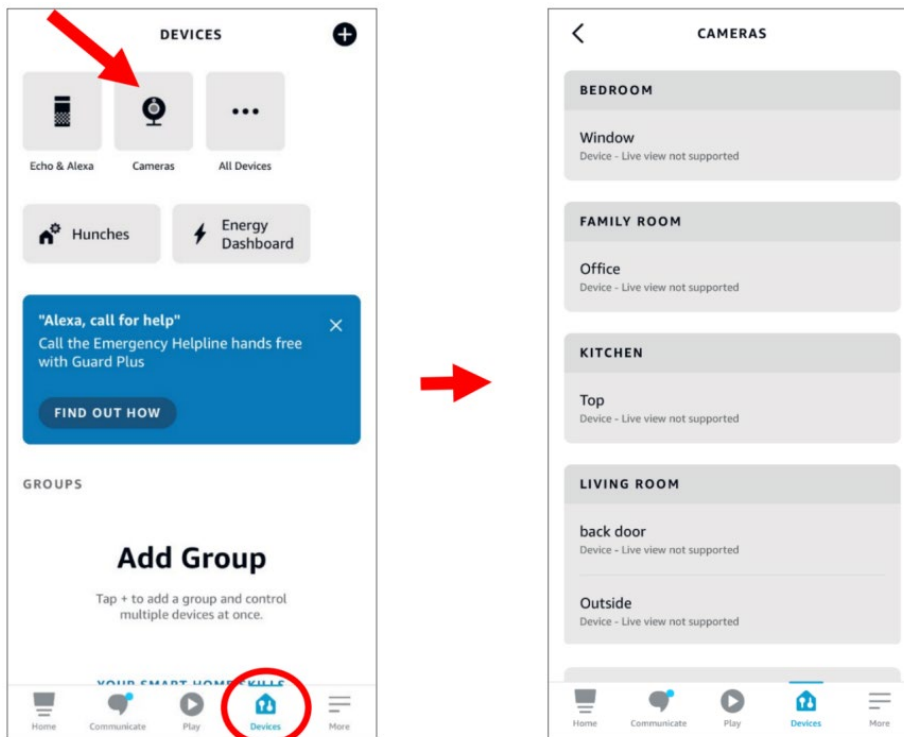

15. Press and hold the voice button on the Fire TV Stick remote and speak your command clearly. For example, say "Show the [camera name]" or "Show [camera name]". If your camera is named "Office", you could say "Show my office camera"

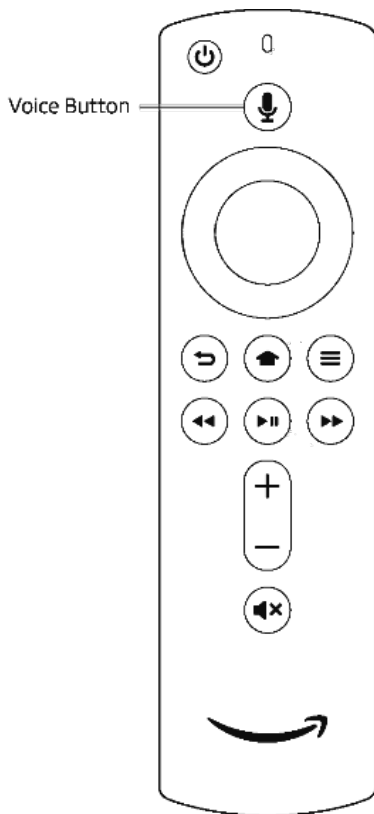

16. Shortly, you should see real-time images from the requested camera on your TV.

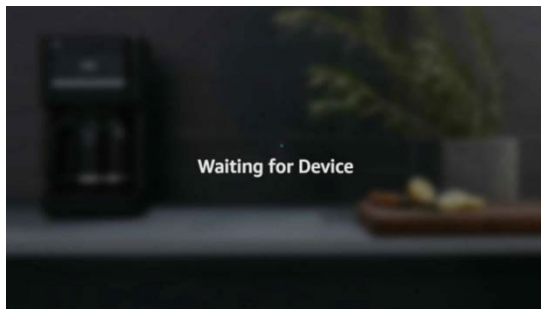

17. To exit the camera live view, say "Stop".
18. If you change a channel's name, you'll need to rediscover and add that camera again.

5.5.5.2. Google

1. Enter your Google account and click the "Bind" button to link your Google account. Then select the video stream you want to cast on your TV.

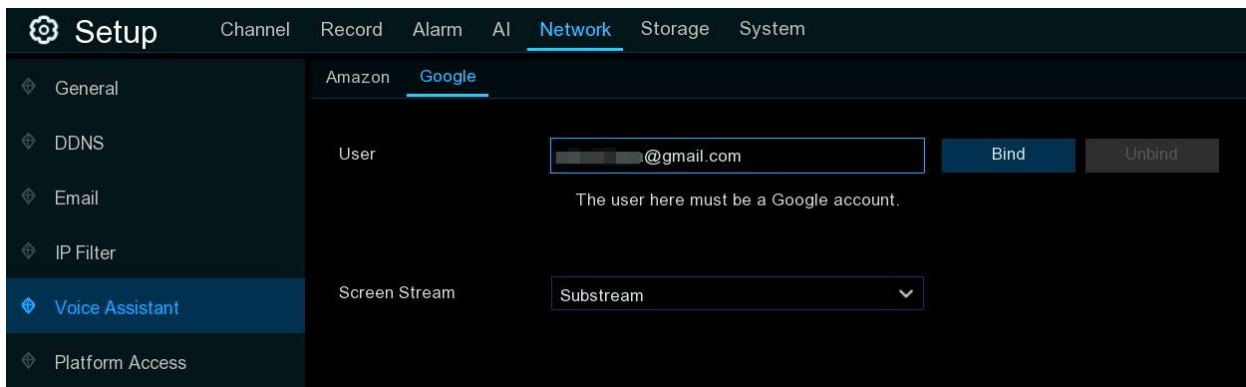

2. Go to Channel -> Live menu, and assign easy-to-call names to the channel(s) you want to cast on your TV.

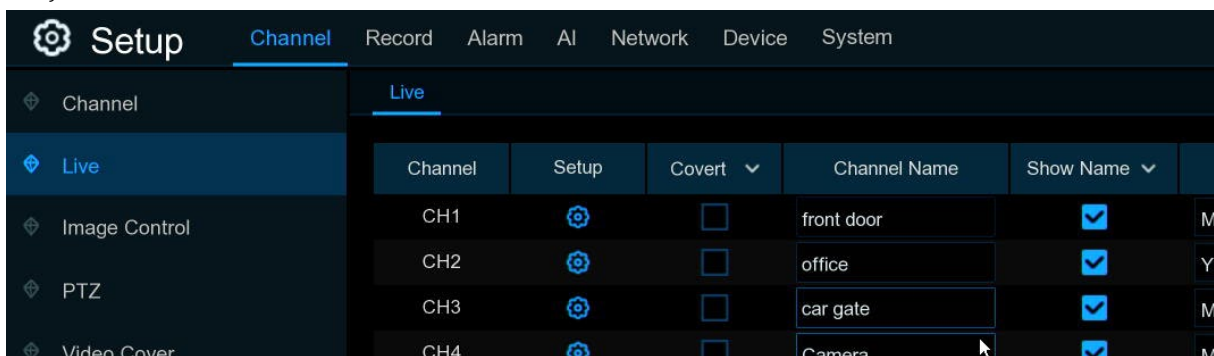

3. Connect the Chromecast to your TV monitor and power it on.

- Search for and install the Google Home app on your mobile phone from the app store. Run the installed Google Home app, tap "OK" to allow the app to use your local network and Bluetooth, and then tap "Get Started".

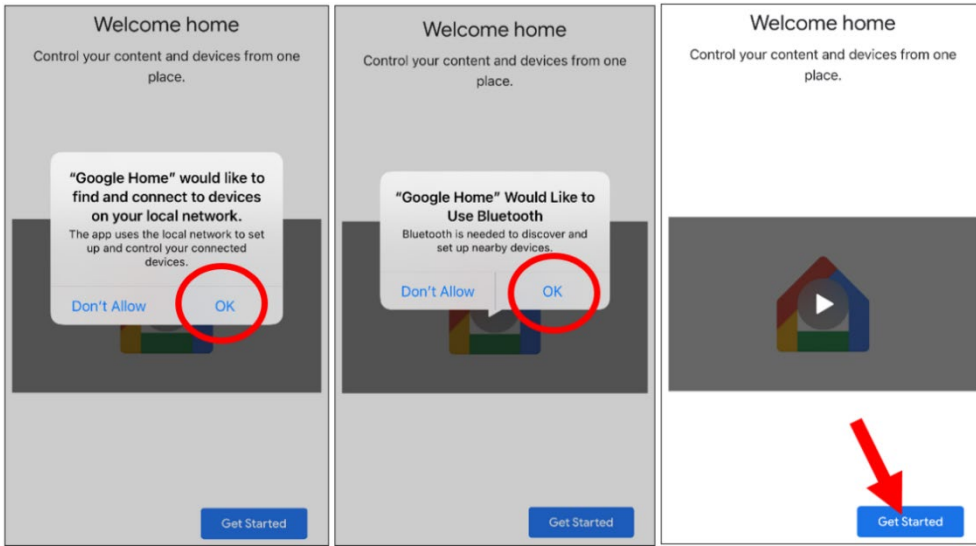

- To login with the same Google account you linked to the NVR.
- Tap "Get Started" to create a home, then tap "New devices."

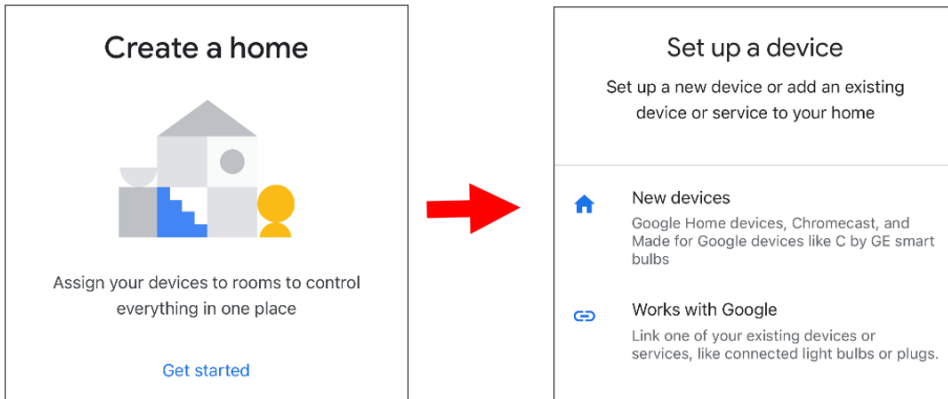

- Input the Home nickname and address, then tap "Next."

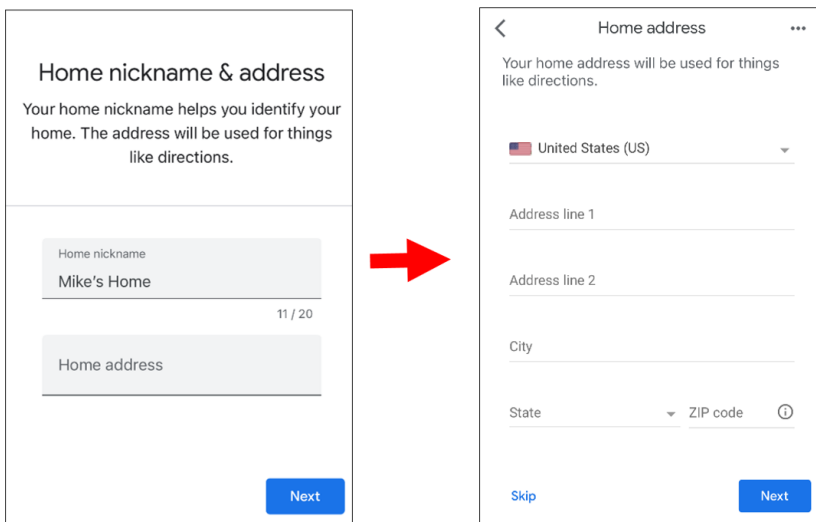

8. Allow location access for the app

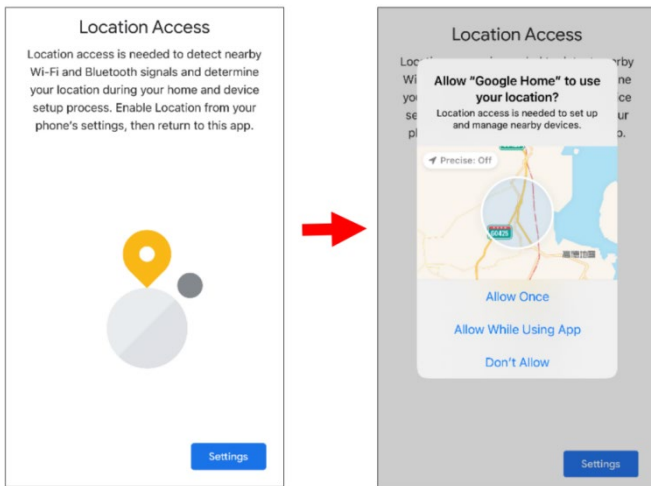

9. The app will automatically try to search for devices on your local network. Choose Chromecast / Google TV. Ensure your Chromecast is turned on, then tap "Next."

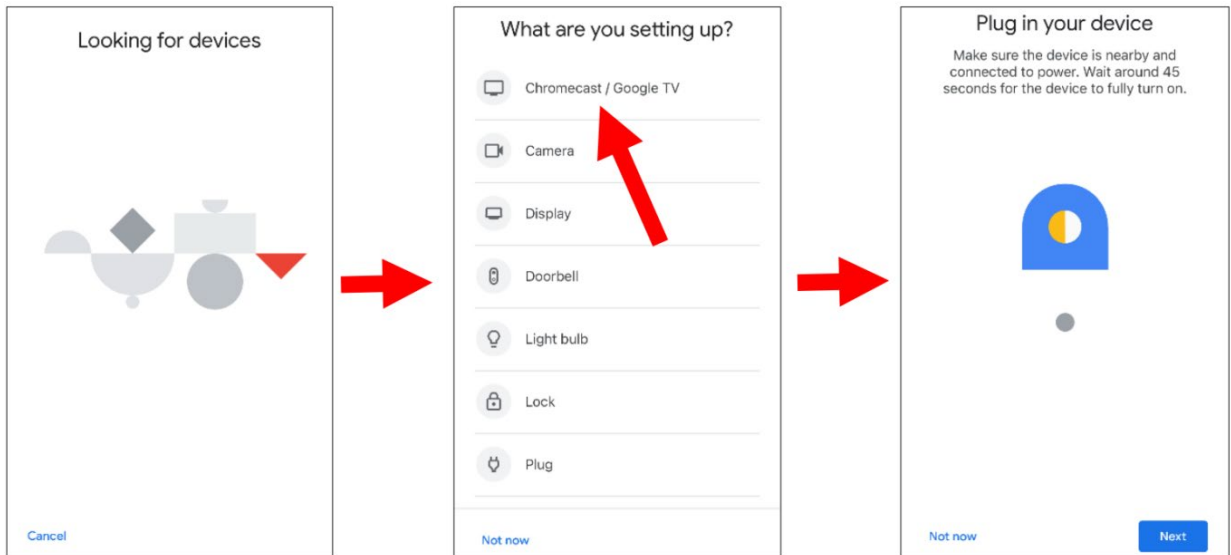

10. Your Chromecast will be found. Tap "Next" to connect. Confirm the code by tapping "Yes."

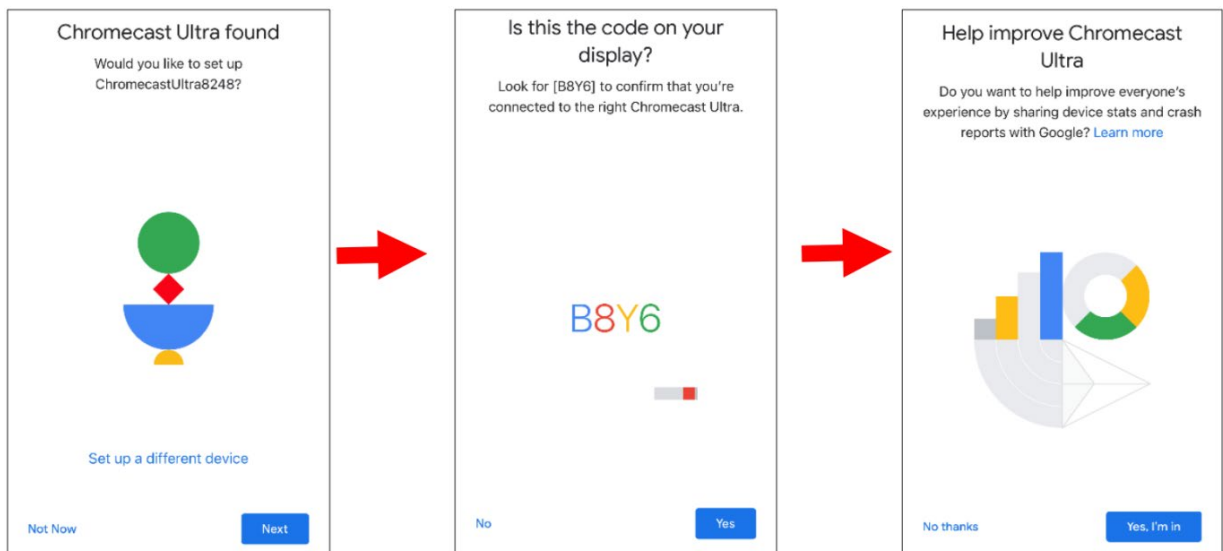

11. Choose a location for your Chromecast, then tap "Next".

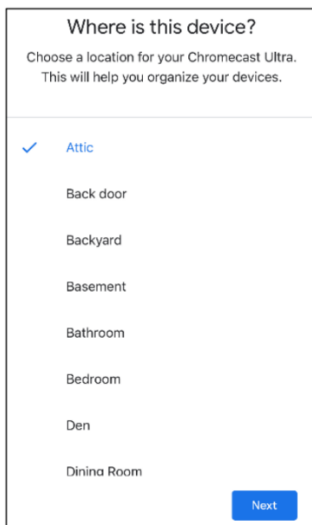

12. Choose the Wi-Fi network for your Chromecast and input the Wi-Fi password to connect. Ensure the Wi-Fi you choose is the same one your mobile phone is connected to and is on the same local network as your NVR. Tap "Continue" to proceed to the next step.

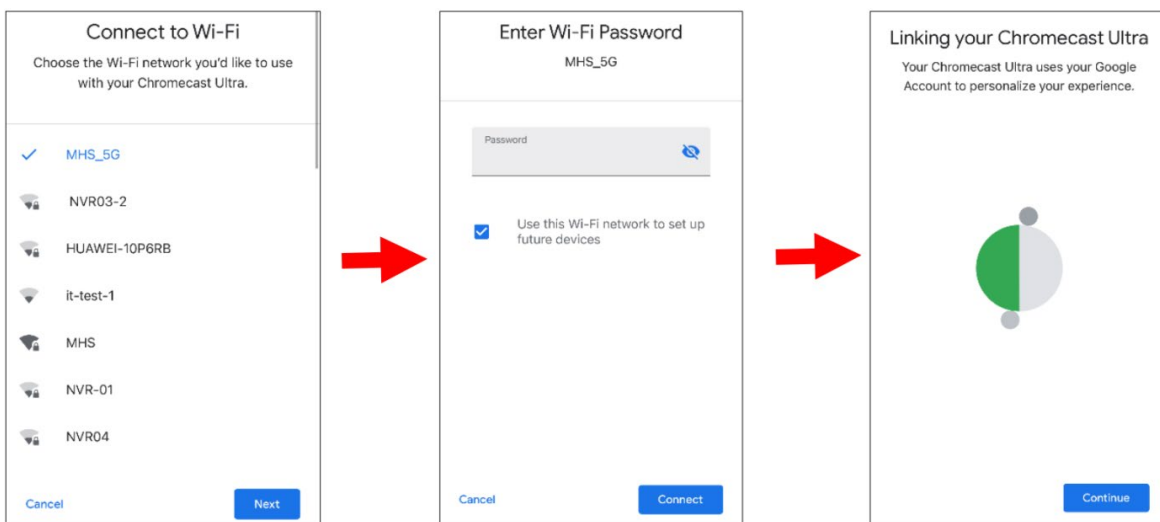

13. Tap "No Thanks" or "Sign Up" to log in to your Google account.

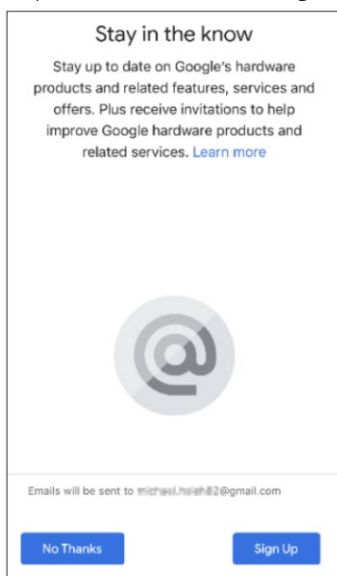

14. Tap "Next," "Skip Tutorial," and then "Finish Tutorial."

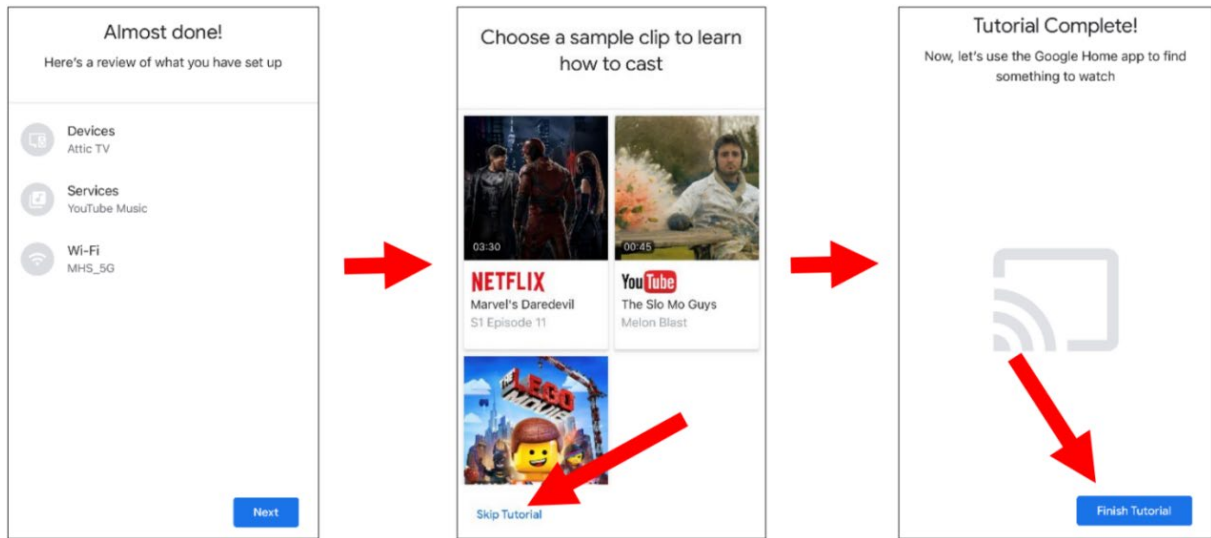

15. Now the Chromecast has been added to your Google Home. Tap the + icon in the top left corner, and then select "Set up device".

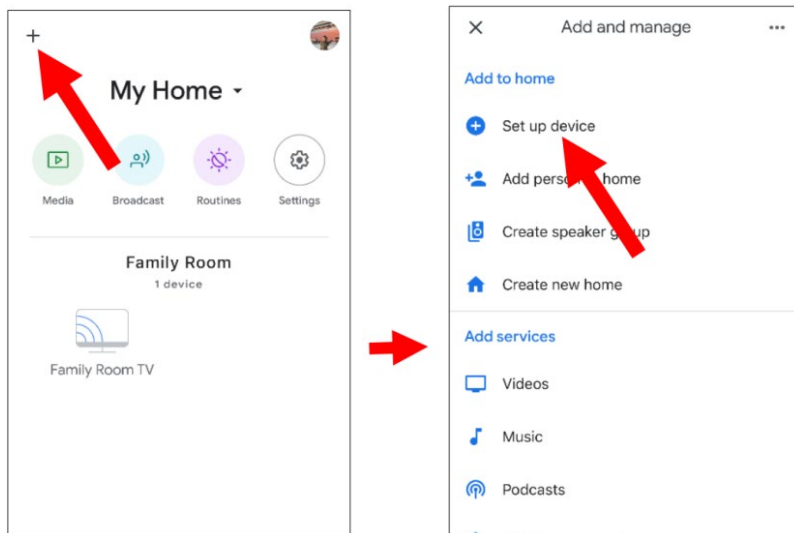

16. Choose "Works with Google." Tap the search icon in the top right corner and input "Smart Camera View".

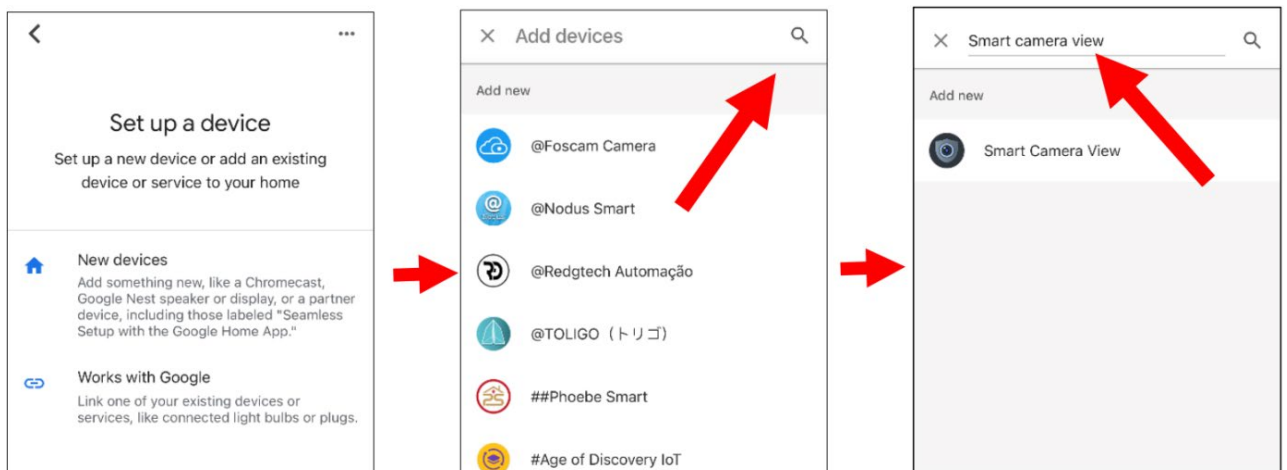

- Tap on "Smart Camera View" in the search results. You will need to sign in to your Google account and allow Google to access your device.

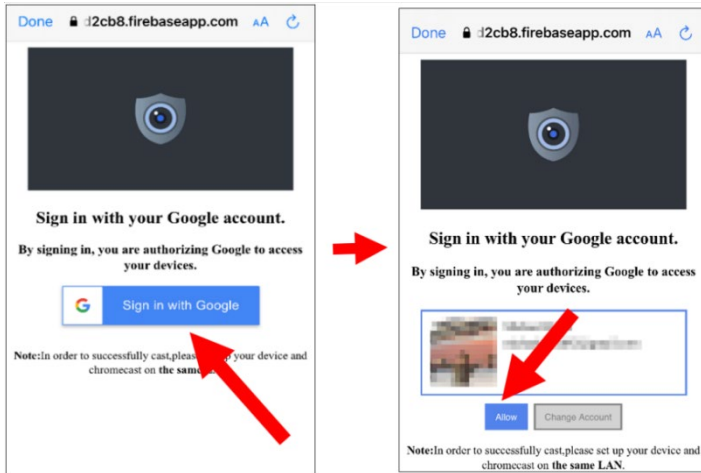

- Wait for a moment, and the Smart Camera View application will be linked to Google Home..



- Now the available cameras in your NVR will be displayed. Choose one of the cameras and tap the "Next" button. Choose a home and location for the cameras step by step. Repeat this step to add all cameras.

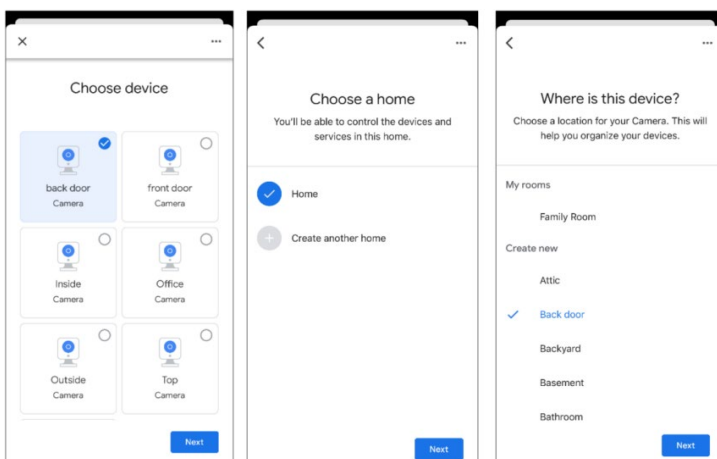

20. Search for and install the Google Assistant app on your mobile phone from the app store.

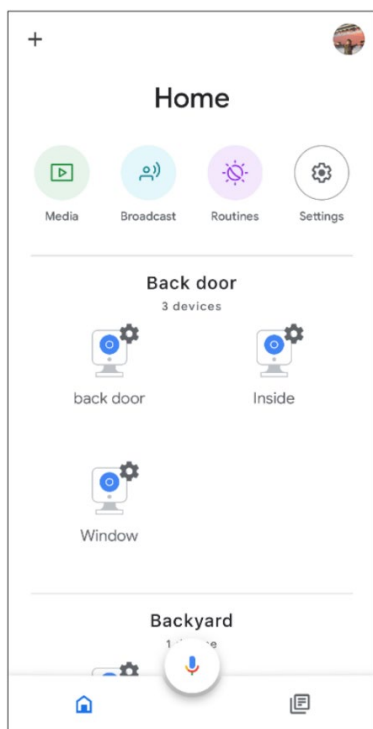

21. Run the Google Assistant, and log in to your Google account, ensuring it is the same one you linked to the NVR.
22. Now, you're able to stream your camera to your TV monitor by using text or voice command, like "Show/play [camera name] Camera on [TV name] TV", if your camera is named "Office", you could say "Play office camera on Mike TV".

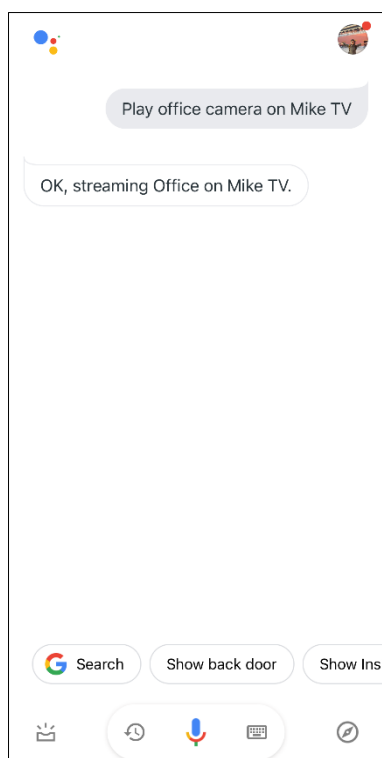

5.5.6 Platform Access

This section is primarily used to configure protocols for connecting to third-party platforms. Through these protocols, you can integrate the NVR with third-party platforms to stream video or push event information.

5.5.6.1 Onvif

This function is primarily used to connect the NVR to third-party platforms.

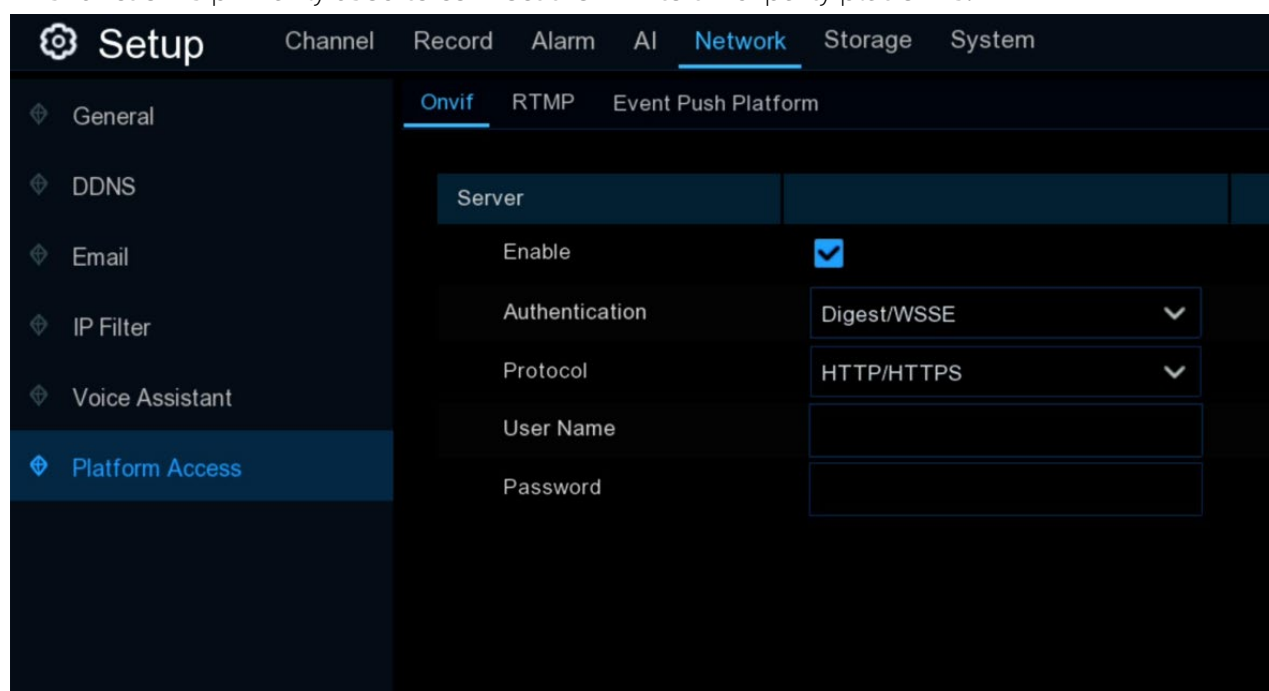

Enable: Enable switch.

Authentication: Choose one of four login authentication methods: Digest_sha256, Digest, Digest/WSSE or WSSE.

Protocol: Select from the supported connection protocols: HTTP/HTTPS, HTTPS, and HTTP.

User Name: Set a username for platform connection.

Password: Set a password for platform connection.

Note: The image displayed when connected via the Onvif protocol is always from the first channel

5.5.6.2 RTMP

Through the RTMP protocol, you can push the NVR's audio and video streams to video sharing websites for live broadcasting, such as YouTube.

Using YouTube as an example, to use this function, you need to:

- Register a YouTube account and create a live streaming studio.
- Set the URL and live code of the live streaming studio.
- Set the live server address on the NVR.
- Enable and configure the code stream type and live broadcasting channels.
- Save the configuration and refresh the YouTube live room page to start watching the live broadcast

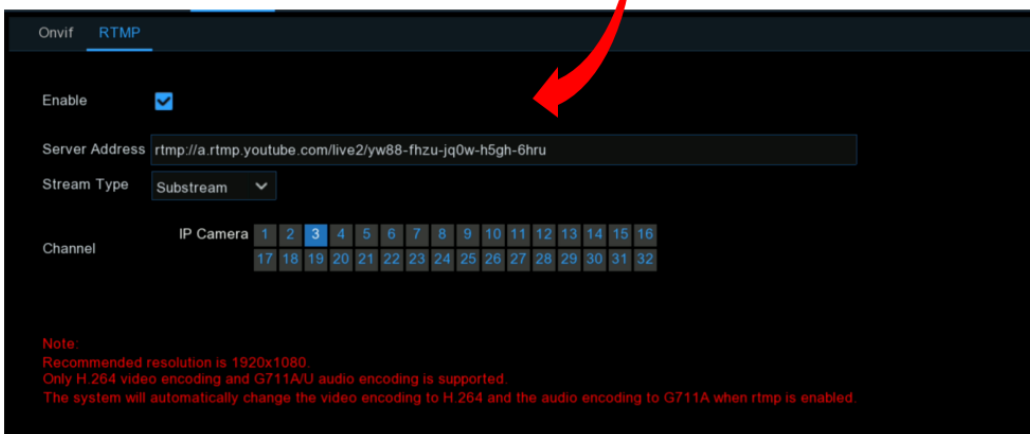
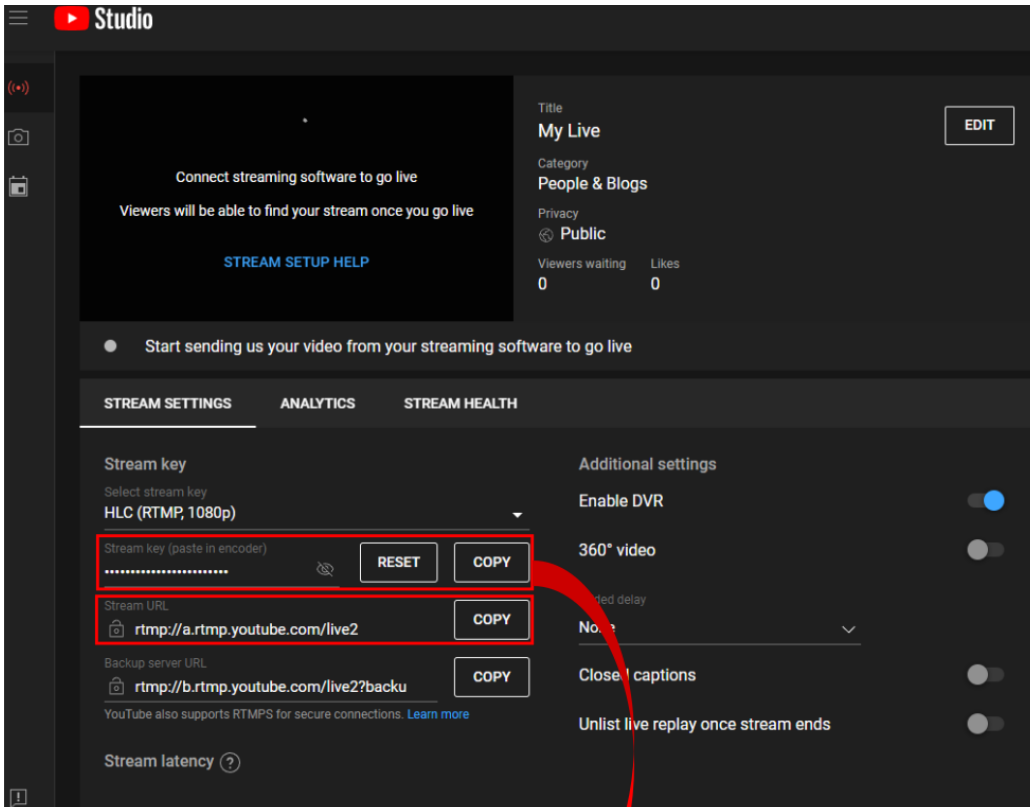

Enable: Enable or disable the RTMP live broadcasting function.

Server Address: Enter the live broadcasting address and live code of the YouTube server. (Note: Use a "/" between the live broadcasting address and the live code.)

Stream Type: Select the stream type for the live broadcasting channel. Both the main stream and substreams are supported.

Channel: Select the channel for live broadcasting. Only one channel can be selected.

Note:

- To ensure optimal live broadcasting quality, it is recommended that the resolution of the stream does not exceed 1920 × 1080.
- Live broadcasting is supported only for data streams using the H.264 video encoding format and G711A/U audio encoding format
- YouTube live code can be assigned to only one device and cannot be reused.

5.5.6.3 Event Push Platform

This function is used to push alarm information from the device to a specified third-party platform. Ensure that the third-party platform has completed the necessary integration and testing with the device. Event push can be done via HTTP or UDP methods.

Event push is divided into HTTP push and UDP push: HTTP has POST and GET methods, UDP has unicast, multicast and broadcast methods.

- HTTP Push

Enable: Enable or disable the event push function.

Name: Set the device name for sending alarm information to the third-party platform.

Push Method: Check HTTP for HTTP push method.

User Name: User name of the third-party platform

Password: Password of the third-party platform

Server Address: Address of the third-party platform

Port: Port of the third-party platform server (range 1-65535)

URL: API endpoint of the third-party platform server

Method: Type of HTTP push. Supports POST and GET methods. Only HTTP-POST supports image push, while others only send messages without images. The alarm types for image push are consistent with those in the web preview alarm bar.

Interval: Keep-alive interval. The device will send messages to the server at the set interval. UDP does not have a keep-alive mechanism.

- UDP Push

The screenshot shows the 'Event Push Platform' configuration page. At the top, there are tabs for 'Onvif', 'RTMP', and 'Event Push Platform'. The 'Event Push Platform' tab is active. Below the tabs, there are several configuration options:

- Enable:** A checkbox that is checked.
- Name:** An empty text input field.
- Push Method:** Two radio buttons: 'HTTP' (unselected) and 'UDP' (selected).
- UDP Method:** A dropdown menu with 'Broadcast' selected.
- UDP Address:** A text input field containing '255.255.255.255'.
- UDP Port:** A text input field containing '5000'.

Enable: Enable or disable the event push function.

Name: Set the device name for sending alarm information to the third-party platform.

Push Method: Check UDP for UDP push method.

UDP Method: Supports three methods: Unicast, Multicast, and Broadcast:

- **Unicast:** Enter the client UDP server's IP address and port to receive push messages. Only this address will receive the messages.
- **Multicast:** Multiple client UDP servers on the same subnet using the same UDP address and port can receive the messages. Others outside this UDP address will not.
- **Broadcast:** All UDP servers on the same subnet can receive the messages

UDP Address: Address of the UDP server.

UDP Port: Port of the UDP server (range 1-65535).

5.6 Storage

This section is primarily responsible for managing local and remote storage for the NVR, including hard disk storage management, cloud storage configuration, and settings for FTP remote backup storage. It provides users with multiple storage choices to meet different data storage and backup needs.

5.6.1 HDD

This menu is used to manage and configure internal or external hard disk drives of the NVR, such as formatting disks, setting recording modes, and disk detection.

Note: The models supporting four hard disk bits and above will display the Slot.NO bar, the information corresponding to the hardware SATA slot number.

The screenshot displays the 'Disk' management interface. At the top, there are tabs for 'Disk', 'Disk Group', and 'S.M.A.R.T.'. Below is a table with the following columns: No., Slot No., Serial No., Edit, Model, Firmware, Type, Disk Group, State, Free/Total, and Free/Total. The table contains four rows of disk information:

No.	Slot No.	Serial No.	Edit	Model	Firmware	Type	Disk Group	State	Free/Total	Free/Total
<input type="checkbox"/> 1	HDD1	WD-WCC4M1EYR7ZZ		WDC WD20PURX-64PFUY0	80.00A80	RW	Group1	FULL	0M/1863G	0s/29Ho
<input type="checkbox"/> 2	HDD2	WD-WCC4M1EYR2YF		WDC WD20PURX-64PFUY0	80.00A80	RW	Group1	FULL	0M/1863G	0s/29Ho
<input type="checkbox"/> 3*	HDD4	80OX321AS		TOSHIBA DT01ABA300V	MZ6OABB0	RW	Group2	Normal	293G/2794G	38Hour/363
<input type="checkbox"/> 4E*	ESATA	WD-WX22D81P803V		WDC WD22EJRX-89BEMY0	80.00A80	RW	Group1	Normal	1010G/1863G	16Hour/29I

Below the table, there are configuration options: 'Overwrite' set to 'Auto', 'Record On ESATA' set to 'Enable', and buttons for 'Format HDD' and 'Add NetHDD'. At the bottom, there is a warning message: 'It is strongly recommended NOT to record more than 32 channels' video into a single HDD group.' and buttons for 'Default' and 'Apply'.

Format HDD: Click the checkbox to select the hard drive then click this button to format. You have three options to select from:

- Format the entire hard disk. All data will be erased: As stated, all data including events, log files and analytic information will be erased.
- Only format the record partition. All record data will be erased: Only data such as videos, snapshots and log files will be erased. All analytic information will be kept.
- Only format the general partition. All AI-related data may be erased: Only analytic information will be erased. Videos, snapshots and log files will be kept on the hard drive.

Select the relevant option, then click "OK". Input your password, then click "Authenticate". A message will appear noting the data that will be erased. Click "OK" to continue.

Overwrite: This instructs your NVR to overwrite the oldest video files as the hard drive becomes full. You also have the option of selecting the amount of days for recordings to be kept before they are overwritten. For example, if you choose the option 7 days then only the last 7 days' recordings are kept on the HDD.

To prevent overwriting any old recordings, select **OFF**. If you have set Off on this feature, please check the HDD status regularly to make sure the HDD is not full. Recording will be stopped if HDD is full. We recommended leaving the **Auto** selection as this prevents your NVR from running out of storage space.

Record on ESATA: This menu only displayed when your NVR is coming with an E-SATA port on the rear panel and your E-SATA HDD has been connected to the NVR already. It will allow to record the video to external E-SATA HDD to enhance your HDD capacity. If the E-SATA recording function is enabled, E-SATA backup function will be disabled.

Add NAS HDD: To add your NAS disk. NAS is only used for extending video and image storage. The AI face database, license plate database, and voice prompt files can only be saved on the local hard disk. (**Note:** AI database, license plate database and video prompts file only is stored in local HDD drive.)

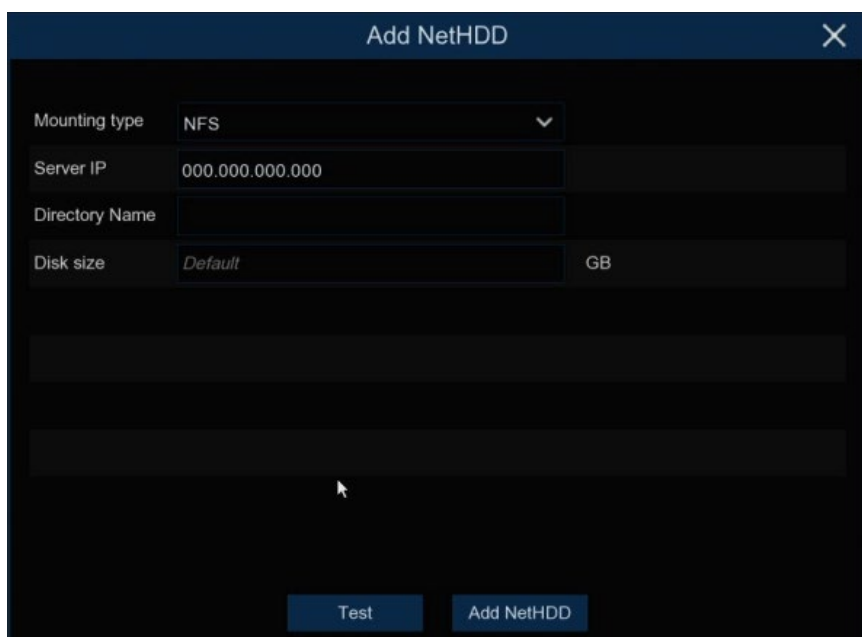

1. **Mounting Type:** Choose the mounting type from NFS and SMB/CIFS. You would need to input the account name and password of NAS if you choose SMB/CIFS.

2. **User Name:** Enter the NAS account name (In NFS mode, it is in an unselectable state)
3. **Server IP:** Enter the IP address of NAS storage.
4. **Password:** Enter the NAS password (In NFS mode, it is in an unselectable state)
5. **Directory Name:** Input the directory name on which you want to save your recording data.
6. **Disk Size:** Set the capacity size of the NAS storage.
7. **Test:** Click to test the connection to the NAS storage.
8. **Add NAS HDD:** Click to add NAS storage.

If your NVR supports to install multiple hard disks and more than 1 hard disk is installed in your NVR, the edit button  will be appear in your system, you can click it to edit the HDD as below:

HDD ID:	Disk 1
Disk Type	Read Write Disk
Disk Group	Record Disk Group 1

Disk Type: You can set the hard disk to be Read Write, Read Only, or Redundant.

- **Read Write** type is the normal status for an HDD to save recordings or search recordings to play. If all the installed hard disks are set to Read Write mode, the NVR will save recordings to the hard disks sequentially.
- To prevent important video data from being overwritten during cyclic recording, the hard drive disk can be set as **Read Only** type. New recordings will not be able to be saved to this read-only disk. You can still search and play recordings from this read-only disk.
- A **Redundant** hard disk can be used to save the same recordings as what is saved to the Read Write hard disk(s). When a redundant disk is set, the system can save recordings in parallel to both the Read Write hard disk and the redundant hard disk in case of hard disk failure.

Note:

1. Redundant disk supports to save mainstream recording only.
2. If the disk type has been changed, the hard disks might be unmounted and offline. Please wait a while till the hard disks get mounted again.
3. For NVR with more than 32 channels, only Read Write and Read Only types are available

Disk Group: You can set the disks into different disk group for recording. See more on section [5.6.1.1 Disk Group](#).

5.6.1.1 Disk Group

If your NVR supports installing multiple hard disks, and more than one hard disk is already installed in your NVR, you will see this menu. With the Disk Group function, you can assign different cameras to different hard disks for recording, in order to reduce the loading on a single hard disk and extend the life of the hard disk. For example, record channels 1-16 to one disk group, and record channels 17-32 to another disk group.

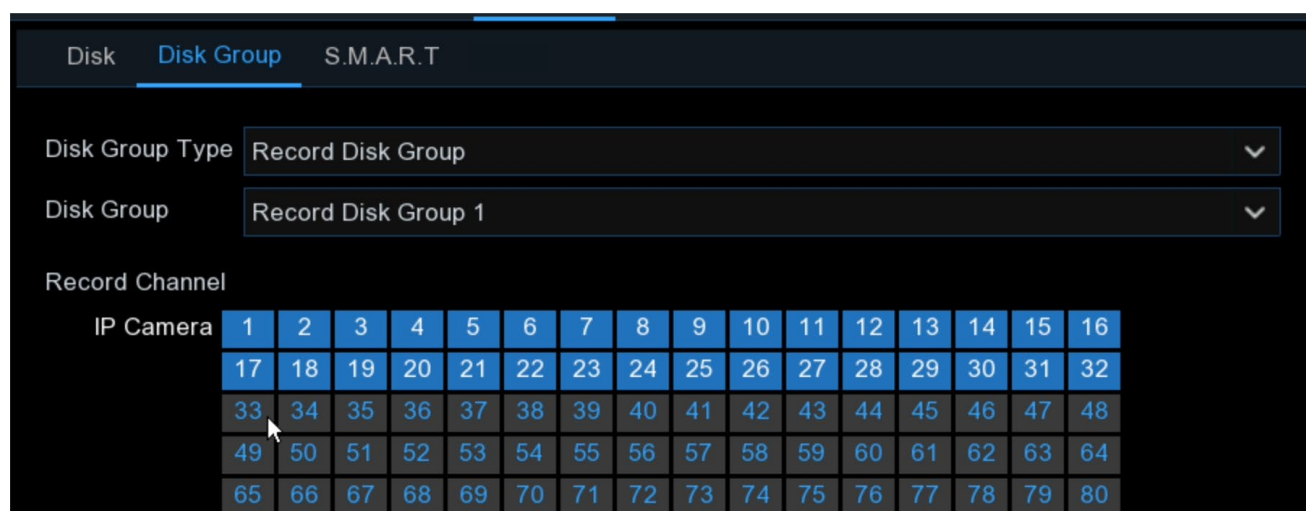

1. On the disk list page, click on the edit button  of the hard disk you want to configure, and then select its "Disk Type" and "Disk Group".
2. Go back to the "Disk Group" page, choose a Disk Group Type. If all the hard disks are set as Read Write mode, only Record Disk Group is available to choose here. If one or more hard disks are set as Redundant mode, Redundant Disk Group will be available to choose here.
3. Choose the "Disk Group".
4. Select the Record Channel. It indicates which camera(s) will be recorded and saved into the hard disk(s) in the selected group. It is recommended that the number of video channels configured in a single disk group should not exceed 32.
5. Click "Apply" to save your settings.

5.6.1.2 S.M.A.R.T

The S.M.A.R.T feature is used to display technical information on the hard drive installed inside your NVR. You can also perform a test to evaluate and detect potential drive errors.

Disk Disk Group **S.M.A.R.T**

HDD ID: Self-check Type:

Self-check State: Not detected Utility Time(d): 280

TEMP(°C): 37 Whole Evaluation: PASSED

S.M.A.R.T. Info:

ID	Attribute Name	Status	Flags	Value	Worst	Threshold	Raw Value
0x1	Raw Read Error Rate	OK	b	100	100	16	0
0x2	Throughput Performance	OK	5	100	100	54	0
0x3	Spin Up Time	OK	7	135	135	24	405 (Average 407)
0x4	Start/Stop Count	OK	12	100	100	0	1686
0x5	Reallocated Sector Count	OK	33	100	100	5	0
0x7	Seek Error Rate	OK	b	100	100	67	0

Self-check Type: There are three types available:

- **Short:** This test verifies major components of the hard drive such as read/ write heads, electronics and internal memory.
- **Long:** This is a longer test that verifies the above as well as performing a surface scan to reveal problematic areas (if any) and forces bad sector relocation.
- **Conveyance:** This is a very quick test that verifies the mechanical parts of the hard drive are working.

Note:

1. When performing a test, your NVR will continue to work as normal.
2. If an HDD S.M.A.R.T error is found, the HDD can still be used, but there will be a risk of losing recording data. It is recommended to replace with a new HDD.

5.6.2 Cloud Storage

Your NVR can upload snapshots and video recordings to cloud storage via Dropbox™ or Google Drive™, allowing you to store and access these files remotely whenever needed.

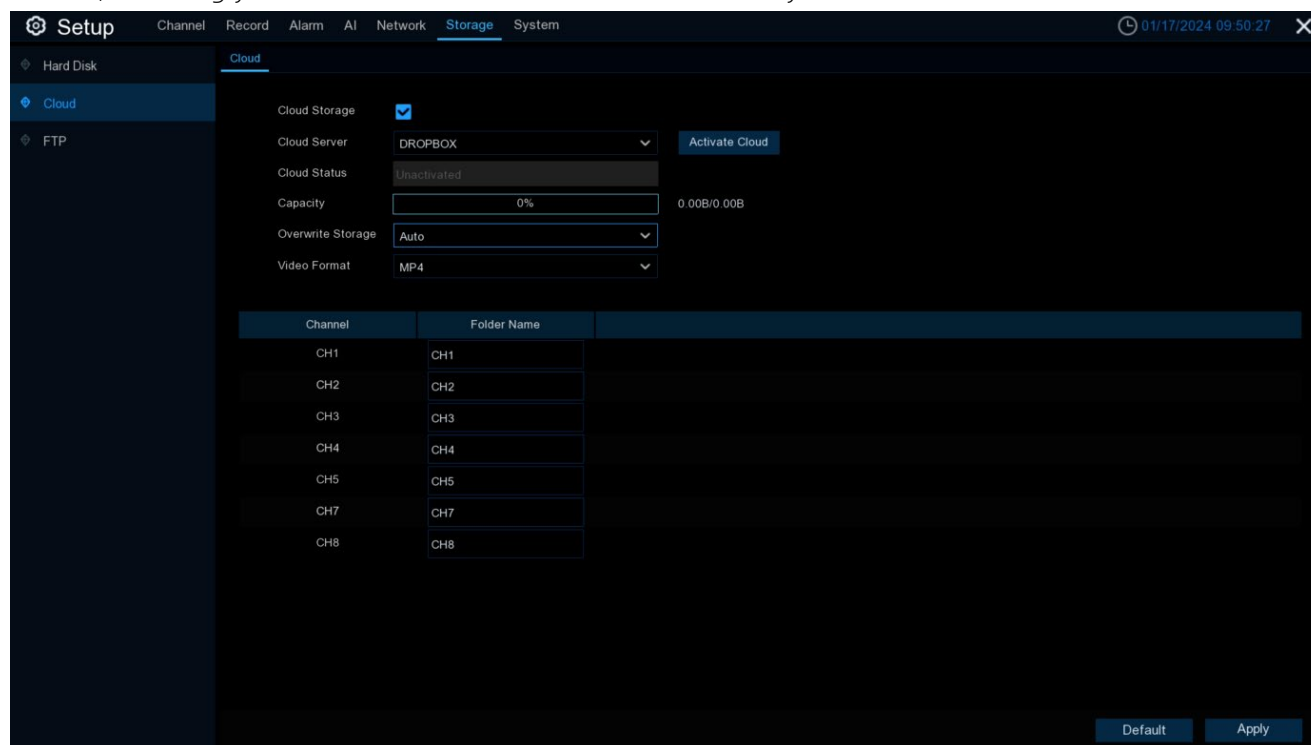

Cloud Type: Select whether to use Dropbox or Google Drive.

Cloud Status: This will indicate "Activated" when cloud storage is active.

Capacity: When activated, this will show how much free space remains in your cloud storage.

Cloud Overwrite: This instructs your NVR to overwrite the oldest video files when cloud storage becomes full. You can also specify the number of days for recordings to be retained before being overwritten. For example, if you choose 7 days, only the last 7 days of recordings are kept in cloud storage.

To prevent any old recordings from being overwritten, select OFF. If you disable overwriting, please check the storage status regularly to ensure space does not become full, as uploads will stop when storage is full. We recommend leaving Auto selected to prevent running out of cloud storage space.

Video Type: Choose the video format you want to upload.

Folder Name: Create a separate folder for each camera to store its uploaded files.

5.6.2.1 Dropbox Settings

1. Before activation, we recommend creating a Dropbox account first at www.dropbox.com if you don't have one already.
2. Choose "**DROPBOX**" from the "**Cloud Server**" dropdown menu. Click "**Activate Cloud**", and the system will send an activation email to the address configured in Email Setup.

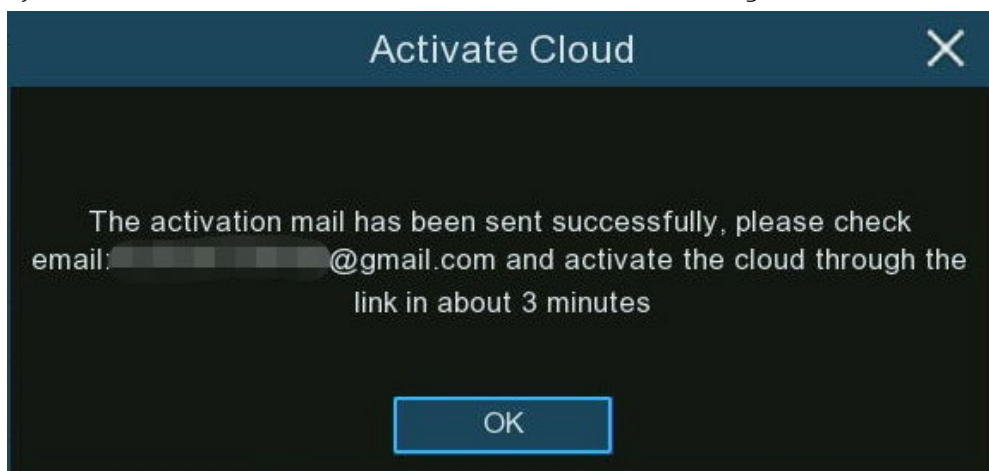

3. Open the email and click the link to go to the cloud server authorization login page. Enter your Dropbox username and password.

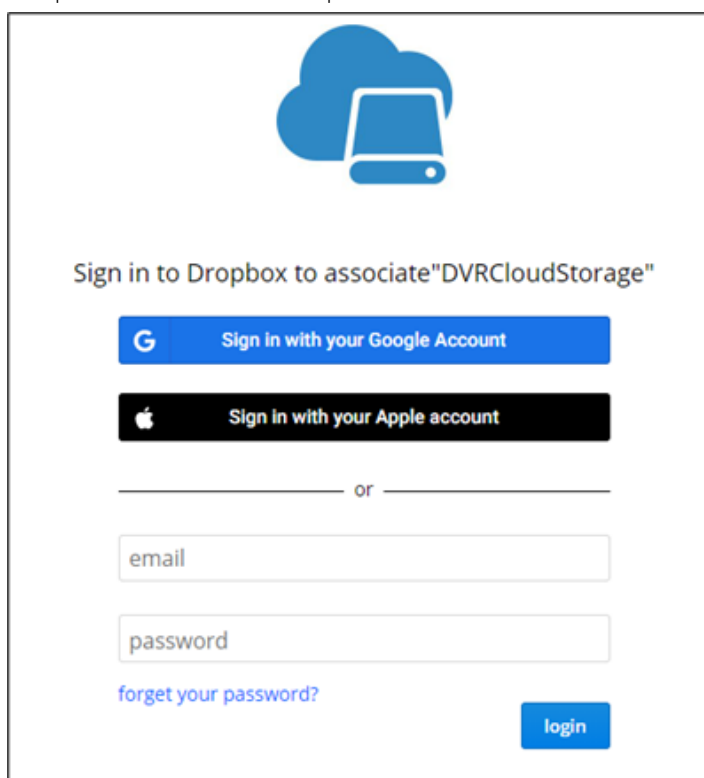

- Enter the DVR's local IP address and web port, then click [Authorize](#).

Dropbox needs to be activated for this device. Please make sure the PC is on the same network as the device and enter the local IP address of the device below. The IP address can be found in the Network section of the device settings.

IP Address	<input type="text" value="172.16.3.90"/>
Port	<input type="text" value="13181"/>

- Enter the DVR's username and password, then click OK.

User Authentication

<input type="text" value="Username"/>
<input type="text" value="Password"/>

- Once authorized, the webpage will open your Dropbox.

Authorization succeeded!Return Dropbox
It will automatically jump in 1 seconds!

- Cloud setup is complete if you find a new folder named with your NVR's device name and MAC address in Dropbox, where alarm pictures and videos will be uploaded.

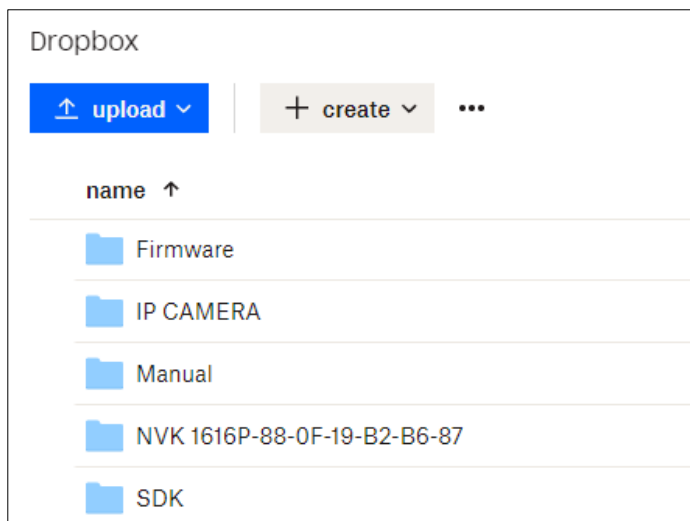

5.6.2.2 Google Drive Settings

1. Before activation, create a Google Drive account at <https://www.google.com/drive/> if you don't have one.
2. Choose "**Google Drive**" from the "**Cloud Server**" dropdown menu. Click **Activate Cloud**, and an activation email with a code will be sent.

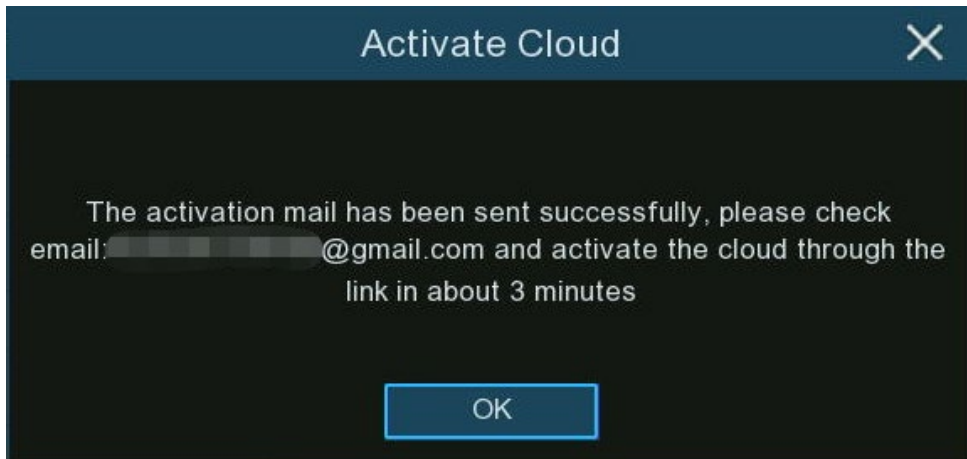

3. Open the email, click the link, enter the activation code, and click **Next**.

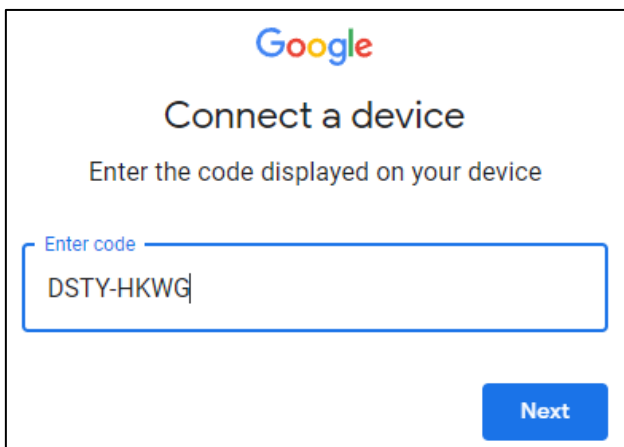

4. Enter your Google account credentials to log into Google Drive.

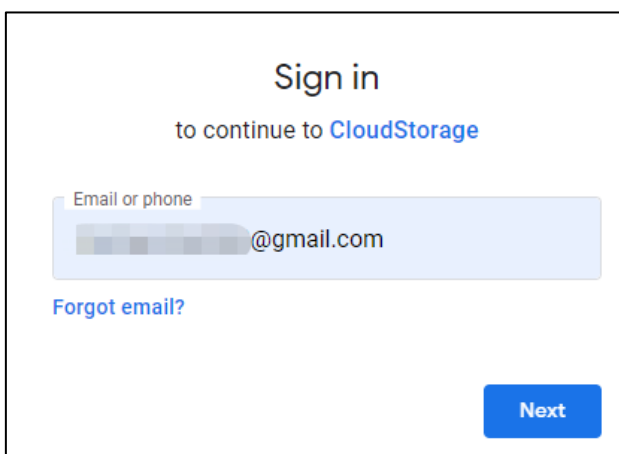

- Click **Allow** to complete setting up your Google Drive cloud storage.

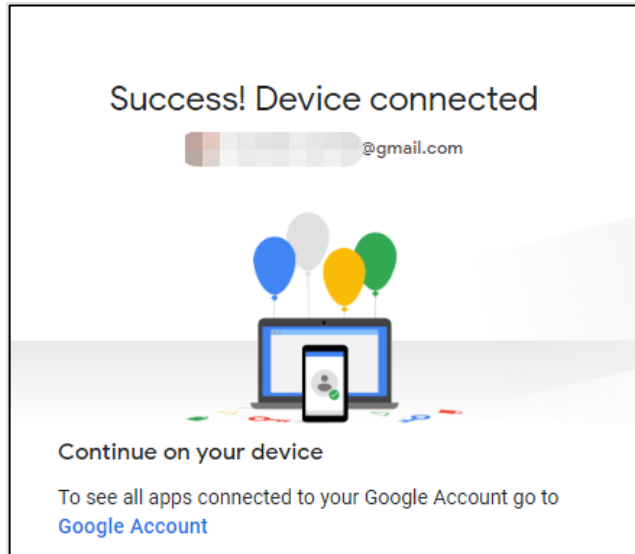
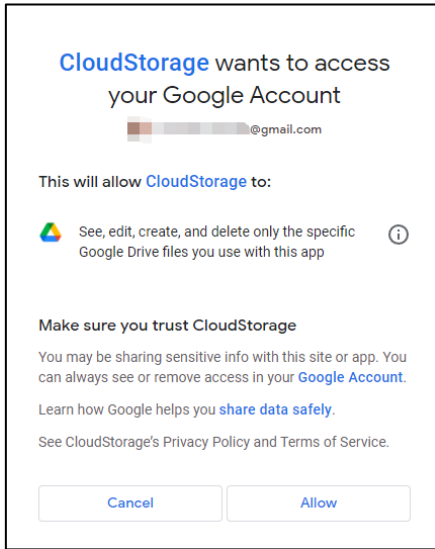

5.6.3 FTP

This menu allows you to configure FTP settings for uploading captured snapshots or videos to your FTP server.

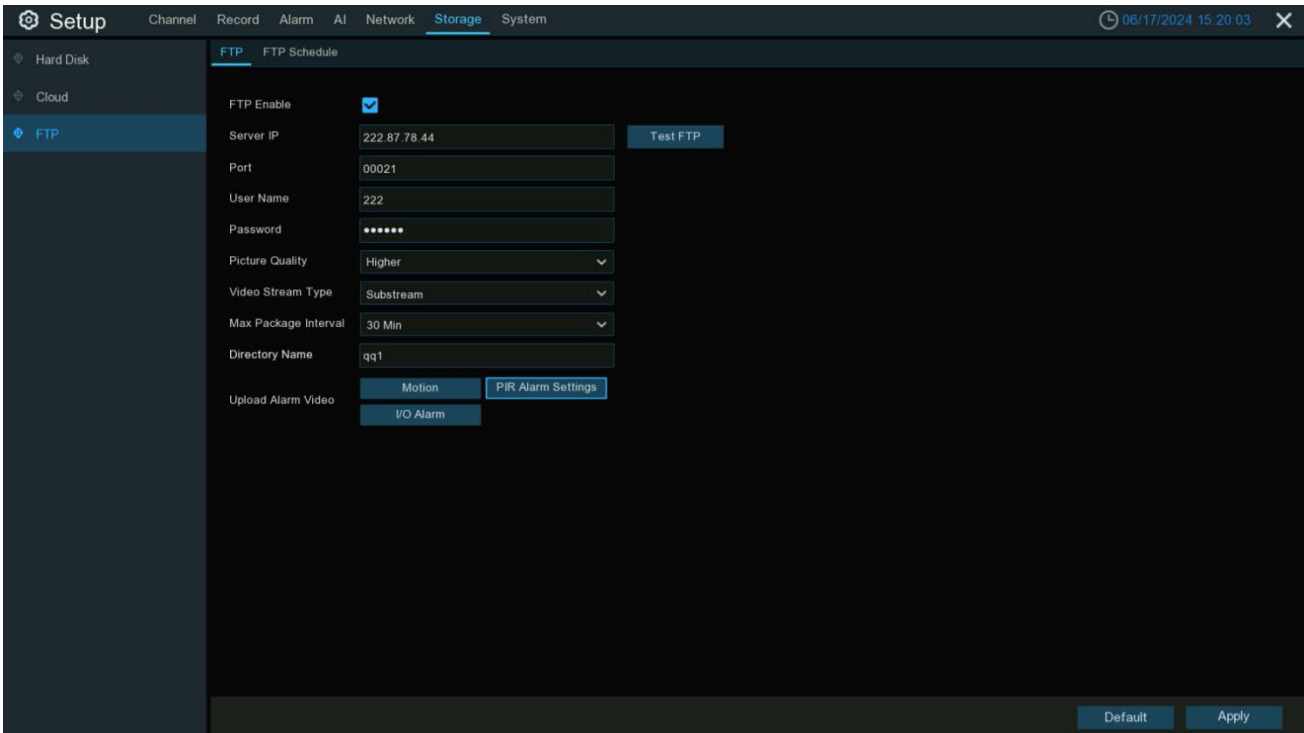

5.6.3.1 FTP Settings

The screenshot shows the 'FTP Settings' configuration interface. It features a dark background with light-colored text and input fields. The 'FTP' tab is active, and the 'FTP Enable' checkbox is checked. The 'Server IP' field contains '222.87.78.44' and has a 'Test FTP' button to its right. Other fields include 'Port' (00021), 'User Name' (222), 'Password' (masked), 'Picture Quality' (Higher), 'Video Stream Type' (Substream), 'Max Package Interval' (30 Min), and 'Directory Name' (qq1). At the bottom, there are buttons for 'Upload Alarm Video' with sub-options: 'Motion', 'PIR Alarm Settings', and 'I/O Alarm'.

FTP Enable: Check this box to enable the FTP function.

Server IP: Enter the IP address or domain name of your FTP server.

Port: Enter the FTP port for file transfers.

User Name/ Password: Enter the username and password for the FTP server.

Picture Quality: Select the desired image quality for snapshots to be uploaded to the FTP server.

Video Stream Type: Choose whether to upload mainstream or substream video.

Max Package Interval: Set the maximum video duration for a single uploaded file. If an event exceeds this duration, a new video file will be created to continue recording.

Directory Name: Enter the directory path on your FTP server to save the uploaded pictures and videos.

Upload Alarm Video: Set the alarm types for which videos should be uploaded to the FTP server. Click the option to access the configuration menu for each corresponding alarm type.

Test FTP: After completing the FTP settings, click this button to verify the configuration. The system will send a test file to your FTP server. If you receive the message "Write to file succeeded!", it means the FTP settings are correct.

5.6.3.2 FTP Schedule

If FTP upload is enabled, alarm images or videos are uploaded 24/7 by default. You can schedule when your NVR uploads alarm images/videos, for example only during daytime hours.

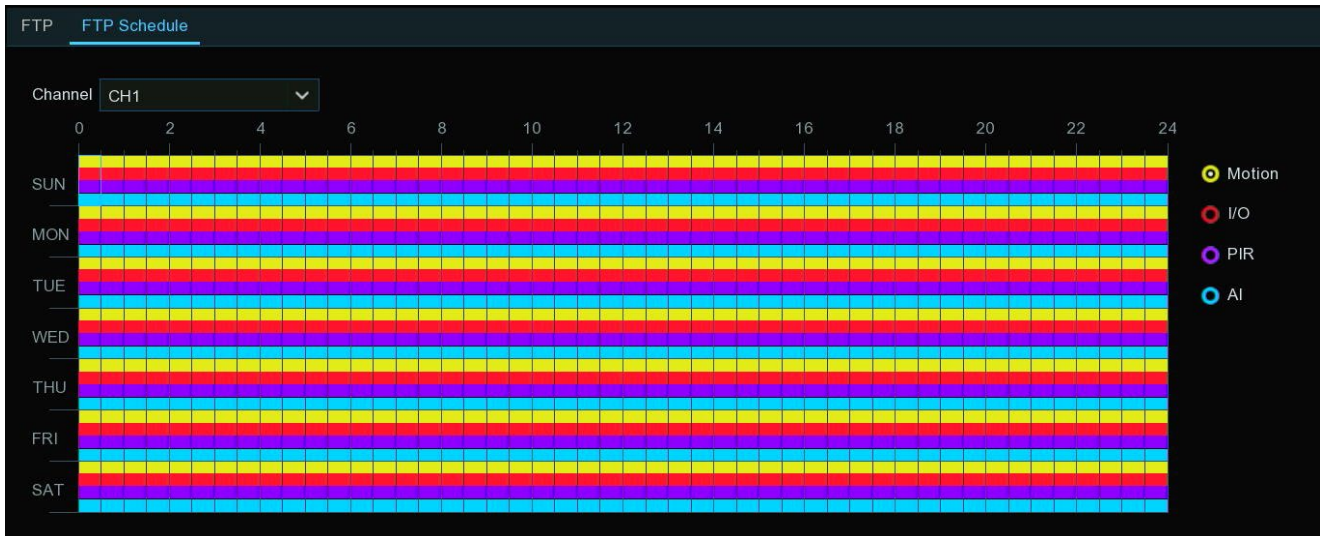

1. Select the camera channel to schedule.
2. Click the checkbox for the alarm type to upload:
 - **Motion:** Upload for motion detection alarms
 - **I/O:** Upload for I/O triggered alarms
 - **PIR:** Upload for PIR detection alarms
 - **AI:** Upload for Intelligent/AI detection alarms
3. Use the mouse to click/drag over time squares to set the desired schedule.
4. Repeat steps 2-3 for other alarm types.
5. The schedule only applies to the selected channel. Use the [Copy](#) function to apply it to other channels.
6. Click [Apply](#) to save settings.

5.7 System Configuration

Change system information such as date, time and region, change passwords and permissions, and more.

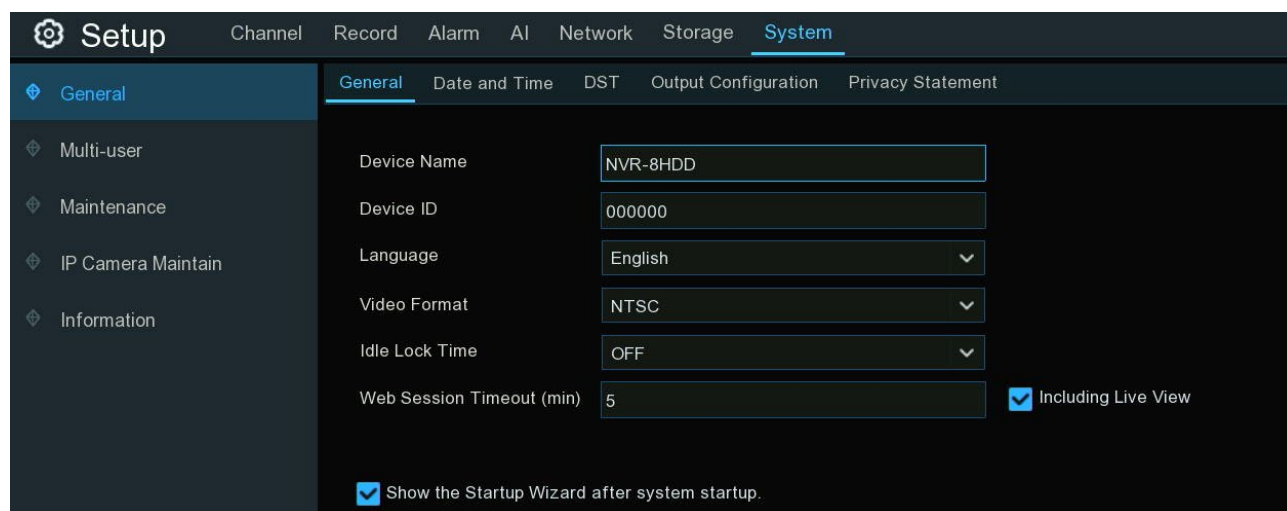

5.7.1 General

Modify general system parameters like language, date & time, display and more.

5.7.1.1 General settings

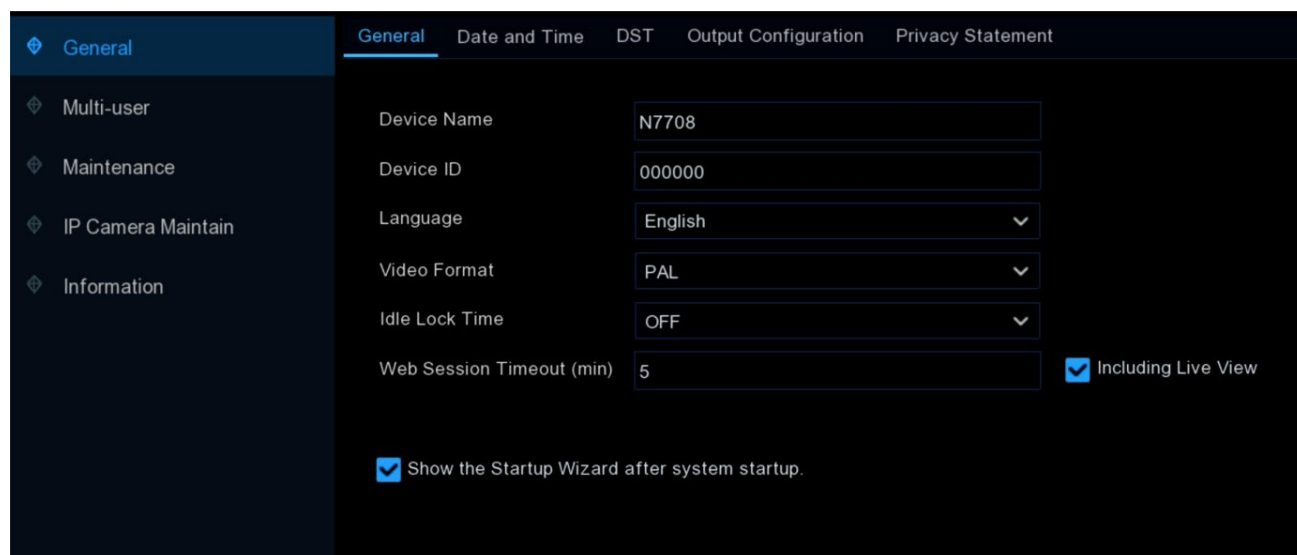

Device Name: Customize the name for your NVR if desired. The name can contain letters and numbers.

Device ID: Enter a numeric ID to identify this NVR. For example, if two NVRs are installed in the same location with IDs 000000 and 111111, using a remote controller without specifying an ID could operate both units. Entering the specific ID 111111 allows controlling only that NVR.

Language: Select the language for the system menus.

Video Format: Select the video standard for your region.

Idle Lock Time: Set the idle timeout period for automatically exiting the main menu and locking the system when there is no operation. Choose a desired timeout duration from the dropdown menu, or select "OFF" to disable auto-exiting/locking when idle (note that this temporarily disables password protection).

Web Session Timeout(min): Enter the idle time in minutes (5-1440 seconds) before terminating the web interface session on device settings pages. Check "Including Live View" to also terminate live view sessions.

Show the Startup Wizard after system startup: Check this box to display the Start-up Wizard each time the NVR boots up.

Enable RAID: Check this box to enable the RAID functionality. After modifying and saving this setting, the system will reboot for the changes to take effect.

5.7.1.2 Date and Time

General	Date and Time	DST	Output Configuration	Privacy Statement
<input checked="" type="radio"/> Static <input type="radio"/> NTP				
Date	06/19/2024			
Time	19:34:51			
Date Format	MM/DD/YYYY			
Time Format	24Hour			
Time Zone	GMT+08:00			

Date: Click the calendar icon to change the date.

Time: Click in the time field to set the time.

Date Format: Choose the preferred date format.

Time Format: Choose 12-hour or 24-hour time format.

Time Zone: Select your local time zone.

NTP Settings

The Network Time Protocol (NTP) automatically syncs your NVR's clock with an internet time server for accurate date/time stamping.

Static
 NTP

Date: 06/17/2024

Time: 15:58:03

Date Format: MM/DD/YYYY

Time Format: 24Hour

Time Zone: GMT+08:00

Server Address: pool.ntp.org

Check "NTP", select a "Server Address", and click "Update Now" to instantly sync. With NTP enabled, the time will auto-update daily at 00:07:50 or on system boot. Click "Apply" to save settings.

5.71.3 DST

The Daylight-Saving Time (DST) function adjusts the clock for DST if applicable in your region.

General Date and Time **DST** Output Configuration Privacy Statement

Enable DST

Time Offset: 1Hour

DST Mode: Week

Start Time: Mar. The 2nd Sun. 02:00:00

End Time: Nov. The 1st Sun. 02:00:00

Enable DST: Check this if your region observes DST.

Time Offset: Select how many hours your local DST deviates from UTC.

DST Mode: Choose whether DST starts/ends on a particular week/day or date:

- **Week:** Select the month, day (e.g. First Sunday), and time for DST start/end.
- **Date:** Select the calendar start/end dates and times for DST.

5.7.1.4 Output Configuration

This menu allows you to configure video output parameters.

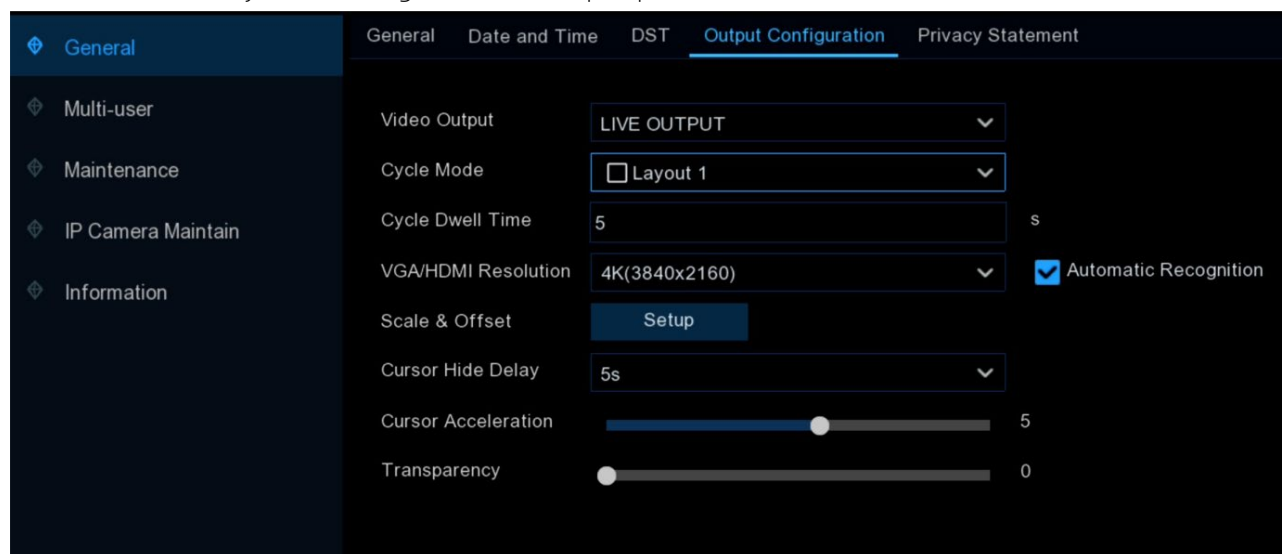

Cycle Mode: Select how many video channels to display simultaneously when your NVR is in cycle mode.

Cycle Dwell Time: Enter the maximum duration in seconds to display each set of video channel(s) in cycle mode before switching to the next set (maximum 300 seconds).

Output Resolution: Set the HDMI/ VGA output resolution. Checking "Automatic Recognition" will automatically set the resolution compatible with your connected monitor when the NVR boots up. The system will prompt you to modify the resolution if a higher one is available on system start.

Scale And Offset: This allows adjusting the size and position of the display window to fit your monitor. Click the "Setup" button to configure scale and offset settings.

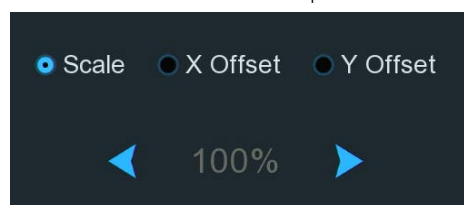

- Scale: Adjust the size of the display window.
- X Offset: Move the display window left or right.
- Y Offset: Move the display window up or down.

Click the relevant checkbox, then use the arrow buttons or mouse scroll wheel to adjust accordingly.

Cursor Hidden Delay: Set the idle time before hiding the mouse cursor. Select "OFF" to disable this.

Cursor Acceleration: Adjust the mouse cursor movement speed.

Transparency: Drag the slider to change the transparency of the menu bar and main menu on-screen.

Note:

1. For NVRs with only a single HDMI and VGA output, these settings apply to that output.

- For NVRs with multiple HDMI outputs, these settings specifically configure the main HDMI1 output.

5.7.1.5 Auxiliary Screen & Decoding

When your NVR is configured with 2 or more HDMI interfaces, you can configure the output parameters individually for the auxiliary HDMI outputs besides the main HDMI1 output in this menu.

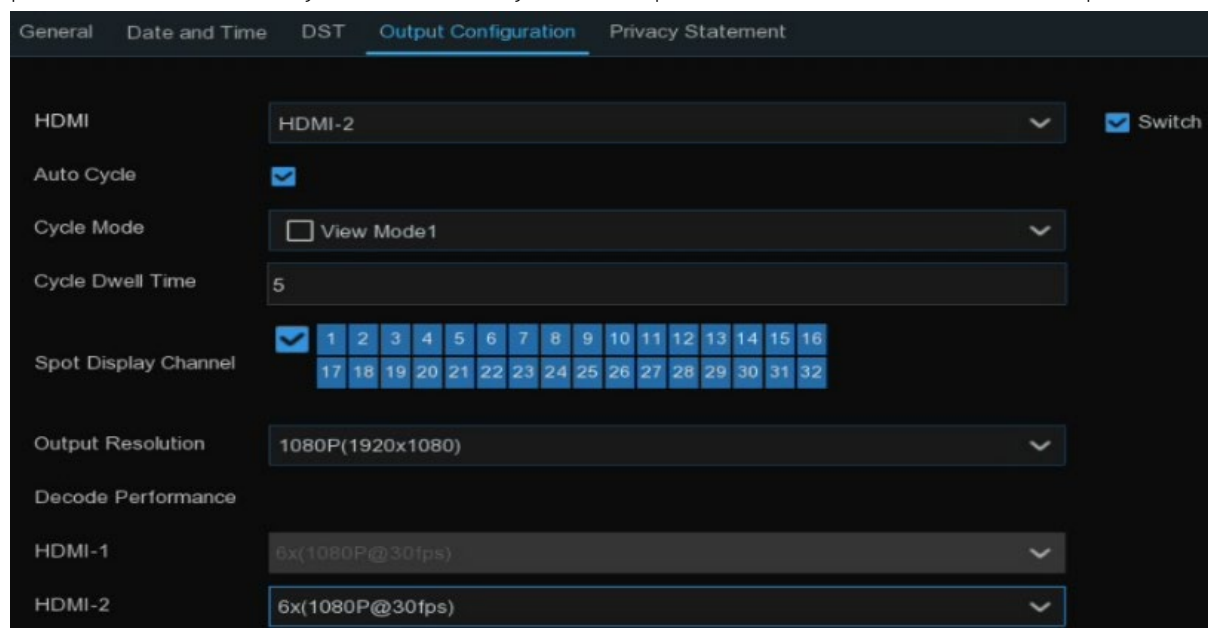

In the **HDMI** menu, select any auxiliary HDMI output other than the main HDMI1 output that you want to configure, then check the "**Switch**" option to enable the display output for the selected auxiliary screen.

Auto Cycle: Enable or disable automatic cycling/sequencing through channels on the auxiliary screen.

- When enabled, the preview display on the selected auxiliary screen will cycle through channels according to the following configured display parameters:

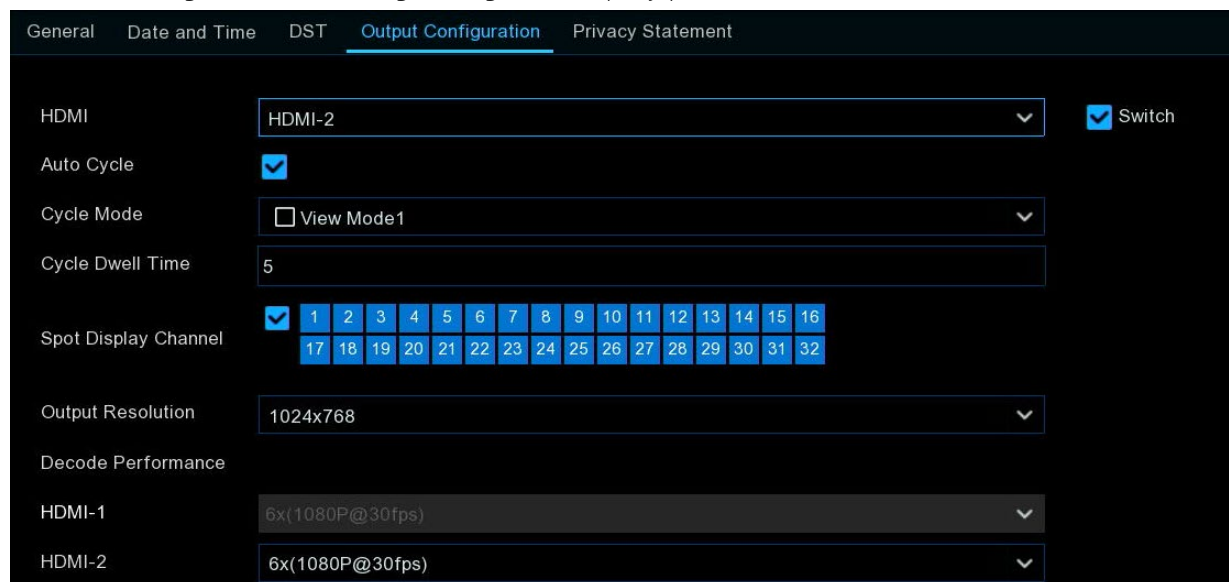

Cycle Mode: Select the number of video channels to display simultaneously during each dwell period of the cycling sequence.

Dwell Time: Set the duration, in seconds, for how long each view will be displayed during the preview cycling on the auxiliary screen.

Auto Cycle Setting: Choose which channels will participate in the automatic cycling display on the auxiliary screen.

- When disabled, the preview display on the selected auxiliary screen will show a fixed view based on the configured display parameters:

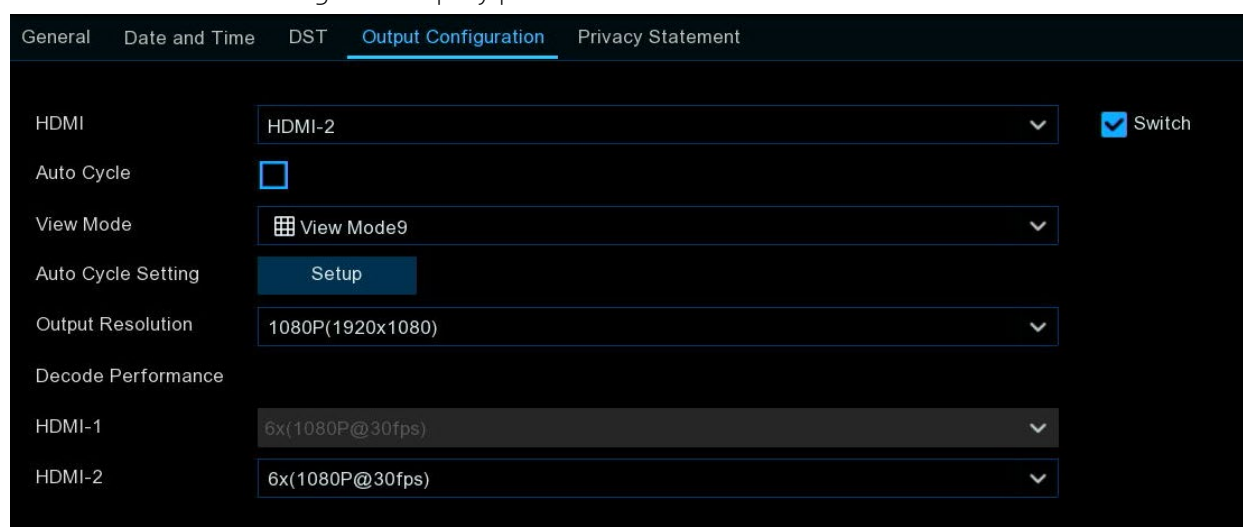

View Mode: Select the number of video channels to be displayed on the auxiliary screen in fixed view mode.

Spot Display Channel: Click the "Setup" button to configure which channels will be displayed on the auxiliary screen in fixed view mode.

Output Resolution: Set the output resolution suitable for the auxiliary screen monitor.

Decode Performance: Set the decoding performance for the selected auxiliary screen. The drop-down menu displays all available decoding performance options for this HDMI auxiliary output under the current configuration. The total decoding performance of the NVR is fixed. When you select a higher decoding performance, the system will automatically reduce the resources allocated to other output port(s). Conversely, if you choose a lower decoding performance, the system will automatically increase the resources allocated to other output port(s).

Audio Output: Enable or disable audio output from the auxiliary screen.

5.7.1.7 Privacy Statement

Click this menu to view the Privacy Statement.

5.7.2 Multi-user

This menu allows you to configure usernames, passwords, and user permissions.

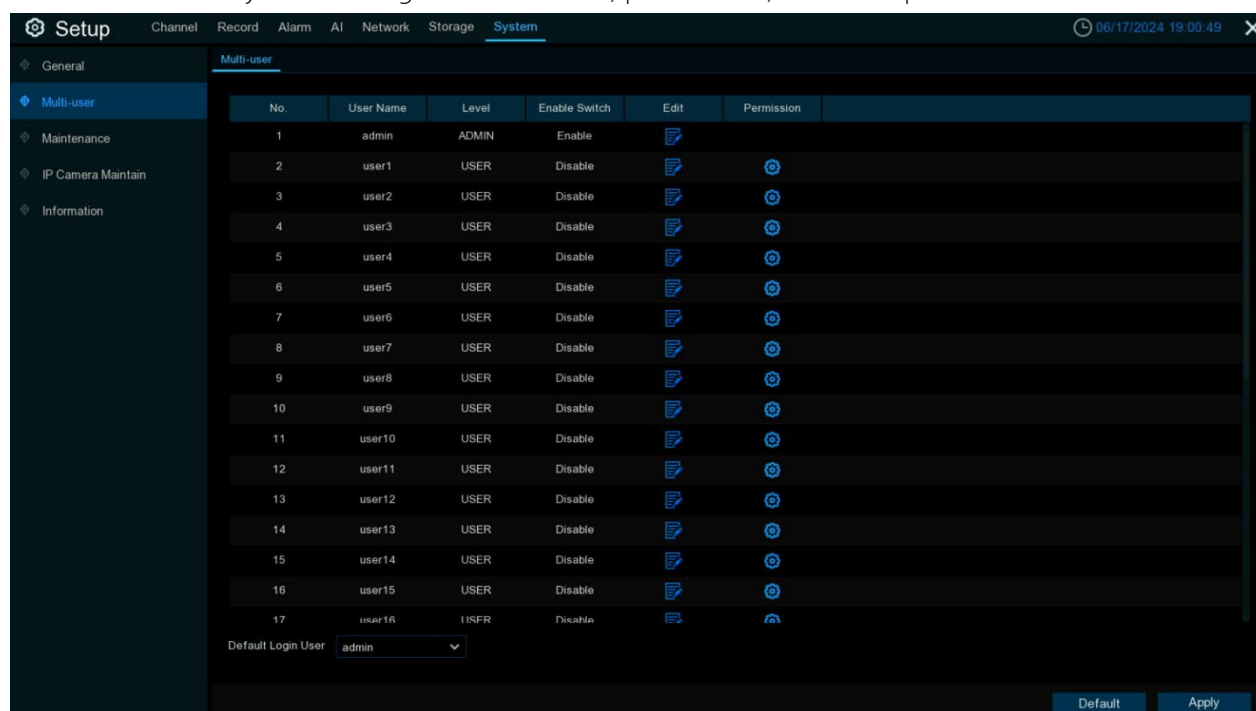

The system supports the following account types:







- **ADMIN** — The system administrator has full control of the system and can change both administrator and user passwords, as well as enable/disable password protection.
- **USER** — Normal users have limited access, which may include live viewing, search, playback, and other functions. You can set up multiple user accounts with varying levels of access to the system.

Default User: Select the user account that will automatically log in when the system starts. The admin is the default user account. If you have created multiple user accounts and wish to disable automatic login, click the drop-down menu and select "None".

5.7.2.1 Edit Users

You can edit a user's password, enable or disable a user, and set permission.

Click the edit button  of the user you want to configure.

No.	User Name	Level	Enable Switch	Edit	Permission
1	admin	ADMIN	Enable		
2	user1	USER	Disable		
3	user2	USER	Disable		
4	user3	USER	Disable		

1) For the Admin account, you can:

Edit
✕

Level: ADMIN

User Name:

Password Strength:

Password:

Use the Admin password as camera activation/connection password

Confirm:

Unlock Pattern:  Draw

Max. Login Number:

Default
Save
Cancel

- Change password: The password must be a combination of 8 to 16 characters, including at least two types of characters from uppercase letters, lowercase letters, digits, and special symbols. Enter your new password twice to confirm, then click Save. You will be required to enter your old password for authentication.

After checking "[Use the Admin password as camera activation/connection password](#)", the Private protocol will use the device administrator password to activate/connect to the connected cameras.

- Enable or disable "**Unlock Pattern**": When enabled, you can draw and save a pattern. You can then use this pattern to unlock the NVR when you log in to the system.

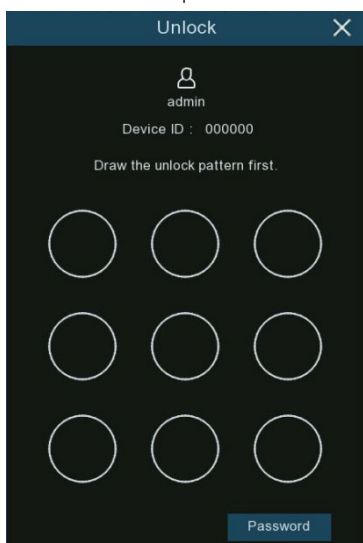

- Set "**Max. Login Number**": This limits the maximum number of simultaneous remote access sessions for this user account. Remote access includes, but is not limited to, web interface, CMS/VMS, mobile apps, and 3rd party platforms.

2) For a sub user account, it's allowed to have below settings.





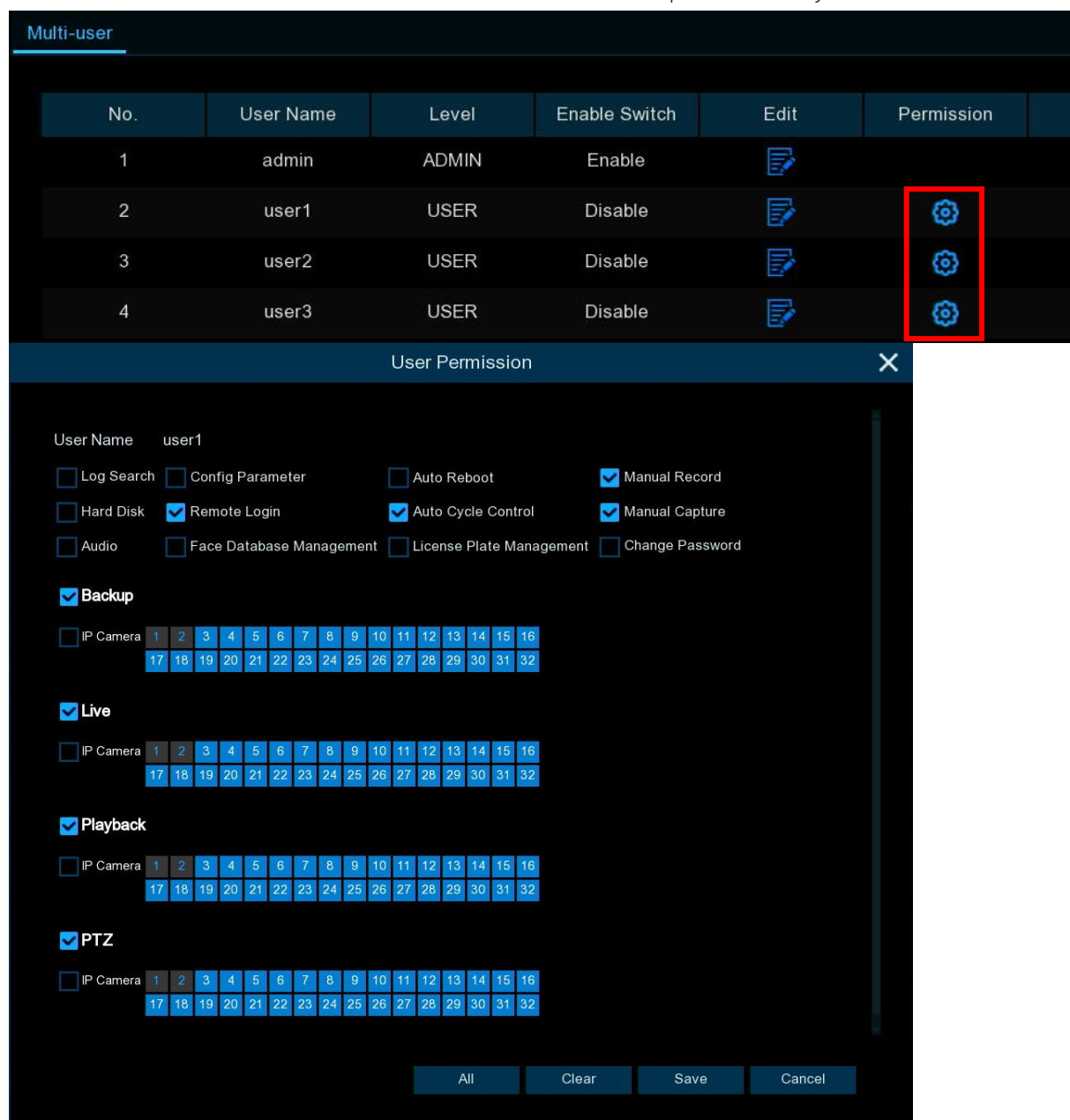

- Enable or disable the user.
- Assign a username and password.
- Set "**Max. Login Number**": This limits the maximum number of simultaneous remote access sessions for this user account. Remote access includes, but is not limited to, web interface, CMS/VMS, mobile apps, and 3rd party platforms.

5.7.2.2 Edit User Permissions

The administrator account is the only account with full control of all system functions. After logging in with the administrator account, you can enable or disable access to specific menus and functions for other user accounts.

Click the "Permission" button  for the account whose permissions you want to edit.



No.	User Name	Level	Enable Switch	Edit	Permission
1	admin	ADMIN	Enable		
2	user1	USER	Disable		
3	user2	USER	Disable		
4	user3	USER	Disable		

User Permission

User Name: user1

Log Search Config Parameter Auto Reboot Manual Record
 Hard Disk Remote Login Auto Cycle Control Manual Capture
 Audio Face Database Management License Plate Management Change Password

Backup

IP Camera 1 2 3 4 5 6 7 8 9 10 11 12 13 14 15 16
 17 18 19 20 21 22 23 24 25 26 27 28 29 30 31 32

Live

IP Camera 1 2 3 4 5 6 7 8 9 10 11 12 13 14 15 16
 17 18 19 20 21 22 23 24 25 26 27 28 29 30 31 32

Playback

IP Camera 1 2 3 4 5 6 7 8 9 10 11 12 13 14 15 16
 17 18 19 20 21 22 23 24 25 26 27 28 29 30 31 32

PTZ

IP Camera 1 2 3 4 5 6 7 8 9 10 11 12 13 14 15 16
 17 18 19 20 21 22 23 24 25 26 27 28 29 30 31 32

All Clear Save Cancel

- Tick the checkboxes of the system menus or capabilities you want the user to access.
- Click **All** to select all permissions.
- Click **Clear** to deselect all permissions.
- Click **Save** to save your changes.

5.7.3 Maintenance

In this section, you can search and view system logs, restore default settings, upgrade the system, export and import system parameters, manage system auto-reboot, and perform other maintenance tasks.

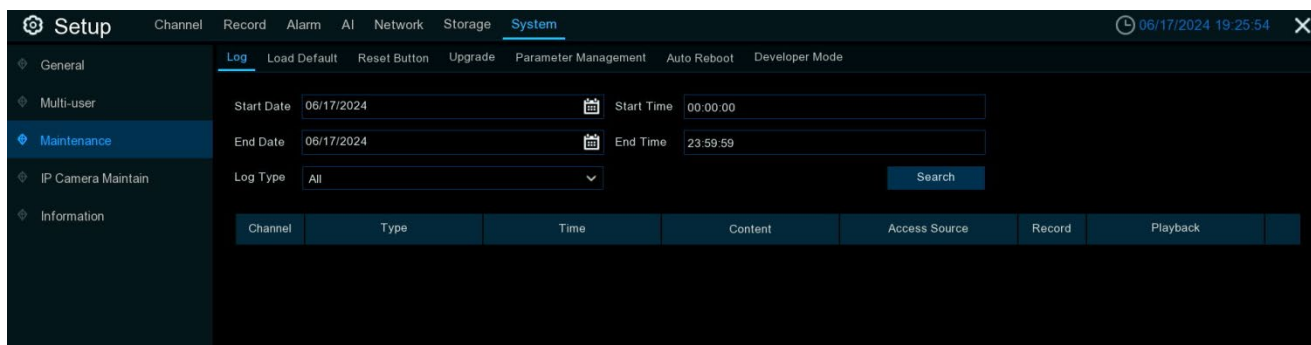

5.7.3.1 System Log

The NVR logs all system actions and detected events. These log files can be searched, viewed, and exported to a USB flash drive for backup purposes.

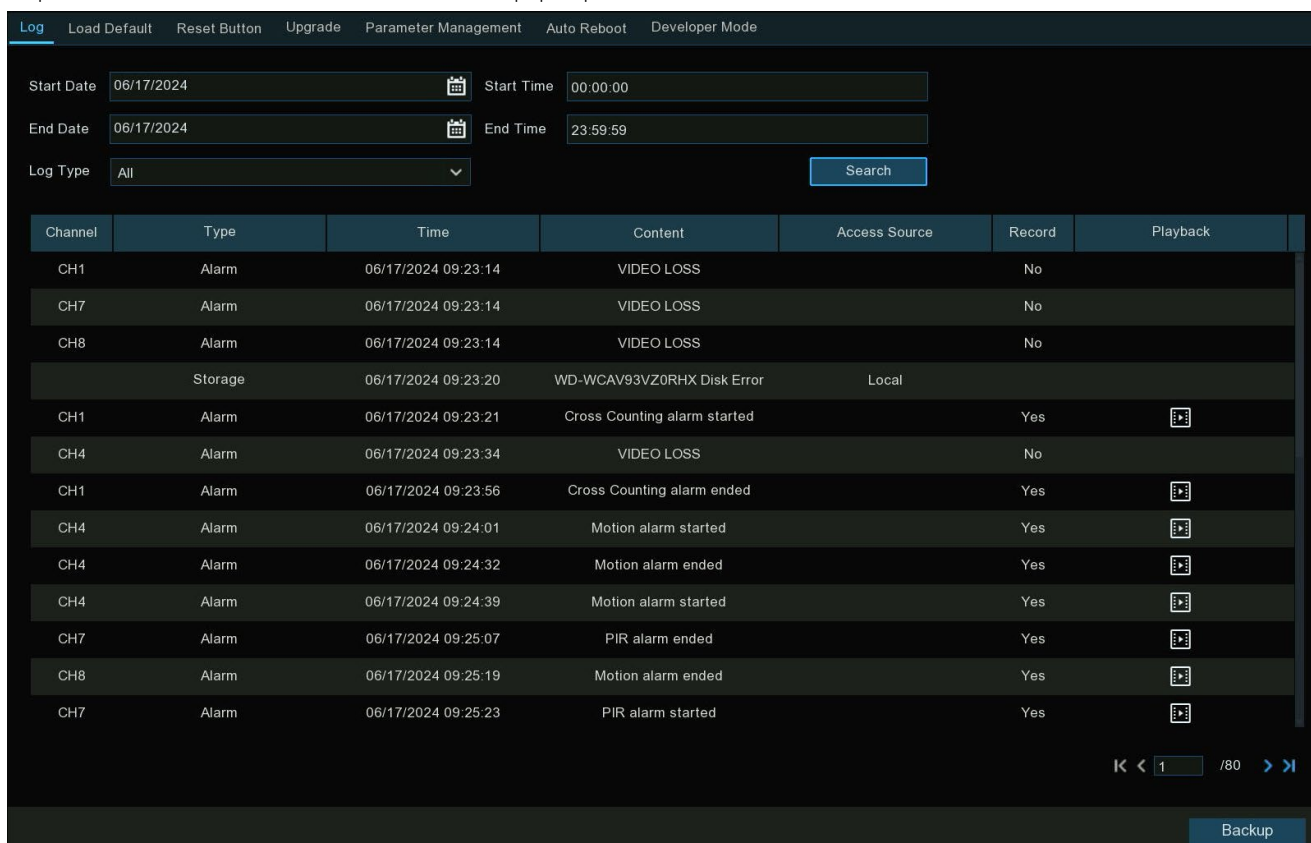

1. **Start/End Date & Start/End Time:** Click the calendar icon to select the month, year, and date for your search. Click the time dialogue box to specify the start and end times.
2. **Log Type:** Select "All" (default) or use the drop-down menu to choose a specific event type to search for:

- **System:** Logs related to system settings, reboots, auto-reboots, upgrades, time settings, and NTP time synchronization.
 - **Configuration:** Logs associated with parameter modifications and configurations, such as recording mode settings, recording schedule settings, network settings, image control, multi-user settings, etc.
 - **Alarm:** Alarm-related logs, including motion detection, AI alarms, and other alarm events.
 - **Account:** Records of local or external user logins and logouts.
 - **Record:** Logs of operations such as video search, playback, and backup.
 - **Storage:** Logs related to hard drive formatting, full hard drive alerts, and hard drive errors.
3. **Search:** Click to display a list of log files matching your search criteria. Double-click a file to view its details.
 4. **Playback:** Some alarm-related logs may be associated with event recordings. Click the play button  to view the video footage associated with the selected event.
 5. **Navigation buttons:** Use the arrow buttons at the bottom right corner of the page to navigate through the search results.
 6. **Backup:** Insert a USB flash drive into your NVR, then click this button to export log files that match your search criteria.

5.7.3.2 Load Default

In certain specific situations, such as when data anomalies or configuration errors occur after a system upgrade, or to rule out failures or instability caused by certain settings, you can try resetting the settings first. In these cases, you can use this function to restore the NVR to its factory default settings.

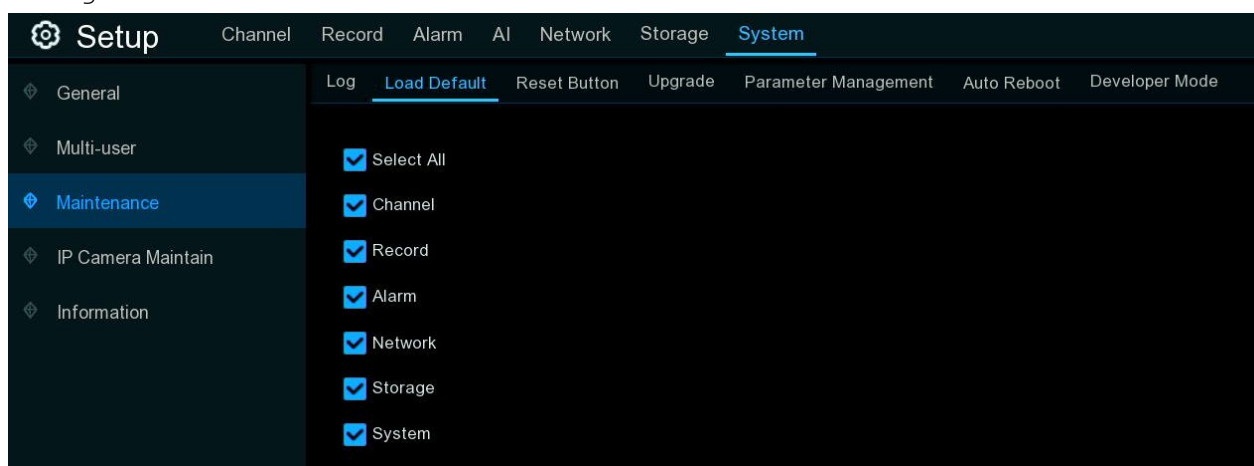

Checking the box(es) for the settings items you want to reset, and then clicking the "Apply" button, you can restore the corresponding settings of the NVR to their default out-of-the-box state.

This operation will not delete recorded video data and snapshot images, as this important data will be retained on the NVR's hard drive

5.7.3.3 Reset Button

Some models have a Reset button on the rear panel to restore factory settings. Press and hold this button for 10 seconds to restore the NVR to its factory settings. This button is typically used when you forget the user password.

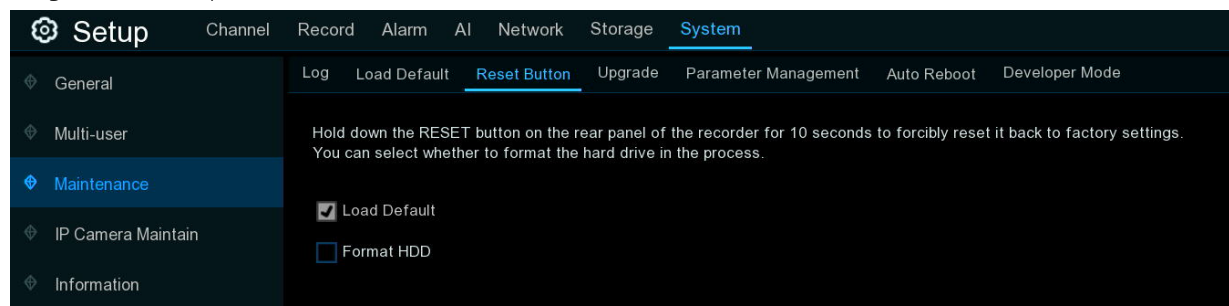

Format HDD: If checked, using the Reset button to restore factory settings will format the hard disk drive(s). Please check this option with caution.

5.7.3.4 Upgrade

You can upgrade the firmware either by using a USB flash drive or online.

Please note that for some firmware versions, you may need to manually restore the NVR to factory default settings after the upgrade. Be sure to confirm this with your dealer/vendor before proceeding with the upgrade.

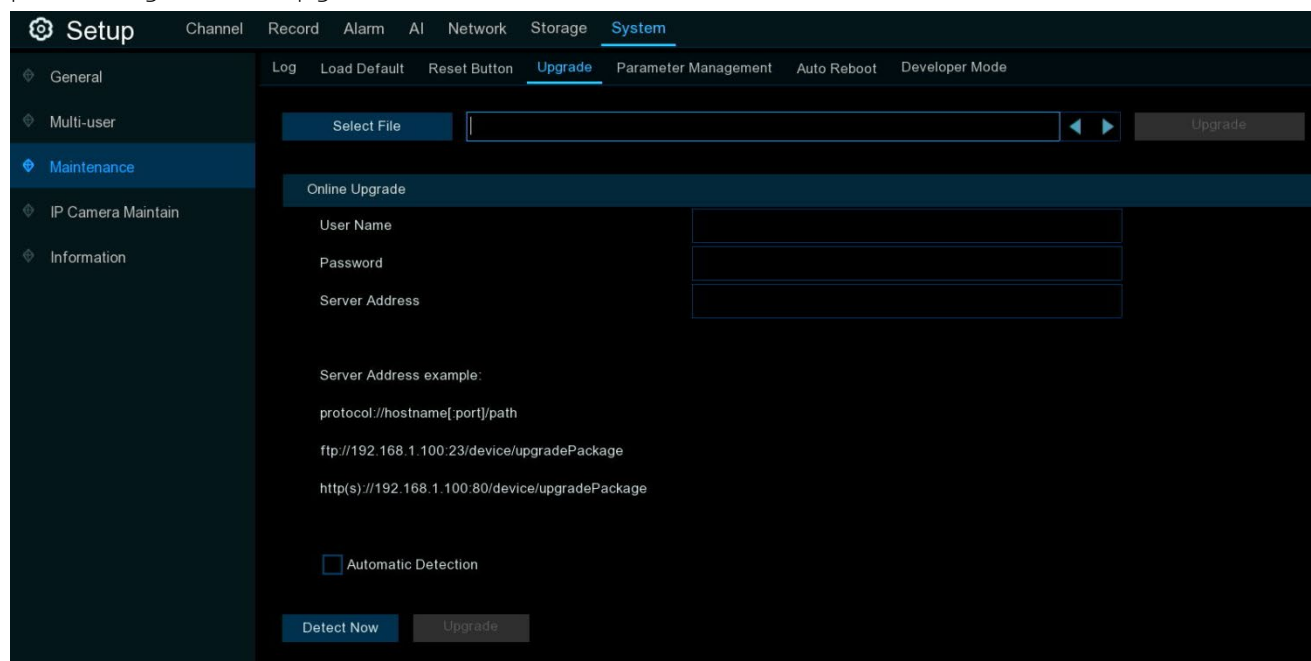

5.7.3.4.2 Online Upgrade

The device supports over-the-air (OTA) firmware upgrades. To use this function, you need to set up the upgrade server in advance, and correctly fill in the following information:

Username: Used to set the server user name. If the server is not configured with a user account, this parameter can be left blank.

Password: Used to set the server password. If the server is not configured with a password, this parameter can be left blank.

Server Address: Used to specify the server address. You need to set the upgrade address to the directory where the upgrade files are stored. Currently, both FTP and HTTP(S) transfer protocols are supported. The correct format is: protocol://hostname:port/path. For example:

- If the server protocol is FTP, the server IP address is 192.168.1.100, the server port is 23, and the folder for storing files is named "upgradepackage", then you should enter: ftp://192.168.1.100:23/upgradepackage in the address field.
- If the server protocol is HTTP, the server IP address is 192.168.1.100, the server port is 80, and the folder for storing files is named "upgradepackage", then you should enter: http://192.168.1.100:80/upgradepackage in the address field.
- If the server protocol is HTTPS, the server IP address is 192.168.1.100, the server port is 443, and the folder for storing files is named "upgradepackage", then you should enter: https://192.168.1.100:443/upgradepackage in the address field.

When a new upgrade file is available, copy the firmware file with the .sw extension to the specified directory on the upgrade server.

After the server is configured correctly, check "**Automatic Detection**". The device will then periodically check for any available firmware upgrades from the server during startup and operation. If an

upgradeable firmware is found, a prompt message will be displayed to notify the user to proceed with the upgrade.

You can also click the "**Detect Now**" button to manually check if the server has any upgradeable firmware available. When it is detected that the server has an upgradeable firmware, the "**Upgrade**" button becomes available. Click it to confirm and initiate the upgrade process on the NVR.

5.7.3.5 Parameter Management

Users can export the currently configured parameter file to a USB drive, or import a previously exported parameter configuration file from a USB drive to an NVR of the same model. Using this function, you can copy the same configuration parameters to multiple NVRs.

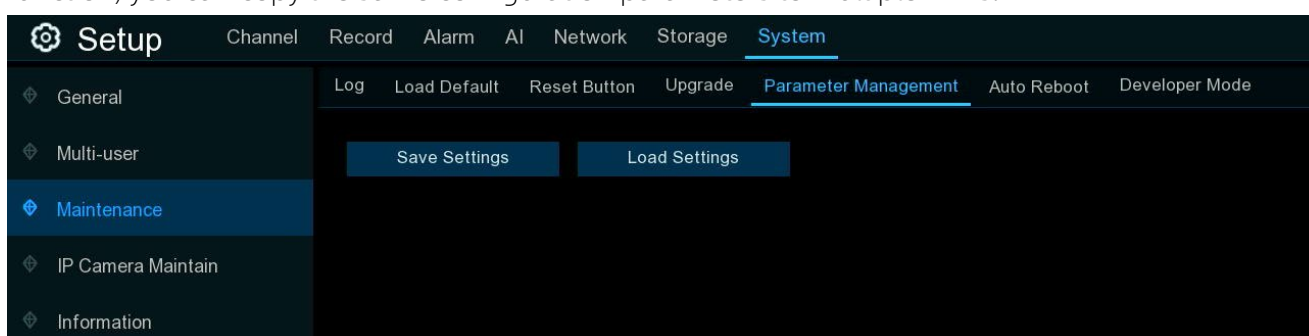

Save Settings: Save the current device system configuration parameters to the specified USB storage directory.

Load Settings: Import the configuration parameters from the USB storage directory to the current device. After importing, the device will automatically restart.

5.7.3.6 Auto Reboot

This menu allows the system to automatically reboot the NVR regularly. It is recommended to leave this function enabled, as it helps maintain the operational integrity of your NVR.

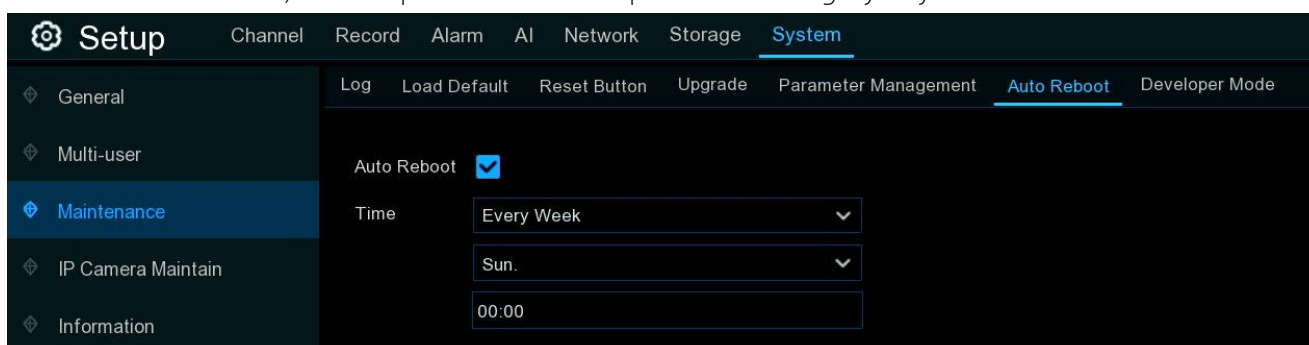

Auto Reboot: Check the box to enable this feature.

Time: You can set the NVR to reboot daily, weekly, or monthly.

5.7.3.7 Developer Mode

This is an advanced feature on certain NVR models. When you report a defect, authorized professionals may request you to perform certain operations to obtain the NVR's internal debug logs after reproducing the issue. This helps them quickly locate and identify the problem.

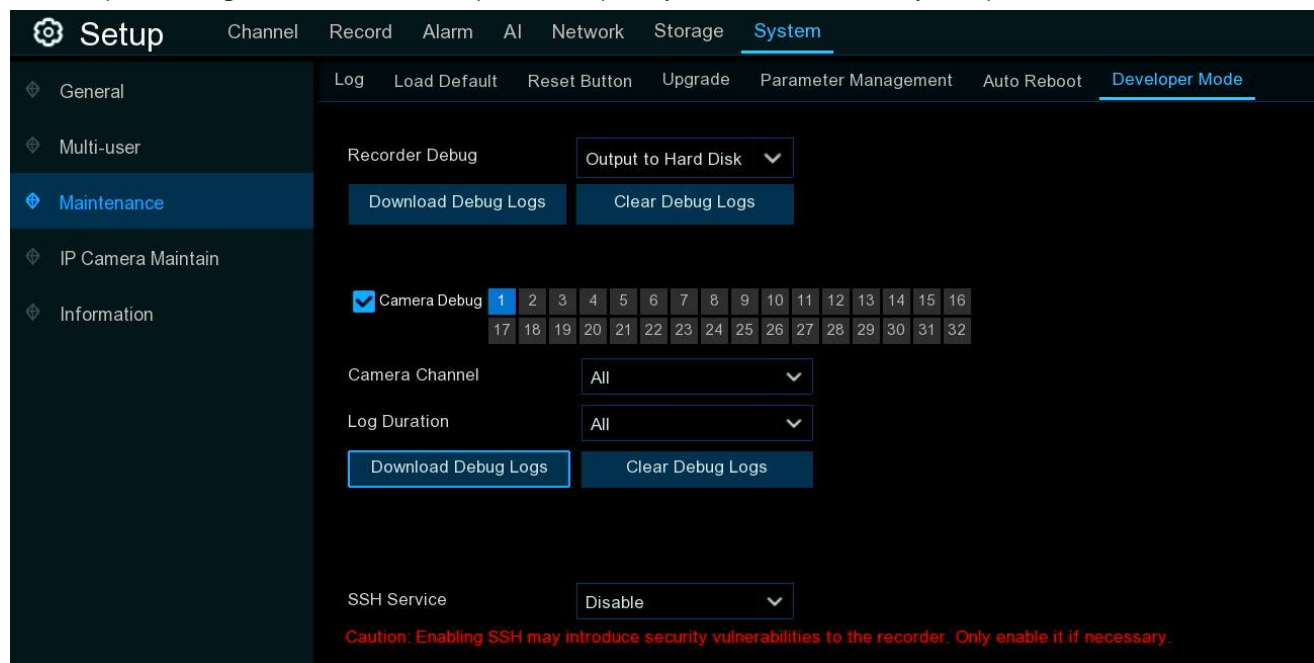

In this menu, you can manage the debug logs for both the NVR and IP cameras. The detailed instructions are as follows:

1) For NVR



In the "Recorder Debug" menu, the default setting is Disabled, meaning the system will not generate debug logs. Follow the instructions of authorized professionals to select the appropriate logging method:

- **Output to Terminal:** Debug logs will be output to the terminal port.
- **Output to Disk:** Debug logs will be saved to the hard disk drive.

After reproducing the issue and generating sufficient debug logs, use the "Download Debug Logs" button to save the generated log files to a USB drive, and then send them to the authorized professionals for further analysis.

After the issue has been resolved, use the "Clear Debug Logs" button to delete the generated logs. Then, set the "Recorder Debug" menu to Disabled to complete this process.

2) For IP Cameras

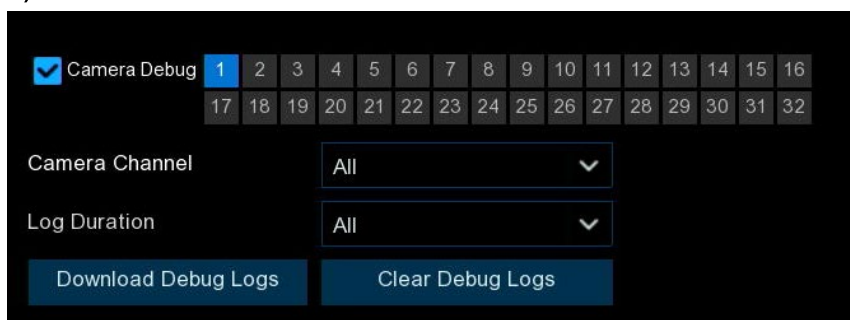

The system supports collecting debug logs from cameras through the NVR (this feature requires camera support) and exporting them to a USB drive. In the "**Camera Debug**" menu, the system will, by default, enable this feature for all cameras that support it. If a channel number is grayed out, it indicates that the camera does not support this feature.

In the "**Camera Channel**" menu, select the channel(s) for which you need to export the debug log. Then, choose the log duration in the "**Log Duration**" field. Click the "**Download Debug Logs**" button to save the log files to a USB drive. After exporting the logs, you can use the "**Clear Debug Logs**" button to delete the generated logs.

5.7.4 IP Camera Maintain

You can perform routine management and maintenance on IP cameras through the NVR, such as upgrading, resetting, rebooting the camera, importing/exporting parameters, and formatting the camera's memory card.

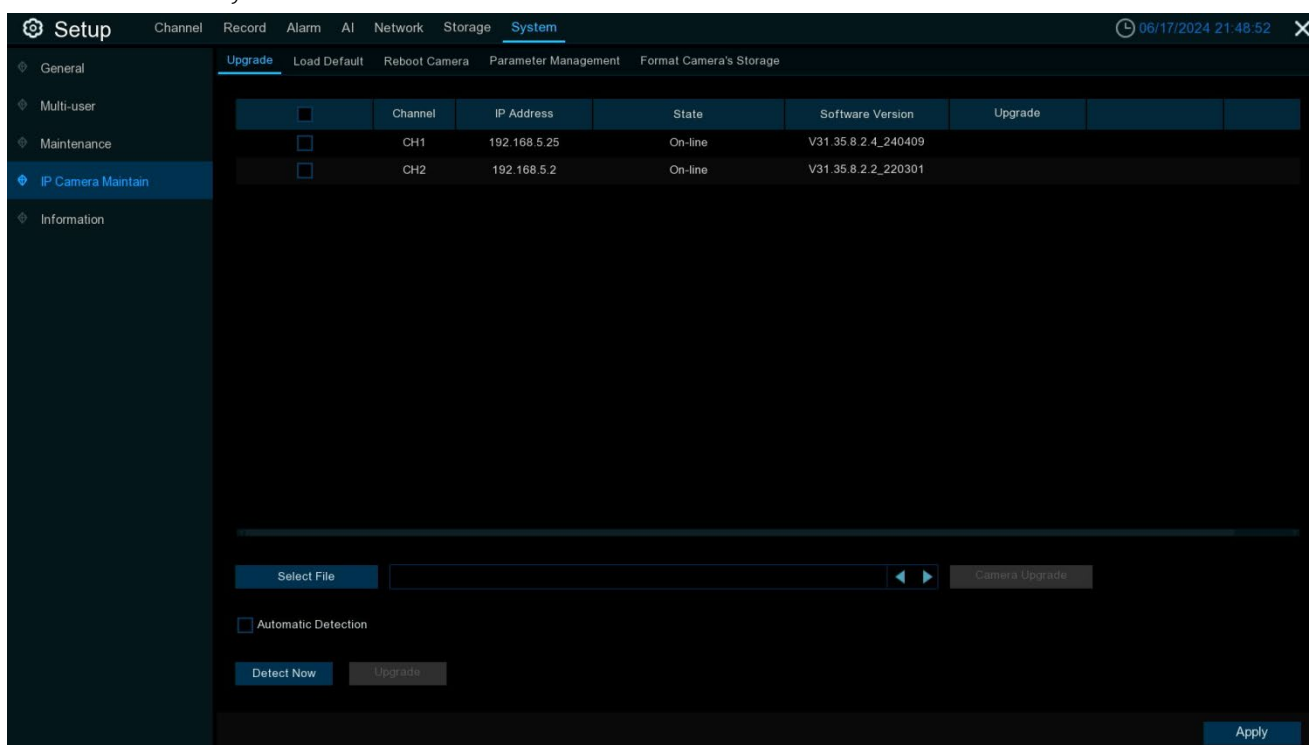

5.7.4.1 Upgrade IP Cameras

The screenshot shows the 'Upgrade' tab in the NVR web interface. At the top, there are navigation links: Upgrade (selected), Load Default, Reboot Camera, Parameter Management, and Format Camera's Storage. Below these is a table with the following data:

<input checked="" type="checkbox"/>	Channel	IP Address	State	Software Version	Upgrade
<input checked="" type="checkbox"/>	CH1	192.168.5.25	On-line	V31.35.8.2.4_240409	
<input checked="" type="checkbox"/>	CH2	192.168.5.2	On-line	V31.35.8.2.2_220301	

Below the table, there is a 'Select File' button, a file input field, and a 'Camera Upgrade' button. There is also an 'Automatic Detection' checkbox and 'Detect Now' and 'Upgrade' buttons.

1. Select the individual or multiple IP cameras of the same model that you wish to upgrade
2. Click the "Select File" button to choose the update file from your USB flash drive, then click "OK".
3. Click the "Camera Upgrade" button to start the upgrade process. You will be required to input the Admin's password to authenticate. Please DO NOT power off the NVR or the IP camera(s), or remove the USB drive during the upgrade.
4. After the upgrade is complete, the IP camera(s) will automatically restart.

For certain IP cameras that support online upgrades, you can tick "Automatic Detection" to automatically check for upgrade files from the server at regular intervals. Click the "Detect Now" button to check if new firmware is available instantly. If new firmware is available, click the "Upgrade" button and follow the on-screen instructions.

5.7.4.2 Load Default Settings for IP Cameras

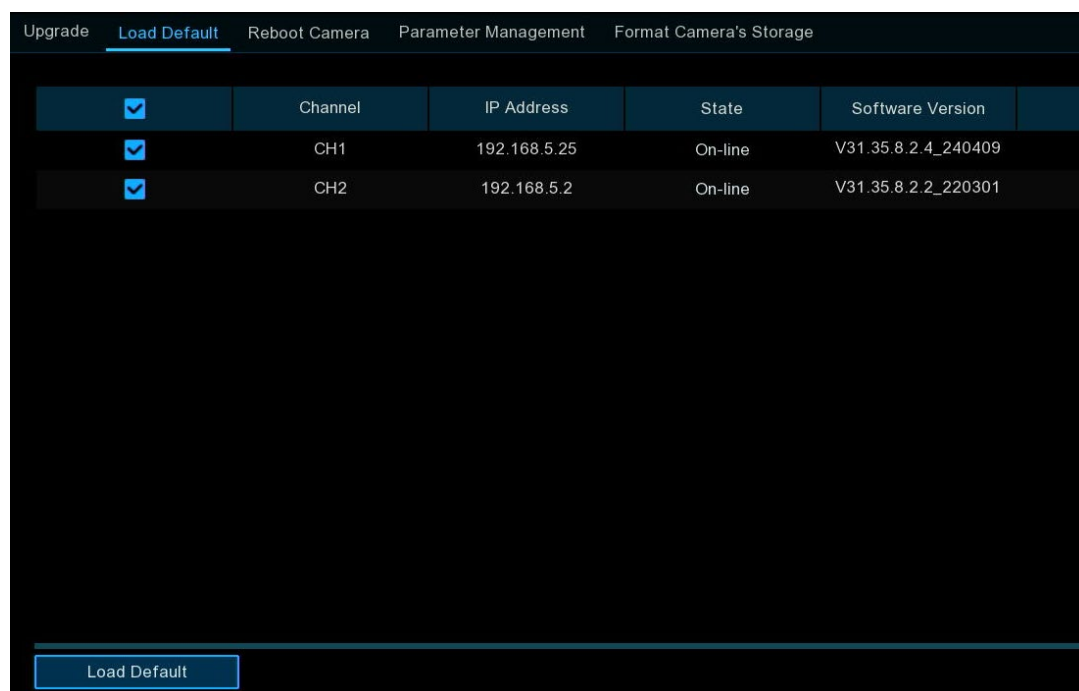

The screenshot shows the 'Load Default' tab selected in the top navigation bar. Below the navigation bar is a table with columns for Channel, IP Address, State, and Software Version. Two channels are listed: CH1 and CH2. Both channels have checkboxes in the first column, which are currently checked. At the bottom of the interface, there is a 'Load Default' button.

<input checked="" type="checkbox"/>	Channel	IP Address	State	Software Version
<input checked="" type="checkbox"/>	CH1	192.168.5.25	On-line	V31.35.8.2.4_240409
<input checked="" type="checkbox"/>	CH2	192.168.5.2	On-line	V31.35.8.2.2_220301

1. Choose the IP camera(s) you want to restore.
2. Click [Load Default](#) to restore settings. You will be required to input the Admin's password to authenticate.

5.7.4.3 Reboot IP Cameras

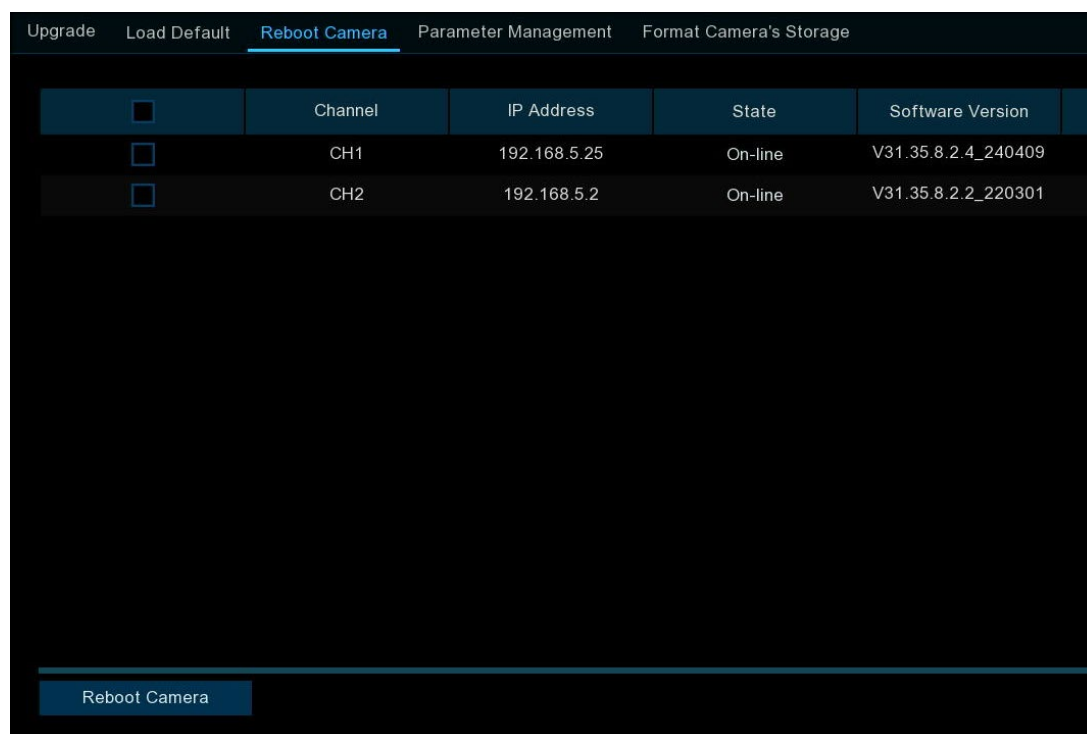

The screenshot shows the 'Reboot Camera' tab selected in the top navigation bar. Below the navigation bar is a table with columns for Channel, IP Address, State, and Software Version. Two channels are listed: CH1 and CH2. Both channels have checkboxes in the first column, which are currently unchecked. At the bottom of the interface, there is a 'Reboot Camera' button.

<input type="checkbox"/>	Channel	IP Address	State	Software Version
<input type="checkbox"/>	CH1	192.168.5.25	On-line	V31.35.8.2.4_240409
<input type="checkbox"/>	CH2	192.168.5.2	On-line	V31.35.8.2.2_220301

In case of any issues, choose the camera(s) and then click "[Reboot Camera](#)" button to reboot selected camera(s).

5.7.4.4 Parameter Management

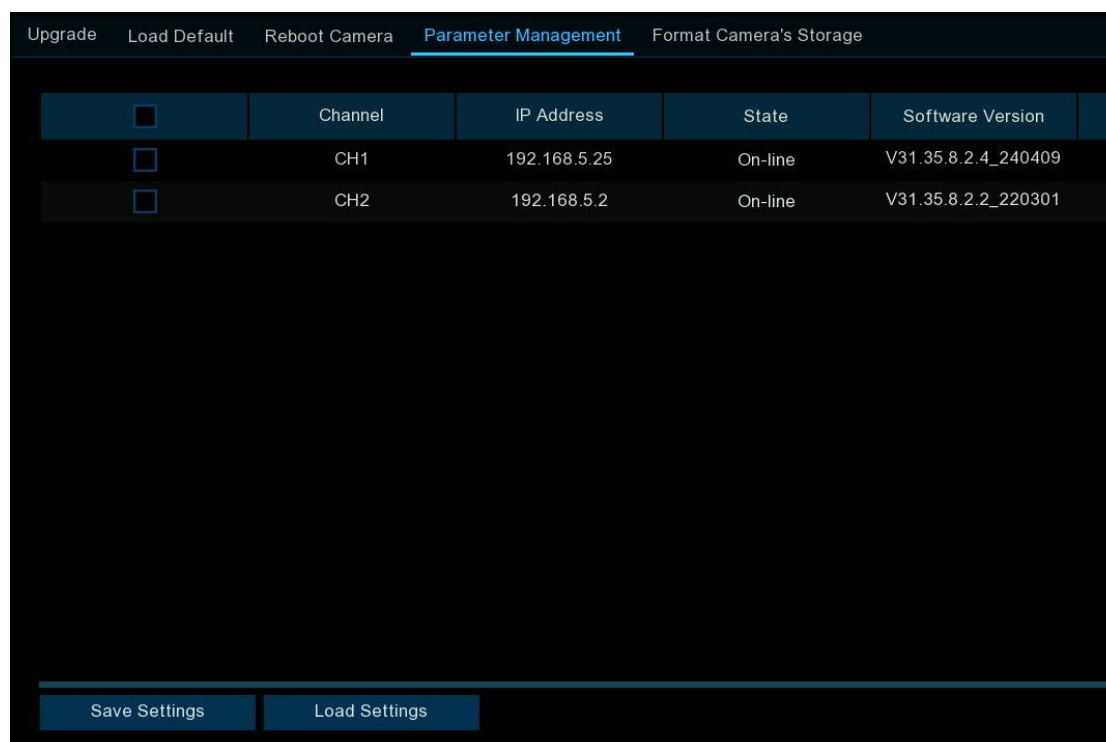

- Select the camera(s), and then click the "Save Settings" button to export the configuration file containing all the settings that you have customized to your USB flash drive.
- To load settings, click the "Load Settings" button to import a configuration file containing all the customized settings and apply them to the selected camera(s). Please refrain from performing this operation across different models or versions, as it may cause parameter discrepancies.

5.7.4.5 Format Camera's Storage

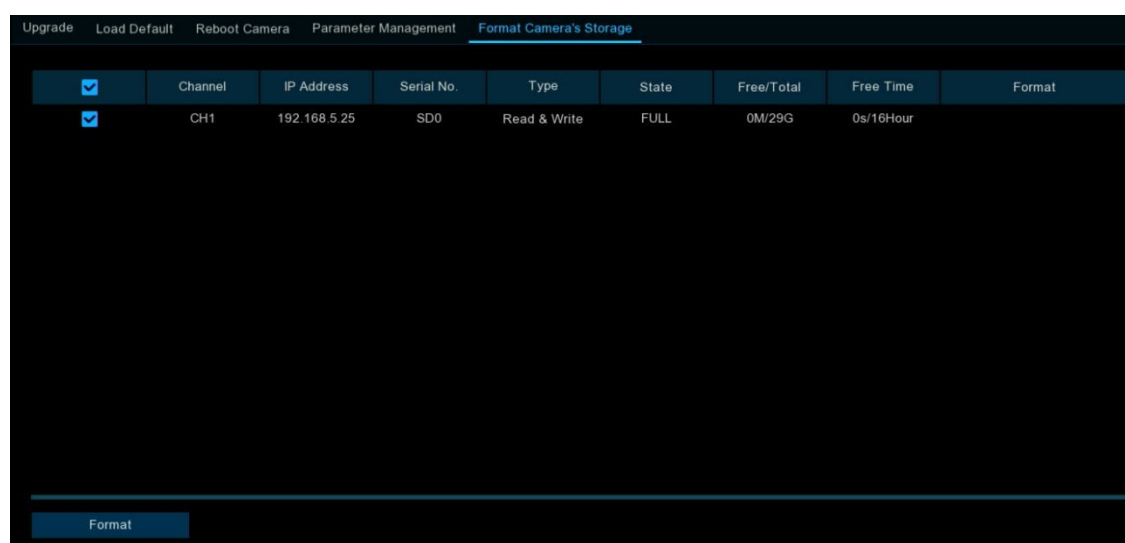

For IP cameras connected to the NVR via HTTP port, the NVR can format the memory card installed in the camera. After selecting the camera(s) that need formatting, clicking the "Format" button will initiate the formatting of the SD card in the network camera.

5.7.5 System Information

In this menu, you can view basic information about the NVR, such as device model, firmware version, channel details, network parameters, and more.

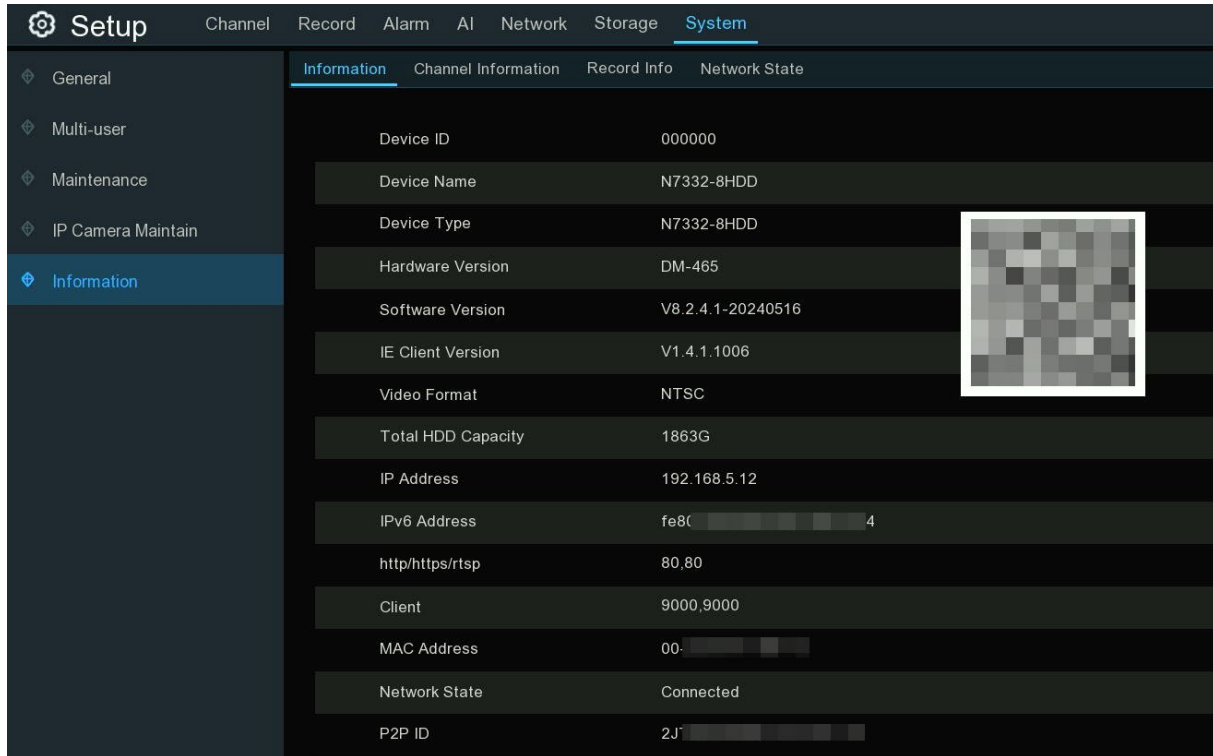

5.7.5.1 Information

This menu displays technical information about your NVR, including hardware and software versions, IP address, network ports, MAC address, and other relevant details.

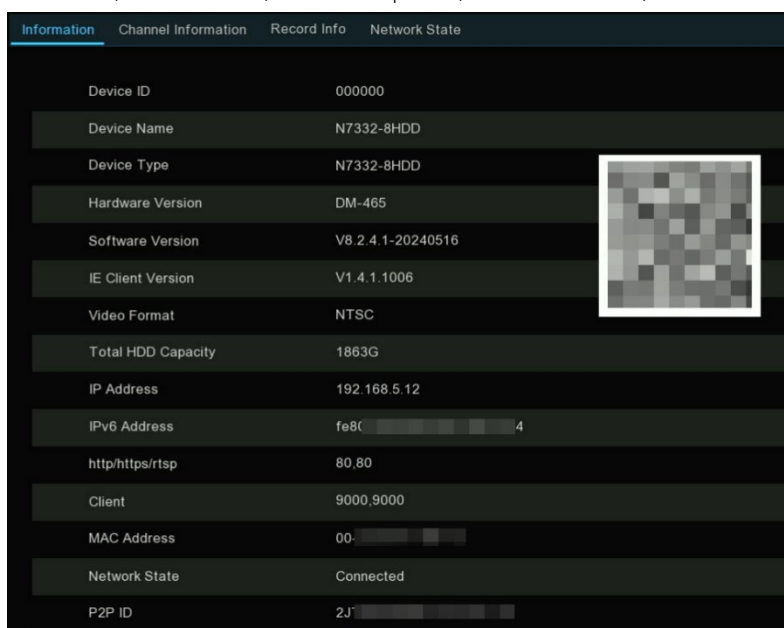

If your NVR supports P2P functionality, you will find the P2P ID and P2P QR code on the information page. You can scan this QR code with a mobile app to remotely view the NVR.

5.7.5.2 Channel Information

View channel information for each connected camera.

Channel	Alias	State	Mainstream	Substream	Mobile Stream	Motion Detection	Privacy Zone
CH1	CH1	On-line	1920x1080, 25Fps, 4Mbps	1280x 720, 25Fps, 1024Kbps	640x 480, 25Fps, 512Kbps	Available	Available
CH3	CH3	On-line	3840x2160, 30Fps, 6Mbps	1280x 720, 30Fps, 1.5Mbps	640x 480, 30Fps, 512Kbps	Available	Available
CH5	CH5	On-line	1920x1080, 30Fps, 4Mbps	1280x 720, 30Fps, 1024Kbps	640x 480, 30Fps, 512Kbps	Available	Available
CH7	CH7	On-line	2592x1944, 15Fps, 4Mbps	640x 480, 10Fps, 1024Kbps	N/A	Available	Available
CH8	CH8	On-line	1920x1080, 30Fps, 2Mbps	1280x 720, 30Fps, 1024Kbps	640x 480, 30Fps, 512Kbps	Available	Available

5.7.5.3 Record Information

View recording information for each connected camera such as bitrate, stream type, recording resolution and frame rate (FPS).

Channel	Record State	Switch	Stream Type	Resolution	Frame Rate	Bitrate
CH1	ON	Enable	Dual Stream	1920x1080 1280x720	25fps 25fps	4Mbps 1024Kbps
CH3	ON	Enable	Dual Stream	3840x2160 1280x720	30fps 30fps	6Mbps 1.5Mbps
CH5	ON	Enable	Dual Stream	1920x1080 1280x720	30fps 30fps	4Mbps 1024Kbps

5.7.5.4 Network State

Displays the network settings configured for your NVR.

Item	Value
WAN	
DHCP	Enable
IP Address	192.168.1.100
Subnet Mask	255.255.255.0
Gateway	192.168.1.1
IPv6 Address	fe80::223:63ff:fe91:5bfc / 64
IPv6 Gateway	fe80::/64
MAC Address	00-23-63-91-5B-FC
DNS1	192.168.5.1
DNS2	8.8.8.8
Internal Switch	
IP Address	10.10.25.100
Subnet Mask	255.255.0.0
PPPoE	Disable
Port	
http/https/rtp	80,80,Inactive,Disable
Client	9000,9000,Inactive,Disable
Total Bandwidth:	256Mbps
Used Bandwidth:	27.5Mbps

Chapter 6 AI Scenario

The AI Scenario function offers AI applications tailored for specific scenarios. Click on the submenu title on the main setup page to access the setup page for each individual function.

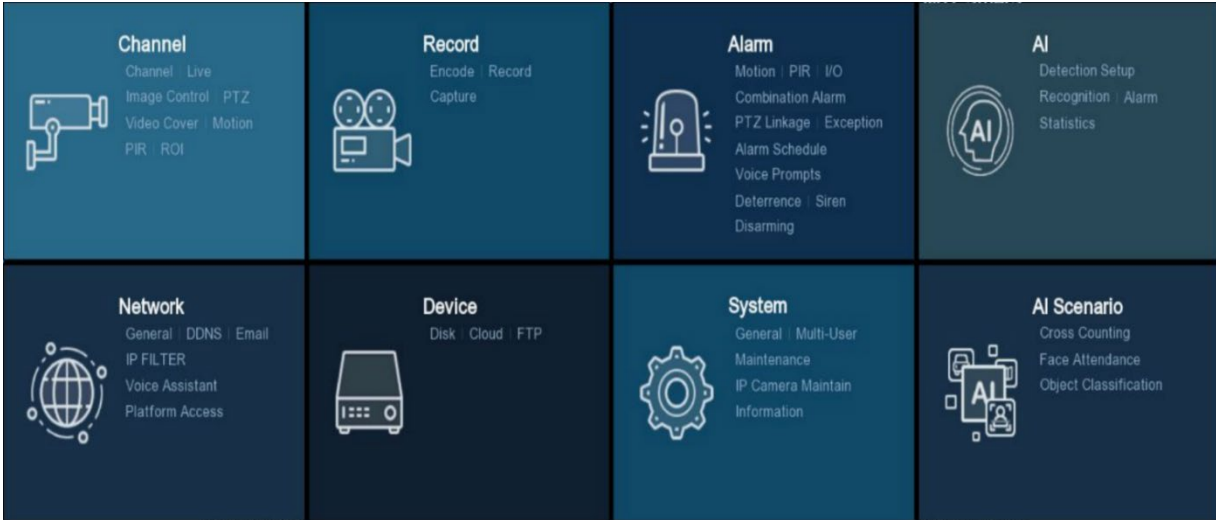

6.1 Cross Counting

This AI application is based on cross-counting functionality. By setting a maximum allowed number of people in specific locations and combining the detected numbers of entries and exits from single or multiple cameras, it calculates the number of people who can still enter the location, thereby achieving crowd control. This feature is designed to effectively manage and monitor attendance numbers in various public places such as restaurants, parks, zoos, theaters, museums, and car parks, utilizing different viewing modes and providing detailed real-time and statistical data to avoid overcrowding and other unexpected situations.

The screenshot displays the cross-counting interface. It features four live camera feeds (CH1, CH2, CH6, CH7) showing a mall lobby. A central panel shows a green walking icon and the text 'Please Enter' with a count of 992 Available. Below this, it shows 8 Inside, 19 Enter, and 11 Exit. A table at the bottom right provides a detailed breakdown of the data.

Channel	Type	06:00	07:00	08:00	09:00	10:00	11:00
CH1	Enter	0	0	0	0	0	19
	Exit	0	0	0	0	0	11
	Inside	0	0	0	0	0	8
CH2	Enter	0	0	0	0	0	7
	Exit	0	0	0	0	0	3
	Inside	0	0	0	0	0	4
CH6	Enter	0	0	0	0	0	72
	Exit	0	0	0	0	0	68
	Inside	0	0	0	0	0	4
CH7	Enter	0	0	0	0	0	48
	Exit	0	0	0	0	0	30
	Inside	0	0	0	0	0	18

6.1.1 Introduction of Real-time Display & Controls

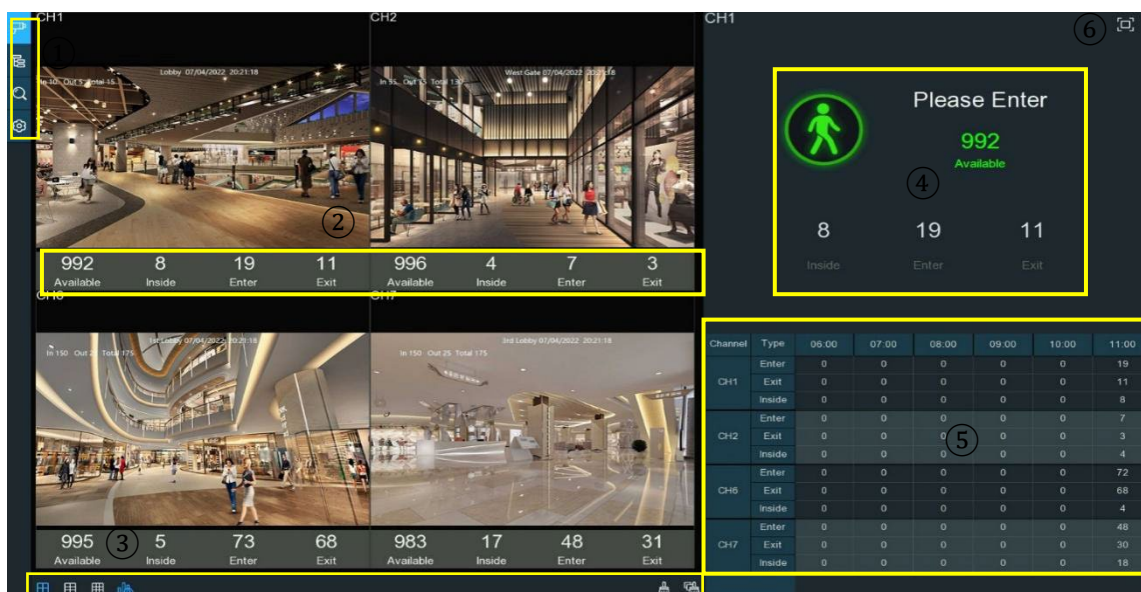





1. Navigation Bar

Icon	Item	Description
	Individual Mode	This mode counts and displays real-time results for individual cameras. It is suitable for small spaces with a single entrance and exit. Each camera's counting data is monitored and displayed separately.
	Grouped Mode	This mode counts and displays real-time results by groups, making it suitable for larger areas with multiple entrances and exits monitored by multiple cameras. The system aggregates the counting data from each camera within the group, calculating and integrating the entry and exit data to produce the overall real-time data for the entire group.
	Data Search	This function enables users to search for specific counting data, retrieve historical records, and analyze past attendance numbers based on specified criteria.
	Configuration	This option allows users to configure and adjust settings related to the counting system. Users can set parameters such as counting thresholds, display preferences, and notification settings to customize the system according to specific operational requirements.

2. Real-time Counting Statistics



Item	Description
Available	Remaining allowed attendance number
Inside	Current attendance number inside the controlled area
Enter	Total recorded number of entrants
Exit	Total recorded number of attendees leaving

3. Screen Display Controls

Icon	Item	Description
	Display Layout	Allows switching between different layout views for monitoring
	Data Display	Toggle to show or hide the real-time counting statistics
	Clear Channel Data	Resets counting data for a specific channel
	Clear All Channel Data	Resets counting data for all channels simultaneously

4. Real-time Counting Statistics Information Bar

This bar will display the real-time counting statistics for the selected channel.

Icon	Item	Description
-	Available	Remaining allowed attendance number
-	Inside	Current attendance number inside the controlled area
-	Enter	Total recorded number of entrants
	Exit	Total recorded number of attendees leaving
	Status indicator	If the available number is greater than 0, the cartoon figure will be displayed in green color to indicate clearance.
	Status indicator	If the available number is 0, the cartoon figure will be displayed in red color to indicate no entry.

5. Statistic Data Chart

The all-day counting statistical data for all activated channels will be displayed here. Use the mouse wheel to navigate through the timeline.

Channel	Type	09:00	10:00	11:00	12:00	13:00	14:00
CH1	Enter	0	0	34	48	29	21
	Exit	0	0	28	8	15	17
	Inside	0	0	6	46	60	64
CH2	Enter	0	0	38	5	28	42
	Exit	0	0	27	16	28	29
	Inside	0	0	11	0	0	13
CH6	Enter	0	0	183	53	239	296
	Exit	0	0	165	63	210	293
	Inside	0	0	18	8	37	40
CH7	Enter	0	0	134	47	152	197
	Exit	0	0	118	63	147	197
	Inside	0	0	16	0	5	5

6. Full Screen Display

Click  to expand the Real-time Counting Statistics Information Bar to full screen. Right-click to exit full screen mode.

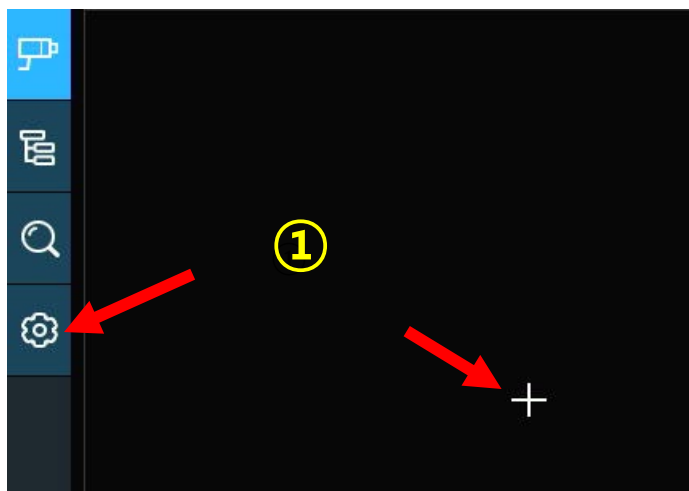

6.1.2 Settings of Individual Mode

1. Click the add icon  or setup icon  to go to the configuration page.

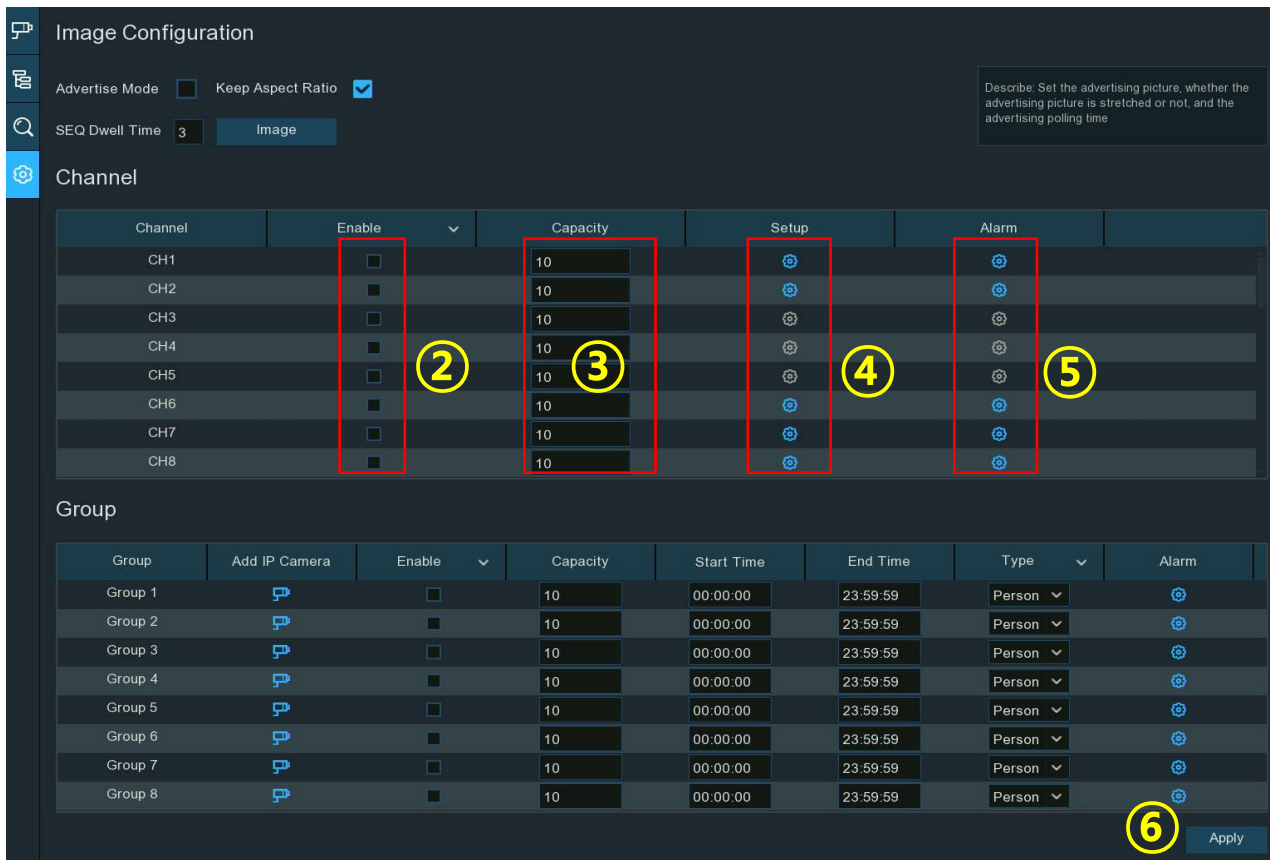

2. Tick the checkbox of "Enable" for the channel(s) where you want to enable counting. The Setup & Alarm icon  will appear in blue if the camera supports AI functions; conversely, if the camera does not support AI functions, the icon will be grayed out.



3. Set the "Capacity" number for each channel, which defines the maximum permitted occupancy.
4. Click the "Setup" button  of the camera to configure the detection conditions. Refer to section [5.4.1.5 Cross Counting](#) for more details.
5. Click the "Alarm" setup button  for the camera to configure alarm actions for when the Available number reaches 0.

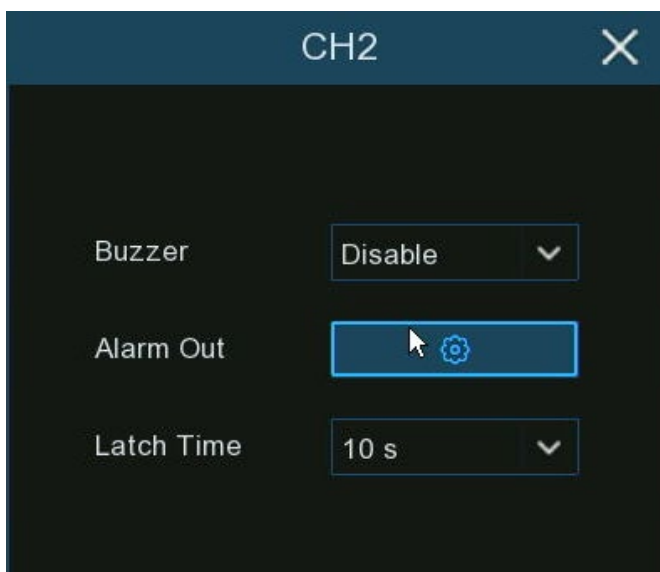

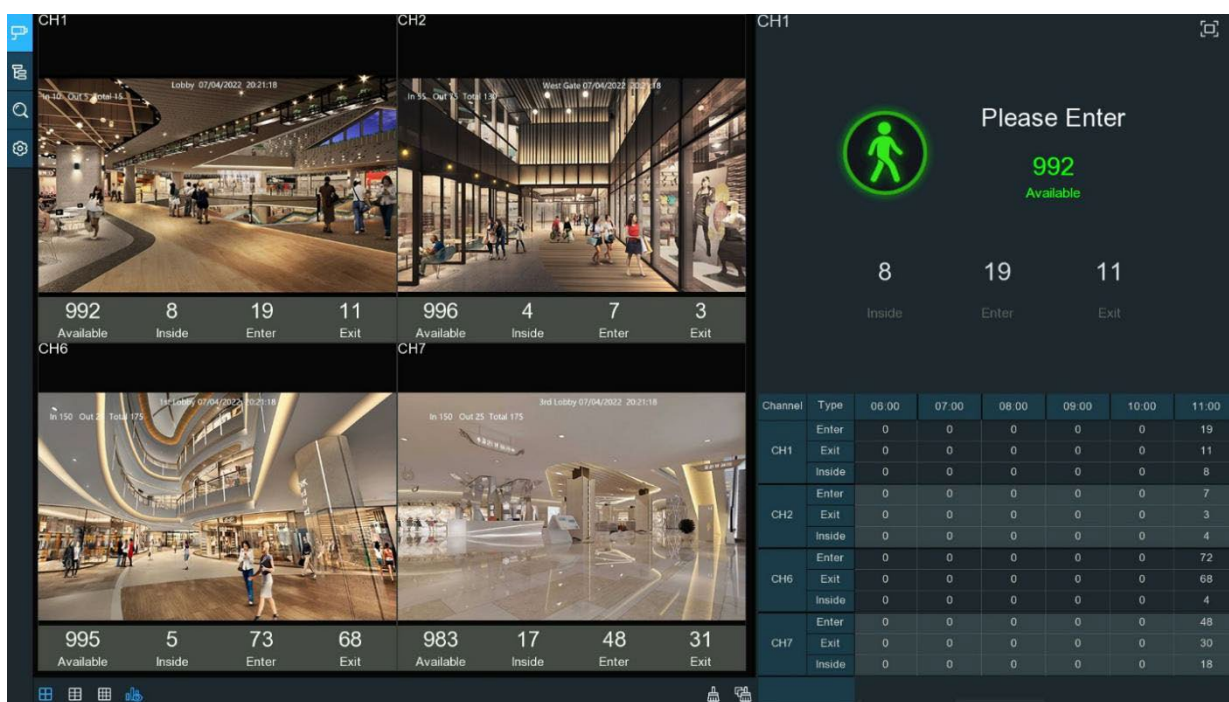

- **Buzzer:** Set the buzzer duration in seconds when the Available number is 0.
 - **Alarm Out:** If your NVR supports connecting to an external alarm device, you can set it to emit an alarm tone.
 - **Latch Time:** Set the duration for the external alarm when the Available number is 0.
6. Right-click to exit the alarm setup page, then click "Save" to save the changes.
 7. Click the Individual Mode icon  to view live images and counting data for all activated channels. You can view the current statistical data for each channel below the channel window. You can also click on any channel window to display its line crossing statistics in the top right corner of the screen.

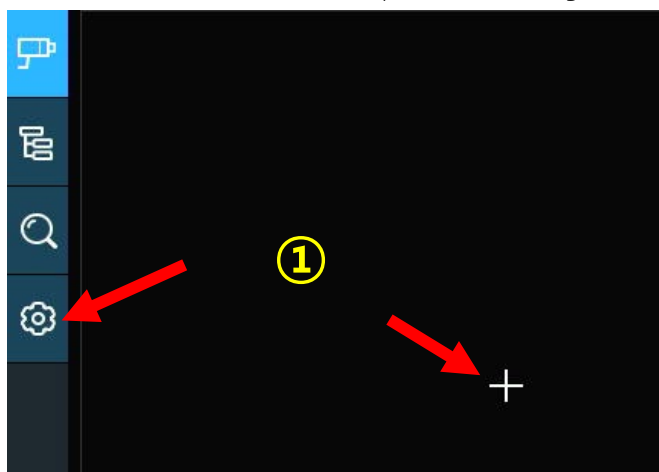

6.1.3 Settings of Grouped Mode

1. Click the add icon  or setup icon  to go to the configuration page.



- Click the add icon  to add channel(s) to the group. Max. 8 groups can be set, and each individual channel can be added to 1 group only. A maximum of 8 groups can be set, and each individual channel can only be added to 1 group. If a channel is enabled in Individual Mode, it will not be allowed to add to any group.

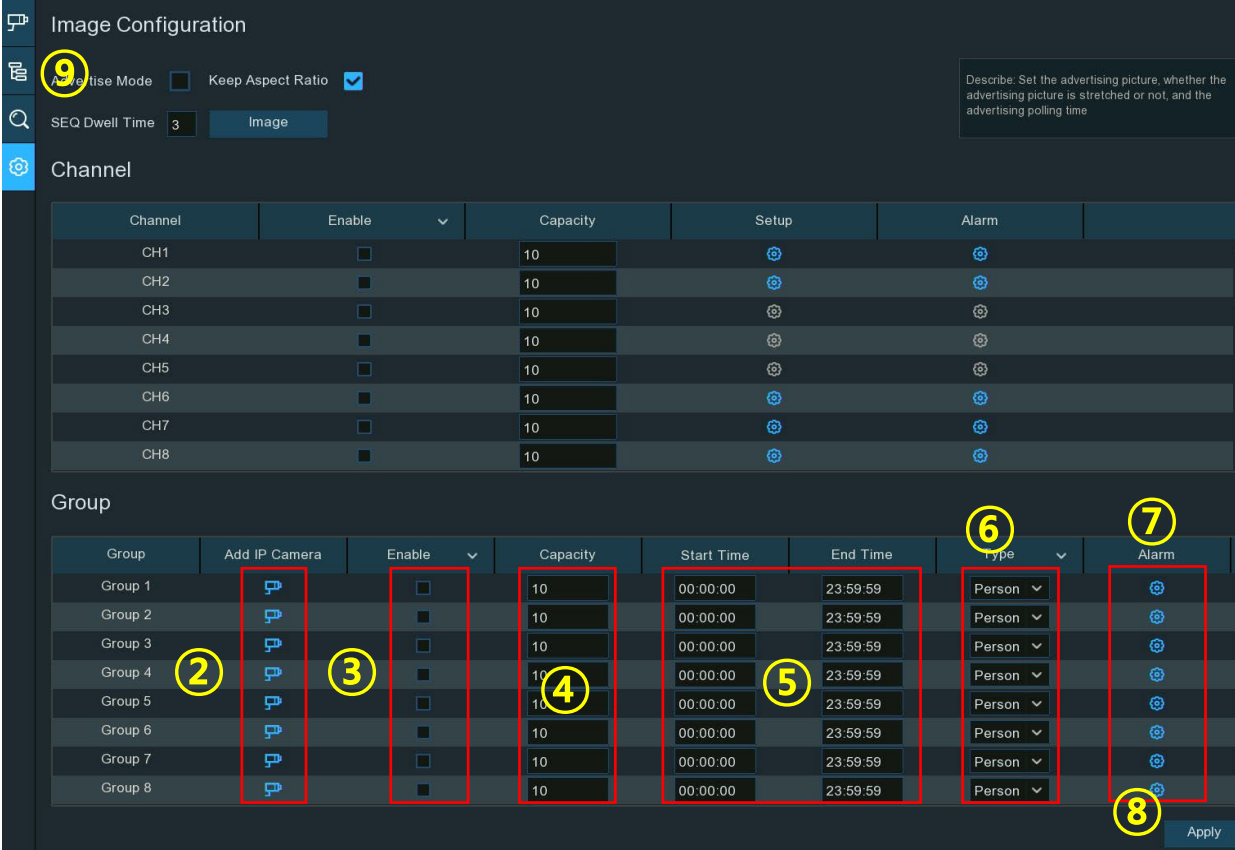

The screenshot shows the 'Image Configuration' interface. At the top, there are options for 'Individual Mode' (checked) and 'Keep Aspect Ratio' (checked). Below that is a search bar for 'SEQ Dwell Time' set to 3 and an 'Image' button. The main area is divided into 'Channel' and 'Group' sections.

Channel Table:

Channel	Enable	Capacity	Setup	Alarm
CH1	<input type="checkbox"/>	10		
CH2	<input checked="" type="checkbox"/>	10		
CH3	<input type="checkbox"/>	10		
CH4	<input checked="" type="checkbox"/>	10		
CH5	<input type="checkbox"/>	10		
CH6	<input checked="" type="checkbox"/>	10		
CH7	<input type="checkbox"/>	10		
CH8	<input checked="" type="checkbox"/>	10		

Group Table:

Group	Add IP Camera	Enable	Capacity	Start Time	End Time	Type	Alarm
Group 1		<input type="checkbox"/>	10	00:00:00	23:59:59	Person	
Group 2		<input checked="" type="checkbox"/>	10	00:00:00	23:59:59	Person	
Group 3		<input type="checkbox"/>	10	00:00:00	23:59:59	Person	
Group 4		<input checked="" type="checkbox"/>	10	00:00:00	23:59:59	Person	
Group 5		<input type="checkbox"/>	10	00:00:00	23:59:59	Person	
Group 6		<input checked="" type="checkbox"/>	10	00:00:00	23:59:59	Person	
Group 7		<input type="checkbox"/>	10	00:00:00	23:59:59	Person	
Group 8		<input checked="" type="checkbox"/>	10	00:00:00	23:59:59	Person	

At the bottom right, there is an 'Apply' button.

- Tick the checkbox of "Enable" for the group(s) you want to activate.
- Set the "Capacity" number for each group, which is the maximum permitted occupancy.
- Set the "Start/End Time" for each group.
- Choosing the detection target "Type" from **Person**, **Vehicle** or **Motion** allows you to specify which type of target the system should detect and count.
- Click the "Alarm" setup button  for the group that you want to configure the alarm actions for when the Available number is 0.

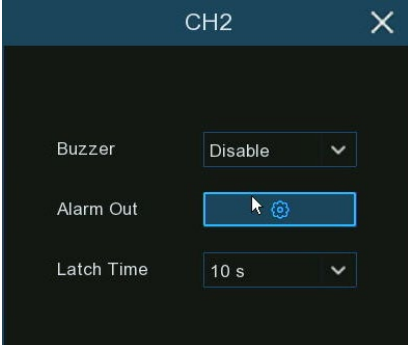

The screenshot shows a dialog box titled 'CH2' with a close button (X). It contains three settings:

- Buzzer: Disable
- Alarm Out:
- Latch Time: 10 s

- Buzzer:** Set the buzzer duration in seconds when the Available number is 0.

- **Alarm Out:** If your NVR supports connecting to an external alarm device, you can set it to emit an alarm tone.
 - **Latch Time:** Set the duration for the external alarm when the Available number is 0.
- Right-click to exit the alarm setup page, then click "Save" to save the changes.
 - Click the Grouped Mode icon  to view the live images and counting data for all activated groups.

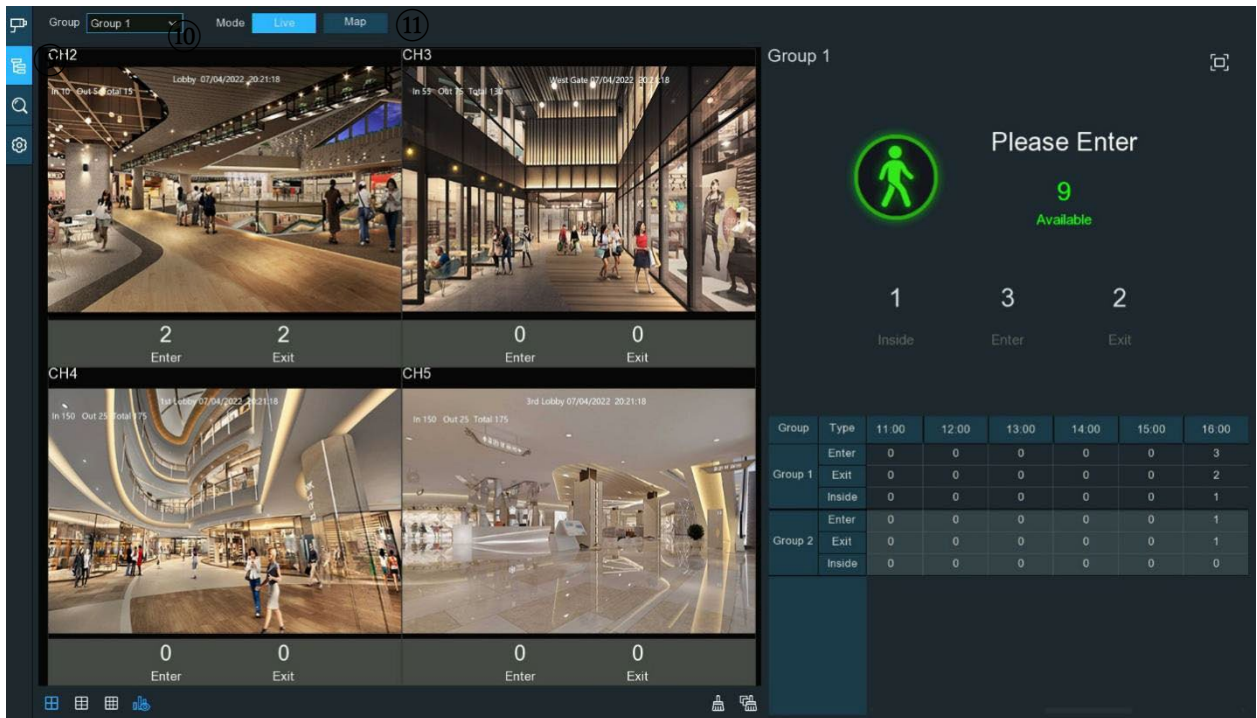



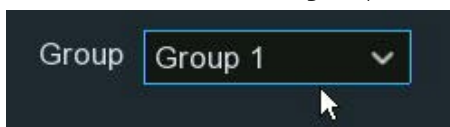

- You can choose which group to view the real-time live images and counting data for

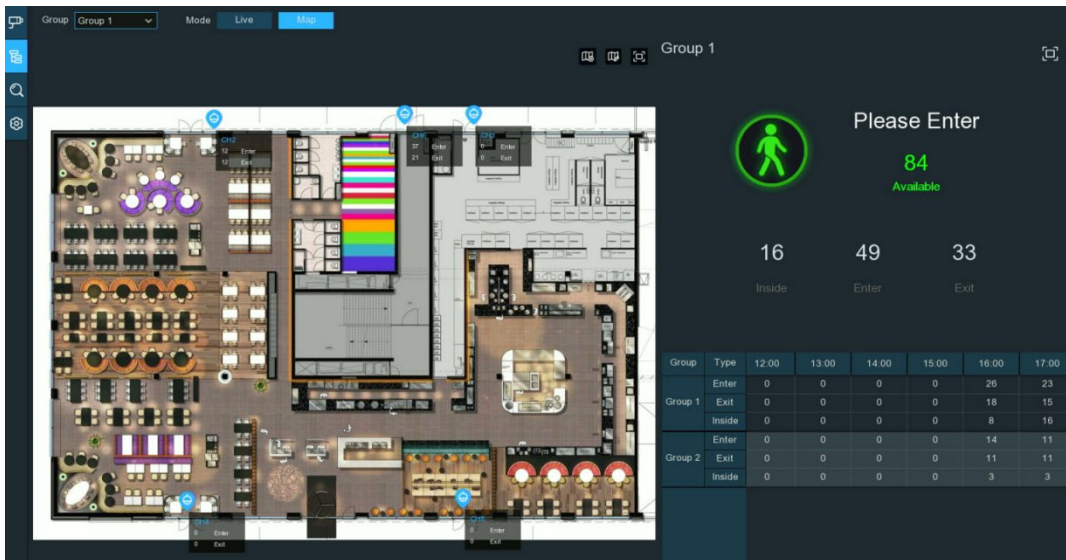

- Furthermore, it supports displaying the counting data in Map mode, which allows you to visually represent the counting data and camera positions on a map overlay for enhanced situational awareness and usability. Click the "Map" button to configure the settings.



- Click  button to add a map image from your USB drive.
- Click  button to adjust the positions of the IP cameras. Click and drag the channel icons to reposition them on the map.
- click  button to display the map in full screen, click  button to exit full screen.



6.1.4 Advertise Mode

The Advertise Mode enables businesses and retailers to display advertising images showcasing promotions, products, services or events alongside real-time people/vehicle traffic counting data. This integrated capability is particularly useful in scenarios like malls, exhibition halls, billboards at intersections, etc., where businesses not only want to monitor occupancy levels, but also showcase promotional content or disseminate information to potential customers while doing so.

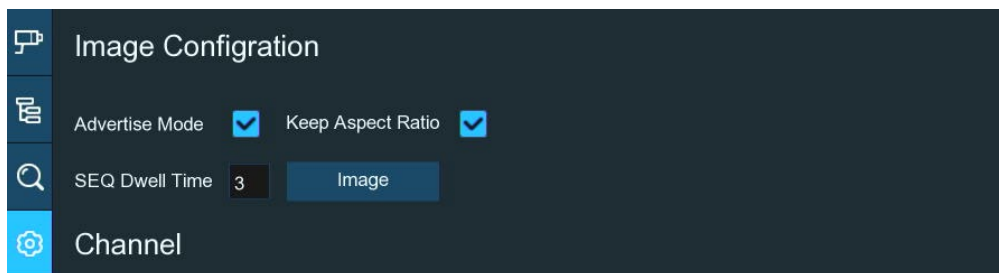

1. Click the Configuration button  in the Navigation bar to go to the configuration page.
2. Tick the checkbox of "Advertise Mode" to enable it.



3. Click the "Image" button to load advising pictures from your USB flash drive. You can add up to 16 images in JPG, PNG or BMP format with a maximum resolution of 2560x1600. Use the add  and delete button  to manage the image list. Click the close button  or right click your mouse to go back to previous configuration page.









4. Tick "Keep Aspect Ratio" if you want the images displayed in their original aspect ratio. Untick it to have the pictures stretched to full screen.
5. Set the "SEQ Dwell Time" in seconds to determine how long each picture stays on screen before cycling to the next one.
6. Click "Apply" button to save the advertising settings.
7. Go back to Individual Mode or Grouped Mode, and click the full screen button  on the right upper corner to display the advertising pictures alongside the real-time counting data.



6.1.5 Search Counting Data

The search function enables users to conveniently retrieve and view historical counting data for specified time periods, channels/groups, and target types according to their needs. The data can be presented in multiple formats, facilitating analysis and decision-making.







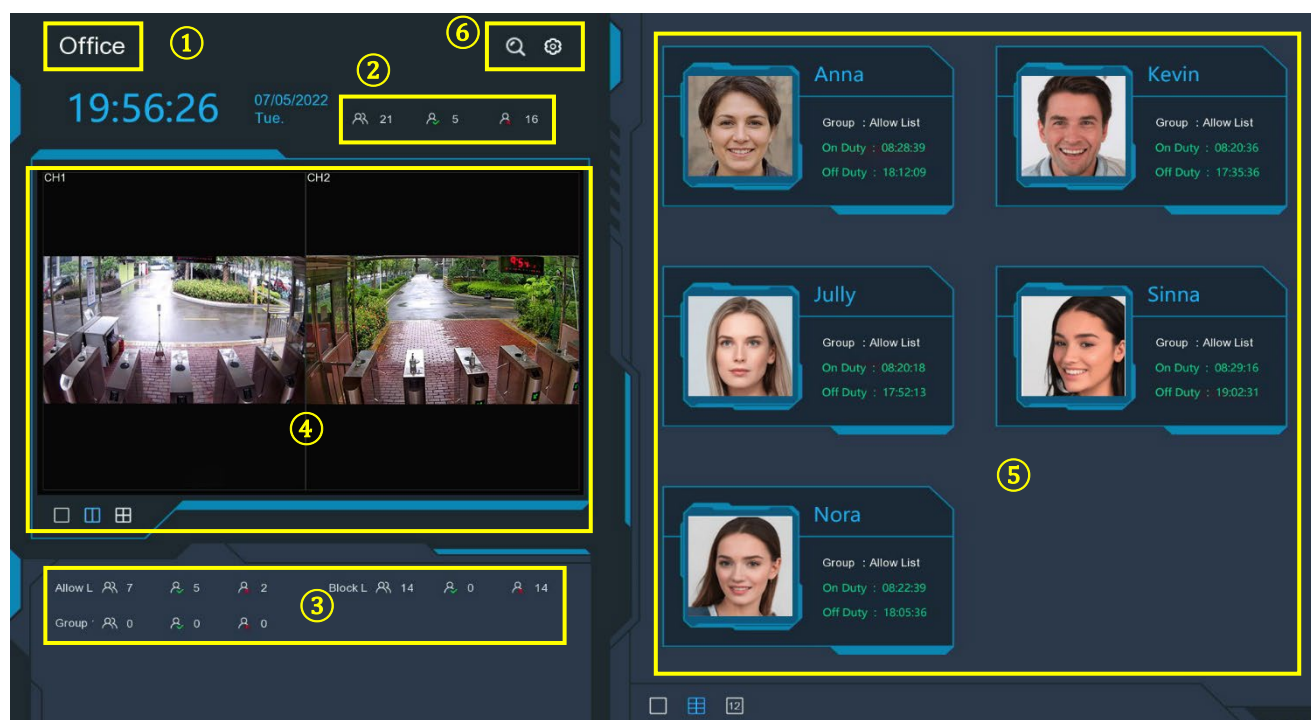

1. Click the "Search" button  in the Navigation bar to go to the search page.
2. You can search for Channels or Groups separately. Choose the channel(s) or group(s) you want to search, set the search duration by day, week, month or year, and then select the target type (pedestrian, vehicle, or motion) to search for.
3. Click the search button  at the bottom, and the results will be displayed on the right side of the window.
4. You can click different buttons to display the results in a column chart, trend chart, or detailed list view.
 -  Click to display the results in a column chart
 -  Click to display the results in a trend/line chart
 -  Click to display the results in a detailed list view
 -  Click to export the results into a USB flash drive

6.2 Face Attendance

Face Attendance is an AI application based on face detection functionality. It allows you to visually view and check real-time statistical data for attendance management.

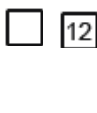

1. Display the customized title of the face attendance view.
2. Overall attendance statistics for all selected groups.
3. Individual attendance statistics for each selected group:
 -  The total number of people required to check attendance
 -  The number of people who have already checked in
 -  The number of people who have not checked in yet
4. Live view screen: Displays the live camera feeds. Click the screen split buttons  to change the layout. Click a button repeatedly to cycle through layout options.
5. Push notifications for the latest persons who have checked in, including the Name/ID, captured face image, group, clock in time, and clock out time. Normal check-in and check-out times are displayed in green, while abnormal times are shown in red. Click the screen split icons  to change the notification layout.
6. Click search icon  to search face attendance data. See section [7.9.6 Face Attendance](#) for more details.
7. Click Setting icon  to configure the face attendance settings:

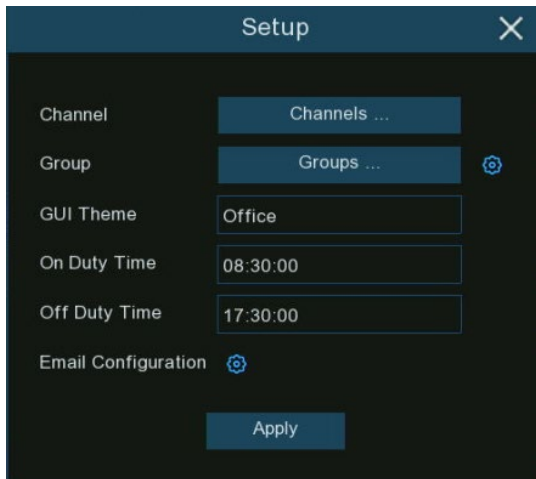

Channels: Click to choose the face attendance channel(s)

Group: Click to choose the face attendance group(s). To edit the group database, click the  icon. See section [5.4.2.2 Face Recognition Database Management](#) for more information.

GUI Theme: Customize the title for the face attendance view.

On Duty Time: Set the start time for the on-duty period.

Off Duty Time: Set the end time for the on-duty period.

Email Configuration: Send attendance statistics via email. Click the  icon to edit email settings:

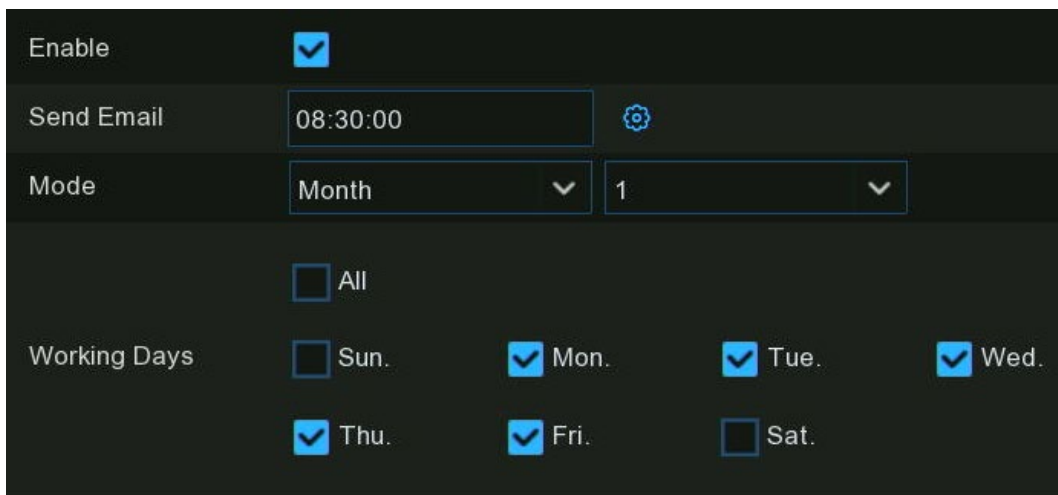







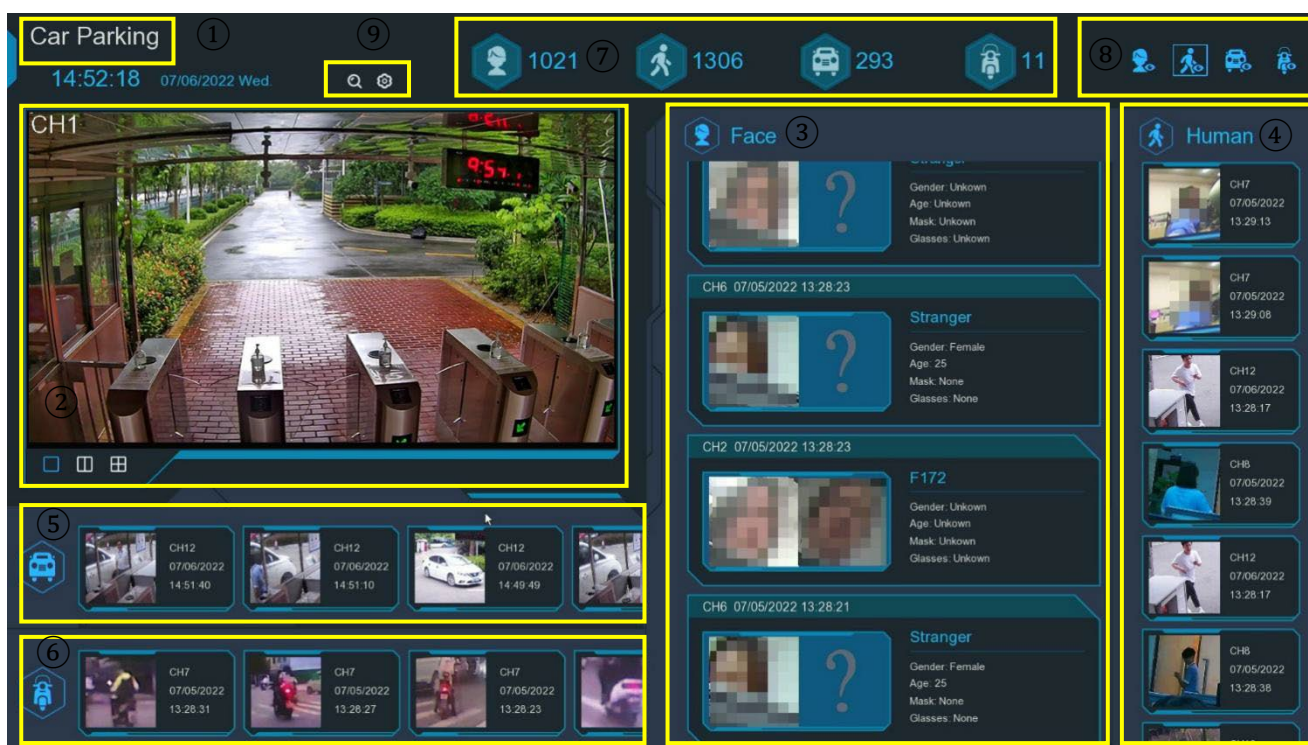



- **Enable:** Check this box to enable sending attendance statistics by email.
 - **Send Email:** Set the preset time for sending the email.
 - **Mode:** Choose to send the email once every Day, Week, or Month:
 - **Day:** Send the previous day's attendance data once daily.
 - **Week:** Send the last 7 days' attendance data once weekly.
 - **Month:** Send the previous month's attendance data once monthly.
 - **Working Days:** Select the working days. This will affect the attendance statistics.
8. Click the setting  to configure your email settings. See section [5.5.3.1 Email Configuration](#) for more details.

6.3 Object Classification

The Object Classification leverages AI capabilities like face detection, human detection, and vehicle detection to intelligently classify and count the number of detected faces, human beings, motor vehicles, and non-motor vehicles over a certain period, being an important feature in intelligent video analytics systems typically applied in scenarios with concentrated people and vehicle traffic requiring security monitoring, such as commercial complexes, transportation hubs, tourist attractions, construction sites, and parking lots.



1. Customized title for the object classification view
2. Live view screen: Displays the live camera feeds. Click the screen split buttons  to change the layout. Click a button repeatedly to cycle through layout options.
3. Notifications of detected face images. Use the mouse wheel to scroll up and down.
4. Notifications of detected human images. Use the mouse wheel to scroll up and down.
5. Notifications of detected motor vehicles. Use the mouse wheel to scroll left and right.
6. Notifications of detected non-motor vehicles. Use the mouse wheel to scroll left and right.
7. Statistical data of detected objects in the selected time period.
8. Click the icons to display or hide respective object types:
 -   To display or hide face images.
 -   To display or hide human images.
 -   To display or hide motor vehicle images.
 -   To display or hide non-motor vehicle images.

9. Click the search icon  to search recordings of human & vehicle detection events.
10. Click the setting icon  to configure the object classification settings:

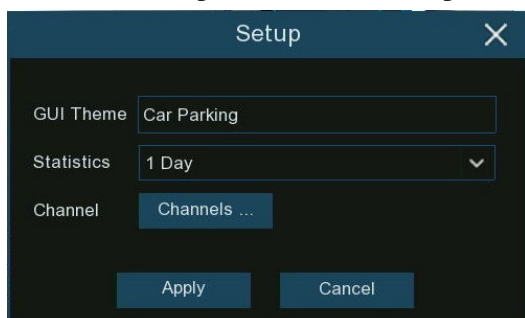

GUI Theme: Customize the title for the object classification view.

Statistics: Select the time period for which to show the data.

Channels: Click to choose the channel(s) for which to show the data

Chapter 7 Search, Playback & Backup

The Search function allows you to search for and play back previously recorded videos and snapshots that are stored on the NVR's hard drive(s). You have the option to play video recordings that match your scheduled recordings, manual recordings, or triggered by alarm events. The Backup function enables you to save important events (both video recordings and snapshot images) to a USB flash drive for archiving or reviewing purposes.













7.1 Search & Play in General



On this page, you can search for and play back the entire recorded video footage for a particular day.



1. **Search Options:** The system provides various search & playback methods: General, Events, Sub-periods, Smart, Tag, External File, Picture, Slice & AI. Click the respective tab to search for different types of event recordings.
2. **Search Date:** Click the calendar icon to select the date to search for. A red underline on a date indicates recorded footage is available on those dates.
3. **Search Type:** This is the event type you can search for. Leave all event types enabled to search for all, or select specific types to narrow your search.
4. **Stream Type:** Select the video stream to search for. Mainstream is the default option. Substream can be selected if dual-stream recording is enabled.
5. **Channel Selection:** Choose the channel(s) you want to search & play.
6. **Play Control Buttons:** Use the play control buttons to control video playback:



Button	Function
	Enlarge the video playback to full screen
	Rewind, subsequent clicks change the rewind speed
	Slow play, subsequent clicks change the playback speed
	Play at normal speed
	Pause
	Play frame-by-frame, click once to advance a single frame
	Stop playback
	Fast forward, subsequent clicks change the speed
	Digital zoom - click this then use mouse scroll wheel to zoom in/out. Use the picture-in-picture to select viewing area. Right-click to exit.
	Edit video by setting start/end mark points to copy to USB drive. See 7.1.1 Video Clip Backup .
	Adjust audio output volume
	Take a snapshot and save to USB drive

	Tag to record info about a person/object in the video. Select camera, pause on the subject, click this button. Tagging enables you to create a searchable, descriptive index of important events or points of interest within extensive video recordings.
	Same as above but allows naming the tag
	Switch between original aspect ratio or stretch for all cameras

7. **Timeline:** Quickly locate the playback position by clicking the timeline. Zoom in/out using the timeframe options for precise positioning.



8. Indicates the video type on the timeline.



9. **Playback Status:** Displays the current playback status.

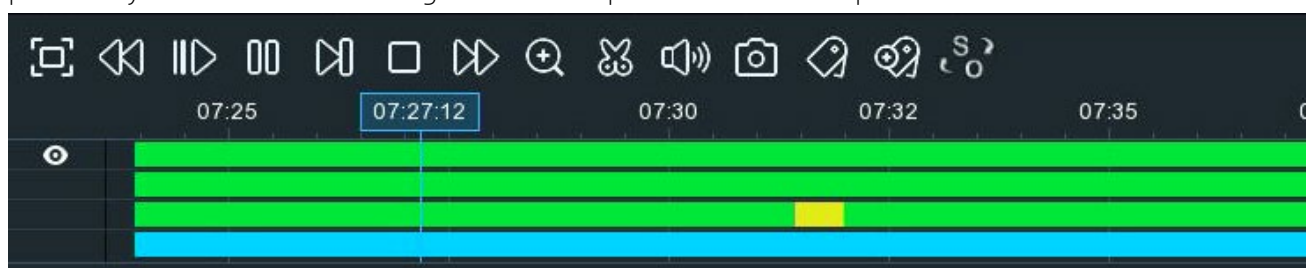

7.1.1 Video Clip Backup

During playback, the Video Clip Backup feature allows users to precisely clip desired portions from previously recorded video footage and back up these selected clips onto USB drives.

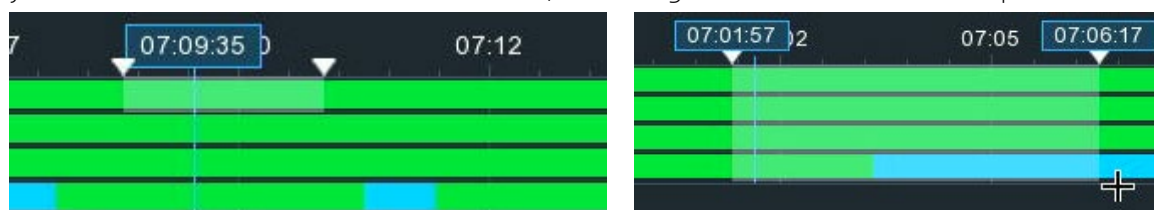

1. Insert your USB flash drive into the NVR
2. Search and start playback of a recorded video.
3. Move your mouse cursor and click on the timeline where you want to select a portion of the video.
4. Click  button. You will see two white triangles on the timeline. Move them left or right to select the start and end points of the video section you want to backup. If you want to select multiple channels, you can click on the timeline position for the start time, then hold and drag your mouse to select additional channels, releasing at the desired end time position.



5. The  icon is now changed to  icon now, click it to initiate saving the selected video clip(s). Select the video format you want to save, if you choose the RF format, you can also encrypt the

file you want to save. When you use the dedicated player to play the saved file, you need to enter the password to play it. After setting is complete, click “Save” to save the file to the USB drive.

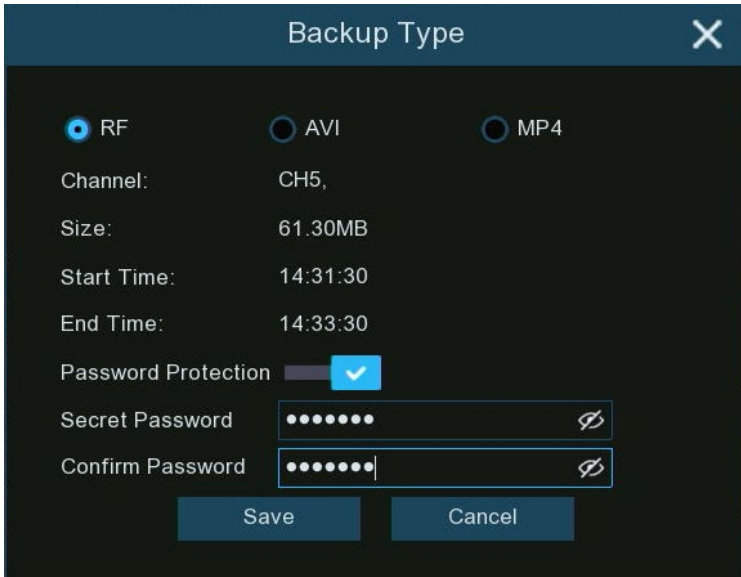

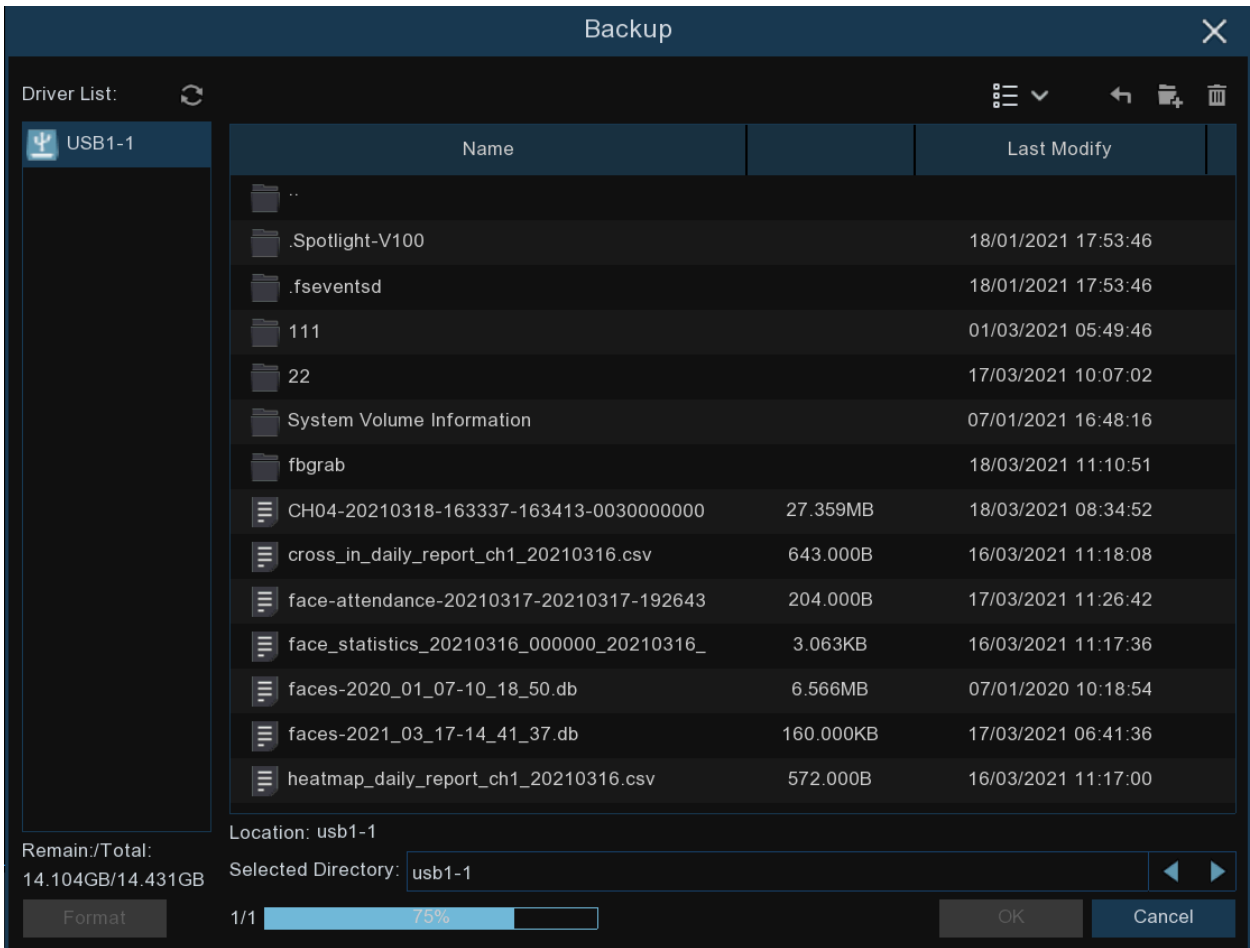

- Choose the directory on your USB flash drive where you want to save the video clip(s), then click OK. The progress bar at the bottom of the window shows the backup progress.







7.2 Search, Play and Back Up Event Recordings



The primary function of the Event Search feature is to locate and retrieve recordings generated by alarm events or normal recordings that occurred within a specified time period. By defining the alarm event, time, and channel, you can quickly search for and review the alarm events you need to see.

The screenshot shows the 'Events' tab selected. The search sidebar on the left has the following settings: Date from 06/03/2024 00:00:00 to 06/18/2024 23:59:59; Search Type: Normal, Normal Events (All), and Cross Counting; Stream Type: Mainstream; Channel: CH1; and Information: Channel: CH1, Time: 17:54:43-18:04:13, Type: C, Size: 253.56MB. The main event list shows 120 events, with event 118 selected. The bottom control bar shows 'Descending Order', 'Select current page', 'Select all pages', navigation arrows, and 'View' options (Thumbnail, List, Detail).

1. Click the **Events** tab.
2. Select the start date & time, and end date & time for your search.
3. Select the event type that you can search for. Leave all event types enabled to search for all, or select specific types to narrow your search.
4. Select the video stream to search: Mainstream (default) or Substream (if dual-stream recording is enabled).
5. Select the camera(s) you would like to search on.
6. Click Search button to commence a search.
7. The result window will display thumbnails of each event that matches your search criteria. Use the arrow buttons on the bottom to navigate through pages or use the keypad to jump to a specific page.
8. Click these buttons to change how the events are displayed: Thumbnail (default), List, or Detail view. In the Detail view, you can lock/unlock events to prevent them from being overwritten by clicking the  or  icons.

<input checked="" type="checkbox"/>	11	CH11	SMN	07/07/2022	07:54:02	07:54:32	7.93MB		
<input checked="" type="checkbox"/>	12	CH11	MN	07/07/2022	07:54:28	07:55:04	9.52MB		
<input checked="" type="checkbox"/>	13	CH11	SMN	07/07/2022	07:54:58	07:55:36	10.00MB		

9. Tick the checkbox to display events in descending order.

10. Click on an event thumbnail to display additional information on the left.
11. Tick the checkbox above each thumbnail to select it. You can tick the "Select current page" checkbox to select all events on the current page, or tick the "Select all page" checkbox to select all events on all pages.
12. The number and total size of selected event(s) will be displayed here.
13. Click backup button  to save all selected events to your USB flash drive directly. Or you can click play button  to enter the playback window. See more on [7.2.1 Event Playback Control](#).

7.2.1 Event Playback Control

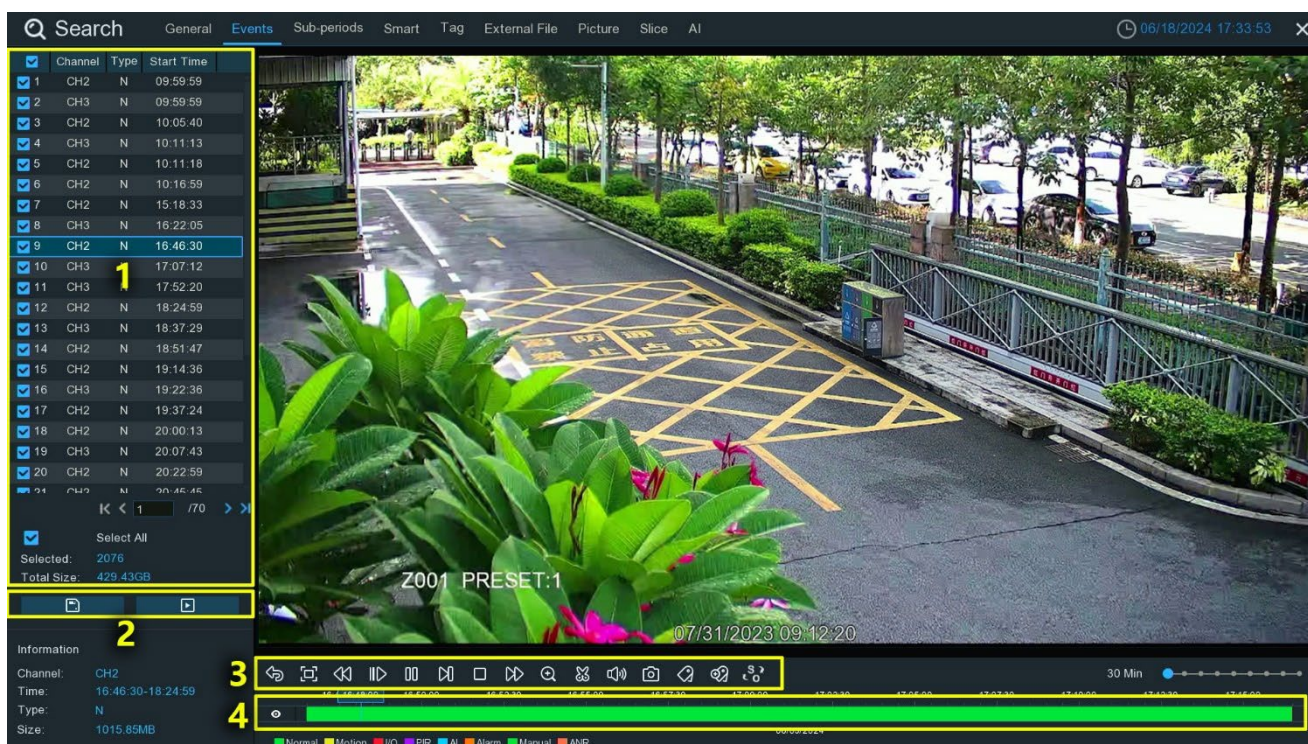



Channel	Type	Start Time	
1	CH2	N	09:59:59
2	CH3	N	09:59:59
3	CH2	N	10:05:40
4	CH3	N	10:11:13
5	CH2	N	10:11:18
6	CH2	N	10:16:59
7	CH2	N	15:18:33
8	CH3	N	16:22:05
9	CH2	N	16:46:30
10	CH3	N	17:07:12
11	CH3	N	17:52:20
12	CH2	N	18:24:59
13	CH3	N	18:37:29
14	CH2	N	18:51:47
15	CH2	N	19:14:36
16	CH3	N	19:22:36
17	CH2	N	19:37:24
18	CH2	N	20:00:13
19	CH3	N	20:07:43
20	CH2	N	20:22:59
21	CH3	N	20:26:46

















Selected: 2076
Total Size: 429.43GB

Information
Channel: CH2
Time: 16:46:30-18:24:59
Type: N
Size: 1015.85MB

Play Control Buttons: 

1. Event List - Browse and select events here. Use the arrow buttons to navigate between pages or enter a specific page number using the keypad. Double-click an event to play it.
2. In the Event List, you can select the events you want to backup or replay. Click  button to save the selected events to your USB flash drive. Click  button to play the selected events.
3. **Play Control Buttons:** Use the play control buttons to control video playback:



Button	Function
	Return to the Event search page
	Enlarge the video playback to full screen
	Rewind, subsequent clicks change the rewind speed
	Slow play, subsequent clicks change the playback speed
	Play at normal speed
	Pause
	Play frame-by-frame, click once to advance a single frame
	Stop playback
	Fast forward, subsequent clicks change the speed
	Digital zoom - click this then use mouse scroll wheel to zoom in/out. Use the picture-in-picture to select viewing area. Right-click to exit.
	Edit video by setting start/end mark points to copy to USB drive. See 7.1.1 Video Clip Backup .
	Adjust audio output volume
	Take a snapshot and save to USB drive
	Tag to record info about a person/object in the video. Select camera, pause on the subject, click this button. Tagging enables you to create a searchable, descriptive index of important events or points of interest within extensive video recordings.
	Same as above but allows naming the tag
	Switch between original aspect ratio or stretch for all cameras

4. **Timeline:** Quickly locate the playback position by clicking the timeline. Zoom in/out using the timeframe options for precise positioning.

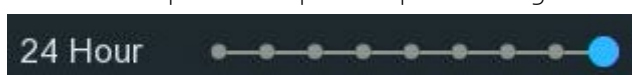

7.3 Sub-periods Playback

The Sub-periods Playback function allows you to simultaneously play multiple video segments from different time periods on a single channel. The recordings from the selected time range are evenly divided and displayed across split-screen panes according to the selected split-screen mode.















For example, if you have a 1-hour video recording and select a 4-pane split-screen mode, the video will be divided into 4 segments of 15 minutes each. Each 15-minute segment will play individually in its own split-screen pane.

The key purpose of this feature is to enable efficient reviewing of footage from a single channel across different time periods simultaneously, without having to switch between multiple videos. It provides a convenient way to analyze and compare activities or events that occurred during different times of the day.



1. Click the **Sub-periods** tab.
2. Choose the date & time you want to search. It determines the time length of the recording you want to search and play.
3. Select a number on the Split-screens, it indicates the number that how many video segments you want the recordings to be divided evenly and played in each screen.
4. Check the recording types you want to search, or tick the checkbox of "**Search Type**" to select all.
5. Select the video stream to search for. Mainstream is the default option. Substream can be selected if dual-stream recording is enabled.
6. Choose the channel you want to search. It supports to search & play one channel only at a time.
7. Click the play button **▶** to start playing.



Button	Function
	Enlarge the video playback to full screen
	Rewind, subsequent clicks change the rewind speed
	Slow play, subsequent clicks change the playback speed
	Play at normal speed
	Pause
	Play frame-by-frame, click once to advance a single frame
	Stop playback
	Fast forward, subsequent clicks change the speed
	Digital zoom - click this then use mouse scroll wheel to zoom in/out. Use the picture-in-picture to select viewing area. Right-click to exit.
	Edit video by setting start/end mark points to copy to USB drive. See 7.1.1 Video Clip Backup .
	Adjust audio output volume
	Take a snapshot and save to USB drive
	Tag to record info about a person/object in the video. Select camera, pause on the subject, click this button. Tagging enables you to create a searchable, descriptive index of important events or points of interest within extensive video recordings.
	Same as above but allows naming the tag
	Switch between original aspect ratio or stretch for all cameras

- Click on any one of the split-screens, the time period of the video split-screen will be displayed on the timeline. The color bar on the top of the timeline indicates the time span of the video split-screen you have clicked. The color bar on the bottom of the timeline indicates the time span for the whole recordings you have searched.

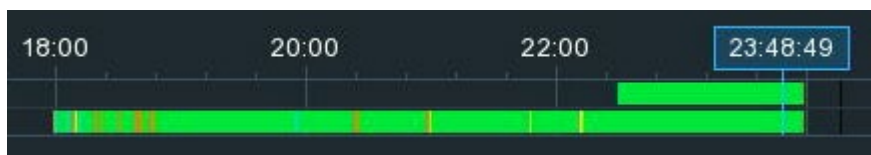

7.4 Smart Search & Playback





With the Smart Search function, you will be able to quickly search for and play back motion event recordings from a supported camera, regardless of whether motion detection is enabled or not on that particular camera. What's more, it allows you to define one or more specific regions of interest (ROIs) within the video frame, making it easier to pinpoint and focus the search on the exact areas you are interested in.











1. Click the **Smart** tab.
2. Choose the date & time you want to search. It determines the time length of the recording you want to search and play.
3. Check the recording types you want to search
4. Choose the channel you want to search. It supports to search & play one channel only at a time.
5. On the time slot, two progress bars will be displayed. The green portion represents all the recordings found within your set search range, while the blue portion indicates the parts where motion occurred.



6. Click the play button  to start playing.





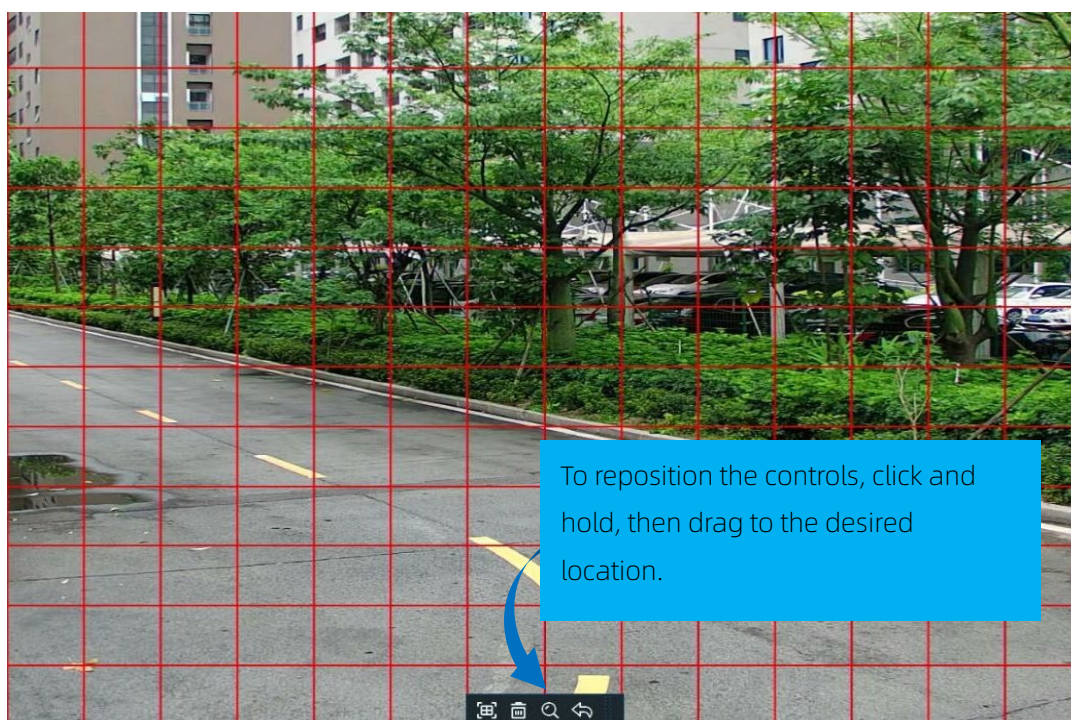

Button	Function
	Enlarge the video playback to full screen
	Rewind, subsequent clicks change the rewind speed
	Slow play, subsequent clicks change the playback speed
	Play at normal speed
	Pause

	Play frame-by-frame, click once to advance a single frame
	Stop playback
	Fast forward, subsequent clicks change the speed
	Digital zoom - click this then use mouse scroll wheel to zoom in/out. Use the picture-in-picture to select viewing area. Right-click to exit.
	Edit video by setting start/end mark points to copy to USB drive. See 7.1.1 Video Clip Backup .
	Adjust audio output volume
	Take a snapshot and save to USB drive
	Smart Search button.
	Tag to record info about a person/object in the video. Select camera, pause on the subject, click this button. Tagging enables you to create a searchable, descriptive index of important events or points of interest within extensive video recordings.
	Same as above but allows naming the tag
	Switch between original aspect ratio or stretch for all cameras

7. It supports to narrow the search by define one or more specific areas of the video. Click the  button on the Play Control Buttons, the camera will be shown full screen, and the Smart mode controls will be visible.



-  Select a full-screen detection area.
-  Delete all areas created.
-  Search and play video based on the areas defined.
-  Return to the playback interface.

To define one or more specific areas, please do the following:

Click  button to delete all area, and then drag to select the area that you want to define.

Multiple areas can be defined.



When finished, click the Search button  to search recordings based on the areas defined.

You'll be returned back to the playback interface. Segments matching your search criteria will be shown on the timeline in dark blue color.

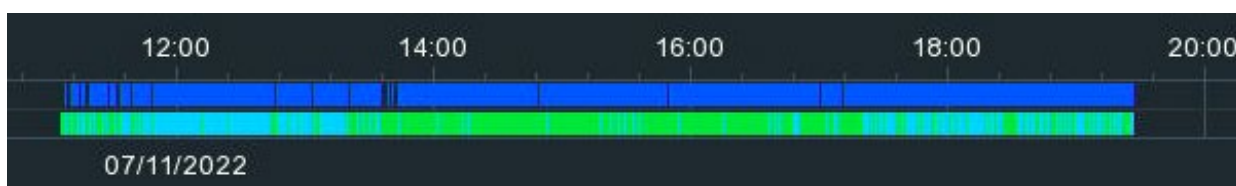

7.5 Tag Search & Playback

The Tag Search & Playback function allows you to search, play, and manage recorded video footage based on descriptive tags or labels that you have added during live monitoring or playback sessions. By assigning relevant tags to specific events or activities as they occur, you can easily locate and review those tagged segments later on.

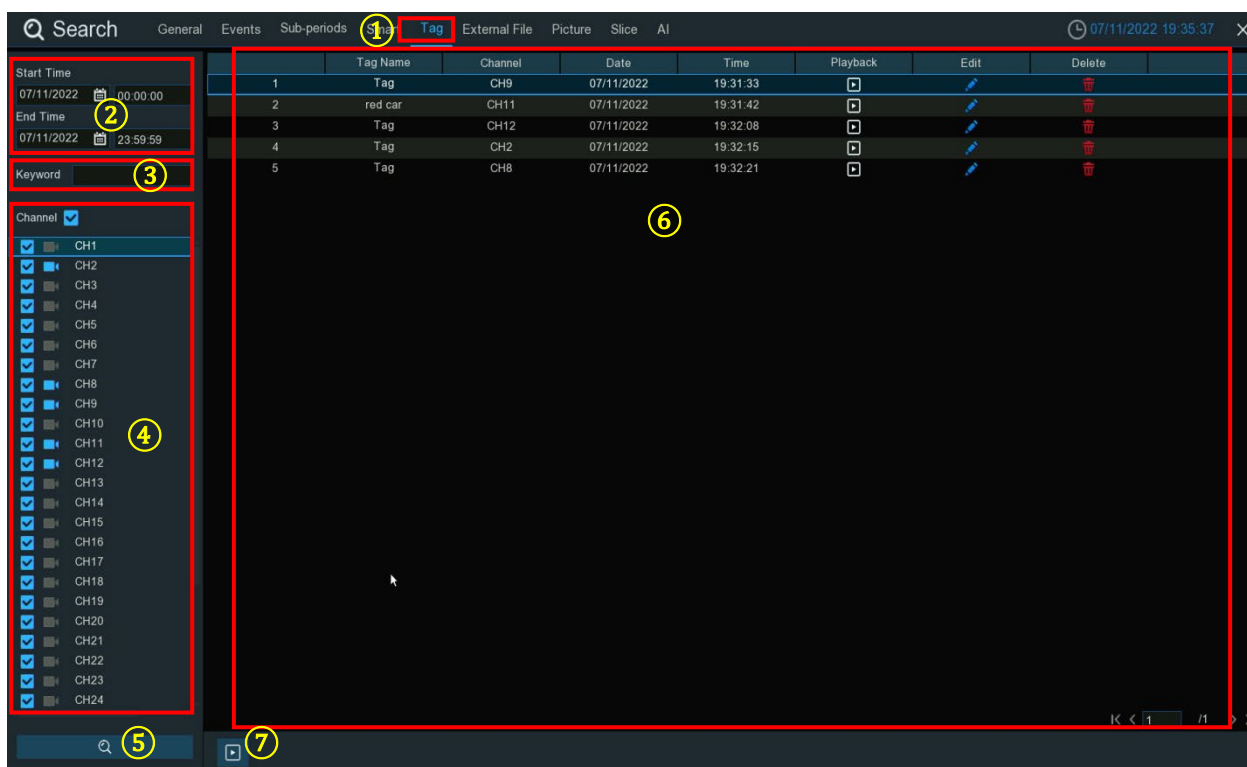

1. Click the **Tag** tab.
2. Select the start day & time and end day & time you want to search for.
3. If you have created one or more customized tags, click this to input the tag name (tag names are case sensitive).
4. Select the channel(s) you want to search on.
5. Click the search button to initiate the search.
6. Tags matching your specified search criteria will be displayed in the right window.
7. Click the play button to start playing.

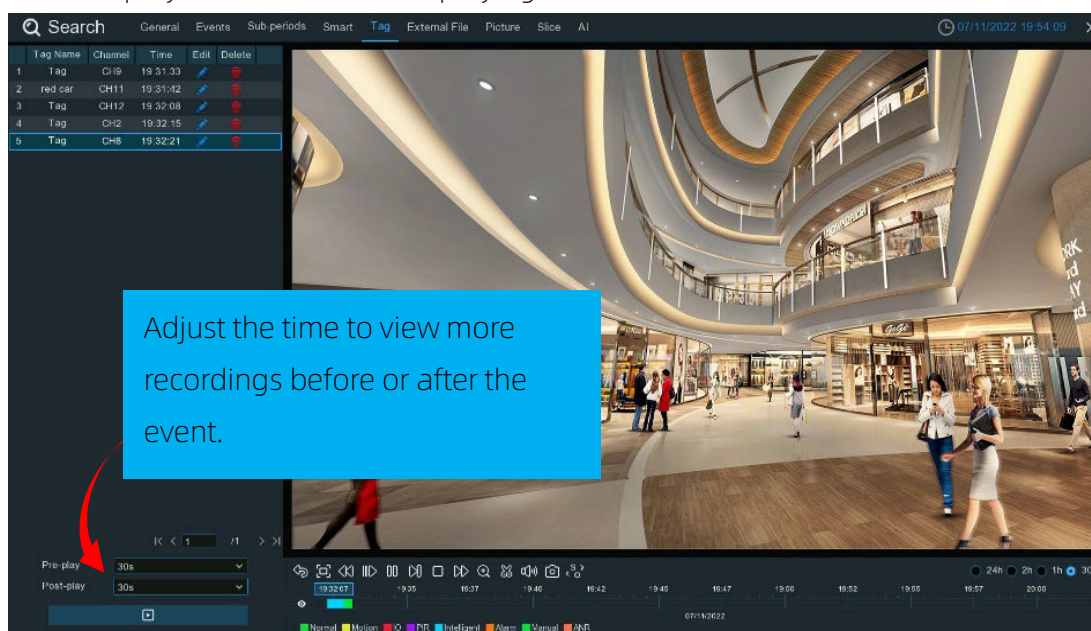







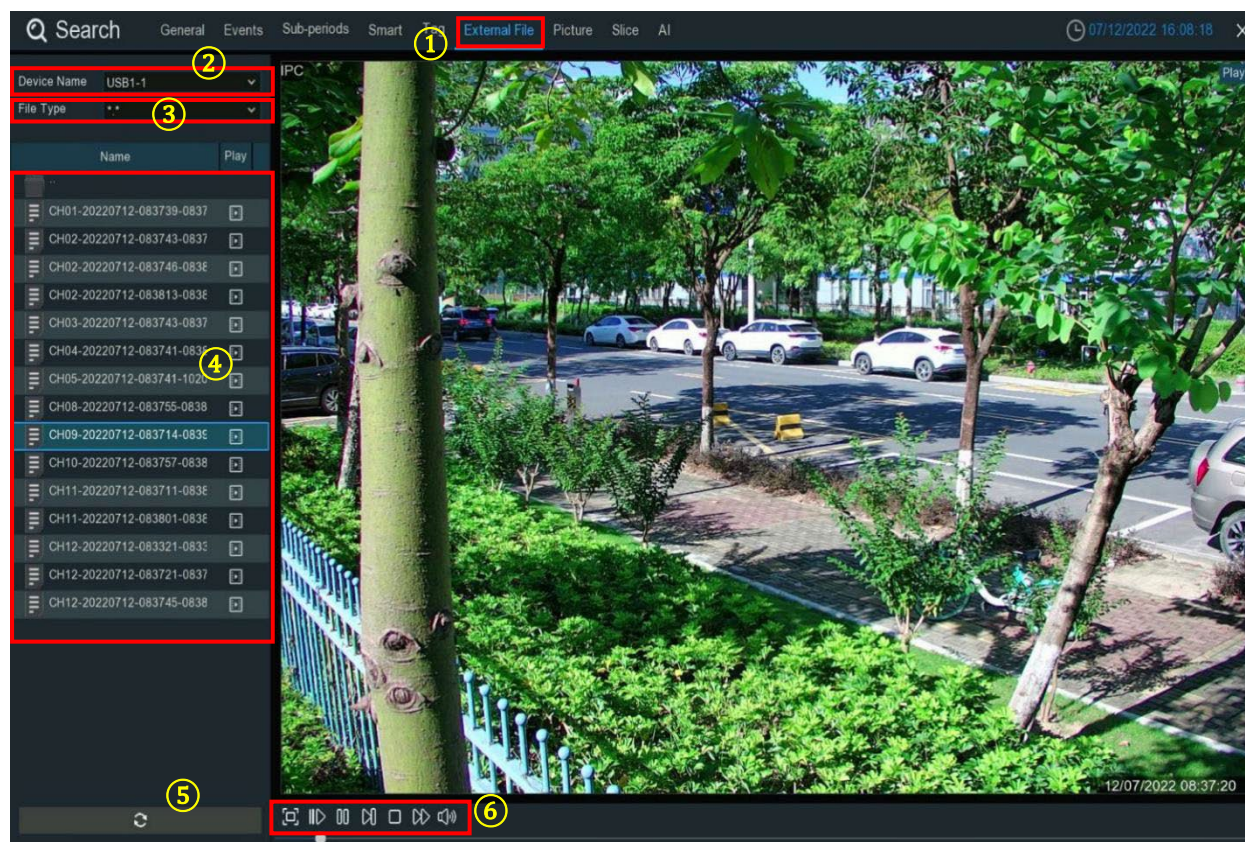

8. If you want to modify the tag name, click button. Click button to remove the tag.

7.6 Play External File

The NVR supports playing back videos that you have copied to a USB flash drive.



1. Click the “External File” tab.
2. If multiple USB flash drives are connected, click the drop-down menu to select the drive you want to access.
3. Select the file type you want to search and play. Leave default to search all supported formats.
4. Navigate to and select the directory folder where the video files are stored. Double-click on an event to initiate playback.
5. Click this refresh button if you want to reload the file list from the USB flash drive
6. Use the play control buttons to control video playback:



Button	Function
	Enlarge the video playback to full screen
	Slow play, subsequent clicks change the playback speed
	Play at normal speed
	Pause
	Play frame-by-frame, click once to advance a single frame
	Stop playback
	Fast forward, subsequent clicks change the speed
	Adjust audio output volume

7.7 Search & View Snapshots

The Search & View Snapshots function allows you to search through, view, and export captured snapshot images from the NVR to a USB flash drive.



1. Click the **Picture** tab.
2. Click the calendar icon to select a date to search for. A date with a red underline indicates that snapshots were captured on those particular dates. For the time range, you can search over the full 24 hours or use the keypad to enter a specific start and end time.
3. **Search Type:** This allows you to specify the event type(s) you want to search for. You can leave all event types enabled to search for all types, or select specific event types to narrow your search.
4. Select one or more cameras that you would like to include in the search. Cameras that match your search criteria will be highlighted in blue.
5. Click search button to commence the search.
6. Thumbnails of snapshots that match your search criteria will be displayed in the result window. Use the arrow buttons to navigate through pages or enter a specific page number using the keypad.
7. Click these buttons to change how the search results are displayed. The default view is Thumbnail, but you can switch to List or Detail view.
8. Check this box to view the snapshots in descending order (newest first).



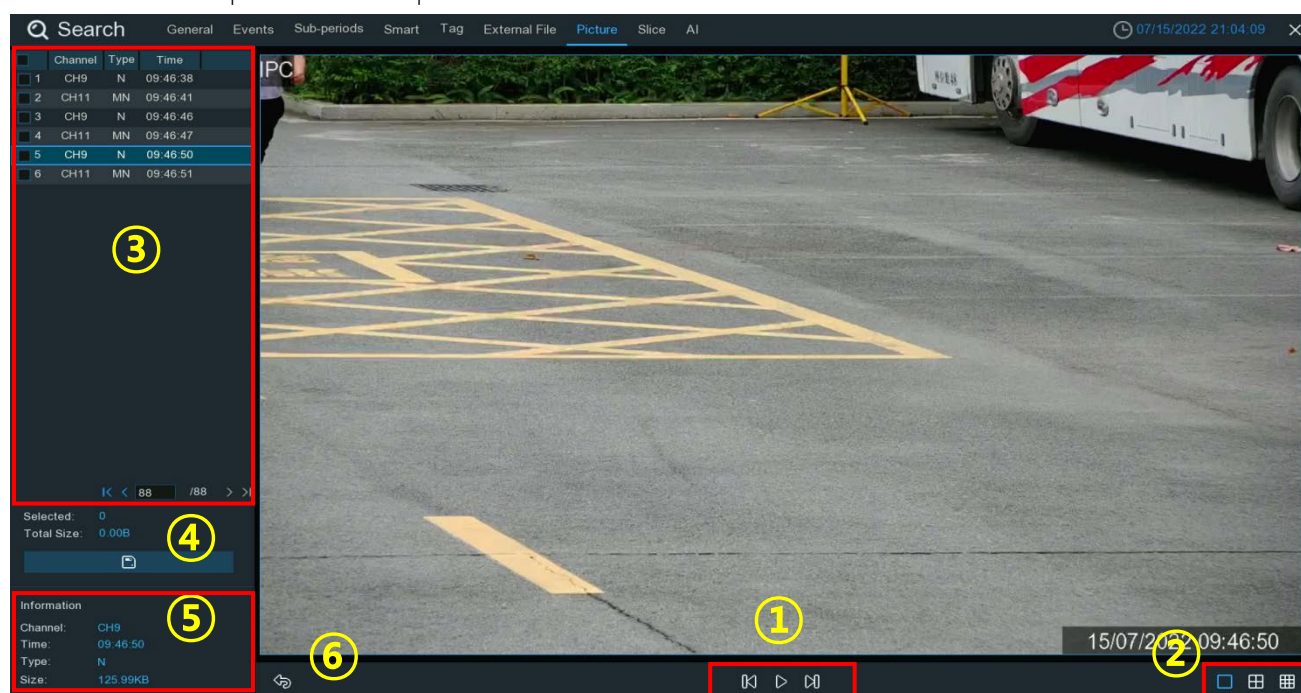

9. Click on a thumbnail to display relative information about that snapshot in the bottom-left corner.
10. Check the box above each event thumbnail to select it, or check the "Select" box to select all events on the current page.
11. The number and total size of selected event(s) will be shown here.
12. Click the backup button  to copy all selected snapshots directly to your USB flash drive. Alternatively, you can click the play button  to enter the slideshow mode. See section 7.7.1 for more details on Playing Slideshow.

7.7.1 Playing Slideshow

The selected snapshots will be presented in a slideshow.



1. Play control buttons:

Button	Function
	When the slideshow is paused, click this to view the previous snapshot.
	Click to play the slideshow.
	Click to pause the slideshow
	When the slideshow is paused, click this to view the next snapshot.

2. Adjust this setting to specify how many snapshots you want to view simultaneously on the screen.
3. The selected snapshots will be displayed in this area. Use the arrow buttons to navigate through pages or enter a specific page number using the keypad

4. Select one or more snapshots, then click this button to copy them to a USB flash drive.
5. Click this to display detailed information about the selected snapshot.
6. Click this button to go back to the previous screen.

7.8 Slice Search

This function is able to slice recordings into one-minute segments, which helps to quickly locate and review specific moments of interest.

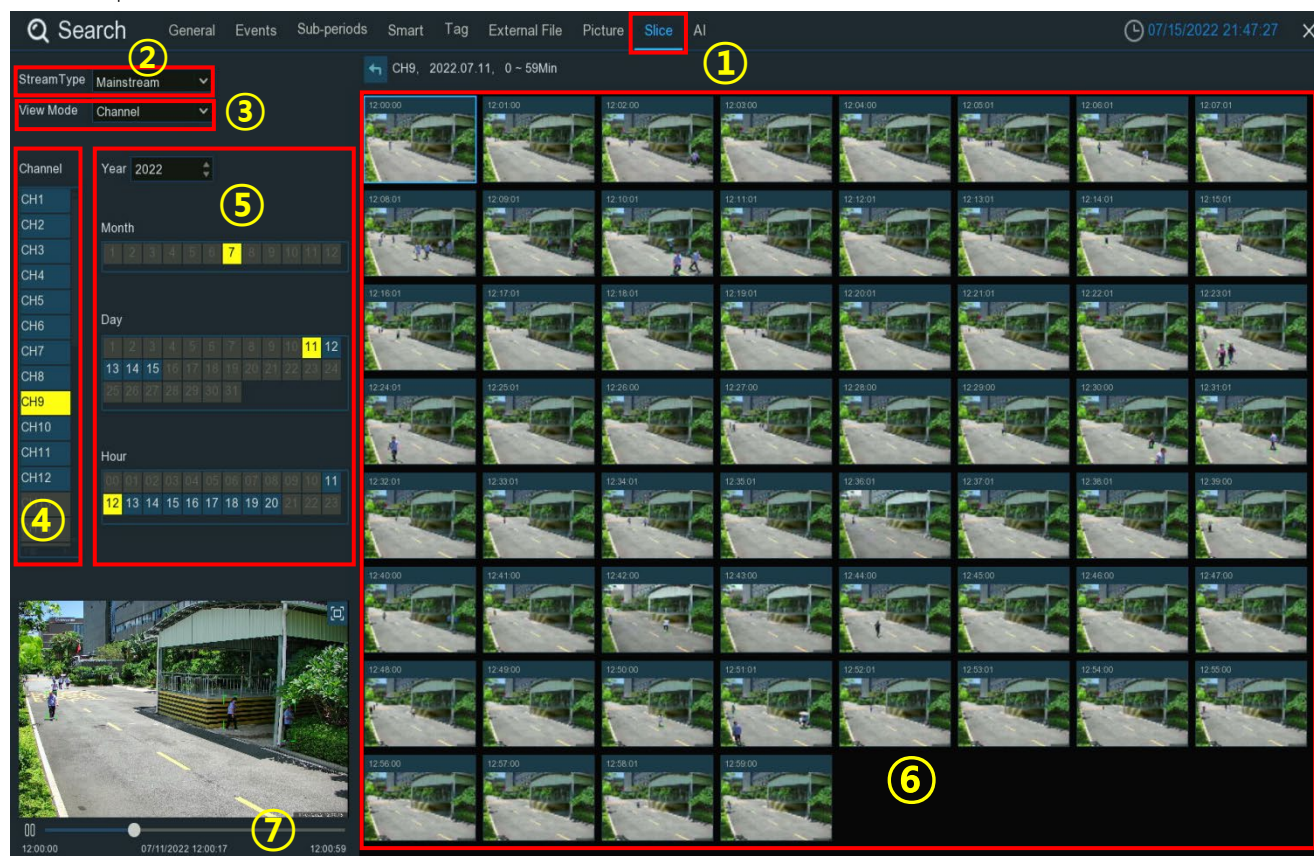

1. Click the **Slice** tab.
2. Select the video stream you want to search: Mainstream is the default option. Substream can be selected if dual-stream recording is enabled.
3. Select the View Mode:
 - **Channel:** Allows you to first prioritize and select a specific camera channel of interest. Once selected, you can rapidly switch between different time periods to display snapshot thumbnails for each minute within the hourly timeframes you choose to examine for that particular camera. This enables an efficient minute-by-minute visualization and analysis of activities captured by the focused camera channel across various time intervals.
 - **Time:** Allows you to first select a specific hour time range, and then browse through different camera channels to examine snapshot thumbnails for each minute within that hourly period across multiple channels. This enables you to get a granular, minute-by-minute overview of

activities captured by various cameras during the selected hour, facilitating a comprehensive analysis across different monitored areas.

4. Choose the specific channel you want to search. Only one channel can be searched at a time.
5. Select the time you want to search in the order of first specifying the year, then month, date, and lastly the hour.
6. Once the channel and hour have been selected, the available one-hour recording will be sliced into 60 one-minute segments, and thumbnail images for each minute will be displayed on the screen.
7. Click on any thumbnail image, and the video for that minute will be played in the bottom-left corner. Click on the timeline to adjust the playback position. Click the full-screen button  to view the playback in full-screen mode and access backup options.

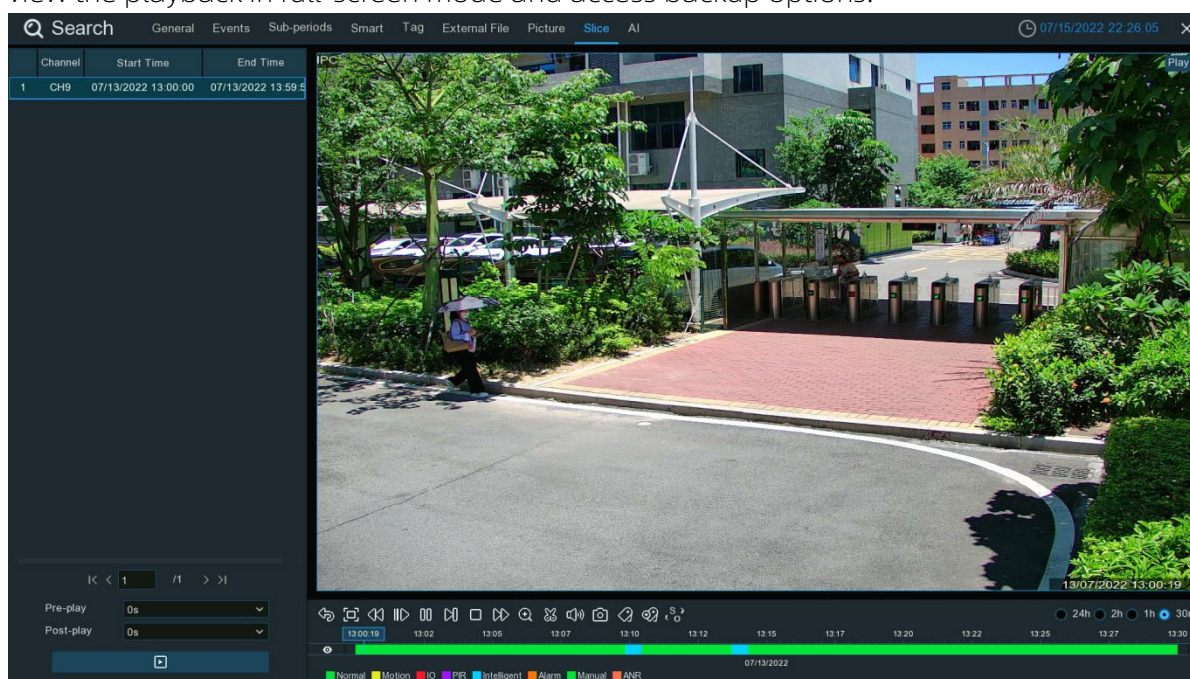

7.9 AI Search



In this search section, you can search for common AI detection triggered events and recordings.

7.9.1 Face Detection

You can search for face images captured by Face Detection, and you can also import target face avatar(s). The system will then compare all the captured face images and retrieve those that meet the similarity threshold with the target avatar(s).

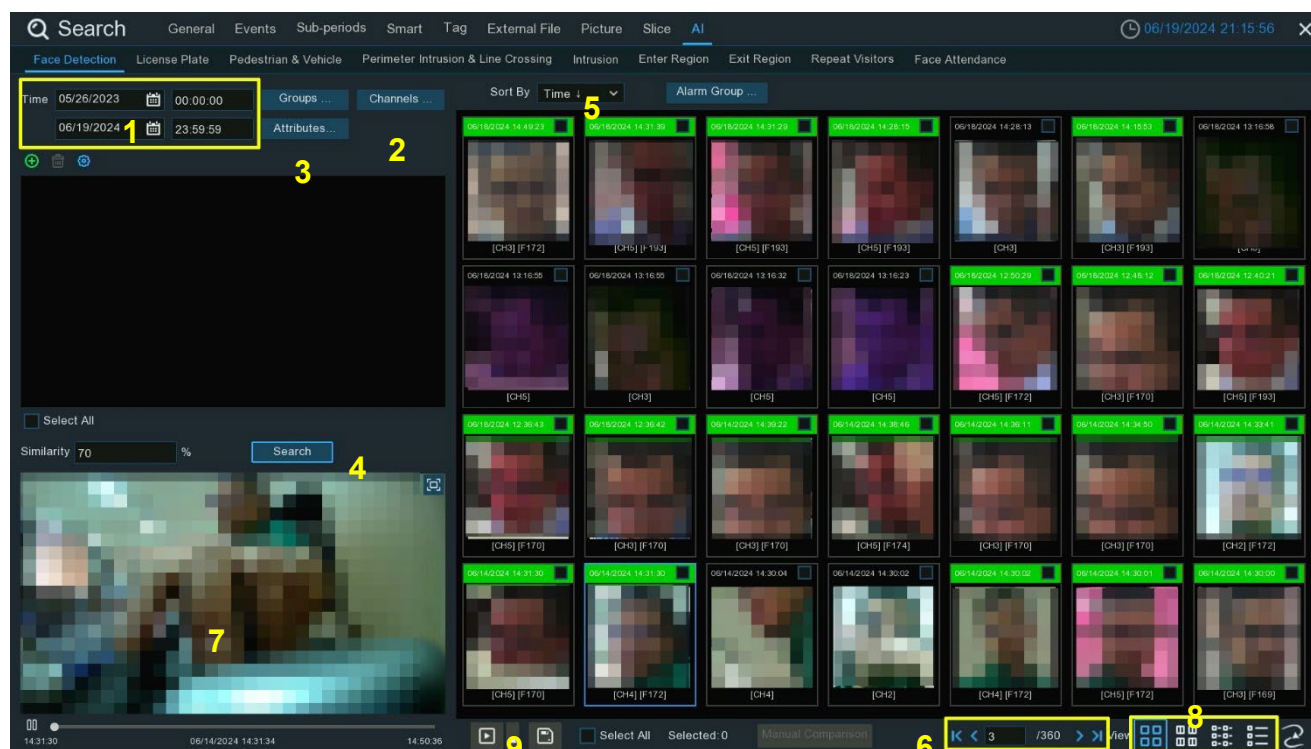
7.9.1.1 Search for Captured Images of Human Faces



1. Select the start date, time and end date, time you want to search for.
2. Select the channels you need to search, by default all channels are selected, or you can select specific channel(s) to search.
3. You can check the face attributes you want to search for in the “Attributes” button (limited by product performance, the recognized facial features may not be completely accurate).
4. Click the “Search” button. All photos captured within the set time and channels will be displayed in the window on the right.
5. You can click the drop-down box next to “Sort By” to sort by time.
6. You can use the arrows in the bottom right corner to turn pages, or directly enter the page number you want to jump to in the input box.
7. Use the left mouse button to click on any picture, if recording was triggered during capture, you can see the recording file at that time in the bottom right corner.
8. You can choose different viewing methods to view the search results:
 - **Thumbnail 1:** Display the searched pictures as thumbnails
 - **Thumbnail 2:** The searched results will be compared with the face profiles saved in the face database.
 - **List:** View the search results in a list.
 - **Details:** Display the details of the search results.
9. After selecting the files, you can directly click the play button  to play the recording file captured at that time. You can also click the triangle icon  next to it to select the delay time

for playing the video, with the following options: 5s, 10s, 20s, 30s, 1min, 2min, 5min, 10min and Custom Playback.

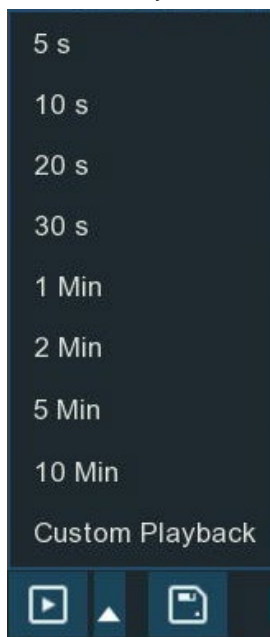

In Custom Playback, you can set how long to extend the playback time before and after the capture.

10. You can also click the save button  to make a backup. You can choose to save picture files and/or video files. When selecting video files, you can pick the file format for saving. If you choose the RF format, you have the option to encrypt the saved files. Encrypted files require using a dedicated player and entering a password to view them.

You can also define the length of the video clips to save by setting the Pre-event Time and Post-event Time. These settings determine how much recording time is included before and after the detected event itself.

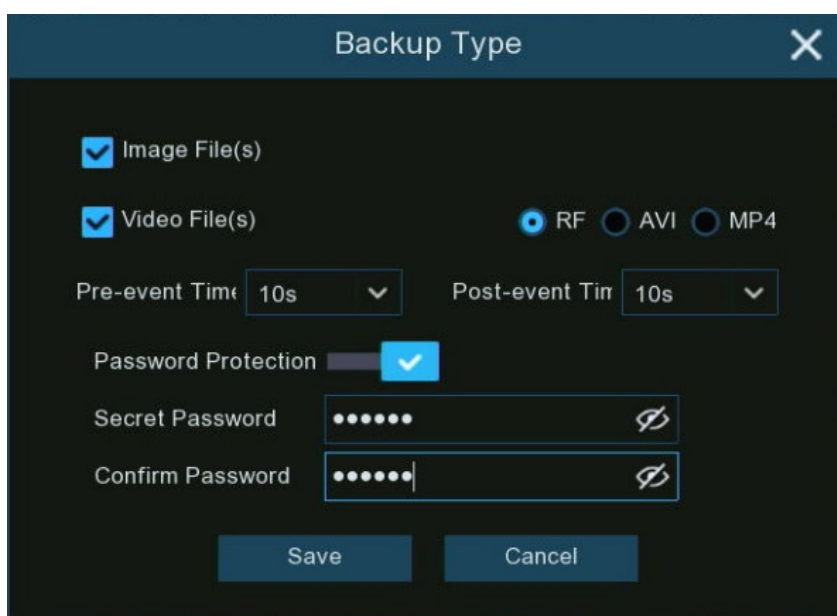

7.9.1.2 Match Search for Facial Images

In addition to searching for all captured facial images over the entire time period, you can also perform precise matching searches.

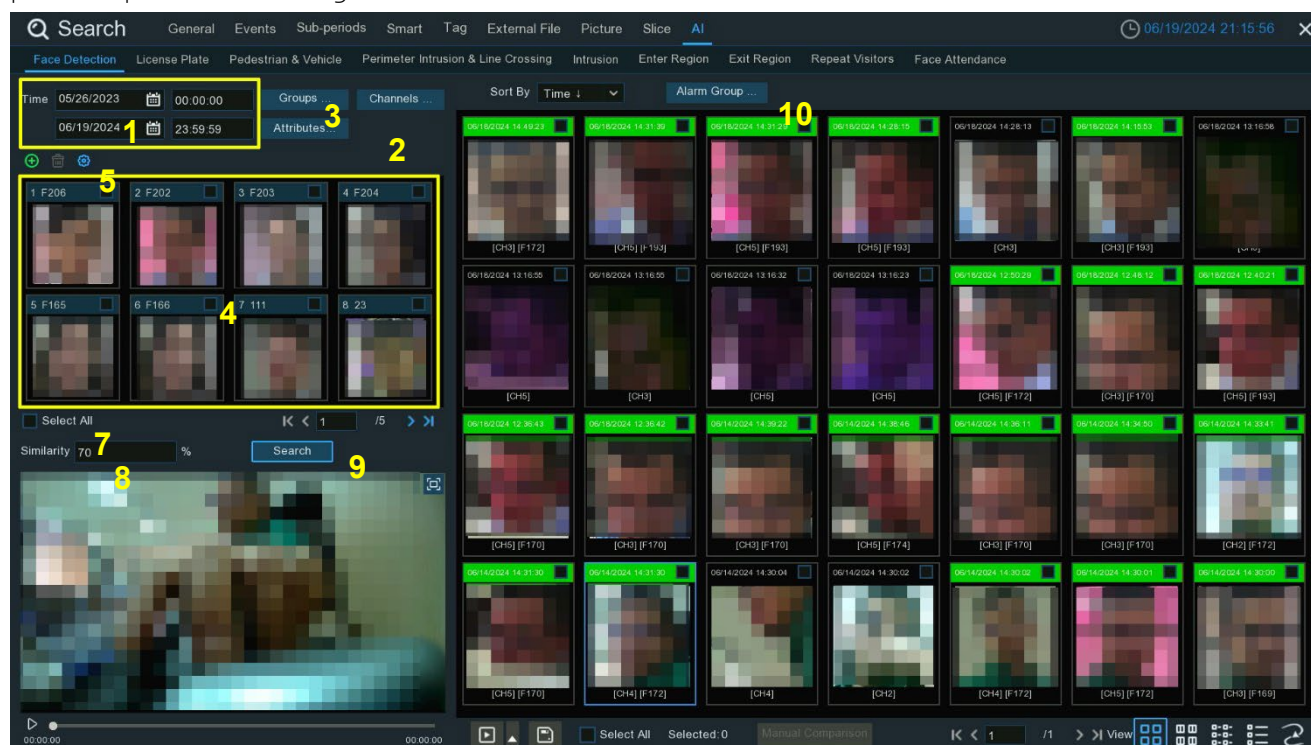

1. Select the start date, time and end date, time you want to search for.
2. Select the channels you need to search, by default all channels are selected, or you can select specific channel(s) to search.
3. Click **“Groups”** , and select the target face group(s) you need to search for inside.
4. All face images in the selected face group(s) will be displayed in the target avatar window.
5. You can also click the add button **+** above to individually select individual target avatar(s) from the face database, captured faces, or a USB drive, following the on-screen prompts.

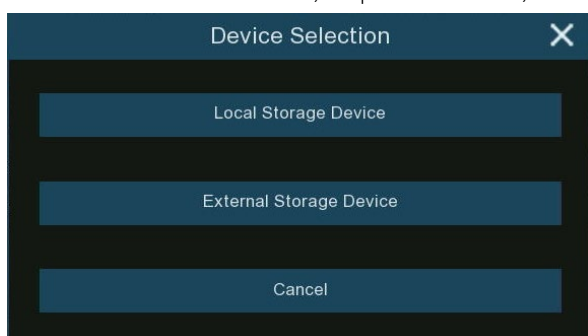

6. In the target avatar window, click on an avatar to select or deselect it. You can use the delete button to remove selected avatar(s), reducing the target faces.
7. After setting the target avatar(s) you want to keep, click **“Select All”** to select them all.

8. In the **"Similarity"** setting, set the percentage threshold for how closely a detected face must match the target faces. The default is 70%. A higher similarity percentage will result in fewer matching results.
9. Click **"Search"** to start the matching search. The results will be displayed in the window on the right.
10. You can further filter the search results by selecting **"Alarm Groups"**. After selecting one or more groups, the search results will be automatically filtered to only show faces from the checked groups.
11. For the search results, you can perform operations such as playback, backup, etc. For specifics, please refer to the relevant descriptions in [7.9.1.1 Search for Captured Images of Human Faces](#).

7.9.1.3 Tracking Face

You can load a map and position your cameras on it. With the tracking function, you can easily see someone's appearance/disappearance time & location across your designated cameras, as well as their movement path during the selected time period.

1. On the face search page, click the tracking button  to enter the tracking operation page.

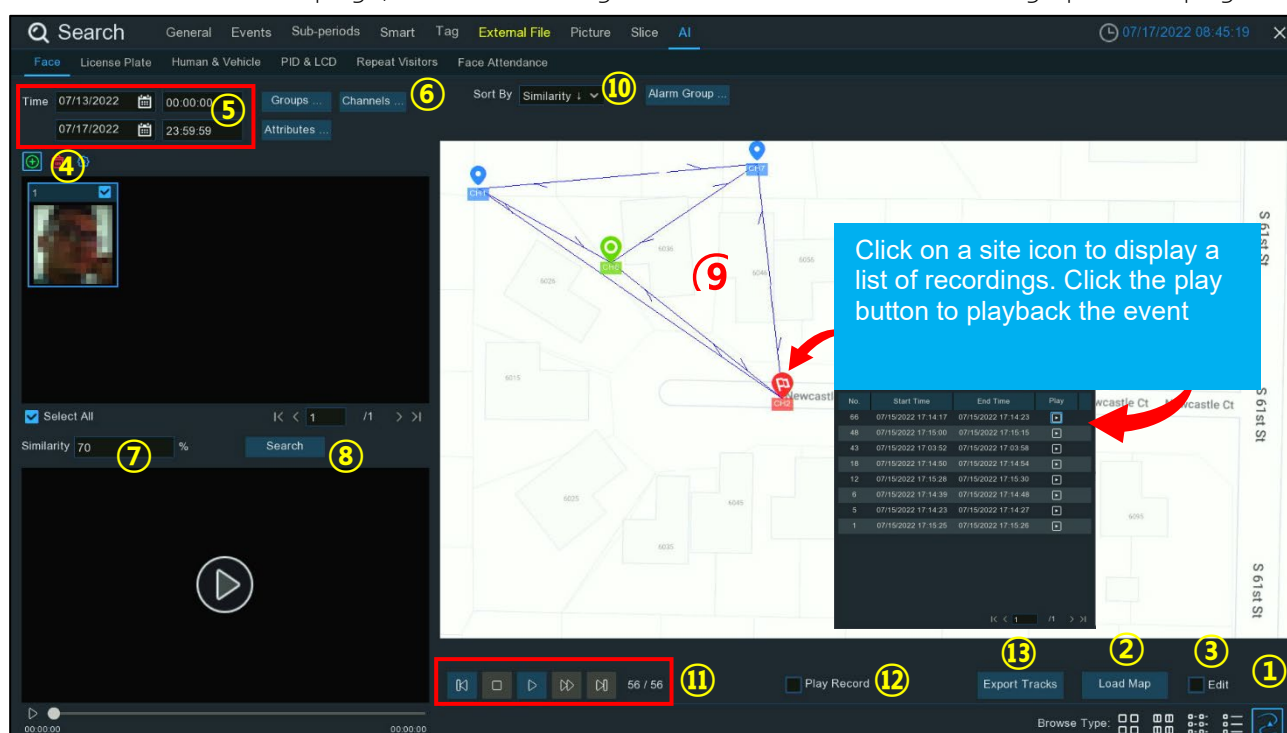

The screenshot shows the NVR software interface with the following numbered callouts:

- 1: Edit button
- 2: Load Map button
- 3: Edit checkbox
- 4: Tracking button
- 5: Time selection fields
- 6: Groups and Channels filters
- 7: Similarity percentage field
- 8: Search button
- 9: Site icon on the map
- 10: Sort By dropdown menu
- 11: Playback controls (play, stop, previous, next)
- 12: Play Record button
- 13: Export Tracks button

A blue callout box points to a site icon on the map with the text: "Click on a site icon to display a list of recordings. Click the play button to playback the event".



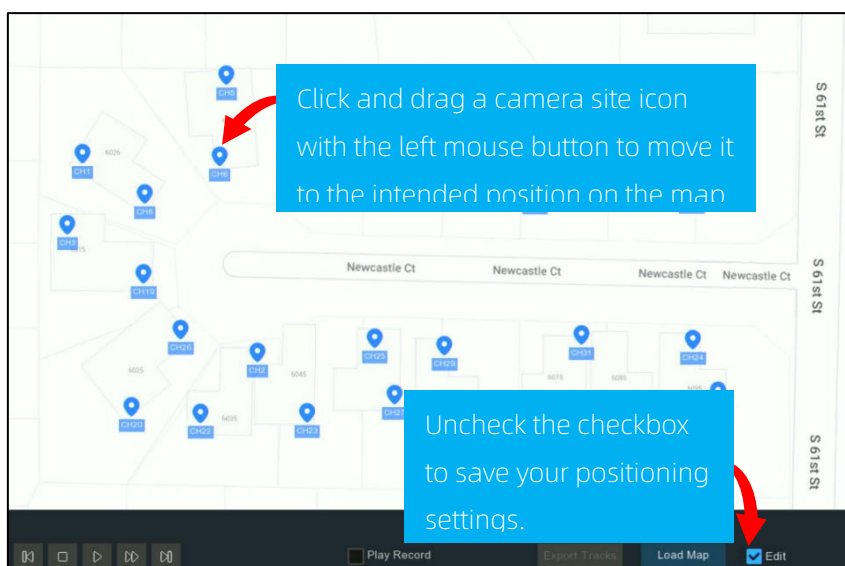

No.	Start Time	End Time	Play
56	07/15/2022 17:14:17	07/15/2022 17:14:23	<input type="checkbox"/>
48	07/15/2022 17:15:00	07/15/2022 17:15:15	<input type="checkbox"/>
43	07/15/2022 17:03:52	07/15/2022 17:03:58	<input type="checkbox"/>
18	07/15/2022 17:14:50	07/15/2022 17:14:54	<input type="checkbox"/>
12	07/15/2022 17:15:28	07/15/2022 17:15:30	<input type="checkbox"/>
6	07/15/2022 17:14:36	07/15/2022 17:14:48	<input type="checkbox"/>
5	07/15/2022 17:14:23	07/15/2022 17:14:27	<input type="checkbox"/>
1	07/15/2022 17:15:25	07/15/2022 17:15:26	<input type="checkbox"/>

2. Click the **"Load Map"** button to load a map image from your USB flash drive.
3. Check the **"Edit"** checkbox, you will see site icons  equal to the number of your NVR channels. You can reposition the camera icons to the desired locations on the map.

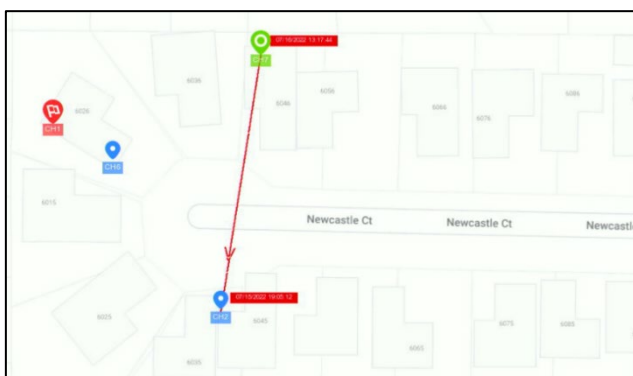







4. Click the add button , and then select a face image from an internal or external storage device. **Note:** The system supports tracking only one face at a time
5. Click the calendar icon to select a date to search. A red underline indicates snapshots were captured on those dates. For the time range, you can search the full 24 hours or use the keypad to specify a start and end time.
6. By default, the system searches all channels. You can click the "Channels" button to select specific channel(s) to search.
7. Set the **Similarity**: Adjust how closely (in percentage) the detected face must match the targeted face to be considered a match. The default threshold is 70%. A higher similarity percentage will result in fewer false recognition results.
8. Click the "Search" button to commence the search.
9. After a while, several camera site icons will be displayed on the map with different colors and symbols. It shows when and where the person was first detected, and when and where they were last detected by a camera.



-  First Detected Point
-  Last Detected Point
-  First & Last Detected Point
-  Waypoint

- Click to choose "Time ↑" to sort the events from oldest to newest.
- Click the play button ▶ to start an animated demonstration of the person's movement path.

Use the following buttons to control playback:

	Click to display previous movement
	Stop
	Play
	Pause
	Click to adjust the play speed
	Click to display next movement



- If you check the "Play Record" box, the movement path animation will be played together with the event recording.
- Export the tracking data for the selected time period to a USB flash drive. The file will be saved in Excel format. You can open the file in Excel (or similar software) for further data analysis.

7.9.2 Search License Plate

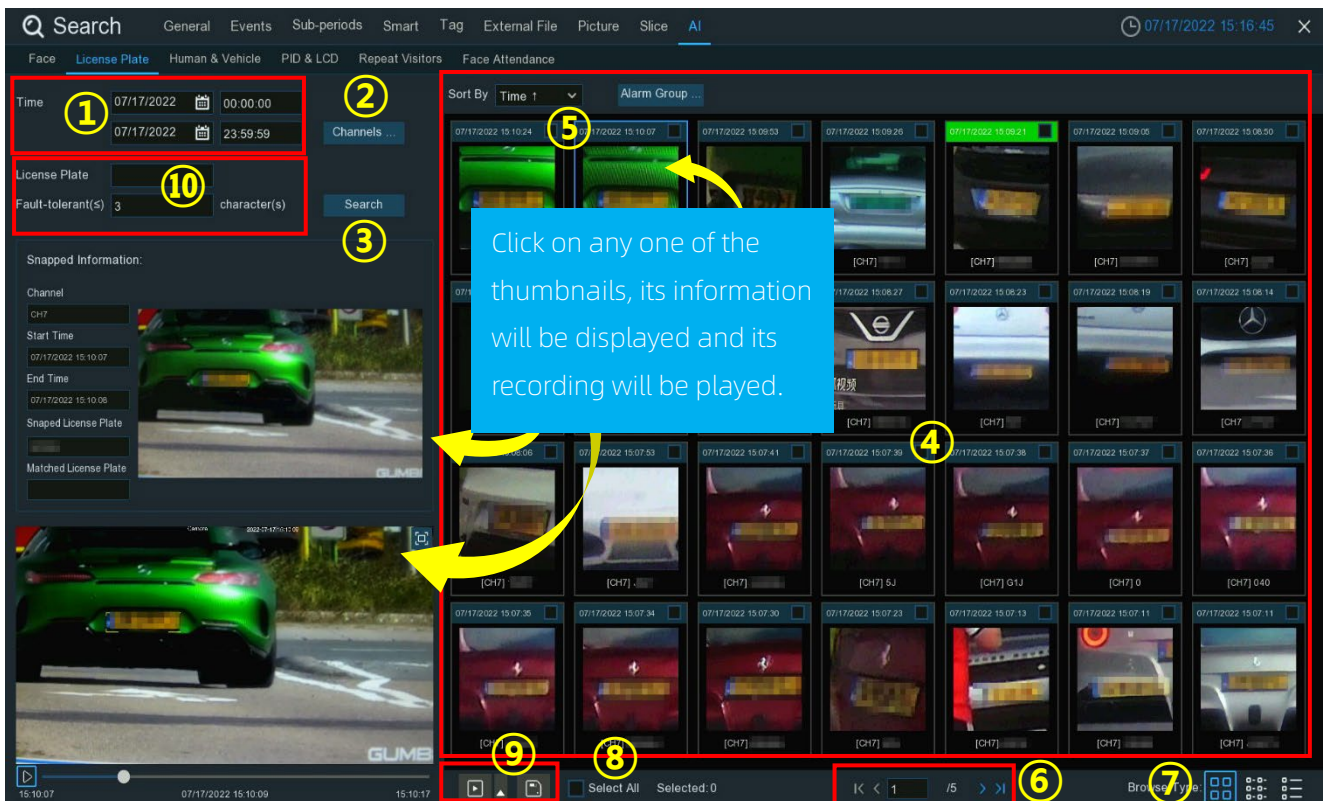
Click **License Plate** tab to enter the license search section, if you have enabled the license plate detection in camera(s), you will see the license detection events captured on current day.



The screenshot displays the NVR search interface for license plates. The interface includes a search bar at the top left, a navigation menu with tabs like "General", "Events", "Sub-periods", "Smart", "Tag", "External File", "Picture", "Slice", and "AI". The "License Plate" tab is selected. On the left, there are search filters for "Time" (1), "License Plate" (10), and "Fault-tolerant(s)" (3). A "Search" button (3) is located below these filters. The main area shows a grid of event thumbnails (5) with a "Sort By" dropdown set to "Time ↑". A blue callout box (4) points to a thumbnail, stating: "Click on any one of the thumbnails, its information will be displayed and its recording will be played." The bottom of the interface features a playback control bar (6) with a play button (9), "Select All" (8), and navigation buttons (7).

1. Click the calendar icon to select a date to search. A red underline on a date indicates license plates were captured on those particular dates. To specify the time range, use the keypad to enter a specific start and end time.
2. The system searches all channels by default. You can click the "Channels" button to select specific channel(s) you want to search.
3. Click the Search button to commence the search.
4. The search results will be displayed on the right side of the screen.
5. You can change the order to display the images in ascending or descending time.
6. Use the arrow buttons to navigate through pages or use the keypad to jump to a specific page.
7. Click these buttons to change how the events are displayed. The default is Thumbnail view, but you can switch to List or Detail view.
8. Check the box above each event to select it, or check the "Select All" box to select all events on the current page.
9. After selecting the files, you can directly click the play button  to play the recording file captured at that time. You can also click the triangle icon  next to it to select the delay time for playing the video, with the following options: 5s, 10s, 20s, 30s, 1min, 2min, 5min, 10min and Custom Playback.

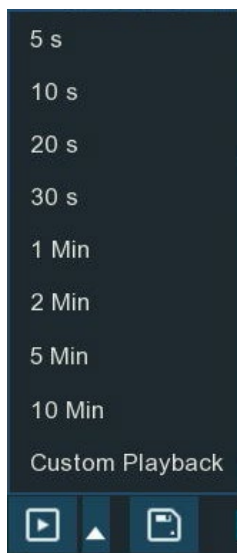

In Custom Playback, you can set how long to extend the playback time before and after the capture.

You can also click the save button  to make a backup. You can choose to save picture files and/or video files. When selecting video files, you can pick the file format for saving. If you choose the RF format, you have the option to encrypt the saved files. Encrypted files require using a dedicated player and entering a password to view them.

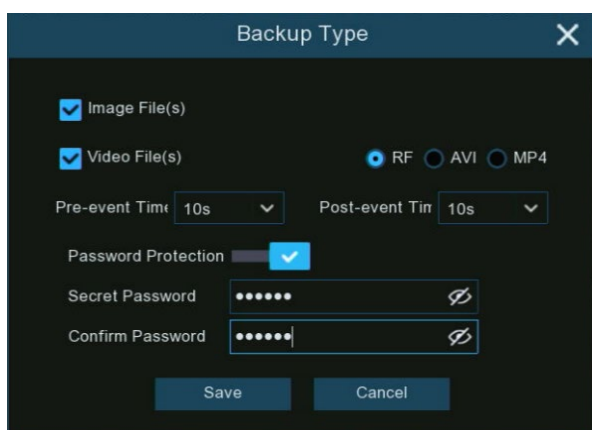

You can also define the length of the video clips to save by setting the Pre-event Time and Post-event Time. These settings determine how much recording time is included before and after the detected event itself.

10. You can input the license number and set the number of **Fault Tolerance** to narrow your search.
11. **Fault Tolerance**: Varies in image resolution, light strength, camera angles, moving speed of the vehicle and etc., character(s) in the license plate number might be failed to recognize. Set the Fault Tolerance that how many characters the detected license allowed to be different from the license number saved in the group. If the number of difference characters between the detected license number and a license profile in the group is no more than the set value, the detected license will be considered a recognized match.

Recognized License Number	Input Number	Fault Tolerance	Recognition Result
AB123C	AB-123-C	≤2 characters	True
AB123C	AB-123-C	≤0 or 1 character	False
A8123C	AB123C	≤2 characters	True
A8123C	AB123C	≤0 or 1 character	False
B594SB	B734KB	≤3 characters	True
B594SB	B734KB	≤2 character	False
AB132C	AB123C	≤2 characters	True
AB123C	AB123C	≤1 or 1 character	True

Samples for true of false result



Note: Only English letters and digit numbers will be recognized by the system, special symbols, like underline , virgule /, hyphen -, will be excluded from being recognized. Please set the Fault Tolerance accordingly if you have input special symbols in the license number when creating a license profile.

7.9.3 Search for Perimeter Intrusion & Line Crossing Events

You can search for perimeter intrusion detection and line crossing detection events that have been captured by enabled cameras.

The screenshot displays the NVR search interface. At the top, there are tabs for 'Search', 'General', 'Events', 'Sub-periods', 'Smart', 'Tag', 'External File', 'Picture', 'Slice', and 'AI'. The 'Search' tab is active. Below the tabs, there are several sections:

- Search Filters:** Includes a date range selector (1) with a calendar icon, target type checkboxes for 'Human' (2), 'Motor Vehicle', and 'Non-motorized Vehicle', a 'Vigilance' dropdown (3), a 'Channels' dropdown (4), and a 'Search' button (5).
- Sorted Information:** Shows 'Start Time' and 'End Time' for the selected event, along with 'ID' and 'Type'.
- Search Results:** A grid of 16 thumbnails (6) showing detection events. A yellow arrow points to one thumbnail, and a blue callout box says: 'Click on any one of the thumbnails, its information will be displayed and its recording will be played.' A 'Sort By' dropdown (7) is set to 'Time ↓'.
- Playback Controls:** At the bottom, there are navigation arrows (8), a 'Select All' button (10), a 'Selected: 0' indicator, a play button (11), and a 'Browse Type' dropdown (9).

1. Use the calendar icon to select a start date and end date range. Dates with detection event recordings are underlined in red. Enter specific start and end times using the keypad.
2. Select the type(s) of targets you want to search for.
3. Choose whether to search for Perimeter Intrusion events, Line Crossing events, or both in the "Vigilance" section.
4. By default, all channels are searched. Click "Channels" to pick specific camera channels.
5. Click the "Search" button to start the search.
6. Search results are displayed on the right side.
7. Change the ordering of results to ascending or descending by time.
8. Use the arrow buttons or keypad to navigate between pages of results.
9. Switch between thumbnail, list, and detailed view modes for the events.
10. Check boxes let you select specific events or all events on the current page.
11. After selecting the files, you can directly click the play button  to play the recording file captured at that time. You can also click the triangle icon  next to it to select the delay time for playing the video, with the following options: 5s, 10s, 20s, 30s, 1min, 2min, 5min, 10min and Custom Playback.

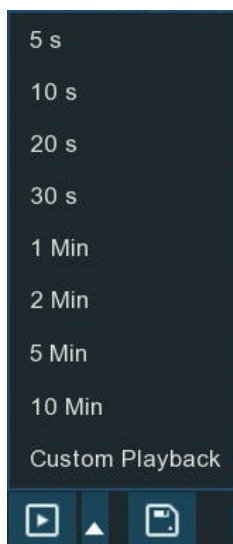

In Custom Playback, you can set how long to extend the playback time before and after the capture.

You can click the save button  to make a backup. You can choose to save picture files and/or video files. When selecting video files, you can pick the file format for saving. If you choose the RF format, you have the option to encrypt the saved files. Encrypted files require using a dedicated player and entering a password to view them.

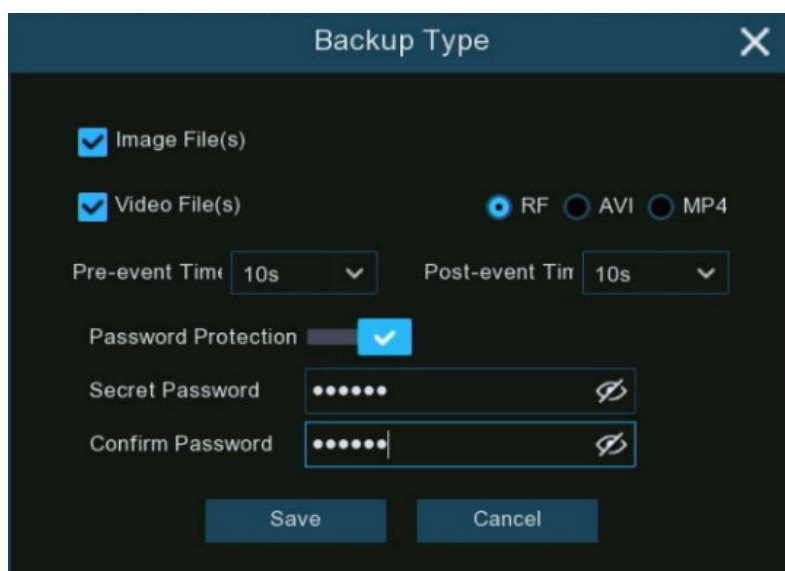

You can also define the length of the video clips to save by setting the Pre-event Time and Post-event Time. These settings determine how much recording time is included before and after the detected event itself.



7.9.4 Intrusion (Enter Region & Exit Region)

You can search for view, backup captured images and recordings triggered by Intrusion Detection events (including entering a region and exiting a region).

The screenshot shows the NVR search interface for Intrusion events. The interface includes a search bar, filters for event types (Pedestrian, Motor Vehicle, Non-motorized Vehicle), a date range selector, a "Search" button, and a grid of video thumbnails. A blue callout box points to a thumbnail with the text: "Click on any one of the thumbnails, its information will be displayed and its recording will be played." The interface also shows a "Snapped Information" panel on the left and a playback control bar at the bottom.

1. Use the calendar icon to select a start date and end date range. Dates with detection event recordings are underlined in red. Enter specific start and end times using the keypad.
2. Select the type(s) of targets you want to search for.
3. By default, all channels are searched. Click "Channels" to pick specific camera channels.
4. Click the "Search" button to start the search.
5. Search results are displayed on the right side.
6. Change the ordering of results to ascending or descending by time.
7. Use the arrow buttons or keypad to navigate between pages of results.
8. Switch between thumbnail, list, and detailed view modes for the events.
9. Check boxes let you select specific events or all events on the current page.
10. After selecting the files, you can directly click the play button  to play the recording file captured at that time. You can also click the triangle icon  next to it to select the delay time for playing the video, with the following options: 5s, 10s, 20s, 30s, 1min, 2min, 5min, 10min and Custom Playback.

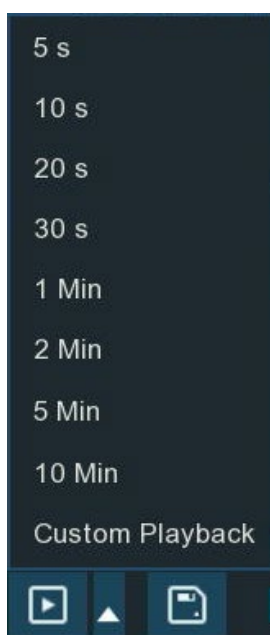

In Custom Playback, you can set how long to extend the playback time before and after the capture.

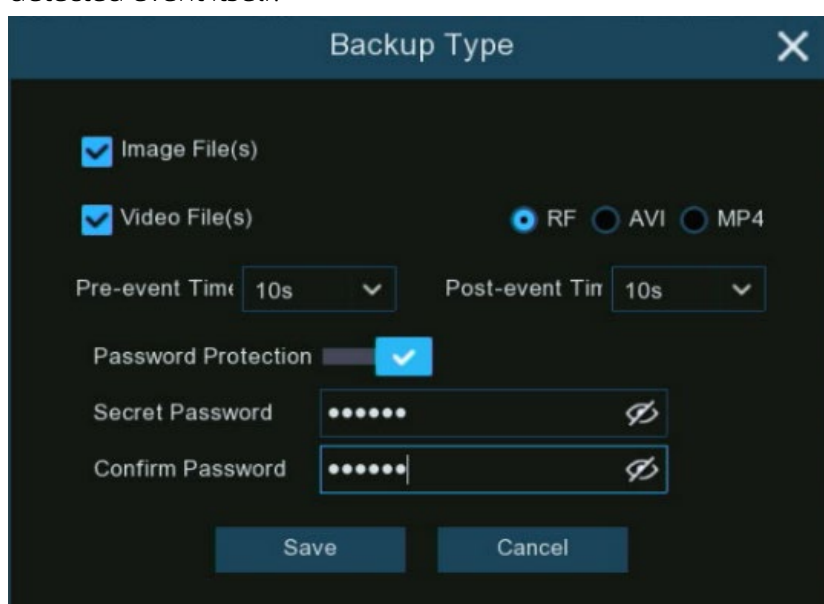

You can click the save button  to make a backup. You can choose to save picture files and/or video files. When selecting video files, you can pick the file format for saving. If you choose the RF format, you have the option to encrypt the saved files. Encrypted files require using a dedicated player and entering a password to view them.

You can also define the length of the video clips to save by setting the Pre-event Time and Post-event Time. These settings determine how much recording time is included before and after the detected event itself.



7.9.5 Repeat Visitors

This is a function to fast search the frequency of occurrence of persons in a certain time period, allowing you to quickly identify and track individuals who have appeared multiple times within the specified date and time range.

1. Use the calendar to select the date range to search. Enter specific start and end times using the keypad.
2. By default, all camera channels are searched. Click "Channels" to select specific channels.
3. Click "Search" to begin the search.
4. Results display on the right, with the "Appeared Times" under each thumbnail indicating how often that individual was captured during the search period.
5. Enter a "Min. Appearance Times" number to hide results for individuals captured fewer times than that minimum.
6. Sort the results in ascending or descending order by time or by frequency of appearance.
7. Use the arrow buttons or keypad to navigate between result pages.
8. Check boxes to select specific results, or **Select All** on the current page.
9. After selecting the files, you can directly click the play button  to play the recording file captured at that time. You can also click the triangle icon  next to it to select the delay time for playing the video, with the following options: 5s, 10s, 20s, 30s, 1min, 2min, 5min, 10min and Custom Playback.

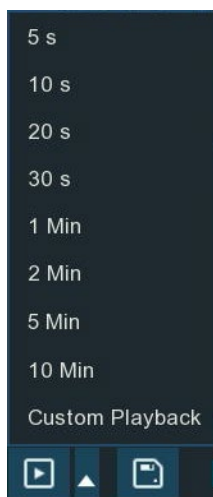

In Custom Playback, you can set how long to extend the playback time before and after the capture.

You can click the save button  to make a backup. You can choose to save picture files and/or video files. When selecting video files, you can pick the file format for saving. If you choose the RF format, you have the option to encrypt the saved files. Encrypted files require using a dedicated player and entering a password to view them.

You can also define the length of the video clips to save by setting the Pre-event Time and Post-event Time. These settings determine how much recording time is included before and after the detected event itself.

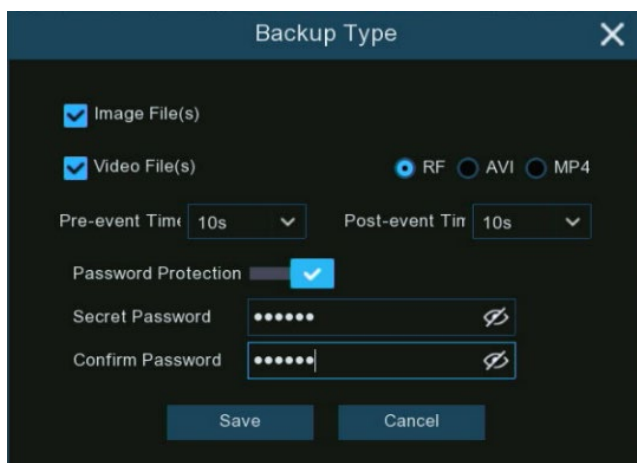

10. Refine your search further by adjusting the "Min. Interval" time to reduce displays of the same person captured repeatedly within a short timeframe. The "Similarity" percentage sets how closely faces must match to be considered the same individual.
11. Click "Attributes" to filter by facial features like gender, age, etc. then search again.
12. By default, all captured faces in the period are shown. Click Groups to instead search only against faces stored in selected face groups.

7.9.6 Face Attendance

The Face Attendance function utilizes facial recognition technology to assist with attendance management. It can automatically record employees' clock-in and clock-out times and analyze cases of tardiness, early departures, and absenteeism.

By selecting specific camera channels, employee groups or individuals, and setting parameters like date ranges and scheduled work hours, the system will search for and log the facial images and video recordings of those employees captured by the cameras during that time period.

Using this function, managers can easily review employees' actual clock-in and clock-out times, identify any instances of tardiness, early departures or absences, and therefore better monitor attendance and discipline issues. Attendance data can also be exported for reporting purposes.

It's important to note that while Face Attendance automates and streamlines the attendance tracking process through facial recognition, it should not be solely relied upon in case of system failures. The function is an attendance management aid, but other methods should still be used to comprehensively verify attendance records.



No.	Name	Group	Detail	12/05	12/06	12/07	12/08	12/09	12/10	12/11	Late	Leave Early
2	F-167	Allow List		○	○	○	○	○	○	○	0	0
3	F-168	Allow List		○	○	○	○	○	○	○	0	0
4	F-169	Allow List		○	○	○	○	○	○	○	1	1
5	F-172	Allow List		○	○	○	○	○	○	○	1	1
6	F-173	Allow List		○	○	○	○	○	○	○	1	1
7	David Wilson	Block List		○	○	○	○	○	○	○	0	0
8	Anna Joyce	Block List		○	○	○	○	○	○	○	0	0
9	Nora Martins	Block List		○	○	○	○	○	○	○	0	0
10	Shelly Clinton	Block List		○	○	○	○	○	○	○	0	0
11	Sinna Donald	Block List		○	○	○	○	○	○	○	0	0

1. Select the camera channel(s).
2. You have the option to search either **By Group** or **By Person**.
 - If searching By Group, the system will include all persons belonging to the selected group(s) in the search. Groups are pre-configured collections of multiple people's information stored



in the system. Searching by group allows you to quickly retrieve attendance data for an entire department or team.

- If searching By Person, only the specific individual(s) you manually select will be included in the search. This person-based approach provides more flexibility to review the attendance records of designated employees as needed.

Regardless of whether searching by group or individual, you need to click the filter icon  to check the boxes next to the desired group(s) or person(s) from the respective lists. Your selections will then be displayed in the window on the left middle area of the screen.

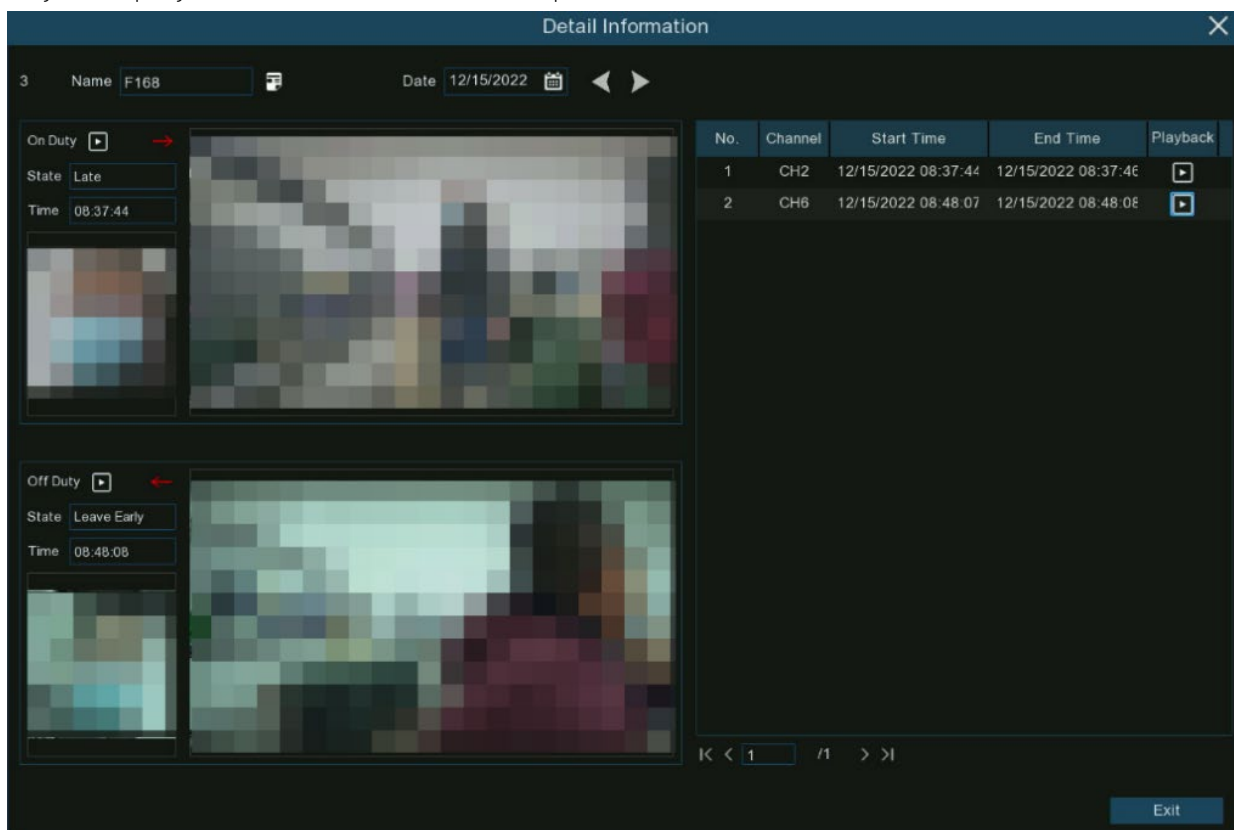
3. Select the search date range - individual day, week, month, current day or custom range.
4. Set the **Working Days**.
5. Set the Set the start time and end time for the on-duty period
6. Click **Search**, and results will display on the right side.
7. You can export the attendance data to a USB drive or send it via email.
8. Click the detail icon  to see the first and last captured images/videos of each person for that day. Click play button  to review the clips.



No.	Channel	Start Time	End Time	Playback
1	CH2	12/15/2022 08:37:44	12/15/2022 08:37:46	
2	CH6	12/15/2022 08:48:07	12/15/2022 08:48:08	

Chapter 8 Remote Access Through the Web Client

You can use the web client on a PC to access the device remotely at any time. Before using the web client, you need to ensure that the device network is functioning properly.

8.1 Basic System Environment Requirements

The minimum and recommended requirements for the hardware and operating system to run the web client smoothly are as follows:

Item	Minimum Requirement	Recommended Requirement
CPU	Intel® Core™ i5 CPU	Intel® Core™ i5 CPU or higher
RAM	≥ 4 GB	≥ 8 GB
Hard Disk Drive	≥ 500 GB	≥ 1000 GB
Video Memory	≥ 2 GB	≥ 4 GB
Display Resolution	1280 x 1024	1920 x 1080
Operating System	Windows 7 or above, Mac OS X® 10.9 or above	
DirectX	DirectX 11	
Direct 3D	Acceleration Function	
Ethernet Adapter	10/100/1000 Mbps Ethernet Adapter	
Internet Explorer (IE)	Microsoft Internet Explorer (version: V11, V10)	
Firefox	V52 or above	
Google Chrome	V57 or above	
Apple Safari	V12.1 or above	
Edge	V79 or above (using the Chromium core)	

8.2 Web Plug-in Downloading and Installation

When you use Internet Explorer to access the NVR for the first time, you need to download the Web Client plugin. Please refer to the following steps:

1. Open Internet Explorer and enter the IP address or "DDNS + port number" of the NVR device in the address bar.
2. On the login page, enter the correct username and password to access the web client. (Note: If you enter an incorrect password five consecutive times, your account will be locked for 180 seconds.)

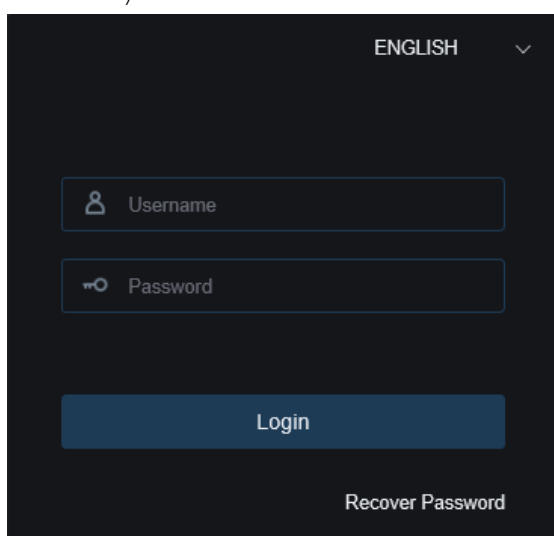

2. When accessing the web client through Internet Explorer for the first time, the system will prompt you to install a plugin. Click "[Download and install the player](#)" to download the plugin.

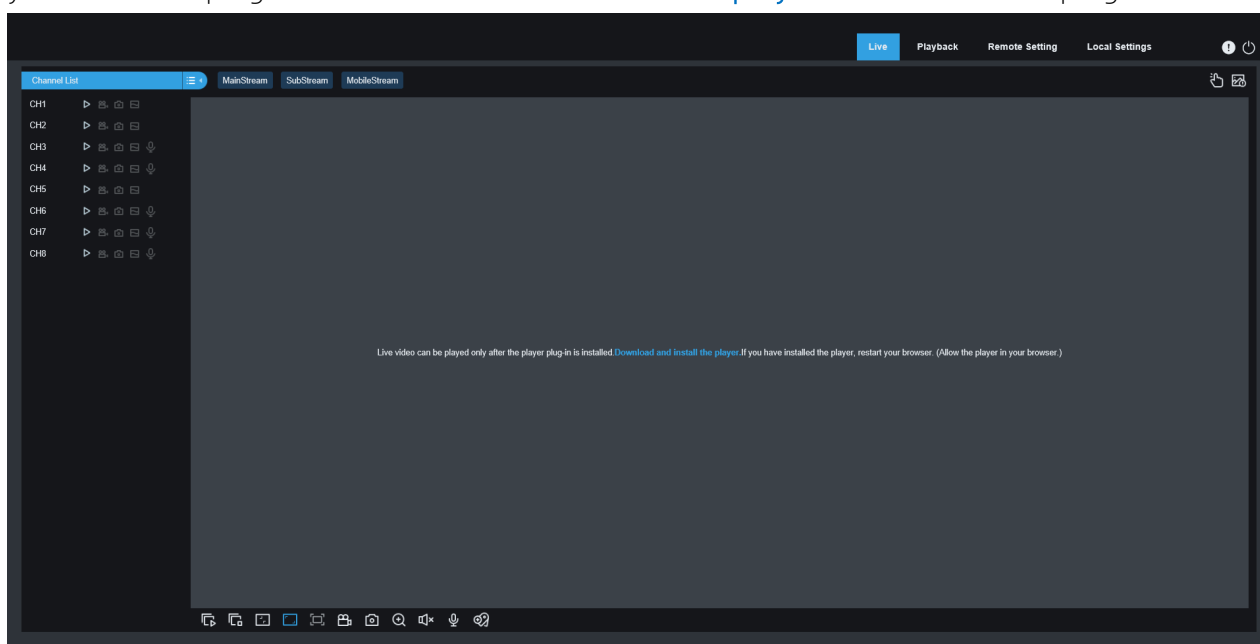

- Once the plugin download is complete, run the installer and follow the on-screen instructions to install the plugin on your computer.

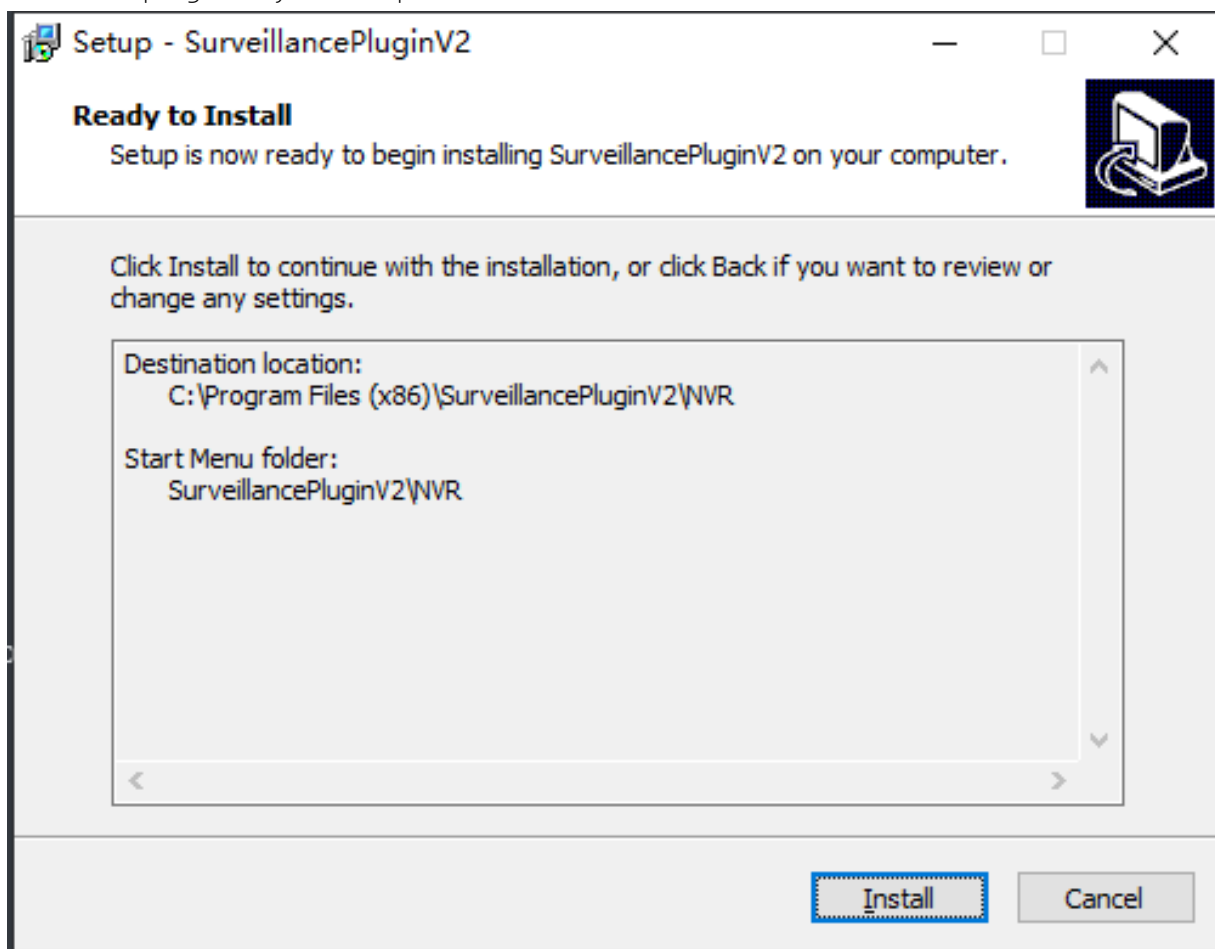

- After successful installation, return to the web browser and refresh the page. You may see a pop-up dialog box at the bottom of the page asking for permission to run the plugin. Click "Allow" to grant permission.
- The web client should now load properly, allowing you to view and interact with the NVR interface through Internet Explorer.

Note:

- Please ensure that you have the necessary permissions to install software on your computer before proceeding with the plugin installation. If you encounter any issues during the process, refer to the documentation or contact support for further assistance.
- If you are using web browsers other than Internet Explorer, such as Apple Safari, Google Chrome, Firefox, or Microsoft Edge, you do not need to download and install any additional plugin. You can directly log in to the NVR device through these browsers without any extra steps.

8.3 Web Client Management

This section will mainly introduce the Web Client interface and basic operation methods. For the usage of specific function menus, please refer to the usage methods of the corresponding functions on the local NVR client.

8.3.1 Login Interface Introduction

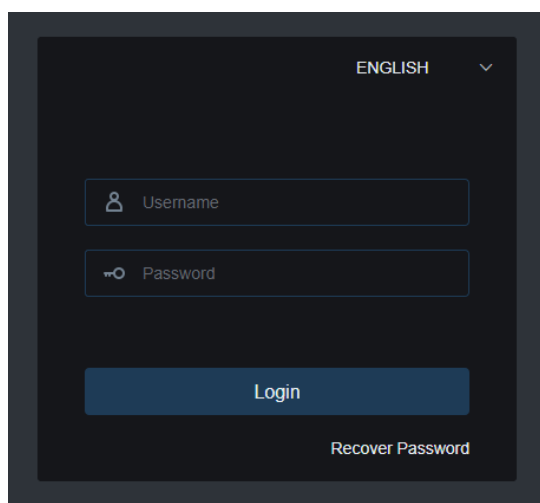

1. Open a web browser and enter the IP address or "DDNS + port number" of the NVR device in the address bar.
2. On the login page, enter the correct username and password to access the web client. (Note: If you enter an incorrect password five consecutive times, your account will be locked for 180 seconds.)
3. You can click the language selection drop-down in the top right corner to choose your preferred supported interface language.
4. If you have forgotten your login password, please click the "[Recover Password](#)" button and follow the prompts to reset your password.

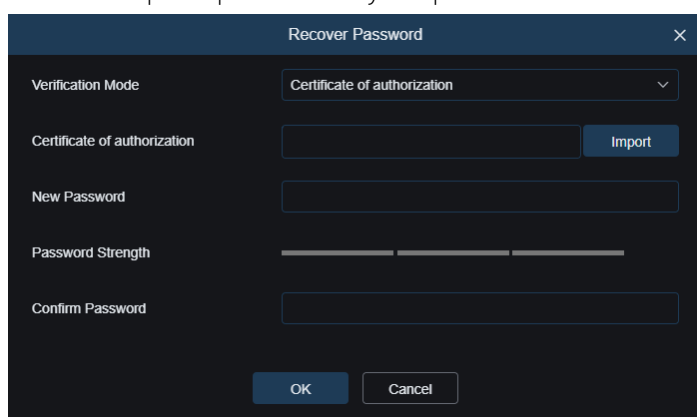



Please refer to the methods described in section [3.3.1.1 "Forgot Password"](#) to reset your password.

8.3.2 Main Interface Introduction

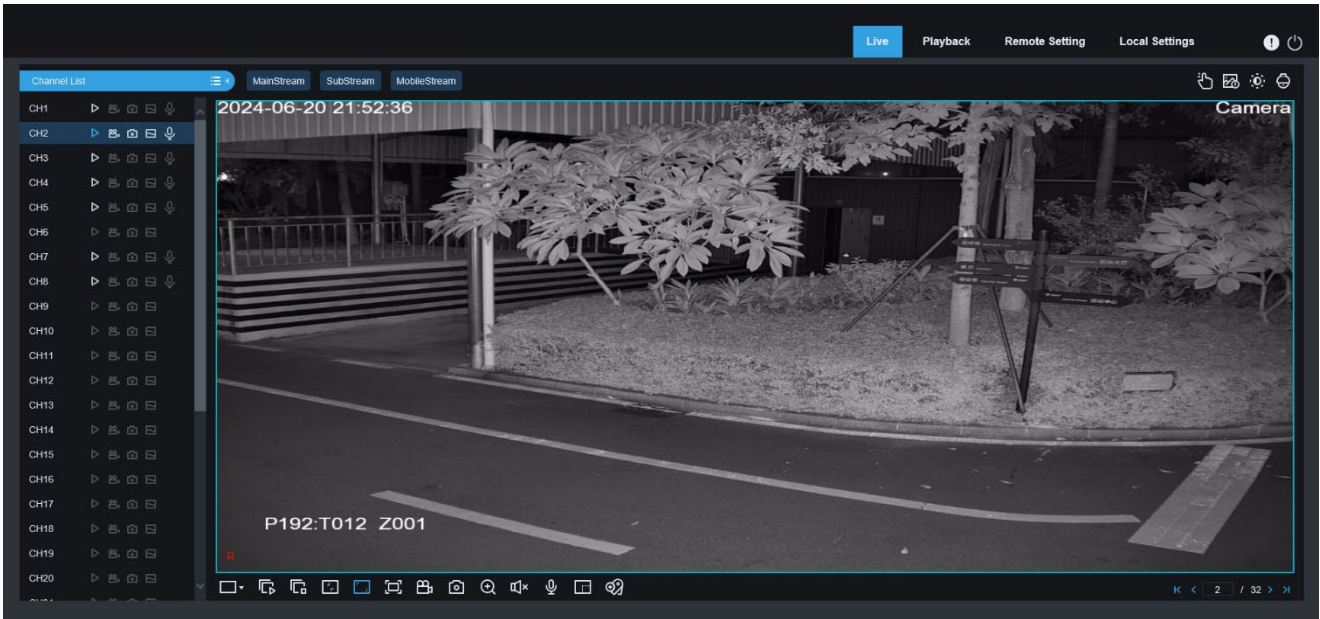
After successfully logging in, you will arrive at the main page of the Web Client.



- **Live:** Click to enter the live preview interface
- **Playback:** Click to enter the live preview interface
- **Remote Setting:** Click to enter the live preview interface
- **Local Settings:** Click to access local save parameter settings (This menu will only show when logged in using IE)
-  Hover over this icon to display the currently logged-in account name, Web Client version, and plugin version. Only effective in IE.
-  Click to log out of the Web Client

8.3.3 Live Preview Interface

On the Live Preview page, you can open or close live preview, manually record video to your local computer, take snapshots of the screen, control PTZ cameras, and adjust color settings, etc.

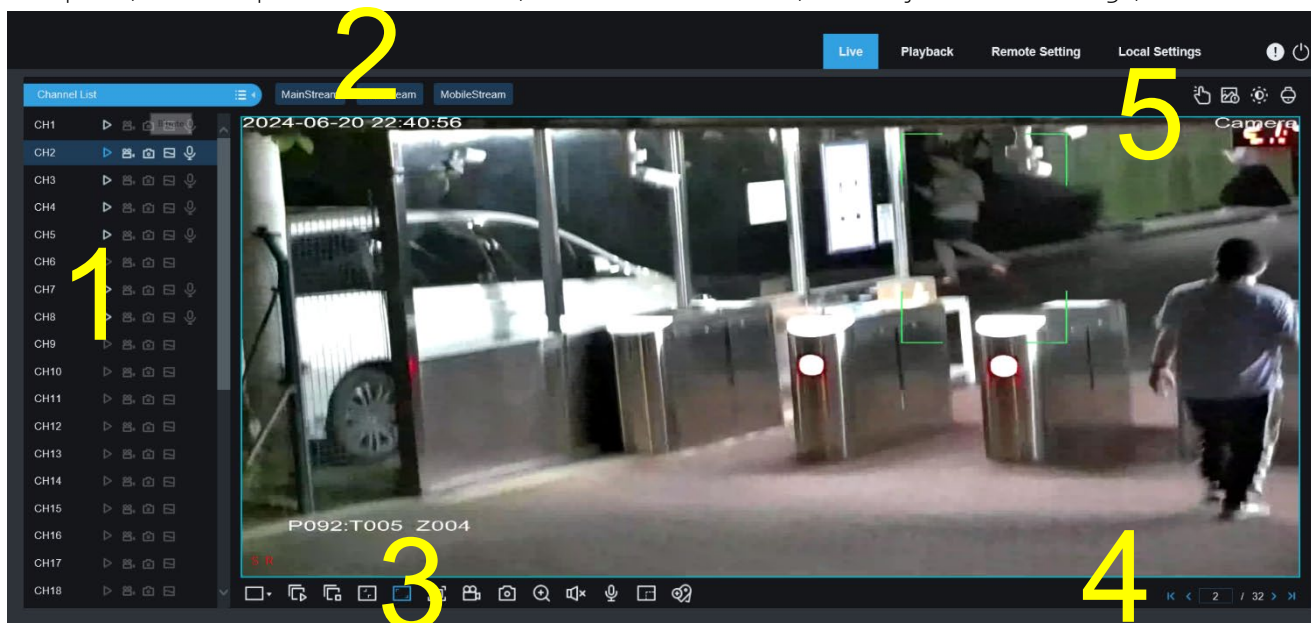

















1. Channel List Controls	
Icons	Description
	Click this icon to hide the channel list
	Click this icon to display the channel list
	Click this icon to enable or disable live video streaming. When live video streaming is enabled, the icon is displayed in blue.
	Click this icon to start recording streaming video manually. Click this icon again to stop recording. The manually recorded video is stored on the computer. During recording, the icon is blue.
	Manual snapshot icon. Click this icon to store the real-time snapshot currently displayed on the computer.
	Bit rate icon. For cameras, main stream, sub-stream, or mobile stream video settings can be used.

2. Stream Switching

When viewing a channel in full-screen mode on the Web Client, it automatically switches to the main stream mode. When viewing multiple channels in split-screen mode, it automatically switches to either sub-stream or mobile stream mode. Users can select the appropriate stream mode for viewing based on their actual network environment and computer configuration. Clicking one of these buttons will simultaneously change the stream mode for all channels currently being previewed.

3. Live View Control Buttons

Icons	Description
	Switch preview display layout
	Open preview for all channels
	Close preview for all channels
	Original Ratio: Display live video in its original aspect ratio
	Stretch: Stretch real-time video to fit the entire area of each channel on the screen
	Maximize the web client to full screen
	Manual Recording: Click to start manual recording for all displayed channels. Click again to stop recording. Manually recorded videos are saved to the computer
	Manual Snapshot: Click to capture the current image of all displayed channels and save to the computer
	Digital Zoom: Click an active image, then click and drag over an area of the active image to zoom in. Right-click to return to normal display
	Volume Control: Adjust volume level.
	Mute mode
	Click to enable two-way audio between client and device, click again to disable (Note: This function requires device support for two-way audio)
	White Light Control: Manually activate white light deterrence (requires camera support)
	Siren Control: Manually activate siren warning (requires camera support)
	Red and Blue Light Control: Manually activate red and blue light warning (requires camera support)
	Click to add custom tag event

4. Preview Channel Switch Button



Click the arrows to switch to the previous or next group of preview channels without changing the current preview channel layout.

4. Preview Channel Switch Button







Function Control button

Manual Alarm: Turn the IO alarm on or off manually

Color setting: Click to display or hide the color control.

AI alarm: Push process of AI alarm events, click  to check the AI push type. The selected type of AI alarm event will be pushed, click  to delete current list.

PTZ control: Click to open or close the PTZ operation menu.

5. Function Control Buttons	
Icons	Description
	Manually turn on or off I/O alarms
	Push notifications for AI alarm events. Click  to select AI push types; selected types of AI alarm events will be pushed. Click  to clear the current push list.
	Click to show or hide color controls
	Click to open or close the PTZ operation menu

5. **Manual Alarm** Manually enable or disable I/O alarms.

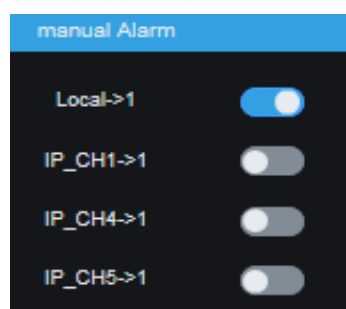

Color: Show or hide the color controls.



2. Stream Switching

When viewing a channel in full-screen mode on the Web Client, it automatically switches to the main stream mode. When viewing multiple channels in split-screen mode, it automatically switches to either sub-stream or mobile stream mode. Users can select the appropriate stream mode for viewing based on their actual network environment and computer configuration. Clicking one of these buttons will simultaneously change the stream mode for all channels currently being previewed.

AI alarm: Push AI alarm events. Click  to select the types of the AI alarm events to be pushed.

Click  to clear the current push list.



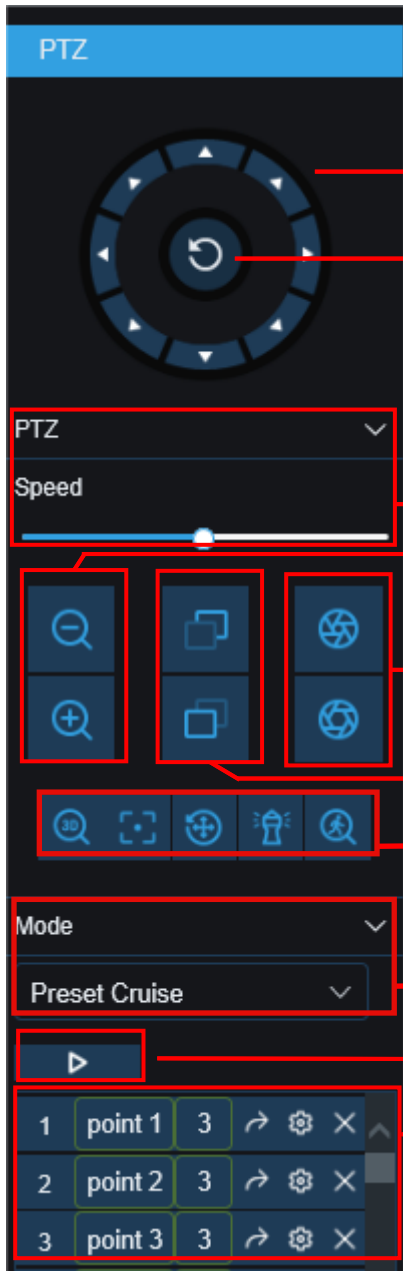

PTZ: Enable or disable the PTZ operation menu.

Arrow keys: Click the arrow keys to rotate the PTZ camera.

Default cruise.

PTZ speed: Set the rotation speed of the PTZ camera.

Zoom: Click -/+ to zoom in or out the image.

Iris: Adjust the iris size.

Focus: Click -/+to adjust the focus.

: 3D PTZ. : Automatic focusing. : Preset point resetting.

: Watch mode. : Manual tracking mode. For detailed

information

Gimbal rotation mode, there are six modes: PTZ, PRESET, Line Scan, Watch Mode, Tour, Pattern Scan.

Cruise: Start/stop gimbal cruise

Preset points: Modify the names of preset points, and go to, add, or delete preset points.

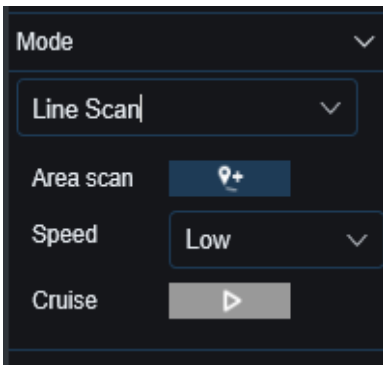

Line Scan page:

Area scan: Click to record the start position and rotate the PTZ camera, and click to record the stop position.

Speed: Select the linear cruise speed.

Click to start linear cruise. In this mode, the PTZ camera moves on the same horizontal plane only.

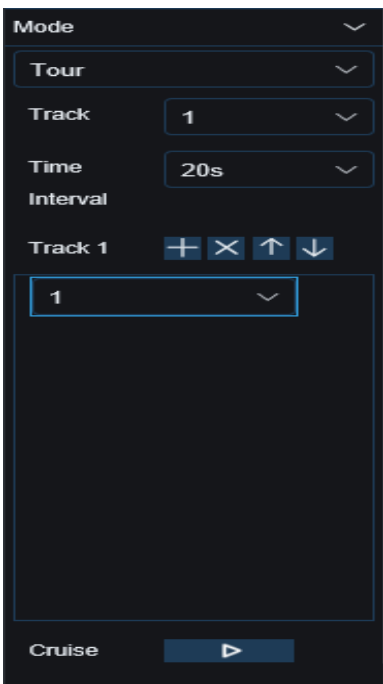

Tour page:

Time Interval: Dwell time at each preset point.

Click to add a preset point. Click to delete the preset

point. Click / to move up/down the preset point. Click to start cruise.

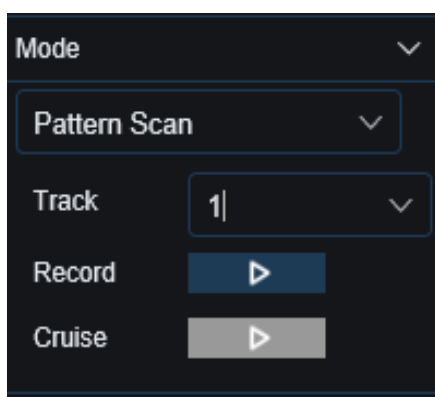

Pattern Scan page:

Record: Click  to start recording the cruise route. Click  to stop recording.

Cruise: Click  to start cruise in accordance with the recorded route and action.

6. Live View Control Buttons



Switch display mode in the channel area.



Open all channel previews.



Close all channel previews.



Original proportions: The live video is displayed in the original proportions.



Stretch: The live video is stretched to fit the entire area of each channel on the screen.



The web client is enlarged to full screen.



Manual recording: Click this icon to start manual recording of all displayed channels. Click this icon again to stop recording. The manually recorded video is stored on the computer.



Manual capture: Click this icon to capture the images of all displayed channels and store them on the computer.



Digital zoom: Click an active image, and drag and drop the mouse to get an area on the active image to zoom it in. Right-click the area to return to normal view.



Volume control: Adjust the volume by adjusting the level value.



: Silence mode.



Intercom: Click this icon to enable the intercom between the client and the device. Click this icon again to disable the intercom with the device. (Note: This function needs to be supported by the device.)

 White light control. White light deterrence can be enabled manually (camera support is required).

 Alarm bell control. Alarm bell can be enabled manually (camera support is required).

 Warning light control. Warning light alarm can be enabled manually (camera support is required).

 Click this icon to add a custom tag event.

6. Display tab switching

8.3.2 Playback Page

On this page, you can search and play back the videos stored on the hard disks of the device, and can download videos to a PC.

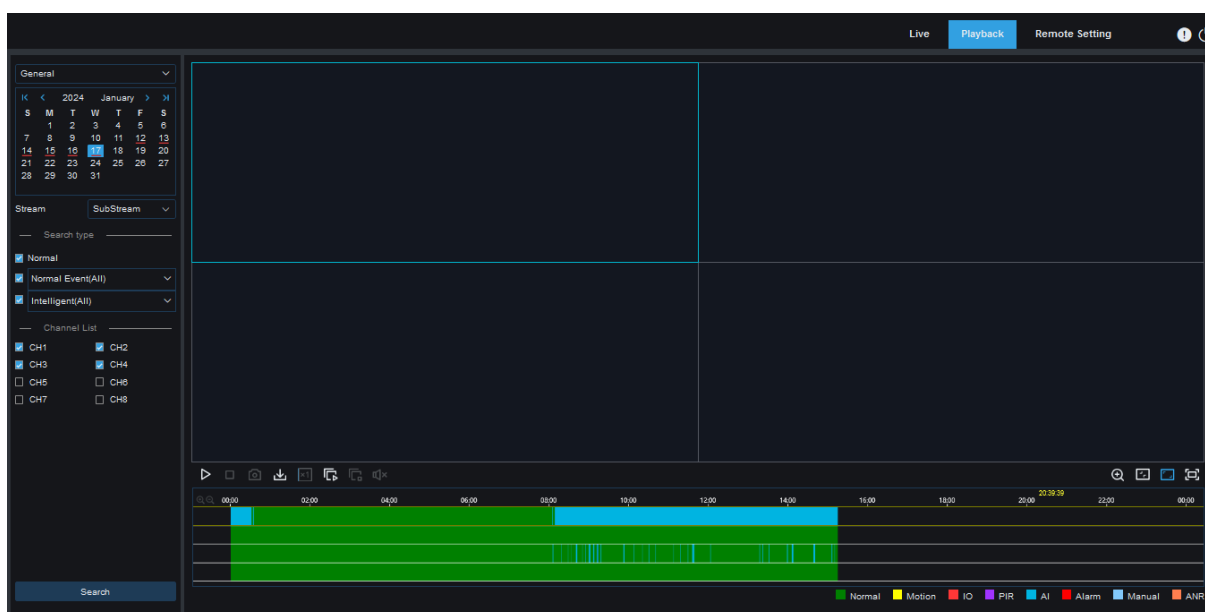

Searching Videos:

1. Click **Playback** in the top right corner to open the **Playback** page.
2. Select the date for video query on the calendar. The days with video recording are underlined in red.
3. In the **Search type** area, select the recording types to be queried. You can also select **All** to query all recording types.
4. Select the video streams to be searched and played.
5. In the **Channel List** area, select the channels of which videos are to be played back. (You can search at most four channels for video playback at the same time.)
6. Click the **Search** button to search videos.

7. The searched videos are displayed on the timeline. Click the video clip to be played, and click ► to play the video.

8.3.4 Playback Interface

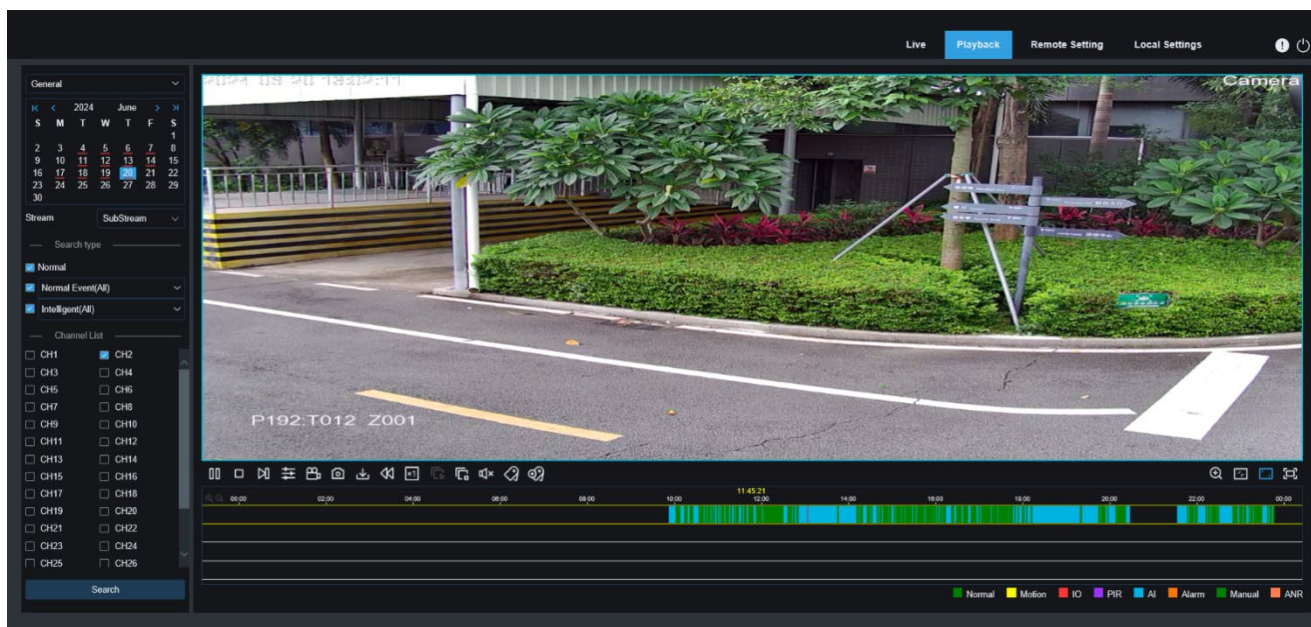

In the dropdown box in the upper left corner, select the search method you want to use: General, Picture, Tag, or AI. After selecting your desired search method, follow the on-screen instructions to proceed. For details on each search method, you can refer to the relevant sections in [Chapter 7 Search, Playback & Backup](#).

8.3.5 Remote Setting Interface

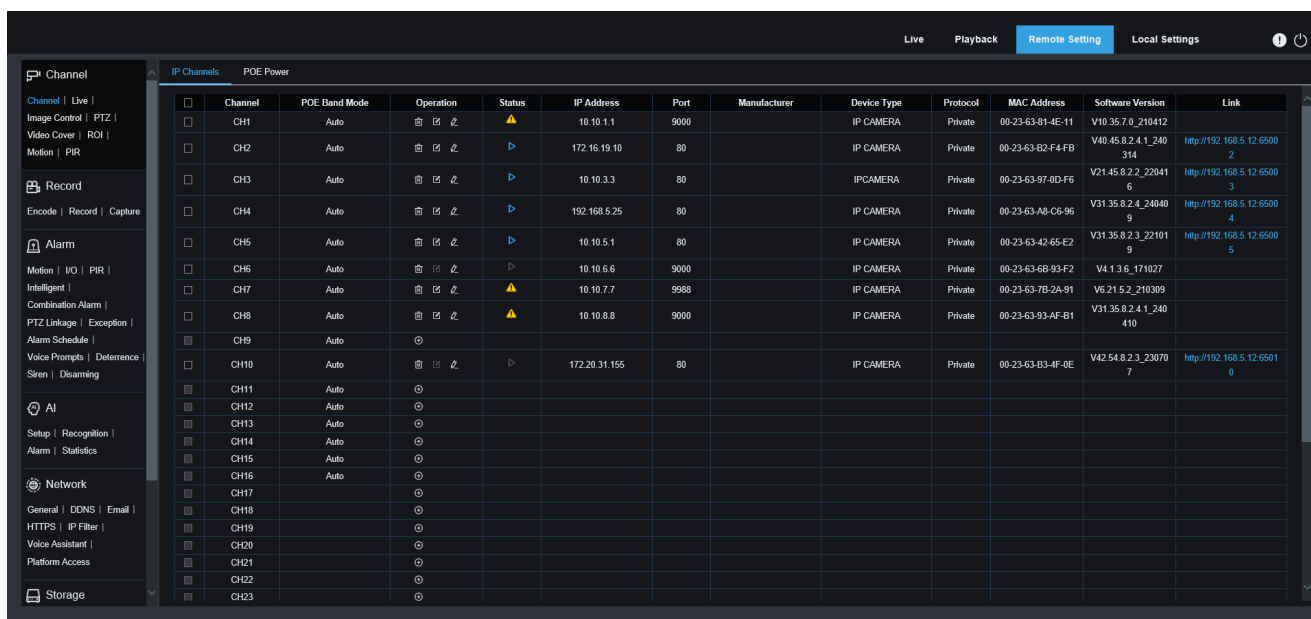

On this page, you can configure the relevant parameters of the NVR. In the sidebar on the left, click on the parameter you need to set to enter the corresponding page. For specific details, please refer to the relevant sections in [Chapter 5 System Setup](#).

It should be especially noted that if you have checked the "[Direct Camera Web Access](#)" option on the local device (refer to [5.5.1.5 Port Configuration](#)), in the IP Channel list on the Channel page, you can directly click on the hyperlink in the Link column of an individual channel to enter the IP Camera's Web client. This allows you to view and configure that IP camera. This function requires support from the IP Camera.

8.3.6 Local Setting Interface

This menu will only show when logged in using IE.

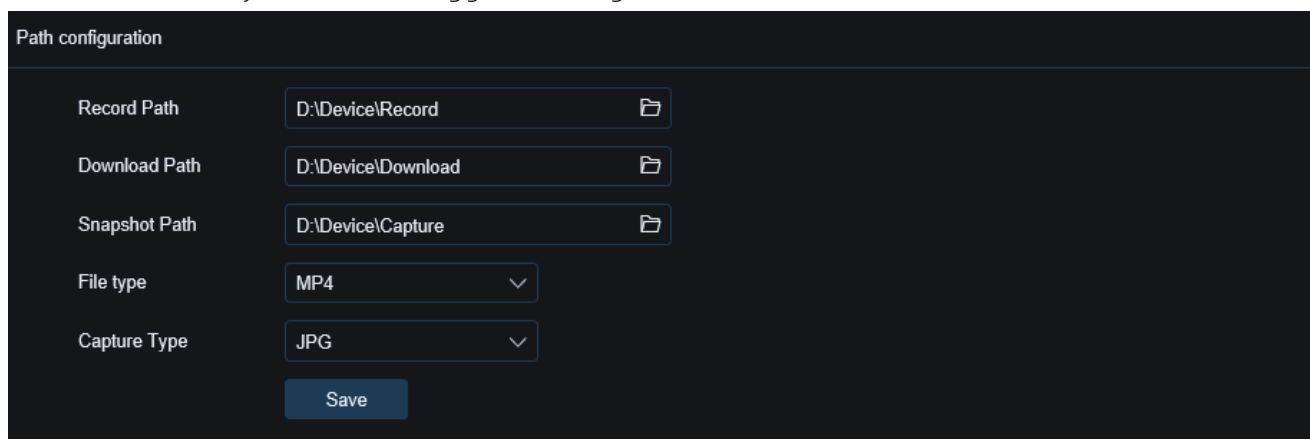

The screenshot displays the 'Path configuration' interface. It features five rows of configuration options:

- Record Path:** A text input field containing 'D:\Device\Record' with a folder icon on the right.
- Download Path:** A text input field containing 'D:\Device\Download' with a folder icon on the right.
- Snapshot Path:** A text input field containing 'D:\Device\Capture' with a folder icon on the right.
- File type:** A dropdown menu currently set to 'MP4'.
- Capture Type:** A dropdown menu currently set to 'JPG'.

At the bottom of the configuration area is a blue 'Save' button.

On this page, you can set the save paths for manual recordings, file downloads, and snapshots. You can also select the format for downloaded recordings and snapshots.

Chapter 9 Backup Video Playing

This chapter describes how to use the VideoPlayer to play the video files backed up from the device.

Minimum Requirements for the Computer System

- CPU: Intel I3 or above
- Operating system: Windows XP/7/8/10/11, MacOS 10
- Memory: 2 GB
- Video memory: 1 GB

1. Install the video player software on the CD and run the program.

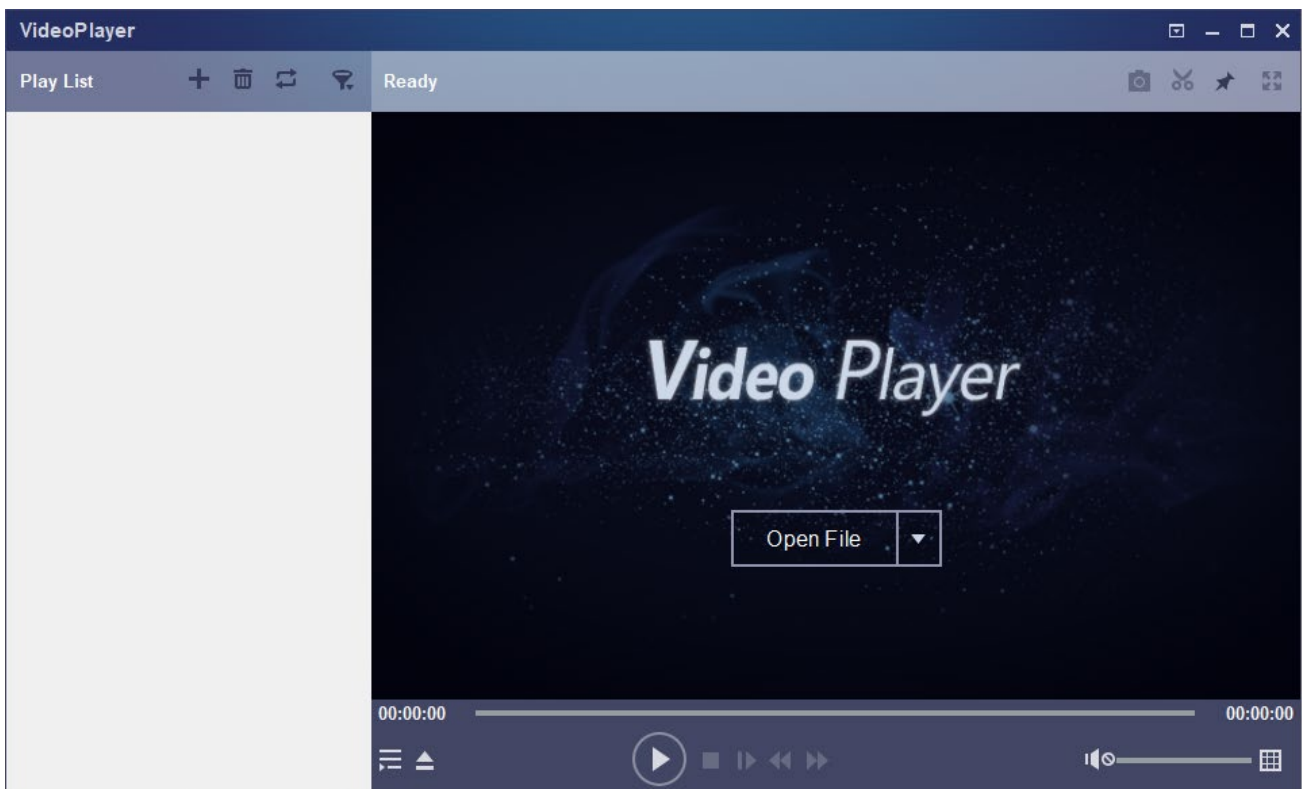





2. Copy the backup file to the computer.
3. Click **Open File** or click the "+" icon in the **Play List** pane to load one or multiple video files. The supported video file formats include .rf, .avi, and .mp4. Click  to load a backed up video file folder.

Video Player Control







1. Play list

-  Add files.
-  Delete files.
-  Select play mode: Play a single file and then stop; play all listed files in sequence; play one file repeatedly; play all files repeatedly.
-  Filter files by file name.

2. Hide/Show the play list.

-  Open a file or load a file folder.

3. Play control

-  Play the video.
-  Pause playing the video.
-  Stop playing the video.
-  Play the video frame by frame: One frame is played every time this icon is clicked.
-  Play the video on a low speed: You can set the video to be played at 1/2, 1/4, 1/8, or 1/16 of the normal play speed.

▶▶ Fast forward: You can set the video to be played at 2x, 4x, 8x, or 16x of the normal play speed.

4.  Volume control.

 Multi-screen play. Multiple videos can be played at a time. After clicking this icon, you can drag the videos in the play list to the play page.

5.  Snapshot.

 Click this icon to store a video clip on the computer. You can click it to start video clipping, and then click it again to stop video clipping.

 Keep the video player at the top.

 Enlarge the video page to full screen.

6.  **Advanced setting menu:** Select language for the video player, and configure the player functions.

Basic Settings: Set how to keep the player at the top.

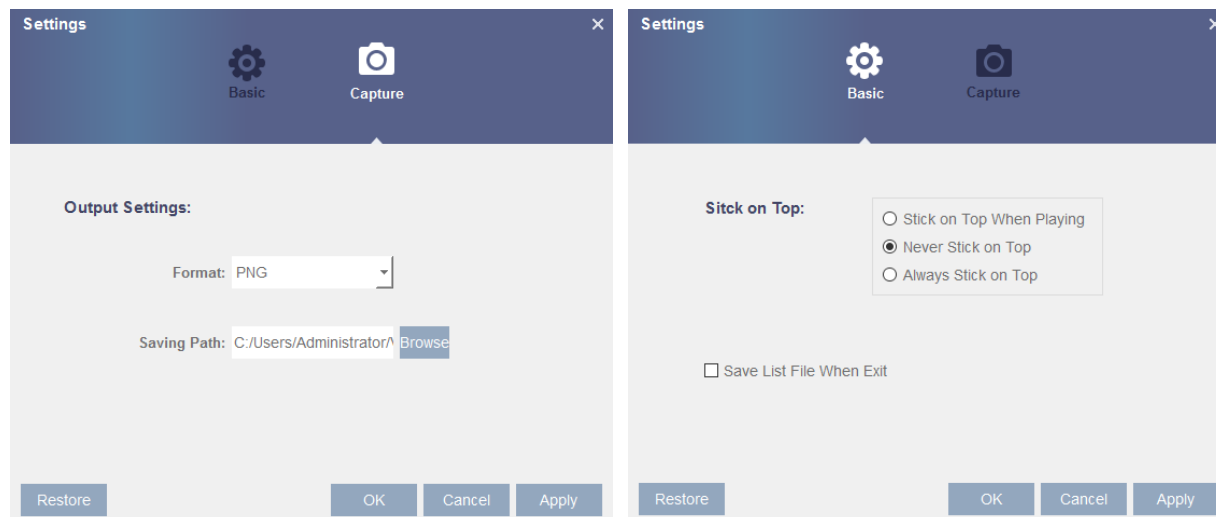

Capture Settings: Set the file format and path for snapshot saving.

Chapter 10 Appendix

10.1 FAQ

1. Q: What should I do if I cannot detect the hard disk?

A: If no hard disk is detected, you need to verify the following:

- (1) The data cable and power cable of the hard disk are well connected.
- (2) The ports of the hard disk on the main board are in good condition.
- (3) The hard disk is supported as described in the specifications.

2. Q: What should I do if I forget the password after I change it?

A: When the administrator forgets the password, you can reset the password through the password retrieval function or restore the factory settings of the device through the physical reset button. It is recommended that you set a password that is both easy to remember and relatively secure.

3. Q: After the device and cameras are connected, the power supply on both ends are normal, but there are no video signals or the outputted images are not normal. Why?

A: Verify that the network cable on the device end is connected properly and is not aging, and verify that the NTSC/PAL system configurations are the same on both ends.

4. Q: What is the effect of heat dissipation on the device itself during operation?

A: Because a certain amount of heat is generated during the device operation, you need to place the device in a safe and well-ventilated environment to prevent the device from having long-term high temperature, which may affect the stability and service life of the system.

5. Q: Why can't the remote control of the device operate while the monitoring screen is normal and the panel buttons can be used?

A: Align the remote control with the IR signal on the front panel of the device when performing check operations. If the remote control still fails, check whether the remote control have sufficient battery capacity. If yes, verify that the remote control is not damaged.

6. Q: Can I use the hard disk drive on my PC in the device?

A: It is recommended that you use a hard disk dedicated for video surveillance to ensure the stability of device operation.

7. Q: Can I play back videos while recording videos?

A: Yes. This device supports that you record videos and play back videos simultaneously.

8. Q: Can I clean up some video records on the hard disk?

A: Considering file security, you cannot clean up some video records. If you really need to delete all the video records, you may format the hard disk.

9. Q: Why can't I log in to the device client?

A: Verify that the network connection configuration is correct and the RJ-45 port has good contact. If the network login password switch is enabled, verify that the user name and password you entered are correct.

10.Q: Why can't I find any recorded information when playing back videos?

A: Verify that the data cable of the hard disk is connected properly and the system time is not adjusted without permission. Try for several times. If the problem persists after restarting, verify that the hard disk is not damaged.

11.Q: Why can't the device control the PTZ?

A: The problem may due to the following causes:

- a) The front-end PTZ is faulty.
- b) The setting, connection, or installation of the PTZ decoder is incorrect.
- c) The PTZ of the device is not configured correctly.
- d) The PTZ decoder protocol does not match the device protocol.
- e) The PTZ decoder address does not match the device address.

12.Q: Why doesn't dynamic detection work?

A: Verify that the motion detection time and motion detection area settings are correct, and verify that the sensitivity setting is not too low.

13. Q: Why do the alarms fail?

A: Verify that the alarm setting, alarm connections, and alarm input signals are correct.

14. Why does the buzzer keep ringing?

A: Check the following items: alarm settings, whether the motion detection function is enabled, whether there are always moving objects detected, and whether the I/O alarm is disabled. Verify that the hard disk alarm settings are correct.

15. Q: Why is the device still in recording status even when I click the **Stop** icon or click **Stop Recording** in the shortcut menu?

A: If you click the **Stop** icon or click **Stop Recording**, only manual recording is stopped. To stop scheduled recording, you need to change the recording status within a certain period of time to not recording. To stop power-on recording, you need to change the recording mode to scheduled recording or manual recording, and then stop recording as described above. Or, you can set the channel status to disabled.

10.2 Use and Maintenance

- 1.To turn off the hard disk recorder, first turn off the system on the software GUI, and then turn off the power supply. Do not turn off the power supply directly to avoid data loss or even damage of the hard disk.
- 2.Ensure that the hard disk recorder is far away from the places with high temperature heat sources.
- 3.Regularly remove the dust deposited inside the device, and keep good ventilation around the case of the hard disk recorder to facilitate heat dissipation.
- 4.Do not hot-plug the audio and video signal cables and interfaces such as RS-232 and RS-485; otherwise, such interfaces may be damaged.
- 5.Regularly check the power cable and data cable inside the device to prevent them from aging.

6. Try to avoid the impact of other electric appliances on audio and video signals, and prevent the hard disk from being damaged by static electricity or induced voltage. If the interface connecting the network cable is frequently plugged in and pulled out, it is recommended that you replace the connection cable regularly to avoid unstable input signals.
7. The device is a Class-A product. In the living environment, the product may cause radio interference. In such cases, practical measures should be taken to cope with the interference.

10.3 Attached Accessories (Subject to the Actual Product)



USB mouse



Power Adapter



Warranty Card

Warning :

Using a wrong battery may increase the risk of explosion.
Used batteries should be handled in accordance with the instructions

CONCORD

www.concordconnect.com.au