

**CONCORD**  
CONNECTING TOGETHER

# DVR Manual

## Contents

SAFETY INSTRUCTION .....	5
CHAPTER 1 PRODUCT OVERVIEW .....	1
1.1 REAR PANEL .....	1
CHAPTER 2 DVR INSTALLATION & CONNECTION .....	2
2.1 HDD INSTALLATION .....	2
2.2 CONNECTION DIAGRAM .....	3
2.3 POWER SUPPLY CONNECTION .....	4
CHAPTER 3 DVR COMMON OPERATIONS .....	4
3.1 USING THE SUPPLIED MOUSE .....	4
3.2 USING THE VIRTUAL KEYBOARD .....	5
3.3 PASSWORD .....	6
CHAPTER 4 DVR STARTING UP .....	8
4.1 START WIZARD .....	8
4.1.1 Start Wizard .....	9
4.1.2 Network Configuration .....	9
4.1.3 Date/Time .....	10
4.1.4 IP Camera .....	11
4.1.5 Disk .....	13
4.1.6 Resolution .....	14
4.1.7 Mobile .....	14
4.1.8 Summary .....	15
4.2 LIVE VIEW SCREEN OVERVIEW .....	15
4.2.1 Camera Quick Toolbar .....	17
4.2.2 Taskbar .....	18
4.2.3 Alarm Popup .....	19
4.2.4 Start Menu .....	19
CHAPTER 5 DVR SYSTEM SETUP .....	21
5.1 CHANNEL .....	21
5.1.1 Channel .....	21
5.1.2 Live .....	24
5.1.3 Image Control .....	26
5.1.4 PTZ .....	30
5.1.5 Privacy Zone .....	37

---

5.1.6 Motion Detection .....	37
5.1.7 PIR .....	38
5.1.8 ROI .....	39
5.2 RECORD .....	40
5.2.1 Encode .....	40
5.2.2 Record .....	43
5.2.3 Capture .....	45
5.3 ALARM .....	47
5.3.1 Motion Detection .....	47
5.3.2 PIR .....	48
5.3.3 I/O Alarm .....	49
5.3.4 Combination Alarm .....	51
5.3.5 PTZ Linkage .....	53
5.3.7 Alarm Schedule .....	55
5.3.8 Voice Prompts .....	55
5.3.9 Deterrence .....	59
5.3.10 Siren .....	61
5.3.11 Alarm Disarm .....	62
5.4 AI .....	64
5.4.1 Setup .....	64
5.4.2 Recognition .....	91
5.4.3 AI Alarm .....	99
5.4.4 Statistics .....	120
5.5 NETWORK .....	123
5.5.1 General .....	123
5.5.2 DDNS (Dynamic Domain name server) .....	126
5.5.3 Email .....	127
5.5.4 IP Filter .....	129
5.5.5 Voice Assistant .....	130
5.5.6 Platform Access .....	145
5.6 STORAGE .....	149
5.6.1 Hard Disk .....	149
5.6.2 Cloud .....	154
5.6.3 FTP .....	158
5.7 SYSTEM CONFIGURATION .....	161
5.7.1 General .....	161
5.7.2 Multi-user .....	168
5.7.3 Maintenance .....	172
5.7.4 IP Camera Maintain .....	179

---

5.7.5 System Information .....	182
<b>CHAPTER 6 AI SCENARIO .....</b>	<b>185</b>
6.1 FACE ATTENDANCE .....	185
6.2 CROSS COUNTING .....	190
6.2.1 Channel .....	190
6.2.2 Group .....	191
6.2.3 Search .....	192
6.2.4 Setup .....	192
6.3 OBJECT CLASSIFICATION .....	194
<b>CHAPTER 7 SEARCH, PLAYBACK &amp; BACKUP .....</b>	<b>196</b>
7.1 USING SEARCH FUNCTION .....	196
7.1.1 Search & Play Video in General .....	198
7.1.2 Event Search, Playback & Backup .....	200
7.1.3 Sub-periods Playback .....	202
7.1.4 Smart Search & Playback .....	204
7.1.5 TAG playback .....	205
7.1.6 External file playback .....	205
7.1.7 Picture Search & View .....	206
7.1.8 Slice Playback .....	209
7.1.9 AI .....	210
<b>CHAPTER 8 REMOTE ACCESS VIA WEB CLIENT .....</b>	<b>218</b>
8.1 BASIC SYSTEM ENVIRONMENT REQUIREMENTS .....	218
8.2 WEB PLUGIN DOWNLOAD AND INSTALLATION .....	219
8.3 WEB CLIENT MANAGER .....	221
8.3.1 Live Interface .....	221
8.3.2 Playback .....	227
8.3.3 Remote Setting .....	232
8.3.4 Local Setting .....	233
<b>CHAPTER 9 VIEWING BACKED UP VIDEO ON PC/MAC .....</b>	<b>233</b>
<b>CHAPTER 10 APPENDIX .....</b>	<b>237</b>
10.1 TROUBLESHOOTING .....	237
10.2 USAGE MAINTENANCE .....	238
10.3 ACCESSORIES (FOR REFERENCE ONLY) .....	239

# SAFETY INSTRUCTION

Please carefully read the following safety instruction so as to avoid personal injuries and prevent the equipment and other connection devices from being damaged.

**1. Power sources (Note: please use the power supply attached or specified by the manufacturer)**

Never operate the equipment by using unspecified power supply.

**2. Never push objects of any kind through openings of DVR**

Never push objects of any kind through openings of DVR so as to avoid electric shock or other accidents.

**3. Do not put the equipment in the dusty field**

Do not put the equipment in the dusty field.

**4. Do not place the equipment under rain or humid environment**

Do not place the equipment under humid environment like basement. If the equipment is accidentally in contact with water, please unplug the power cable and immediately contact your local dealer.

**5. Keep the surface of the equipment clean and dry**

Use soft damp cloth to clean the outer case of DVR (do not use liquid aerosol cleaners)

**6. Do not operate if any problems are found**

If there are any strange smell or sound from DVR, unplug the power cable and contact the authorized dealer or service center.

**7. Do not try to remove the upper cover**

**Warning:** Do not remove the cap of DVR so as to avoid electric shock.

**8. Handle with care**

If DVR does not work normally because of hitting on the hard object, please contact the authorized dealer for repair or replacement.

**9. Use standard lithium battery (Note: Use the batteries attached or specified by the manufacturer)**

After cutting off the power supply, if the system clock cannot continue to work, please replace the standard 3V lithium battery on the main board.

**Warning:** Turn off DVR before replacing the batteries, or you may be suffered from serious electric shock. Please properly dispose of the used batteries.

**10. Put the equipment in a place with good ventilation**

The DVR system includes HDD, which produces large amount of heat during operation. As a result, do not block the ventilation openings (on the top, bottom, both sides and the reverse

side) for cooling the system during operation. Install or put the equipment in the place with good ventilation.

11. The attached power adapter can only be used for 1 set of DVR. Do not connect more equipment, or DVR may be restarted repeatedly because of insufficient power.

12. Prevent the equipment from water dropping or splashing. Do not place objects containing water, such as flower vase, on the equipment.

13. Do not ingest battery, Chemical Burn Hazard.

This product contains a coin / button cell battery.

If the coin / button cell battery is swallowed, it can cause severe internal burns in just 2 hours and can lead to death.

Keep new and used batteries away from children.

If the battery compartment does not close securely, stop using the product and keep it away from children.

If you think batteries might have been swallowed or placed inside any part of the body, seek immediate medical attention.

# Chapter 1 Product Overview

## 1.1 Rear Panel

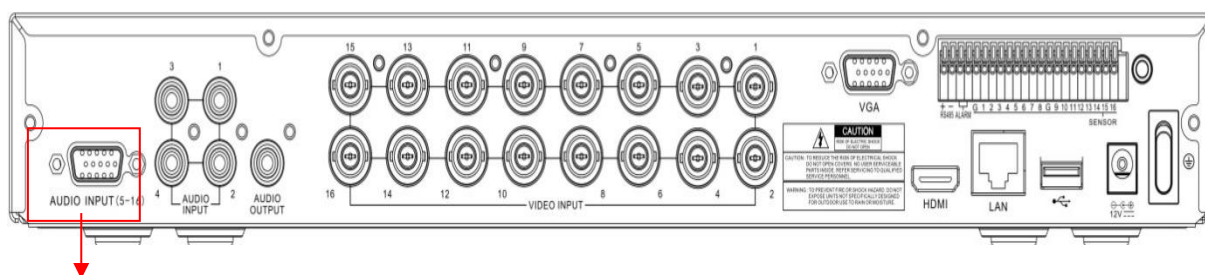
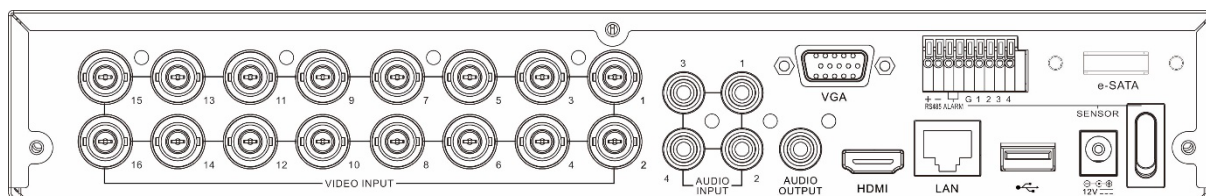

AUDIO INPUT (5-16)

For some models to connect to audio inputs with supplied connector

Item	Description
VIDEO INPUT	Connect with video input devices, standard BNC port
AUDIO INPUT	Connect with audio input signals, RCA port
ADUIO OUTPUT	Audio signal output, RCA port
USB port	Connect the supplied mouse or USB flash memory
VGA	Connect to your TV or a monitor VGA input
Reset	Located under the USB port, press for 10s to restore factory settings
HDMI	Connect to your digital TV port monitor with HDMI input
LAN	Connect to your home network
e-SATA	Optional. Connect to e-SATA HDD for recording & backup
RS-485	Connect to PTZ devices
Sensor & Alarm	Optional. Connect to external sensor & alarm devices
Power	Connect to the supplied power adaptor
Power Switch	Enbale/off power supply

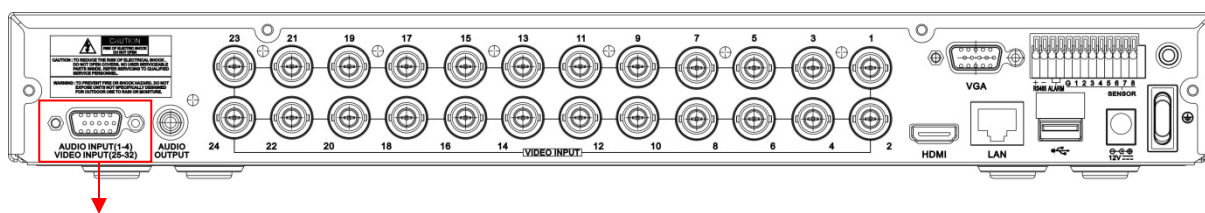

AUDIO INPUT (1-4) & VIDEO INPUT (25-32)

For some 32CH DVR to connect to audio inputs & video inputs (25CH ~ 32CH) with supplied connector

## Chapter 2 DVR Installation & Connection

### 2.1 HDD Installation

Depending on the package you have purchased, the hard disk drive may be included in the full package. If it is not pre-installed, follow the installation instructions on this user manual.

**Caution:** DO NOT install or remove the hard disk drive while the device power is turned ON.

HDD Installation:

- (1) Cut power firstly, and then remove screws on both sides & rear panel, and open DVR upper cover.

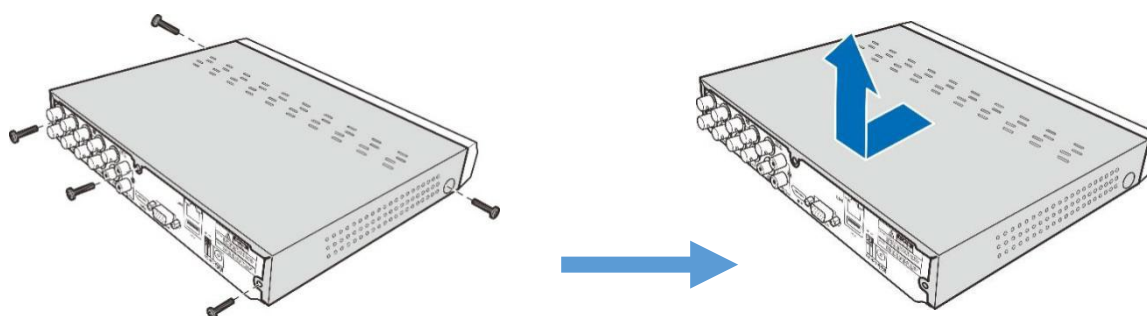

- (2) Connect the data and power cables to the HDD and place the HDD on the DVR case. Carefully flip the DVR case and secure the HDD to the DVR with the screws.

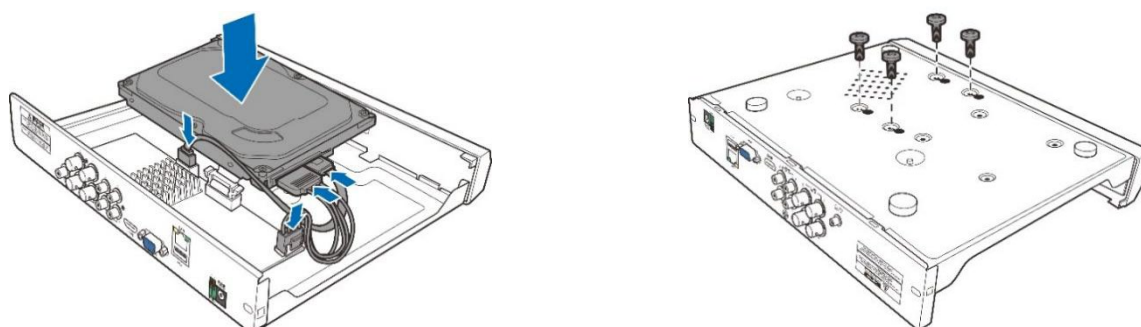



(3) Put the upper cover back carefully, and fix the cover with screws.

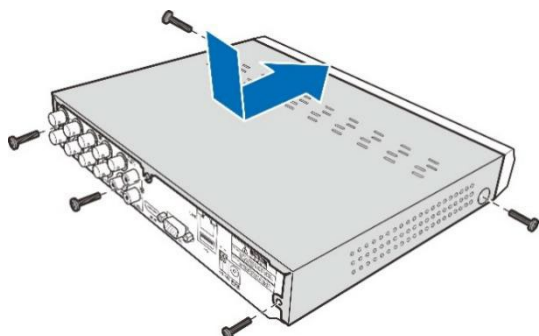

Note: Above procedures are for reference only. The practical operation may be different depending on the DVR you purchased.

## 2.2 Connection Diagram

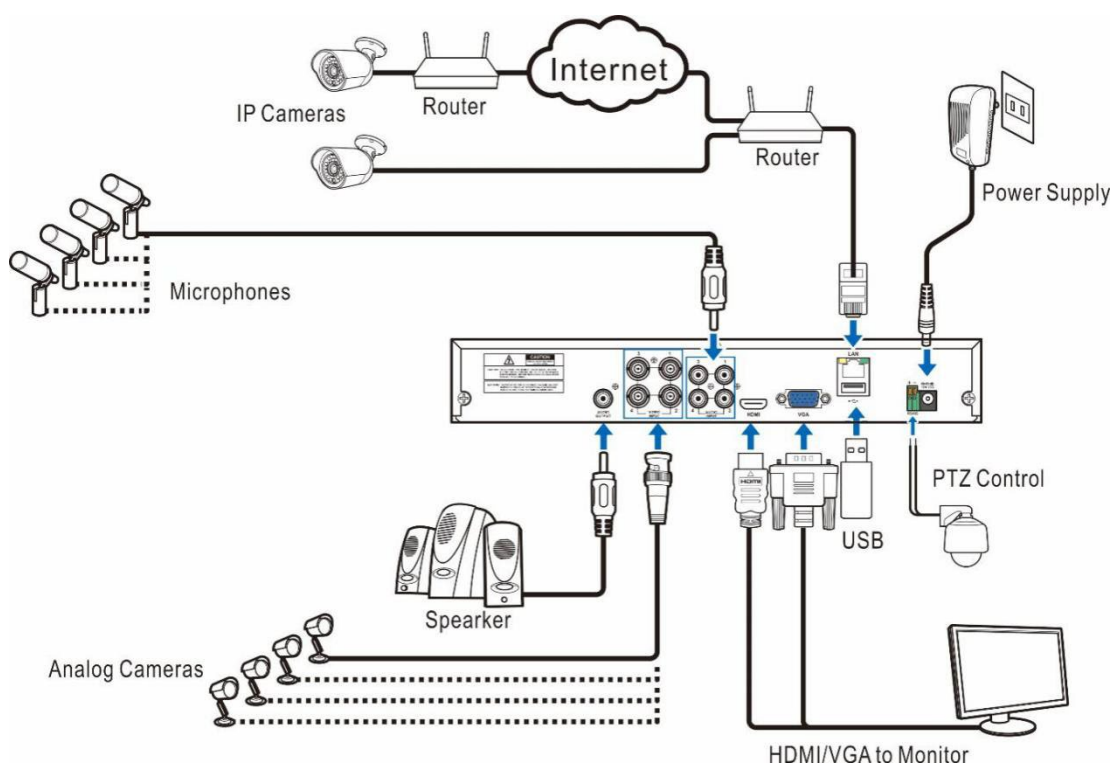

*Note:* Above diagram is for reference only. The practical connection may be different depending on the DVR you purchased.

## 2.3 Power Supply Connection

**Caution:** Use only the supplied power adapter that came with the DVR

Connect one end of the power adapter to the power connector on the back of the DVR. Plug the other end of the power adapter into the wall outlet.

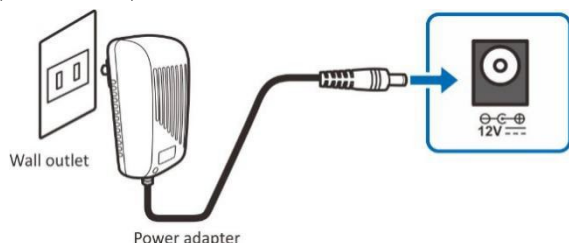

For some specific models, you may need to press the Power switch to turn on the power.

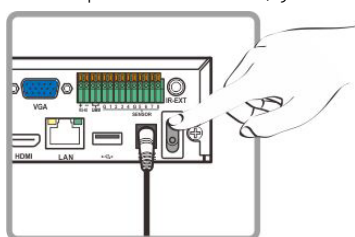

# Chapter 3 DVR Common Operations

## 3.1 Using the Supplied Mouse

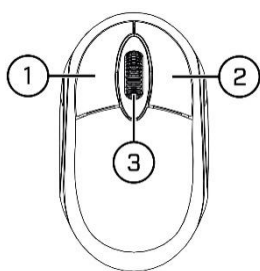

### 1. Left Button

- Click to select menu options.
- During live viewing in split-screen view, double-Click on a channel to view it in full-screen. Double-Click the channel again to return to split-screen viewing.
- Click upon a channel on Live Viewing screen to open Camera Quick Toolbar.
- Click and hold to drag sliders and scales on menu mode

2. Right Button

- Click once to open the Taskbar on the Live Viewing screen. View Taskbar on [4.2.2 Taskbar](#)
- In menus, click to go back / close menus.

3. Scroll Wheel

- In menus, scroll to move up / down through the menu content.
- While hovering over the volume control wheel, scroll to turn system volume up / down.

### 3.2 Using the Virtual Keyboard

You will see the virtual keyboard automatically on the screen when you need to enter data

Click to toggle the keyboard to upper case and more punctuation

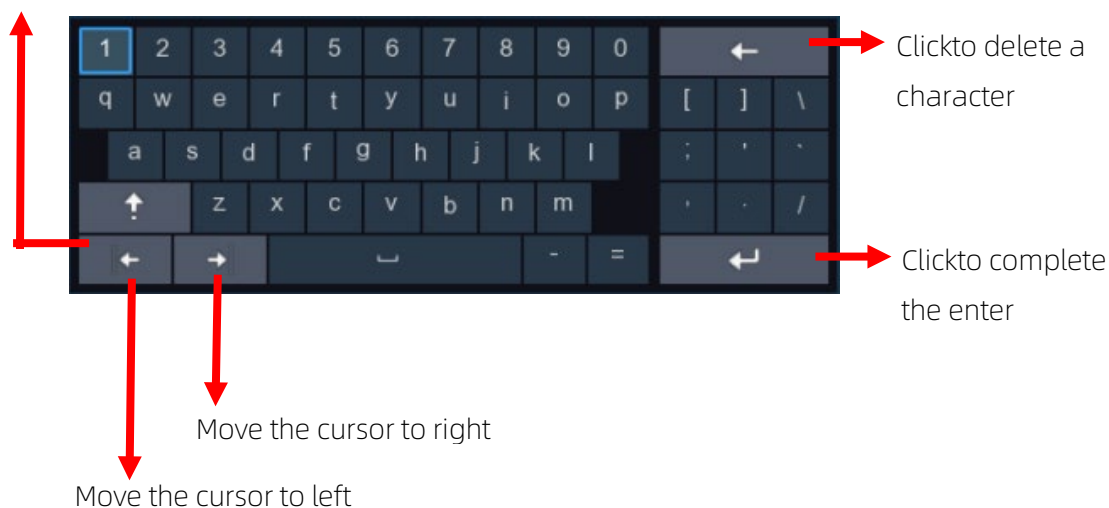

### 3.3 Password

For the first time when you run the DVR, you must be required to set your own password immediately in order to protect your privacy. Please be sure to record your username and password and save them in a secure place.

The screenshot shows a configuration window with the following fields and options:

- Language:** A dropdown menu set to "English".
- Device ID:** A text input field containing "000000" with "(000000)" displayed to its right.
- New Admin Name:** A text input field containing "admin".
- Password Strength:** A progress indicator consisting of three grey bars.
- New Admin Password:** A password input field.
- Confirm Password:** A password input field.
- Unlock Pattern:** A dropdown menu set to "Disable".
- Camera Activation Password:** A password input field with a checkbox labeled "Same as recorder's password" to its right.

An "Apply" button is located at the bottom center of the configuration area.

**Language:** Set the system language, the device supports multi-language setting.

**Device ID:** Enter the device ID in parentheses, the default ID is 000000.

**New Admin Password:** Set the administrator password. The password should be 8 to 16 digits long and must contain at least two combinations of upper case letters, lower case letters, numbers or special characters.

**Confirm Password:** Re-enter the administrator password.

**Unlock Pattern Enable:** Enable the pattern password, draw a pattern and confirm twice to set the pattern password successfully.

The screenshot shows the same configuration window as above, but with a modal dialog box titled "Unlock Pattern" overlaid. The dialog box contains the text "Your unlock pattern has been completed." and a 3x3 grid of circles. A blue line indicates a pattern drawn from the top-left circle to the middle-left circle, then down to the bottom-left circle, and finally right to the bottom-middle and bottom-right circles. A mouse cursor is visible near the bottom-right circle. The "Camera Activation Password" field and its checkbox are partially visible behind the dialog box.

**Camera Activation Password:** This password will be used to activate an unactivated camera that is connected to the DVR. When Same as recorder's password is unchecked, user-defined camera activation passwords are supported. When Same as recorder's password is checked, the device's login password will be automatically applied as the camera activation password.

Click **Apply** to confirm your settings. The system will require to set the password recovery questions in case you forget the password. If you Click the Cancel button without checking any reset method, the password reset function will not be enabled.

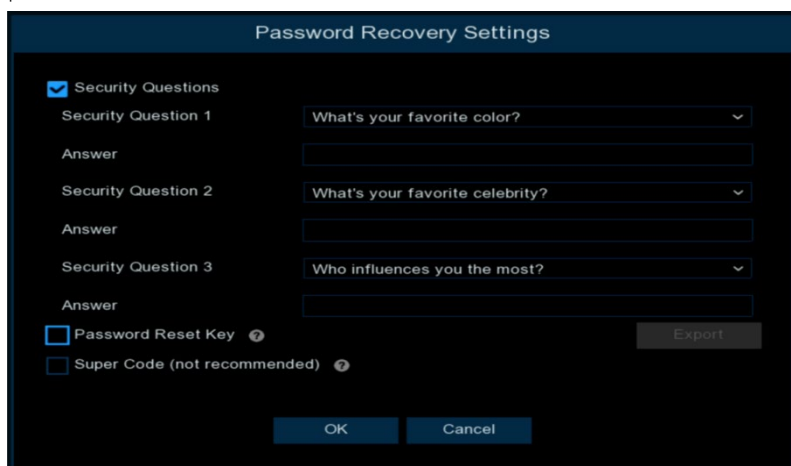

①**Security Question Configuration:** To change the user password by question verification, check the Security Question Configuration, select three questions among 15 questions, and set the answers at a maximum length of 64 characters to retrieve your password.

②**Certificate of authorization:** To change the user password by using a certificate, check the Certificate of authorization, and click Export to download the certificate.txt file.

③**Super code(Not recommended):** This method is to calculate a super code allowing to changing the user password by using the MAC address of the camera and camera time. You are not advised to enable this function as the MAC address of the camera is broadcast over the network, and the system time of the camera can be directly obtained when you log in from the web client and use Super code to change the user password.

Enter the login screen when the system is locked. Enter the device login password and click **Login** to unlock access to the DVR system.

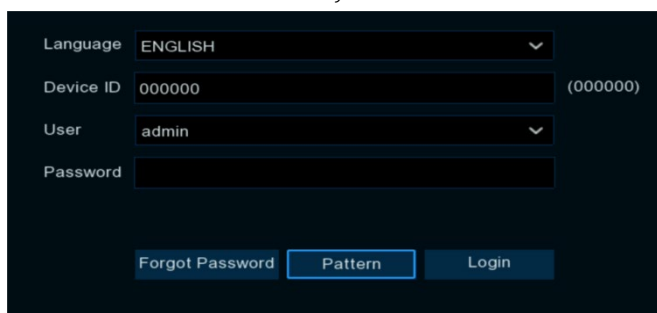

When the system is locked, tap **Pattern** to access the Pattern Password Unlock screen to unlock the device.

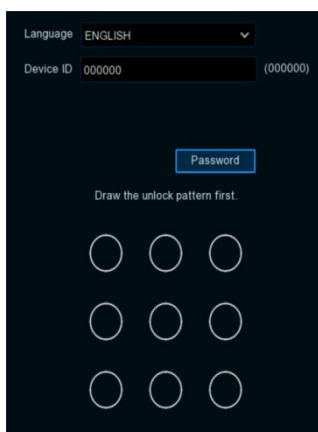

If you forget your password while the system is locked, you can Click [Forgot Password](#) to reset it.

**Note:** The system interface will be locked for 3 minutes after 5 consecutive logins with incorrect passwords.

## Chapter 4 DVR Starting up

### 4.1 Start Wizard

For models that support face recognition function. When you enter the system for the first time, the machine vision face recognition algorithm agreement will pop up. Check "I have read and agree to this agreement" and save it. When the device is connected to an AI camera that supports face recognition, the face recognition function can be enabled. Otherwise, the face recognition function will not be enabled.

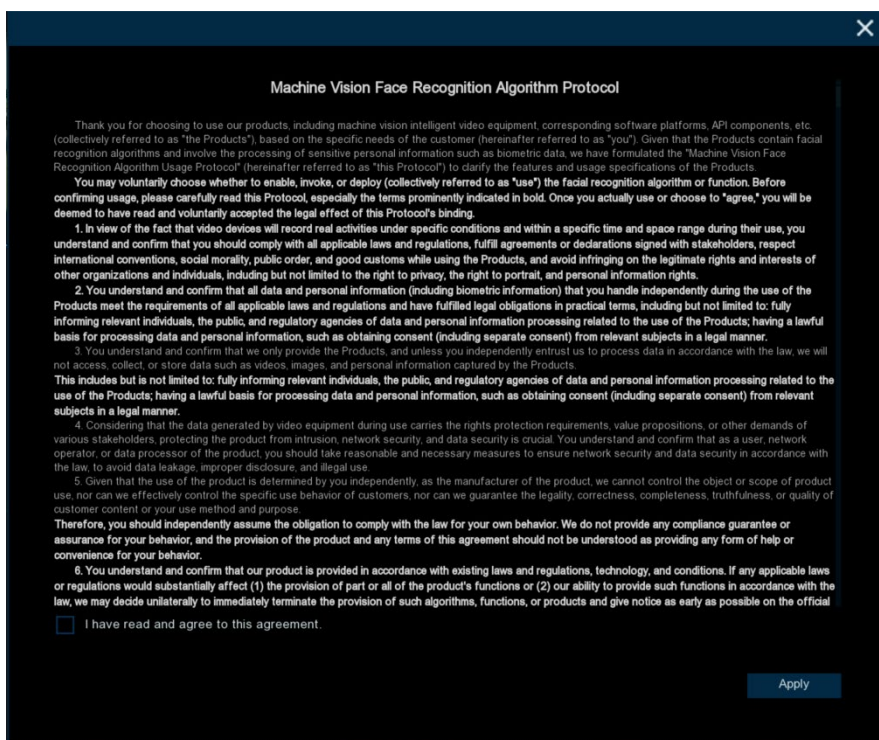

## 4.1.1 Start Wizard

Click the [Start Wizard](#) to proceed to the next step

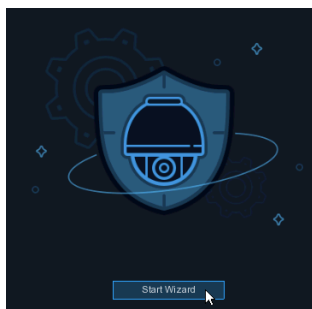

## 4.1.2 Network Configuration

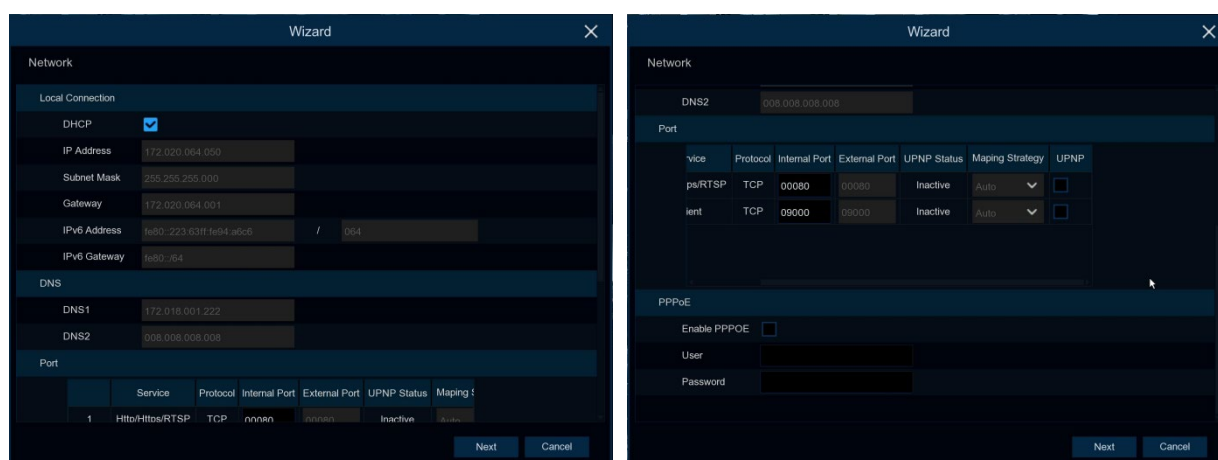

If you connect to a router allows to use DHCP, please check the [DHCP](#) box. The router will assign automatically all the network parameters for your DVR. Unless the network is manually addressed below parameters:

**IP Address:** The IP address identifies the DVR in the network. It consists of four groups of numbers between 0 to 255, separated by periods. For example, "192.168.001.100" .

**Subnet Mask:** Subnet mask is a network parameter which defines a range of IP addresses that can be used in a network. If IP address is like a street where you live then subnet mask is like a neighborhood. The subnet address also consists of four groups of numbers, separated by periods. For example, "255.255.000.000" .

**Gateway:** This address allows the DVR to access the Internet. The format of the **Gateway** address is the same as the **IP Address**. For example, "192.168.001.001" .

**IPv6 Address:** Input the IPv6 address you got from your ISP. It consists of eight groups of numbers between 0 and FFFF separated by colons. For example, "ABCD: EF01: 2345: 6789: ABCD: EF01: 2345: 6789"

**IPv6 Gateway:** IPv6 gateway IP address of the network where the device is located.

**DNS1/DNS2:** DNS1 is the primary DNS server and DNS2 is a backup DNS server. Usually should be enough just to enter the DNS1 server address.

**http/https/rtsp:** This is the port that you will use to log in remotely to the DVR (e.g. using the Web Client), or the DVR will be allowed to transmit real-time streaming to other device (e.g. using a streaming Media player.). The ONVIF is using the same port also.

**UPNP:** If you want to log in remotely to the DVR using Web Client, you need to complete the port forwarding in your router. Enable this option if your router supports the UPNP. In this case, you do not need to configure manually port forwarding on your router. If your router does not support UPNP, make sure the port forwarding is completed manually in your router.

**PPPoE (Point-to-Point Protocol Over Ethernet) :** This is a protocol that allows the DVR to connect to the network directly via a DSL modem.

### 4.1.3 Date/Time

This menu allows you to configure the Date, Time, Date Format, Time Format, Time Zone, NTP and DST.

#### Date and Time

Click on the calendar icon to set the current system date.



**Date:** Click on the  icon to set the system date.

**Time:** Click to set the system time.

**Date Format:** Choose from the drop down menu to set preferred date format.

**Time Format:** Choose time format between 24Hour and 12Hour.

**Time Zone:** Set the correct time zone.

#### NTP

NTP stands for Network Time Protocol. This feature allows you to synchronize the date and time automatically on the DVR over Internet. Therefore, the DVR needs to be connected to the Internet.



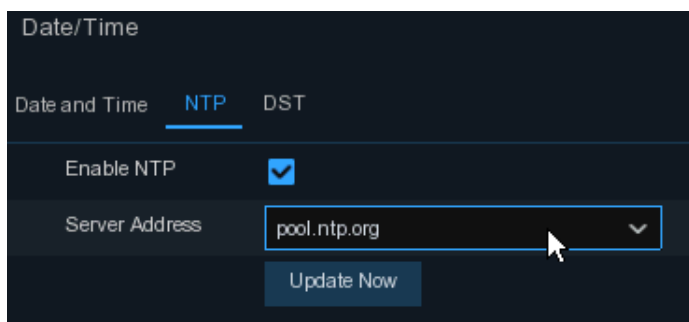

Check the “NTP” box, and select the NTP server.

Note: Default time zone is: GMT. NTP is enabled by default, server address is: pool.ntp.o

## DST

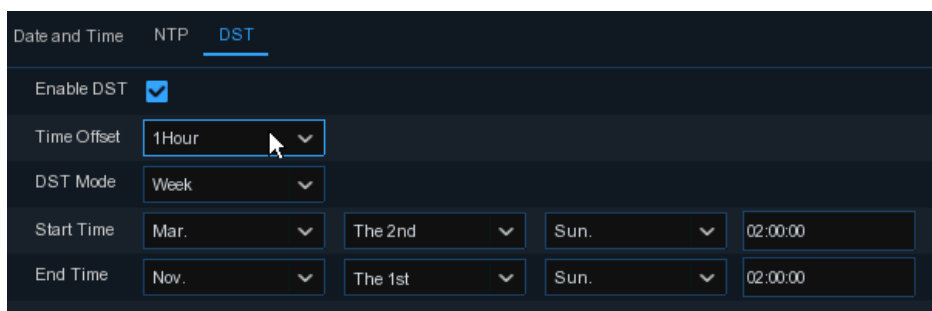

**DST:** Enable if Daylight Saving Time (DST) is observed in your region.

**Time Offset:** Select the amount of time to offset for DST.

**Time Mode:** Choose to set the daylight saving time in weeks or in days.

**Start Time/End Time:** Set the start time and end time for daylight saving.

## 4.1.4 IP Camera

This menu allows you to add IP cameras to the DVR.

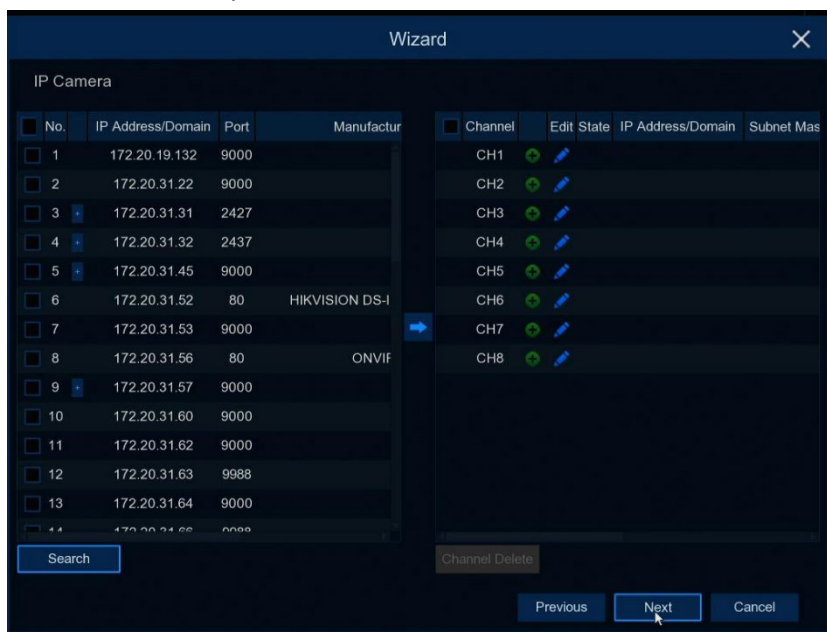

Click [Search](#) to search IP cameras in the same network. Choose the IP camera(s) you want to add, and then click  icon to add to the DVR.

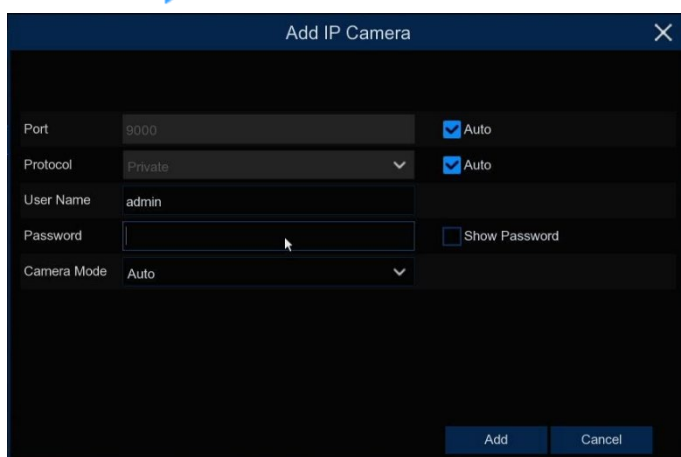

Enter the camera's user name & password to add the camera(s).

You can also Click , Open the IP Camera Add menu and add an IP camera by manually entering information about the camera or by selecting the IP camera from the Device List.

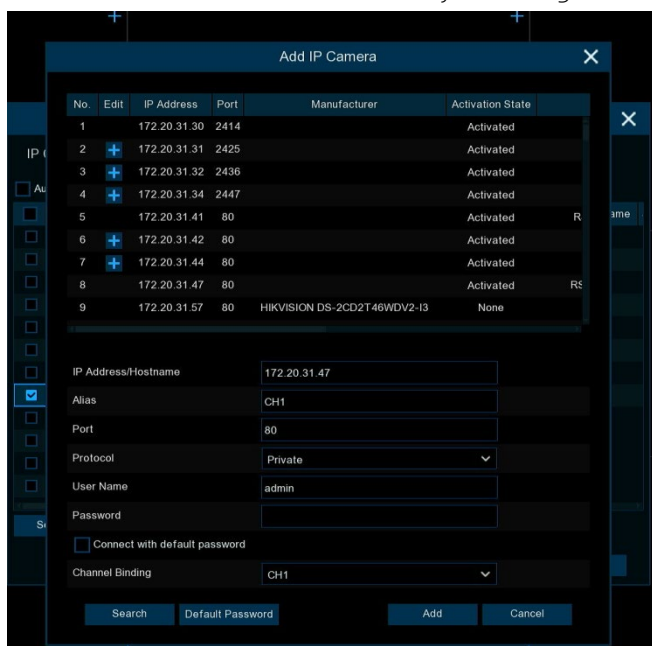

**IP Address/hostname:** IP address or domain name of the IP camera

**Alias:** Name of the IP camera.

**Port:** The port of the IP camera.

**Protocol:** Select the protocol to be used for the add-in

**User Name:** User name of the IP camera

**Password:** Password of the IP camera

**Connect with default password:** When enabled, the camera will connect with the set default password.

**Channel Binding:** select to add to the specified channel

## 4.1.5 Disk

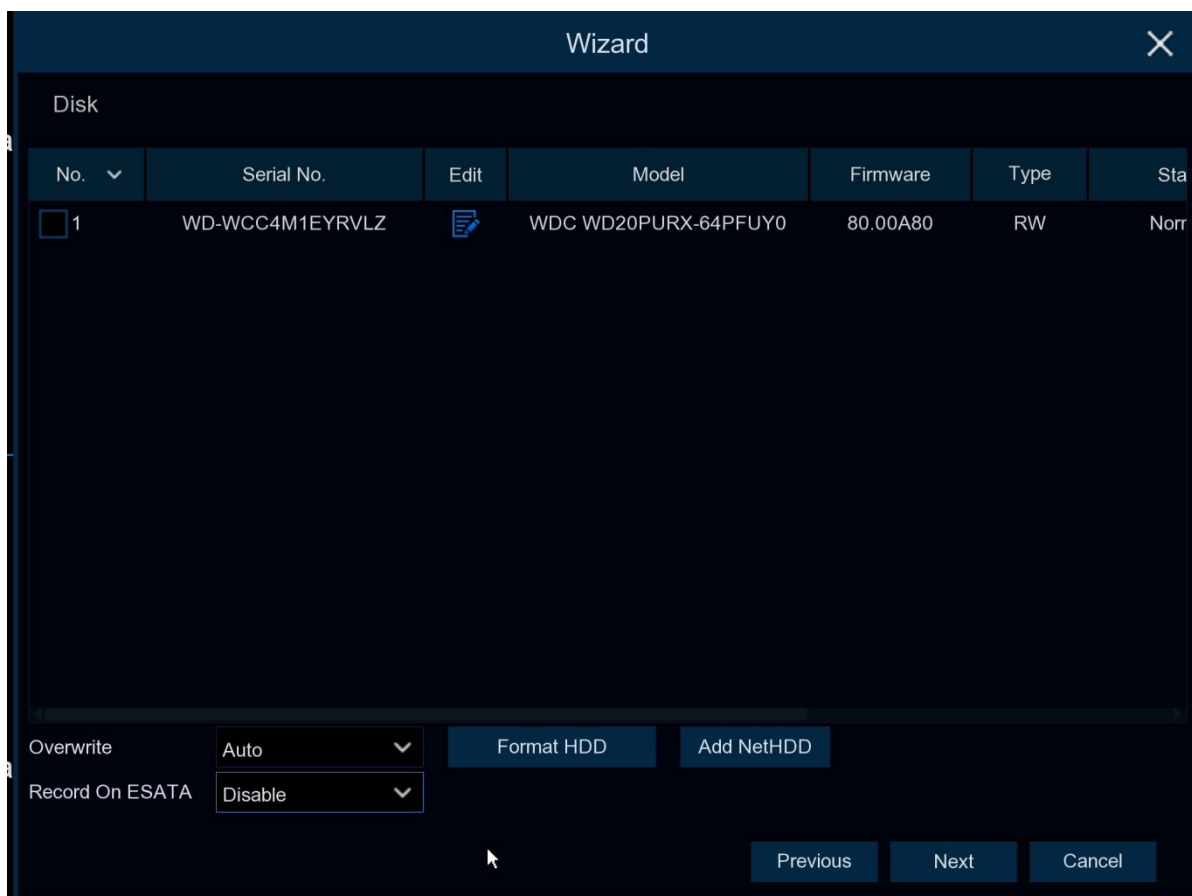

If the HDD is installed in the DVR for the first time, it must be formatted. Select the HDD and then click [Format HDD](#) button to format the HDD.

**Overwrite:** Use this option to overwrite the old recordings on the HDD when the HDD is full. For example, if you choose the option 7 days then only the last 7 days recordings are kept on the HDD. To prevent overwriting any old recordings, select Disable. If you have disabled this function, please check the HDD status regularly, to make sure the HDD is not full.

**Add NetHDD:** Further information please check

**Record On e-SATA:** If your DVR comes with an e-SATA port on the rear panel, you can enable to record the video to e-SATA HDD. This function only available when your e-SATA HDD has been connected to the DVR already.

## 4.1.6 Resolution

Choose an output resolution matches to your monitor. The DVR supports to adjust the output resolution automatically to match the best resolution of your monitor when the system is starting up.

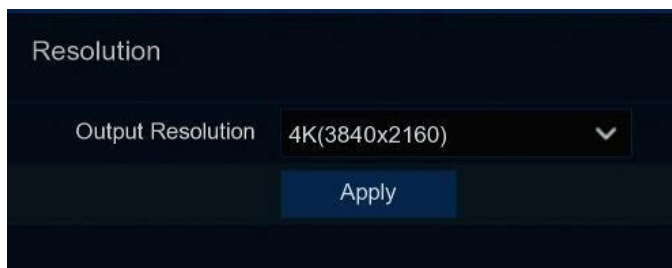

## 4.1.7 Mobile

If your DVR come with a P2P ID, you can scan the QR code with your mobile app to view the DVR remotely.



## 4.1.8 Summary

You can check the system summary information you had set in the start wizard and finish the wizard.

Tick "[Don't show this window next time](#)" if you don't want to display Start Wizard when system reboot next time. Click [Finish](#) button to save & exit.

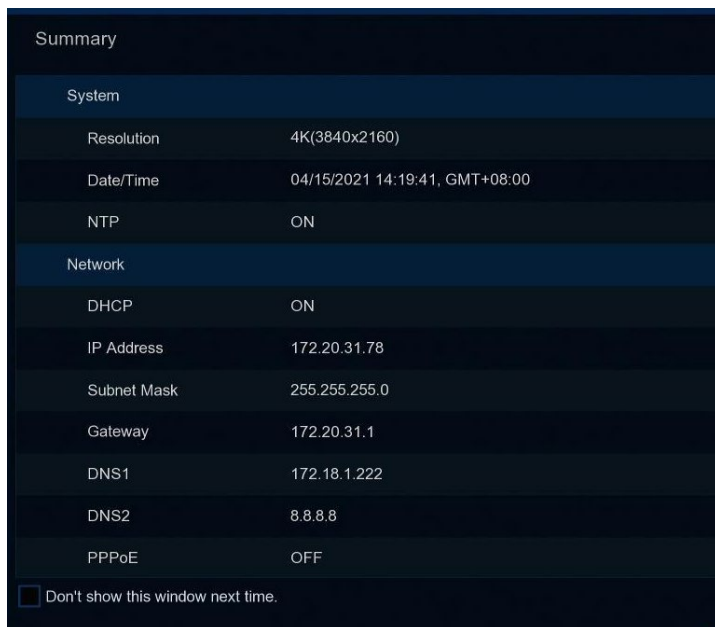

## 4.2 Live View Screen Overview

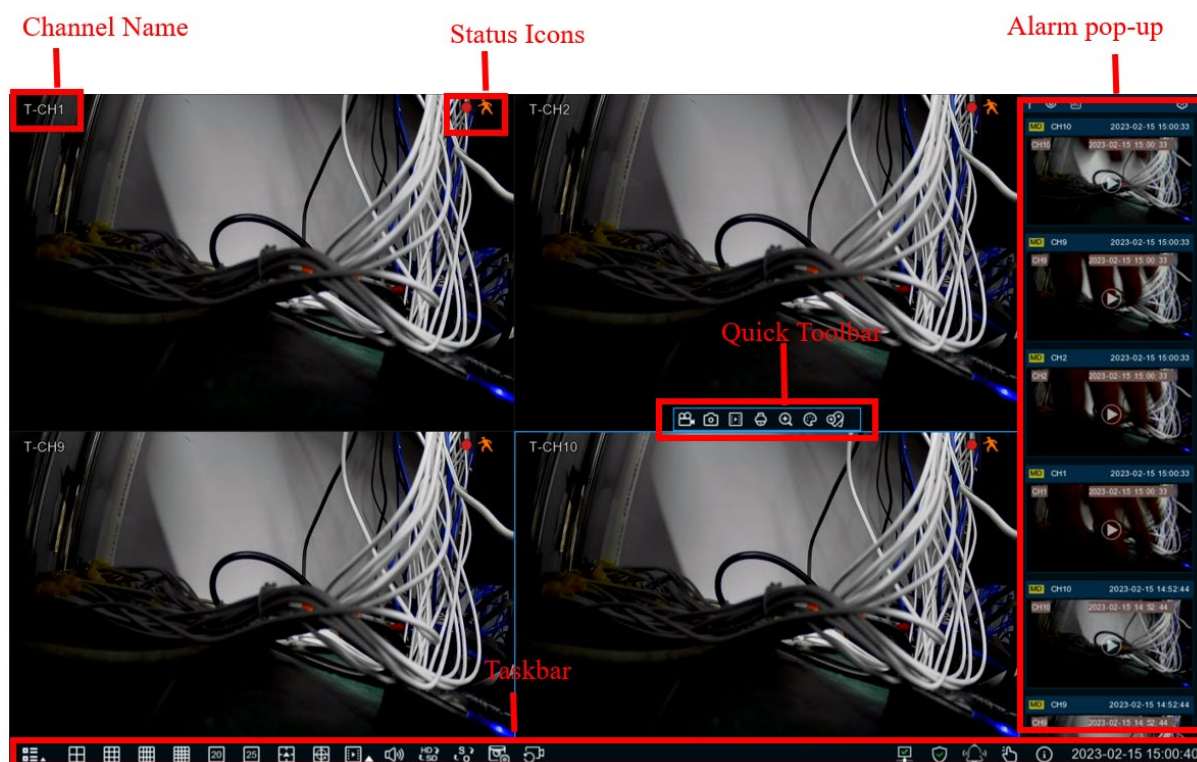

### Camera Title

To display the camera title

**A-:** This indicates that the camera connected is an AHD camera.

**T-:** This indicates that the camera connected is a TVI camera.

**C-:** This indicates that the camera connected is a CVI camera.

**IP:** This indicates that the camera connected is an IP camera.

### State icon

 The camera is being recorded currently

 A motion alarm is happening

 An intelligent or AI alarm is happening

 The external I/O alarm device is being triggered

 The PIR alarm is being triggered

 HDD is uninstalled or in error

 HDD is unformatted

 HDD is full

 HDD is read-only

**Off -line:** The analog camera is disconnected.

**No Camera:** IP camera is disconnected.

**Decoding Failed:** The DVR doesn't support this kind of IP camera compression standard, please change to H.264 compression standard.

**Resource Not Enough:** Insufficient resources, the main code flow does not support all drawings at the same time/MJPEG format can only display one channel.

**Band Not Enough:** Insufficient bandwidth, the channel cannot be online

**Failed to connect to camera:** IPC connection failed

**User name or password error:** IPC username and password are wrong













 Click to open **Quick Add** menu to add IP camera

 Click to edit current IP camera

## 4.2.1 Camera Quick Toolbar

In live viewing, click the left button of your mouse on a connected camera to display the Camera Quick Toolbar.



-  Click to manually record the channel immediately. If the manually recording is in process, the icon will be in red color. Click one more time to stop manual record.
-  Click to save a snapshot of the current camera image. Manual Capture must be enabled to use this feature. For details on enabling Manual Capture.
-  Click to play the latest 5 minutes recording of this channel
-  Click to enter PTZ control panel. Click to control zoom and focus of motorized varifocal lens
-  Click to zoom-in the channel. Scroll the wheel button of your mouse to zoom in and zoom out the image.
-  Click to adjust the image color of the channel.
-  To switch the live view video stream between HD & SD. HD is mainstream images, SD is substream images.
-  If your camera has white light LEDs, click this button to turn on or turn off the LEDs.
-  If your camera has a built-in speaker, click this button to turn on or turn off the alarm sound.
-  If your camera has warning light LEDs, click this button to turn on or turn off the LEDs.
-  Click to start two-way voice communication
-  Tag button. It supports to fast search by adding a tag in live view.
-  AI statistics. Hover the mouse upon the icon to view AI statistics when the AI function is activated in your DVR.

## 4.2.2 Taskbar

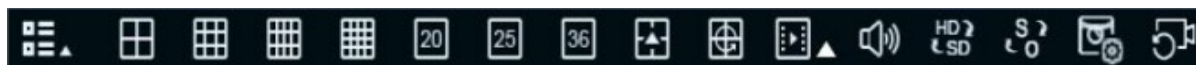

 Click to pop up the Start Menu

 Click to display 4/9/12/16 channels in live view screen

 Click to choose more display layouts in live view screen

 Click to start viewing channels in a sequence.

 Quick playback. Playback all channels from the beginning of the day, you can also Click on the triangle at the bottom right to choose to playback from the last 5s, 10s, 30s, 1Min, 5Min.

 Click to adjust audio output volume

 Click to switch the live view image resolution for all channels between mainstream and substream.

 Click to switch the image scale for all channels between original and stretch.

 Click to switch among real-time, balanced, or smooth view. It affects the live view video quality by changing the bitrate and frame rate.

 Click this button to restore the scrambled channel positions.



: Network is disconnected.

: Network is connected but offline.

: Network is well connected.

 DVR in Arming state.

 DVR in Disarm state.

 Manually turn on/off all channels white light and siren.

 Manually turn on/off channels recording and IO alarm.

 To view system information, channel information, record info and network state.





 The device is connected through USB\_ WIFI and is recognized successfully. It can access the Internet through WiFi.

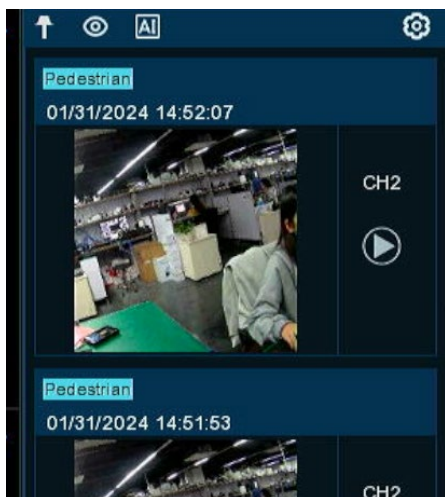

### 4.2.3 Alarm Popup

The Alarm Notification Panel displays thumbnails of alarm events that have occurred. Events are color-coded according to the event type. Use the mouse scroll wheel to scroll up and down (place the mouse cursor over the notification panel first). Click the play button next to or over the thumbnail to play the event.



1. Click  to display the notification panel at all times.
2. Click  to hide the notification panel.
3. Click  to reveal AI statistics information.
4. Click  to reveal the Filter and Statistics functions (shown below).

Use the Filter function to customize which alerts and which camera will appear in the notification panel. You can also customize the time duration and channels you want to display in AI statistics.

### 4.2.4 Start Menu

With the start menu, you can switch user, search & playback, enter system setup menu, lock & unlock the screen, shut down, reboot & logout the system.

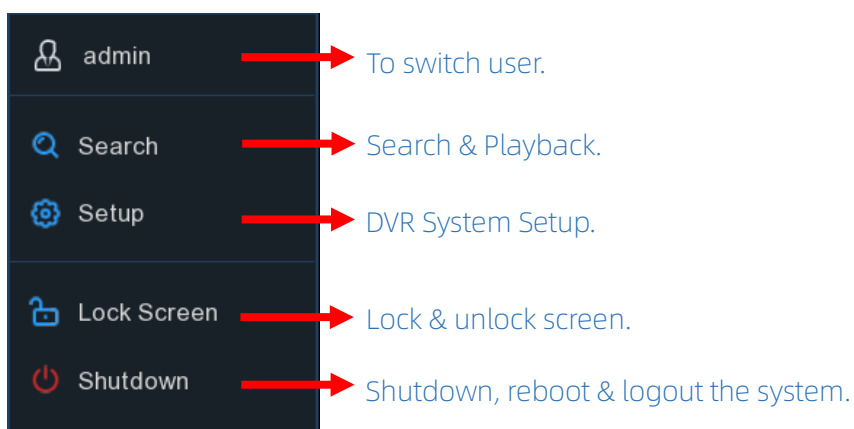

### 4.2.4.1 Unlock and Lock Screen

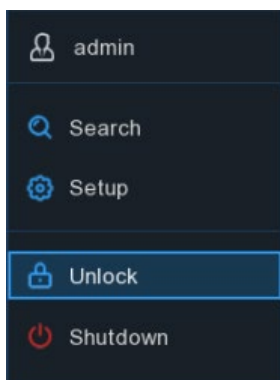

When the DVR is out of menu operation for an extended period of time, the screen is locked to secure the system.

If necessary, you can also lock the screen operation manually. To do so, go to Star Menu, and then click the Lock Screen icon  to lock the system immediately.

If the system is locked, you can click the Unlock icon  to unlock the system for further operation.

### 4.2.4.2 Shutdown

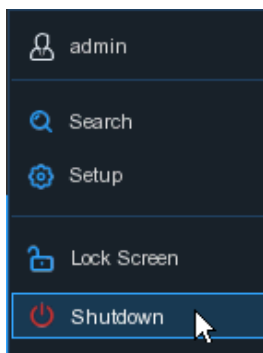

Click the **Shutdown** button from Star Menu, and then check the further action you want to move. Click **OK** button, system will require to input the Admin password to authenticate.

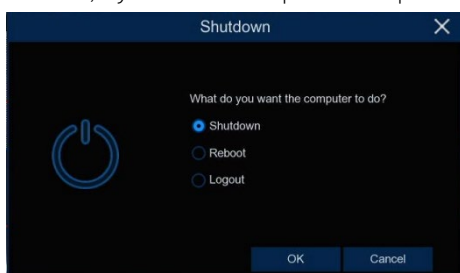

If you choose **Logout** the system, the live viewing screen will be disappeared. You will need to login the system for further operations.

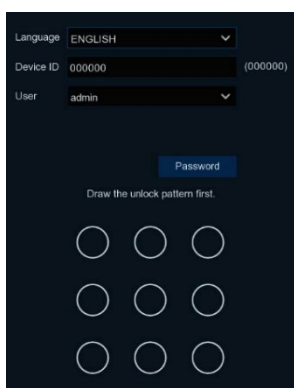

# Chapter 5 DVR System Setup

You are able to configure the DVR for Channel, Record, Alarm, Network, Device & System from [Start Menu](#) → [Setup](#).

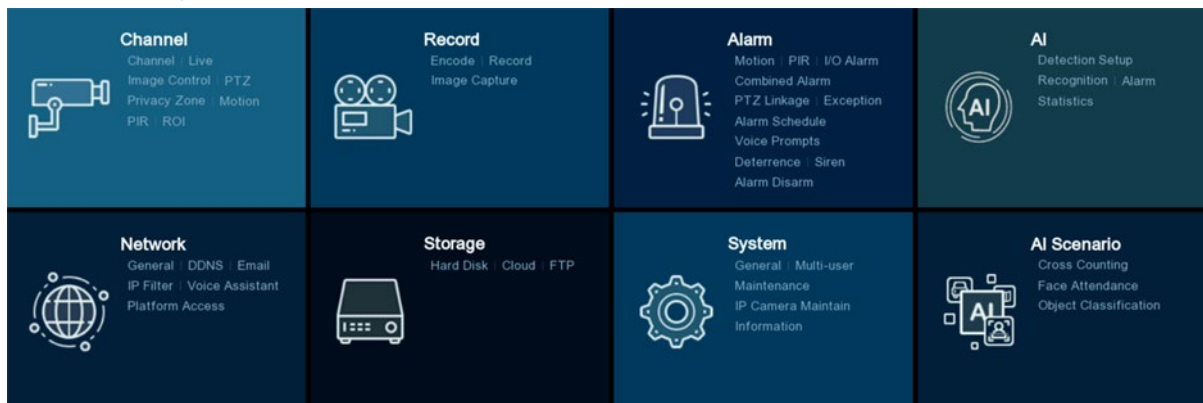

## 5.1 Channel

In this section, you are allowed to configure the camera, live view display, manage IP cameras, adjust IP camera’s image, PTZ setup, motion setup, convert mode and more.

### 5.1.1 Channel

#### 5.1.1.1 Channel configure

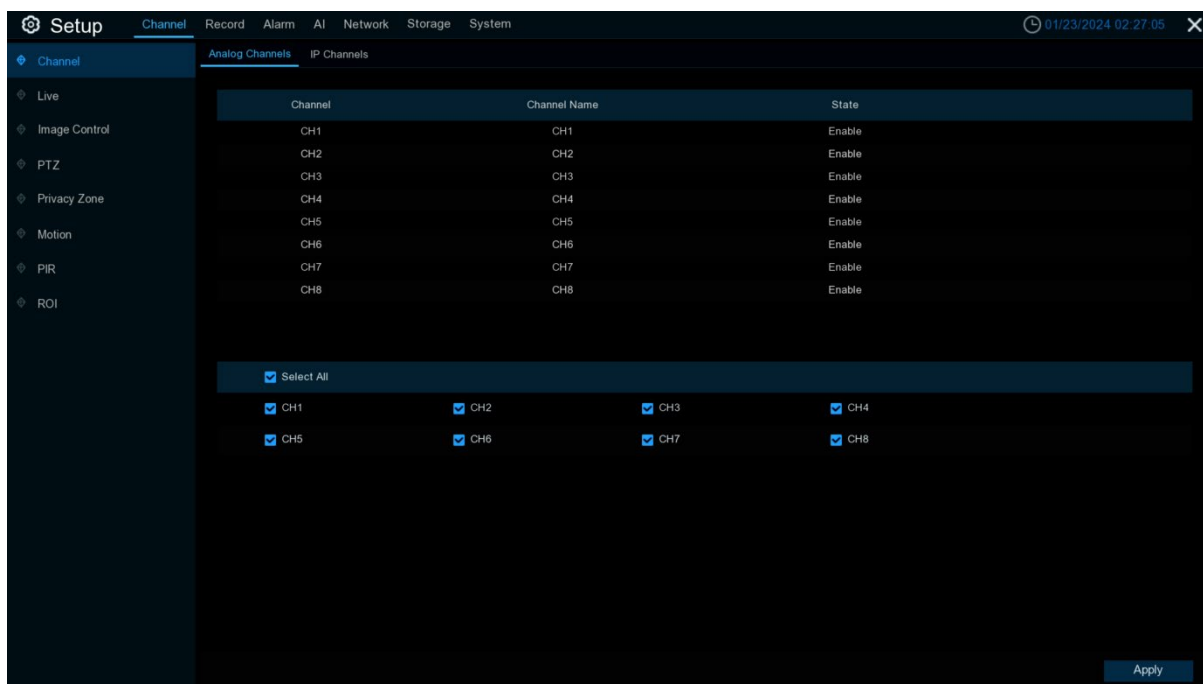

The DVR supports to disable analog channels to increase IP channels. If you want to disable an analog channel, uncheck the box and click [Apply](#) to save. To disable an analog channel can increase an IP channel input.

### 5.1.1.2 IP Channels

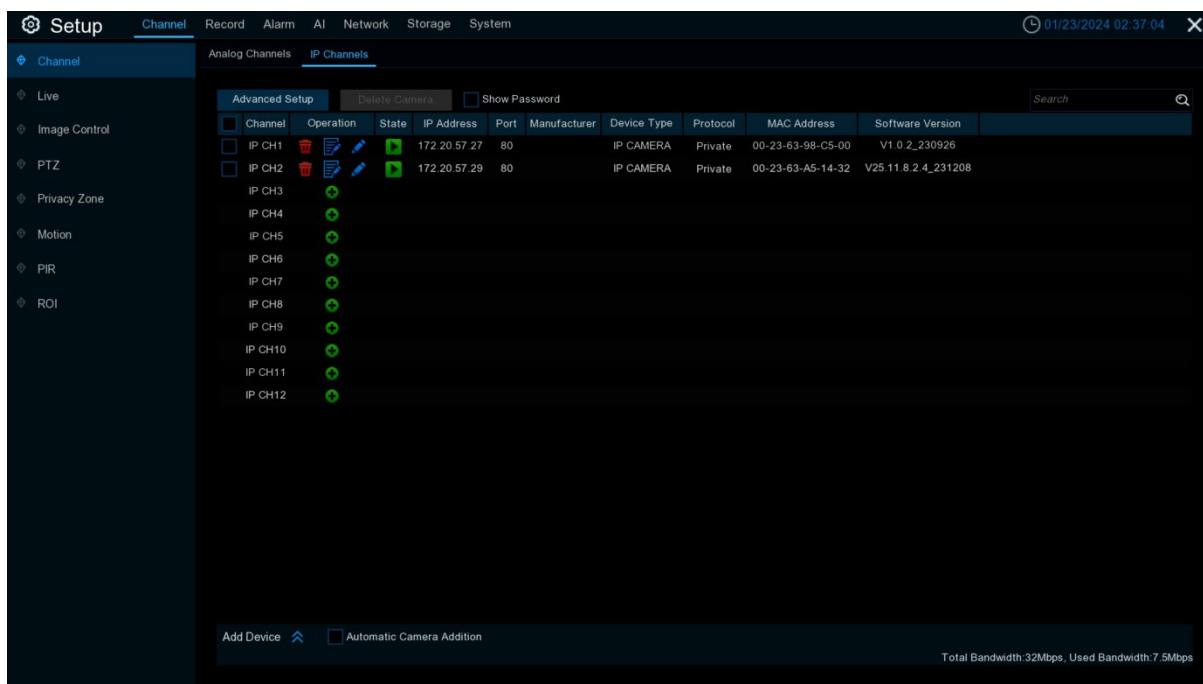

1. Click **Add Device** to expand and collapse the device search window.
  - a. Click **Search** button to search and display the devices under the same LAN. Based on the search result, select one or more devices, and click **Add** to enter the corresponding information to complete the addition.
  - b. Based on the search result, you can select multiple devices, click **Batch IP Modification**, set the correct information, you can batch IP modification for the selected cameras.
  - c. Check **Automatic Camera Addition**, the device will automatically add cameras to the channels where cameras are not added.

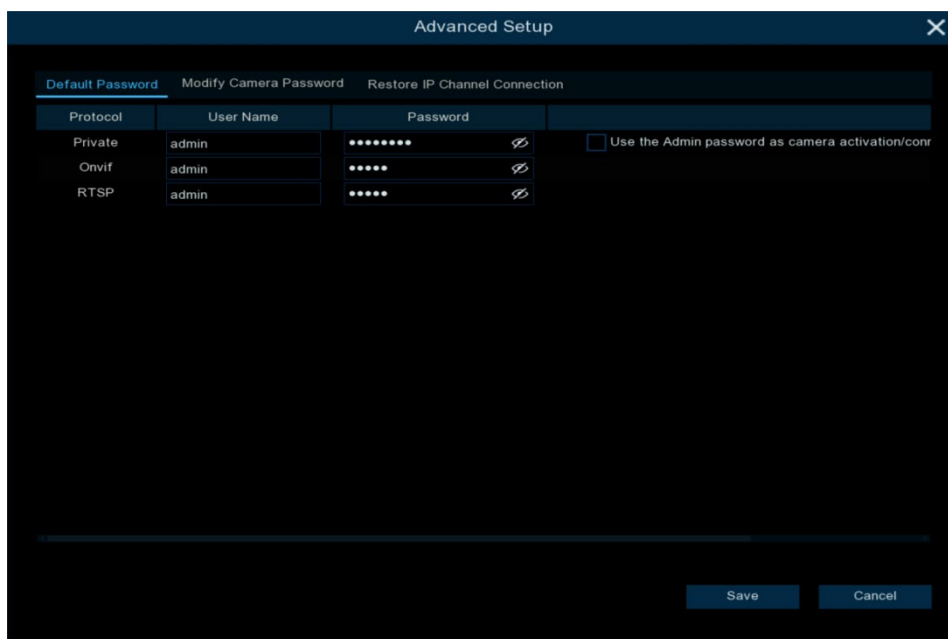

2. Click the **Advanced Setup** button to enter the device's password to open the Advanced Setup page, where you can do the following:

a. **Default Password:** Set the default password for the device to connect to the camera via Private/Onvif/RTSP protocol. The default password for the Private protocol can be used to activate the connected camera that is not activated. When **Use the Admin password as camera activation/connection password** is checked, the Private protocol will use the device administrator password for activation/connection of the accessed camera.

b. **Modify Camera Password:** You can modify the password of the online camera.

c. **Restore IP Channel Connection:** When the device forgets the password and resets the password by restoring the factory settings. You can Click Restore IP Channel Connection to restore the channel connection parameters before restoring the factory settings, and add the original online camera with one Click .

3. Select the camera that has been added to the device, click Delete Camera button to delete the camera.

4. Check **Show Password**, enter the device password to verify that the camera has been added to the device connection password can be displayed

Click the **Search** icon Search to search for online cameras on your LAN, select the camera you want to add and enter the correct information to add it.

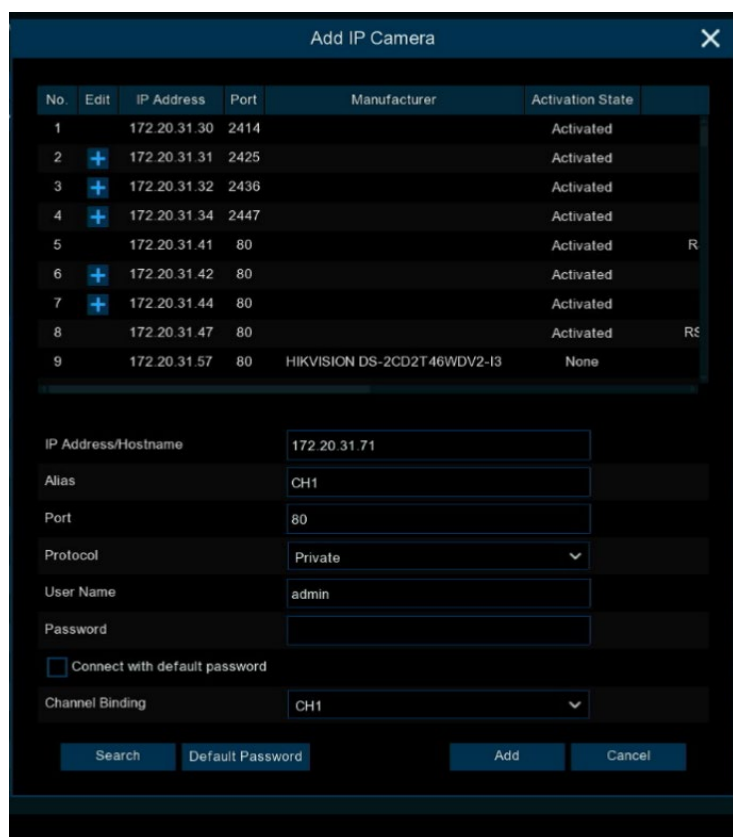

**Alias:** The name of the IP camera.

**Protocol:** Select the protocol of the IP camera from the drop-down menu, there are private, onvif and RTSP protocols.

IP Address/Hostname: 172.20.57.36

Alias: IP CH3

Port: 9988

Protocol: Private

User Name: Private

Password: RTSP

Connect with default password

Channel Binding: IP CH3

Buttons: Search, Default Password, Add, Cancel

**Connect Mode:** This item will be displayed when you select the onvif protocol, select **General** or **Security** from the drop down menu. Selecting **General** will use the http port to connect to onvif. selecting **Security** will use the https port to connect to onvif.

Note: If the camera does not support the https method, it will automatically switch to the http port.

**Mainstream URL:** When selecting the RTSP protocol, this item will appear and you will have to enter the address of the main stream to which you want to connect the IPC.

**Substream URL:** When the RTSP protocol is selected, this item appears and you have to enter the address of the substream to which you want to connect the IPC.

Click the Mode drop-down box to select auto or ePoE mode.

## 5.1.2 Live

To configure camera parameters.

Channel	Setup	Hide Preview	Channel Name	Show Name	Date Format	Time Format	Show Time	Refresh Rate	Camera Type
CH1		<input type="checkbox"/>	CH1	<input checked="" type="checkbox"/>			<input checked="" type="checkbox"/>		AUTO
CH2		<input type="checkbox"/>	CH2	<input checked="" type="checkbox"/>			<input checked="" type="checkbox"/>		AUTO
CH3		<input type="checkbox"/>	CH3	<input checked="" type="checkbox"/>			<input checked="" type="checkbox"/>		AUTO
CH4		<input type="checkbox"/>	CH4	<input checked="" type="checkbox"/>			<input checked="" type="checkbox"/>		AUTO
IP CH1		<input type="checkbox"/>	Camera	<input checked="" type="checkbox"/>	YYYYMMDD	24 Hour	<input checked="" type="checkbox"/>	60Hz	

Buttons: Copy, Default, Apply

**Channel:** Display channel name.

**Hide Preview:** The current channel hide the live image in local UI.

**Setup:** Click icon into the setup page.

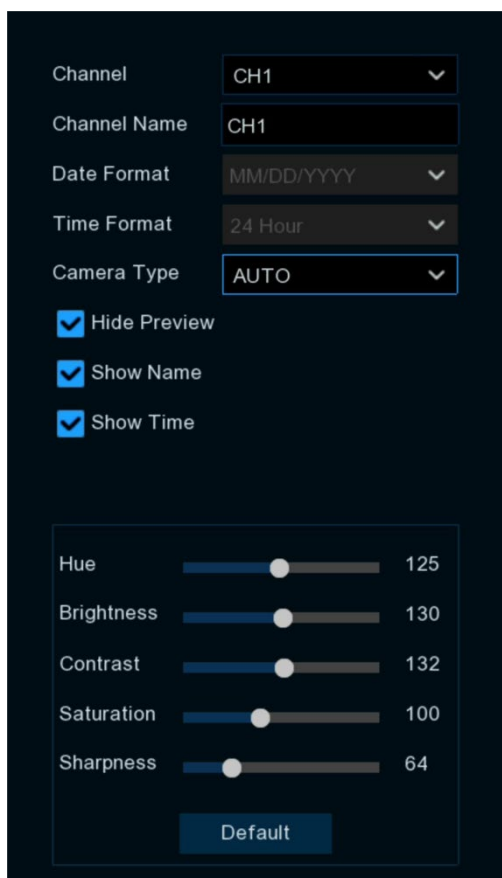

**Channel Name:** Set the channel name.

**Date Format:** Set the date format displayed by the OSD of the IP camera.

**Time Format:** Set the time format displayed by the OSD of the IP camera.

**Camera type:** Switch the analogue camera type.

**Refresh Rate:** Set the refresh rate of the IP camera.

**Hide Preview:** Check the box to hide the preview of the channel.

**Show Name:** Preview the camera channel name.

**Show Time:** Preview the camera time.

**Auto Text Color:** Set the IP camera to change the OSD font colour according to the background of the screen to ensure a clear display.

**Brightness:** Adjusts the image brightness.

**Contrast:** Adjust the image contrast.

**Saturation:** Adjust image saturation.

**Sharpness:** Adjust image sharpness

**Default:** Restore the default values of the image parameters.

### 5.1.3 Image Control

This menu allows you to control image settings for supported IP cameras.

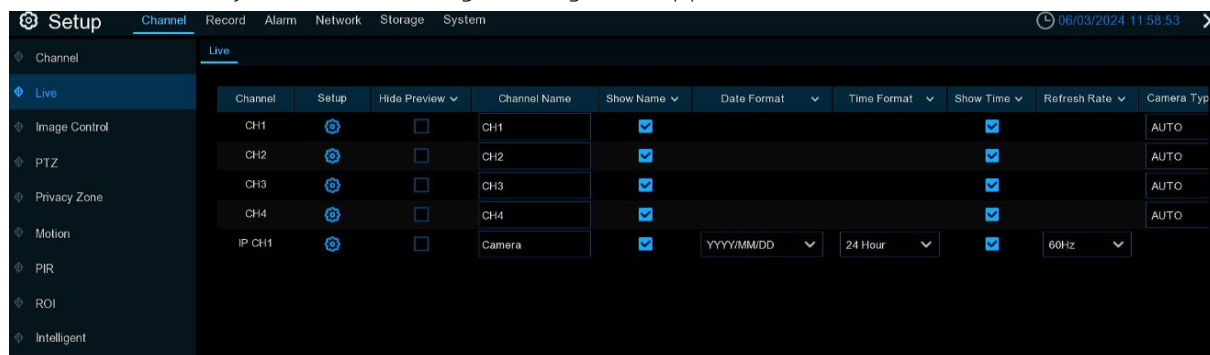

**Channel:** Channel name.

**Setup:** Click icon into the setup page.

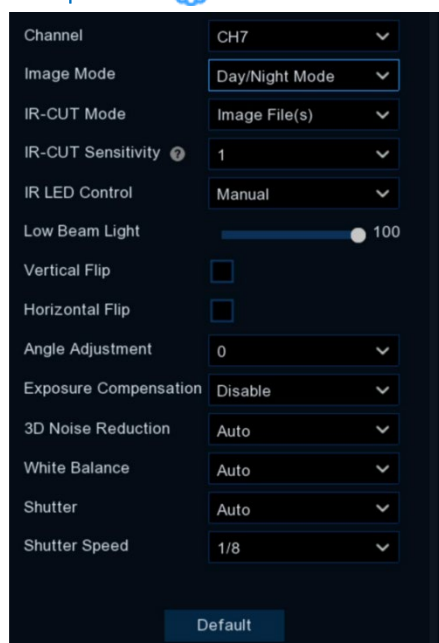

**Channel:** Choose a channel to configure.

**Image Mode:** Lets you choose how the camera handles color and how it manages the transition from daytime to night-time and vice versa:

**Full Color Mode:** The camera works in Full Color Mode.Fill light comes on when ambient illumination is low.

**Day/Night Mode:** The camera works in Day/Night Mode.When the ambient illumination is insufficient, the infrared lamp lights up to replenish light. when the ambient illumination is sufficient, the infrared lamp goes out to end the replenishment.

**Smart Illumination:** In this mode, the camera in night mode when the alarm is triggered will be linked to the warm light to fill the light.The image turns into color. Alarm end the camera back to night mode.

**White Light:** Used to set the fill-in light for the white light in Full Color Mode. There are four mode options.



**Automatic mode:** In Automatic Mode, the camera automatically adjusts the intensity of the fill-in light according to ambient illumination.

**Manual:** In Manual Mode, the fill-in light is applied on the environment with a fixed brightness value.

**Schedule:** In Schedule Mode, the white light is automatically switched on and off for fill-in as scheduled.

**OFF:** Used to turn off the white light.

**Sensitivity:** Sensitivity 0-3. The degree to which the camera is sensitive to ambient light. The higher the value is, the higher the sensitivity is.

**Light Distance:** Ranging from 0 to 100 and used to adjust the brightness of the fill-in light. The higher the value is, the higher the brightness is.

**IR-CUT Mode:** Used to set the day/night switching mode of the camera in Day/Night Mode. There are five mode options.

**Auto/GPIO Auto:** Used to automatically control the Switching mode. Among them, color to b/w is judged by images and b/w to color is judged by light sensitivity to ambient light.

**Day/Color Mode:** Forced Color mode will not be switched to B/W.

Night/Black White Mode: Forced B/W mode will not be switched to color.

**Image File(s)/Image Control:** Similar to the Auto Mode, color to black and black to color are judged by images (for non-photosensitive models).

**Schedule/B/W Schedule:** Used to switch between b/w and color as scheduled. If this function is enabled, the start time and end time for night vision shall be set.

**IR-LED Control:** Used to set the fill-in light effect of the IR light at night vision. There are three mode options.

**SmartIR:** Used to intelligently control the fill-in light intensity of the IR light according to focal length and overexposure condition.

**Manual:** Manual Mode in which the fill-in light is applied in the form of the set brightness of the IR light.

**OFF:** No fill-in light is applied for any light.

**Low Beam Light:** Here you can manually adjust the brightness of the first set of IR lamps (0 to 100, of which 0 indicates that the IR light is off and 100 indicates the highest brightness).

**High Beam Light:** Here you can manually adjust the brightness of the second group (camera support required) of IR lamps (0 to 100, of which 0 indicates that the IR light is off and 100 indicates the highest brightness).

**Vertical Flip:** Invert the image up and down

**Horizontal Flip:** Invert image orientation horizontally

**Corridor Mode:** This allows you to make better use of the camera's vertical angle for an optimized view of long, narrow scenes. Enable this if your camera is viewing a narrow corridor.

**Angle Trad:** Setting the flip angle

**Exposure Compensation:** Set exposure compensation, there are 4 modes

**WDR:** Wide dynamic range in which the picture is uniformly balanced based on the setting and both light and dark areas can be clearly distinguished. (DWDR here for some models)

**HLC:** Highlight compensation in which the objects in the highlighted area are clearer in the picture. (applicable for some models).

**Back Light:** Backlight compensation in which the objects in the dark area are more clearer.

**Disable:** An image will not be optimized with backlight on.

**3D Noise Reduction:** Used to reduce the noise in the image so as to make the image clearer. There are three mode options.

**Automatic mode:** In this mode, the camera automatically selects the noise reduction effect in accordance with algorithms.

**OFF:** The noise reduction function is disabled.

**Manual:** In this mode, image noise is reduced in accordance with the noise reduction coefficient manually configured.

**White Balance:** Used to set white balance. There are two mode options.

**Automatic mode:** In this mode, the white light is adjusted by the default parameters.

**Manual:** In this mode, you can manually set the synthetic gained white light of red, green, and blue.

**Shutter:** Used to set the shutter exposure time. There are two mode options.

**Automatic mode:** In this mode, a proper exposure time is automatically selected in accordance with the configured Time Exposure value.

**Manual:** In this mode, the configured Time Exposure value is used.

**Time Exposure:** Used to set the exposure time of the camera. This parameter is used together with the Shutter parameter.

**AGC:** Used to set Automatic Gain Control (AGC). It is supported by some models.

**Defog Mode:** Used to set defog mode to optimize the display effect in foggy days. There are three mode options.

**OFF:** The defog function is disabled.

**Automatic mode:** In this mode, the camera automatically judges the defog effect.

**Manual:** In this mode, defogging is performed in accordance with the manually configured value.

**Default:** Click this button to restore the default image parameter setting.

**Thermal channel image control ( need to connect a thermal camera )**



**2D Noise Reduction:** Reduce the noise in the thermal channel screen according to the manually set noise reduction parameters, the larger the parameter value, the more obvious the noise reduction effect and the clearer the image screen.

**3D Noise Reduction:** Reduce the noise in the thermal channel according to the manually set noise reduction parameters, the larger the parameter value, the more obvious the noise reduction effect and the clearer the image.

**Detail Enhancement:** Enhance the detail performance effect in the thermal channel screen according to the manually set parameters, the larger the parameter value, the more obvious the enhancement effect and the clearer the image screen.

**Palette:** Set the color pseudo-color mode of the thermal imaging channel, which indicates the difference in temperature by different colors.

**Fusion:** You can choose whether or not to fuse the optical channel screen to the thermal imaging channel screen.

**Normal:** The optical channel screen and the thermal imaging channel screen are not fused and are displayed independently.

**Details Overlay:** Fuses the optical channel screen to the thermal channel screen, so that the thermal channel screen shows more details of the optical image.

**Image Fusion Ratio:** The ratio of the optical channel image to the thermal imaging channel image. The larger the value of the parameter, the larger the ratio of the optical channel image, and the closer the fused image effect is to the optical channel image effect. On the contrary, the smaller the parameter value is, the closer the fused image effect is to the image effect of the thermal imaging channel before fusion.

**Edge Fusion Ratio:** The larger the value of the parameter, the clearer the fused image will be. On the contrary, the blurrier it will be.

**Fusion Distance:** the distance between the optical channel and the thermal imaging channel.

**Horizontal trim:** Horizontal trim, adjust the horizontal position of the optical channel screen relative to the thermal imaging channel screen in the fusion screen.

**Vertical trim:** Adjusts the vertical position of the optical channel image relative to the thermal imaging channel image in the fusion screen.

**Background Correction:** Optimizes the effect of the thermal imaging channel image. Set up a uniform temperature barrier in front of the lens. For example, a uniform foam or cardboard that completely blocks the thermal imaging lens. The device optimizes the image once using the uniform blocker as a criterion.

**Shutter Correction:** Optimize the thermal imaging channel image screen effect.

## 5.1.4 PTZ

This menu allows you to configure the PTZ (Pan-Tilt-Zoom) settings for the dome camera.

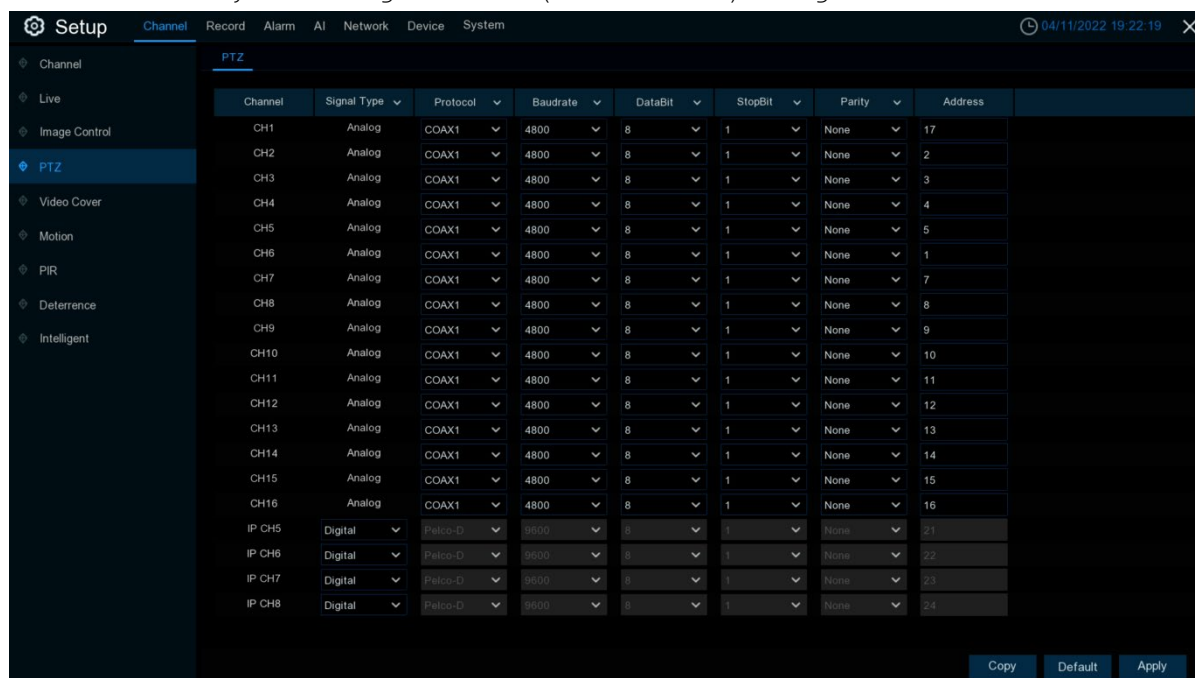

**Channel:** Channel name

**Signal Type:** Analog for analog channels, Analog & Digital for IP channels.

**Protocol:** Choose the communication protocol between the PTZ capable camera and DVR. If your camera support UTC (Up the Coax) function, you can choose COAX1 or COAX2 to display your camera OSD menu or control the UTC PTZ function.

**Baudrate:** The speed of the information sent from the DVR to the PTZ-capable camera. Make sure it matches the compatibility level of your PTZ-capable camera.

**DataBit / StopBit:** The information between the DVR and PTZ-capable camera is sent in individual packages. The **DataBit** indicates the number of bits sent, while the **EndBit** indicates the end of the

package and the beginning of the next (information) package. The available parameters for **DataBit** are 8, 7, 6, 5. the available parameters for the **StopBit** are 1 or 2.

**Parity:** For error check. See the documentation of your PTZ-capable camera, to configure this setting.

**Cruise:** Enable to use the cruise mode. In order to use the cruise mode, you need to set a number of preset points.

**Address:** Set the command address of the PTZ system. Please be noted that each PTZ-capable camera needs a unique address to function properly

#### **Focus mode**

**Auto:** Focus automatically according to the scene change.

**Semi-auto:** Focusing once after operating the camera or zoom to get a clear focus. It will not refocus even if the scene changes. The default value is semi-auto.

**Manual:** Users focus manually through the preview interface focus button, operating the gimbal, zoom and scene changes do not trigger the focus action.

**Zoom Status:** In the lower left corner of the preview screen, it will show the magnification of the dome lens. You can choose whether or not to display it or how long to display it.

**Pan & Tilt Status:** In the lower left corner of the preview screen, the horizontal and vertical azimuth of the camera will be displayed. You can choose whether or not to display it or how long to display it.

**Preset Status:** In the lower left corner of the preview screen, it will show the number of the preset point called by the ballbar. You can choose whether or not to display it or how long to display it.

**Min.Focus Distance:** when the distance from the scene object to the lens is less than the minimum focus distance, the lens will not change the focus of the object. Priority will be given to objects larger than the "Min.Focus Distance" parameter. For example, when the minimum focus distance is set to 6m. You can set up a blocking plate at 1.5m to block part of the lens field of view, half of which is the distant view and half of which is the near view. The camera will prioritize focusing on the distant view after 6m

### **5.1.4.1 PTZ control**

After completing the PTZ settings, you can use the PTZ function to control the high-speed dome camera. Click the left mouse button in the live preview channel, and in the toolbar at the bottom of the channel, click the icon to enter the PTZ control panel.

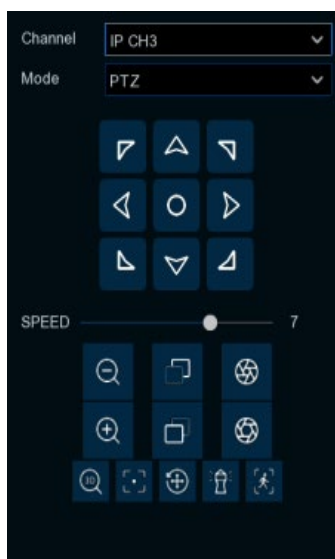





**Channel:** Select Channel

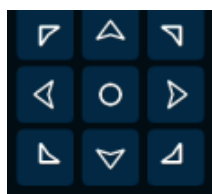

**Mode:** PTZ, PRESET, Line Scan, Watch Mode, Tour, Pattern Scan.



**SPEED:** head speed adjustment crossbar, divided into 1-10 gears, the larger the value of the faster the speed of rotation



Long press the direction button can control the head to rotate horizontally, vertically and other directions. Click the  button in the center, the PTZ will continue to rotate horizontally, at this time the button will change to sky blue color. Click it again to stop rotating.

 and : Indicates "Zoom In -" and "Zoom Out +". When holding down the "

 and : Indicates "Focus -" and "Focus +". In manual focus mode, press and hold down the "

 and : Indicates "IRIS -" and "IRIS +". When the monitor screen is relatively dark, you can press and hold "

 Enable/disables 3D positioning. Click it to turn on 3D positioning, the button pattern turns blue when it is turned on. when the button is Click ed once more, 3D positioning will be stopped.

When the system turns on the 3D positioning function, you can do the following operations:

1. Use the left mouse button to Click on a certain place in the preview screen, then the smart ball will move the corresponding point to the center of the video.

2. Press and hold the left button to pull out a rectangular area to the right and down (up), then the smart ball will move its center to the center of the video and zoom in.

3. Press and hold the left button to pull out a rectangular area to the upper left (lower), then the smart ball will move its center to the center of the video and zoom out.

 Assisted Focus, click this button and the smart dome will perform auto focus.

 One key reset, click this button, the smart ball will clear the preset points and cruise path.

 One-key watch, click to execute one-key watch once, this function depends on the model, please refer to the actual interface.

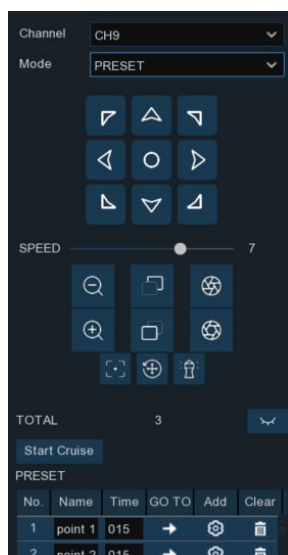

 Manual tracking, turn on/off manual tracking function, when Pedestrian & Vehicle is off, this button is grayed out.

Select **PRESET** mode.



Click  to display the preset point screen below the preview screen, as shown below.



1. Operate the arrow keys of the PTZ control to turn the PTZ to the orientation that needs to be saved, click  or  in the above figure to add a preset point. The preset point screen is displayed at the bottom of the preview screen. On the left side, the preset points will be displayed. The preset points that have been set are displayed in dark color. Unset preset points are displayed in gray.

2. Click  will rotate to the position set by the preset point and take the shortest path.

3. Click on the Name box to modify the name of the preset point, and click on the Time box to modify the time to stay at that preset point while cruising.

4. Click  to delete the preset point.

5. Click Start Cruise to start cruising.

Note: It supports to add up to 255 preset points.

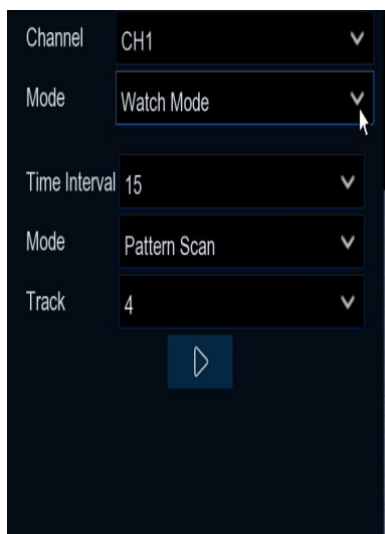

**Watch Mode :** When the PTZ turns on the watch function and no control signal comes after the set watch waiting time, the ball head will automatically execute the preset action.

**Time Interval:** watch position waiting time, the interval between stopping the operation and continuing the watch position action.



**Mode:** Select the watchman mode, default cruise, preset point, linear scan, track cruise, pattern scan.

Click  to start the cruise.

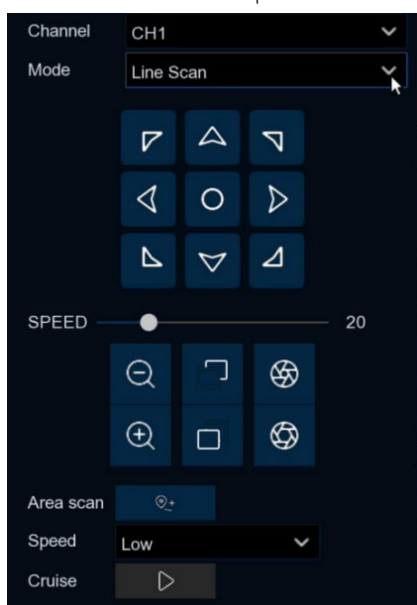
**Note:** Only one watch point can exist at the same time. Click on the Invoke Default Cruise button will cause the device to perform an uninterrupted 360° uniform counterclockwise rotation



**Line Scan:** The camera will implement the Line Scan function.

**Area scan:** Click  to record the start position, rotate the ball camera and click  to record the end position.

**Speed:** Select the linear cruise speed.





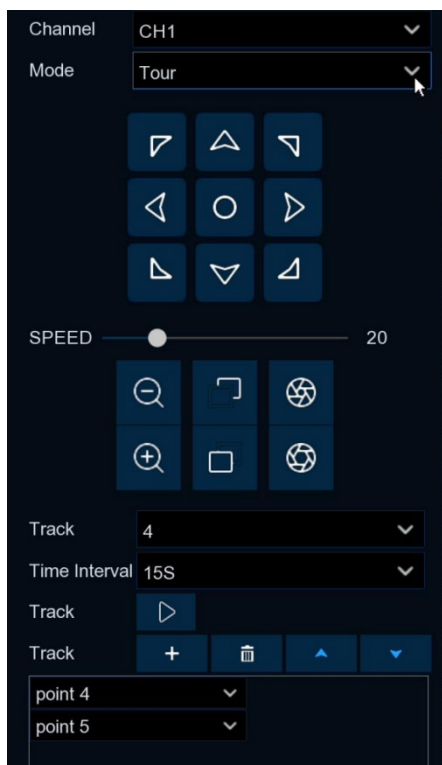

Click  Start Linear Cruise, the device will cruise at a constant speed between the start position and the end position.



**Tour Page:** Cruise according to the set track, 4 tracks can be set at the same time, and 32 preset points can be selected for each track.

**Time Interval:** Dwell time of each preset point.

Click  Add preset point, click  to delete preset point, click  /  to move up/down preset point.

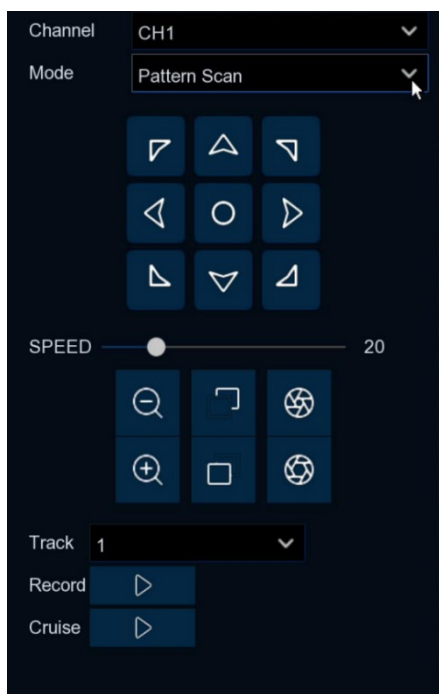

Click  to start cruising, the device will cruise in the order of the added preset bits.

Note: After adding preset points, you need to Click the cruise button to save the track path.



**Pattern Scan:** Pattern scanning means scanning according to preset path. recording the horizontal and vertical movements of the gimbal, the zoom operation and other actions. after recording and saving, you can directly call up the pattern scanning route. After recording and saving, the pattern scanning route can be called up directly. The gimbal supports 4 pattern scanning paths and provides saving options for each pattern scanning path.

Track: select a track

**Record:** Click  to start recording the cruise route and perform any PTZ operation on the device. Click  to stop recording.

**Cruise:** Click  to start cruising the previously recorded route and maneuvers.

### 5.1.4.2 PTZ Schedule (need PTZ support the feature)

Click the "Scheduled Tasks" tab to set the PTZ task schedule. The setting interface is shown in the figure below. Users can set the PTZ to automatically perform different cruise tasks in different time periods.

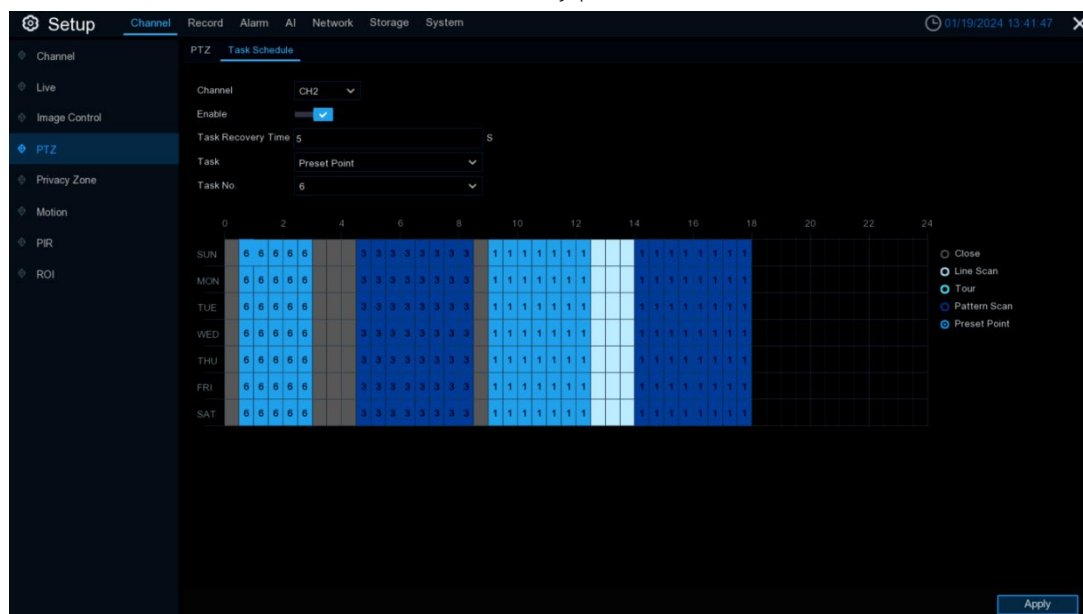

**Enable:** Enable/disable the PTZ task schedule function. If the number of times the PTZ cruises reaches the limit, there will be a corresponding prompt on the right side of the switch.

**Tasks Recovery Times:** Tasks Recovery Times. When the PTZ is executing tasks according to the schedule, manual operation interrupts the cruising task. After the task recovery time, the ballbar will automatically resume the corresponding cruise task of the schedule.

**Tasks Type:** The schedule task types of the PTZ are Off, Linear Scan, Track Cruise, Pattern Scan and Preset Point. Among them, 4 different paths can be set for Track Cruise and Pattern Scan, and the preset point task can set preset point numbered from 1 to 8.

**Note:** The priority of the task schedule will be higher than the priority of the watch mode.

## 5.1.5 Privacy Zone

This function can obscure all or part of your image for privacy (you can create up to 4 privacy masks per camera). Areas obscured by a mask won't be shown live or recorded.

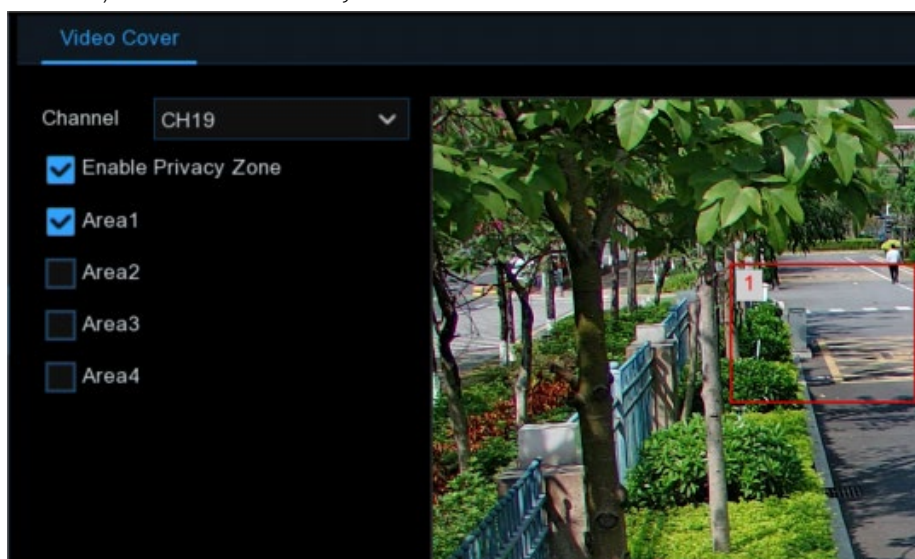

**Channel:** Select a camera that you would like to edit.

**Enable Privacy Zone:** Tick to enable this function.

**Area :** You can set up to four private areas in the screen, all 4 areas can be moved and stretched, click Apply to save and take effect.

Note: After setting the privacy area, the screen covered by the privacy area will not be visible in preview and playback.

## 5.1.6 Motion Detection

Users can configure the parameters related to motion detection on this page. When the camera detects a moving target in the frame, the DVR will trigger the motion detection alarm.

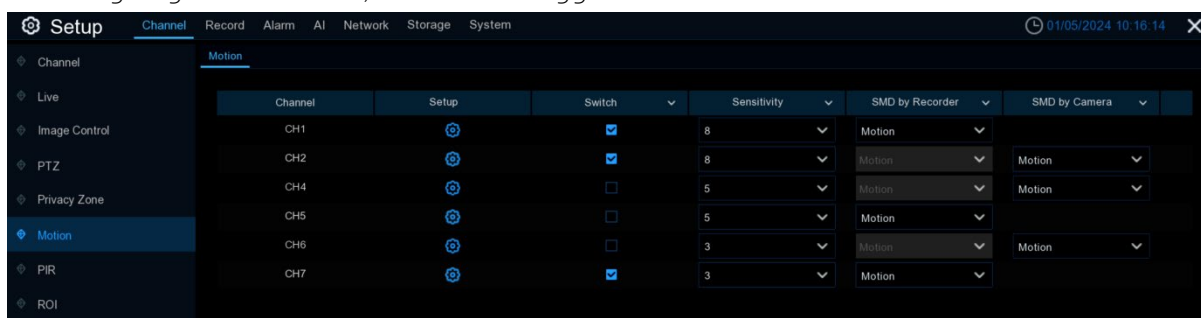

**Switch:** Enable or disable motion detection.

**Sensitivity:** This option allows you to change the sensitivity level. The higher the number, the more sensitive your DVR will be when detecting motion.

**SMD by Recorder:** Used for the cameras that do not support intelligent motion detection. with Motion, Pedestrian, Vehicle, Vehicle&Pedestrian 4 detection types to choose from.

**SMD by Camera:** Used for the IP cameras that support intelligent motion detection. with Motion, Pedestrian, Vehicle, Vehicle&Pedestrian 4 detection types to choose from.

(Note: Some models of IP cameras support this function. The SMD by Recorder function will be grayed out and unavailable after connecting to this model of IP camera.)

Click  icon into the setup page.



**Motion Detection Area:**

Click **Select All** to set the entire screen of the camera as motion detection detection area.

Click **Clear All** to clear the entire area.

If you want to edit the size of the area, check the box and change the position.

When the settings are complete, click the right mouse button to return and then click **Apply** to make the area settings effective.

Back to the main interface, click "Alarm" button to configure the motion detection alarm function.

### 5.1.7 PIR

This menu allows you to configure PIR (passive infrared motion detector) parameters. When PIR alarm has been detected by one or more cameras, your DVR will alert to you a potential threat. It does this by sending you an email alert with an attached image from the camera to use as a reference (if this option is enabled) and/or sending push notifications via the mobile app.

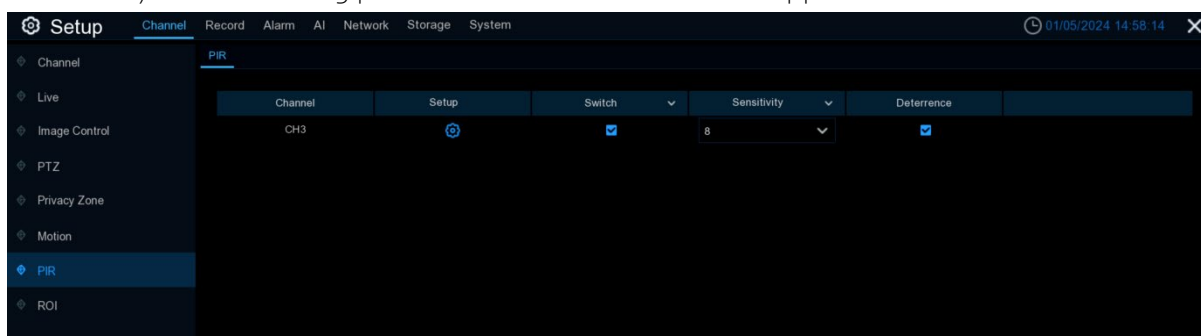

**Switch:** Enable or disable PIR detection.

**Sensitivity:** This option allows you to change the sensitivity level. The higher the number, the more sensitive your DVR will be when detecting PIR.

**Deterrence:** Enable and off the linked white light alarm (Note: IP cameras of version 8.2.3 and later this disposition is grayed out, the linked alarm switch can be turned on through the schedule, see 5.3.9 White Light Deterrent for details)

**Setup:** Click  to enter the setup page

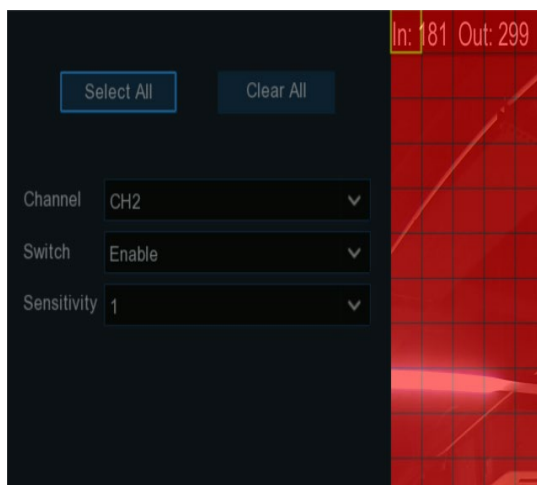

### PIR Detection Area

Click **Select All** to set the entire screen of the camera as the PIR detection area. Click **Clear All** to clear the entire area.

If you want to edit the size of the area, check the box and change the position.

When the settings are complete, click on the right mouse button to return and then click on **Apply** to make the area settings effective.

Return to the main screen, click the "Alarm" button to configure the PIR alarm function.

## 5.1.8 ROI

Regions of Interest (ROI) are selected regions for special attention in the video area. This function aims to improve the image encoding quality of the selected regions and reduce the encoding quality outside the selected regions, so as to ensure the image sharpness of the regions for special attention under the condition of constant bitrate. (Note: This function needs to be supported by the camera. It cannot be used with the H.264+ and H.265+ encoding types at the same time.)

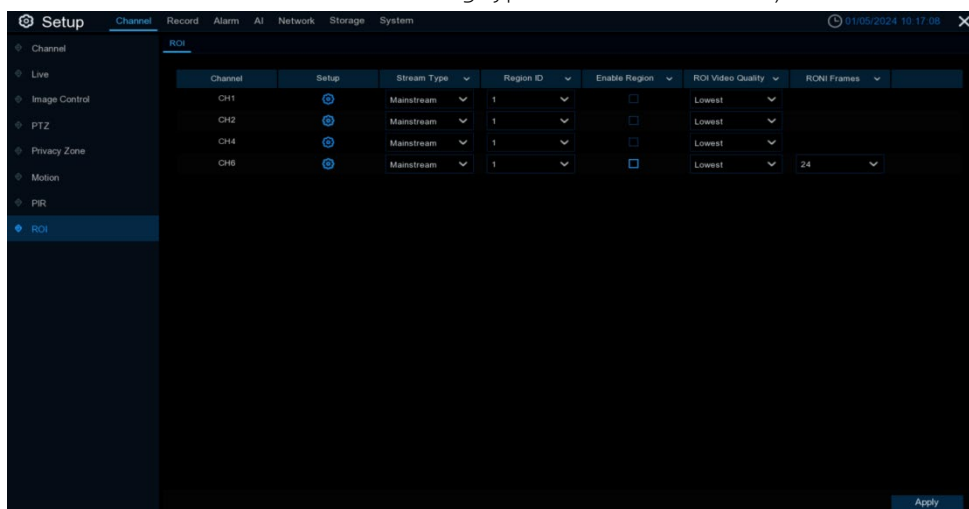

**Stream Type:** Select the stream type to set.

**Region ID:** Select the region ID to be set. You can set at most eight region IDs.

**ROI Video Quality:** Set the image quality in the region, the higher the quality the clearer and smoother the image.

**RONI Frames:** Set the frame rate of non-ROI area.

**Setup:** Click  to open the setting page.



**Area:** Enable the switch to set the ROI area.

## 5.2 Record

Through this menu, users can configure the system encoding, recording, capturing and other related parameters.

### 5.2.1 Encode

This menu allows you to configure the recording video or network transmission picture quality. Generally, Mainstream defines the recording video quality which will be saved in the HDD. Substream defines the video quality which is being viewed via remote access, for example web client & CMS/VMS. Mobile Stream defines the video quality which is being viewed via remote access via mobile devices.

#### 5.2.1.1 Mainstream

Channel	Event Type	Resolution	Frame Rate	Encoding Format	Encoding Mode	Config Mode	Bitrate	Audio	Frame Interval	ETR
CH1	Normal	3840 x 2160	30	H.265	CBR	Predefined	6144	<input checked="" type="checkbox"/>	60	<input type="checkbox"/>
CH2	Normal	1920 x 1080	25	H.264+	CBR	Predefined	4096	<input checked="" type="checkbox"/>		<input type="checkbox"/>
CH4	Normal	1920 x 1080	25	H.265	CBR	Predefined	4096	<input checked="" type="checkbox"/>	60	<input type="checkbox"/>
CH5	Normal	1920 x 1080	25	H.265	CBR	Predefined	4096	<input type="checkbox"/>	60	<input checked="" type="checkbox"/>
	Event	1920 x 1080	20	H.265	CBR	Predefined	3072	<input checked="" type="checkbox"/>	40	
CH6	Normal	1920 x 1080	30	H.264	CBR	Predefined	2048	<input checked="" type="checkbox"/>	60	<input type="checkbox"/>
CH7	Normal	2880 x 1620	30	H.265	CBR	Predefined	4096	<input checked="" type="checkbox"/>	60	<input type="checkbox"/>

**Resolution:** Set the resolution of the main stream video.

**Frame Rate:** Set the frame rate of the main stream video.

**Encoding Format:** encoding type of the channel, there are H.264, H.265, H.264+, H.265+.

**Encoding Mode:** For simple scenes, such as a gray wall, Constant Bit Rate (CBR) is appropriate. For more complex scenes, such as busy streets, Variable Bit Rate (VBR) is appropriate.

**Video Quality:** When VBR is selected as the encoding mode, the available image qualities are Lowest, Lower, Low, Medium, Higher and Highest.

**Config Mode:** Preset mode and customized mode are available. For preset mode, you need to select the bitrate through the drop-down list, and for custom mode, you need to input the bitrate manually.

**Bitrate:** This parameter corresponds to the bitrate used by the device to record video. The higher the bitrate, the better the image quality.

**Audio:** When accessing the camera that supports audio, enable audio, the main stream of the video channel has audio recording.

**I Frame Interval:** Set the I frame interval of the IP camera.

**ETR:** Use different code stream parameters for recording when alarm occurs and when non-alarm occurs.

### 5.2.1.2 Substream

Channel	Resolution	Frame Rate	Encoding Format	Encoding Mode	Config Mode	Bitrate	Audio	I Frame Interval
CH1	1280 x 720	30	H.265	CBR	Predefined	1024	<input checked="" type="checkbox"/>	60
CH2	1280 x 720	25	H.264	CBR	Predefined	1024	<input checked="" type="checkbox"/>	60
CH4	640 x 480	25	H.265	CBR	Predefined	512	<input checked="" type="checkbox"/>	60
CH5	640 x 480	20	H.265	CBR	Predefined	1024	<input checked="" type="checkbox"/>	40
CH6	1280 x 720	30	H.265+	CBR	Predefined	1024	<input checked="" type="checkbox"/>	
CH7	1280 x 720	30	H.265	CBR	Predefined	1024	<input checked="" type="checkbox"/>	60

**Resolution:** Set the resolution of the sub-stream video.

**Frame Rate:** Set the frame rate of the sub-stream video.

**Encoding Format:** channel encoding type, there are H.264, H.265, H.264+, H.265+ and MJPEG (when IP camera enables MJPEG encode, other IP cameras will prompt insufficient resources in preview).

**Encoding Mode:** Select the bitrate level. For simple scenes, e.g. a gray wall, Constant Bit Rate (CBR) is suitable. For more complex scenes, such as busy streets, Variable Bit Rate (VBR) is appropriate.

**Video Quality:** When VBR is selected as the encoding mode, the available image qualities are Lowest, Lower, Low, Medium, Higher and Highest.

**Config Mode:** Preset mode and customized mode are available. For preset mode, you need to select the bitrate through the drop-down list, and for custom mode, you need to input the bitrate manually.

**Bitrate:** This parameter corresponds to the bitrate used by the device to record video. The higher the bitrate, the better the image quality.

**Audio:** If you need to record audio and video at the same time, access the camera with audio function and enable this option.

**I Frame Interval:** Set the I frame interval of the IP camera.

### 5.2.1.3 Mobile Stream

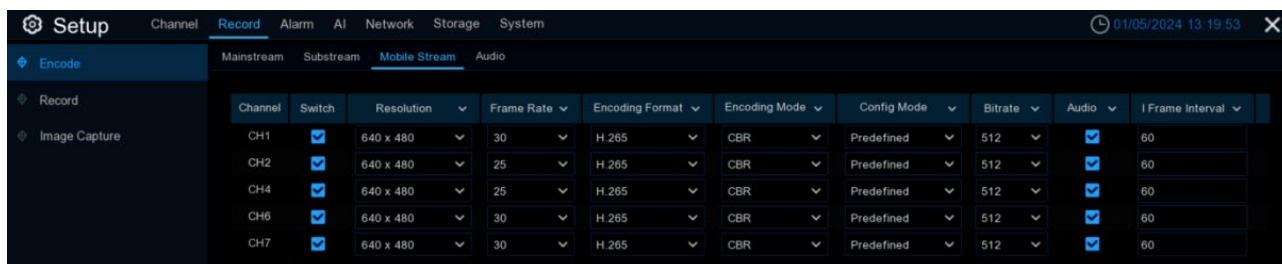

**Switch:** Enable or disable cell phone streaming

**Resolution:** Set the resolution of the phone streaming video

**Frame Rate:** Set the frame rate of the cell phone streaming video.

**Encoding Format:** channel encoding type, there are H.264, H.265, H.264+, H.265+.

**Encoding Mode:** Select the bit rate level. For simple scenes, such as a gray wall a Constant Bit Rate (CBR) is appropriate. For more complex scenes, such as busy streets, Variable Bit Rate (VBR) is appropriate.

**Video Quality:** When VBR is selected as the encoding mode, the available image qualities are Lowest, Lower, Low, Medium, Higher and Highest.

**Config Mode:** Preset mode and customized mode are available. For preset mode, you need to select the bitrate by drop-down, and for custom mode, you need to input the bitrate manually.

**Bitrate:** This parameter corresponds to the data transfer rate used by DVR to record video. Higher bitrate video will have better quality.

**Audio:** If you need to record audio and video at the same time, access the camera with audio function and enable this option.

**I Frame Interval:** Set the I frame interval of the IP camera.



## 5.2.1.4 Audio

Setting audio-related parameters of IP cameras (need camera support)

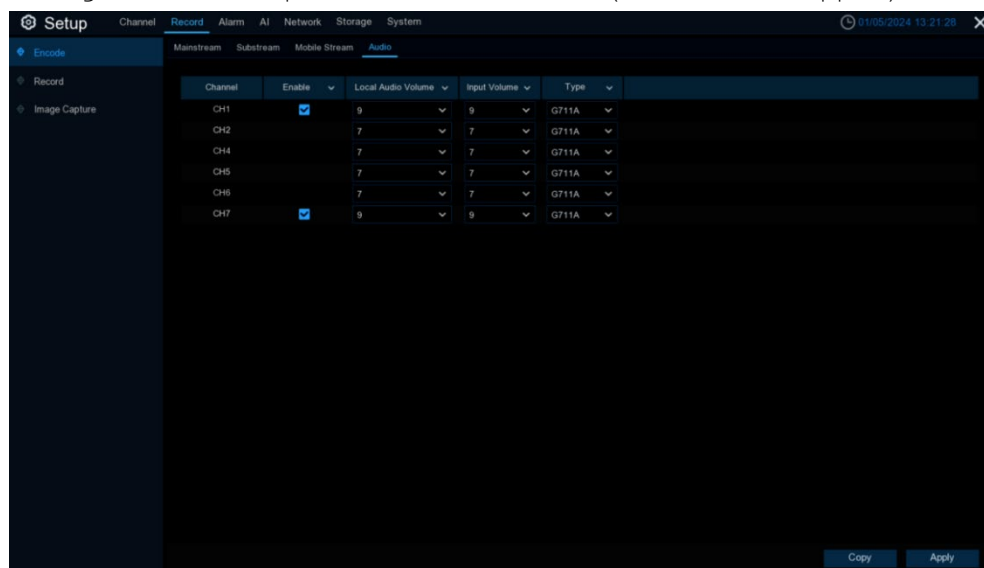

**Enable:** Enable camera audio.

**Output Volume:** Set camera output volume.

**Input Volume:** Set camera input volume.

**Type:** Set camera audio decode type.

## 5.2.2 Record

This menu allows you to configure the channel recording parameters.

### 5.2.2.1 Record

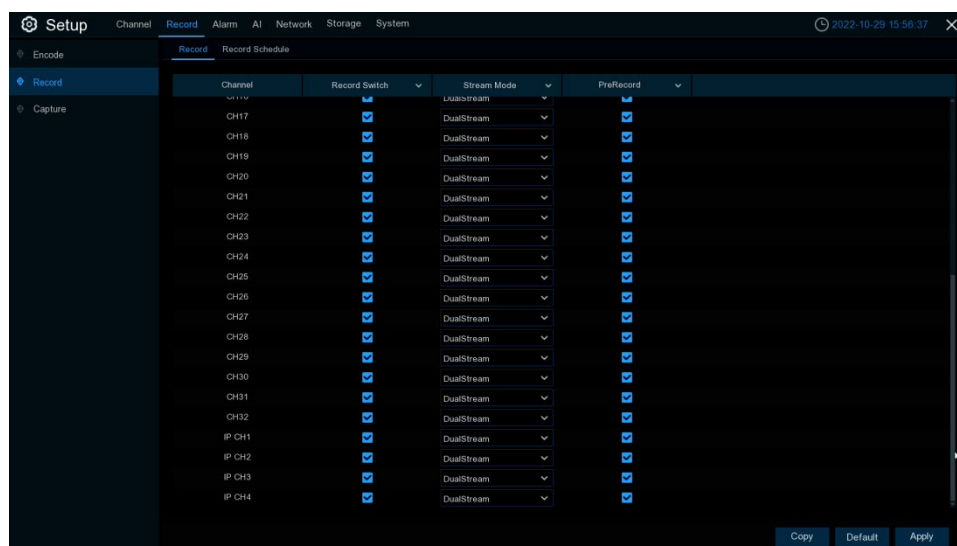

**Record Switch:** Check to enable the recording in this channel.

**Stream Mode:** Choose the recording quality. If you choose Dual-stream, the system will record in both Mainstream & Sub stream.

**PreRecord:** If this option is enabled, the DVR starts recording a few seconds before an alarm event occurs. Use this option if your primary recording type is motion or I/O alarm based.

### 5.2.2.2 Record Schedule

This menu allows you to specify when the DVR records video and defines the recording mode for each channel. The recording schedule lets you set up a schedule like, daily and hourly by normal (continuous) recording, motion recording, I/O alarm recording & PIR recording (if your DVR supports). To set the recording mode, click first on the mode radio button (Normal, Motion, IO, PIR), then drag the cursor to mark the slots. The recording schedule is valid only for one channel. If you want to use the same recording schedule for other channels, use **Copy** function. Click **Apply** to save your settings.

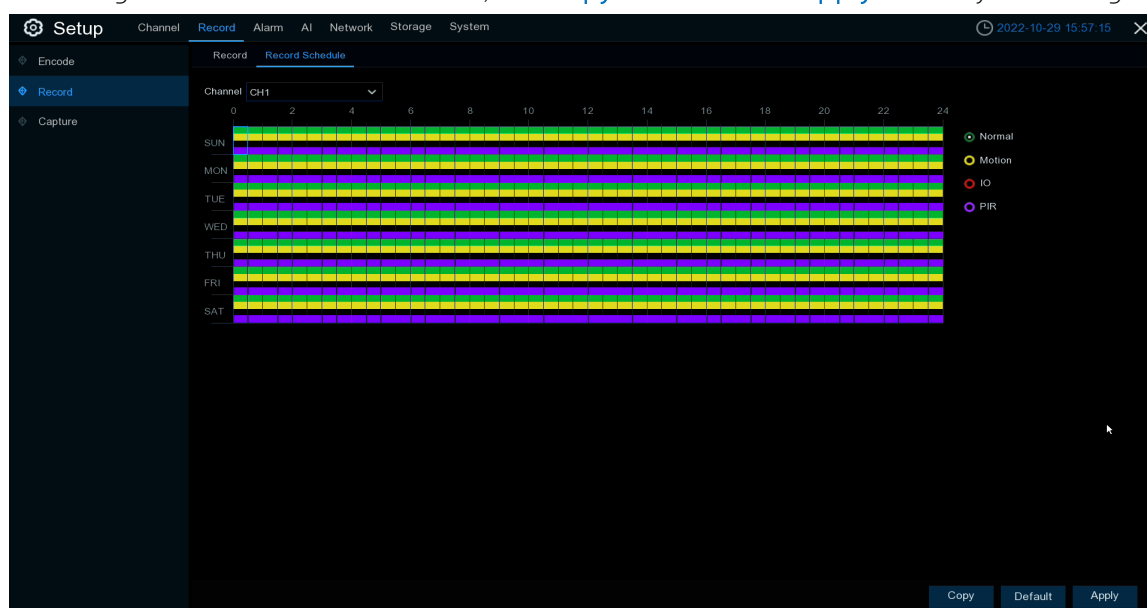

**Channel:** Select the channel to set its recording parameters.

**Normal:** When the time slot is marked **green**, this indicates the channel performs normal recording for that time slot.

**Motion:** When the time slot is marked **yellow**, this indicates the channel records only when a motion is detected during that time slot.

**IO:** When the time slot is marked **red**, this indicates the channel records only when the sensor is triggered during that time slot.

**PIR:** When the time slot is marked **purple**, this indicates the channel records only when the PIR is triggered during that time slot.

**No Record:** A time slot marked black means that there is no recording scheduled for the time slot.

## 5.2.3 Capture

This menu allows to configure the image capture function.

### 5.2.3.1 Capture

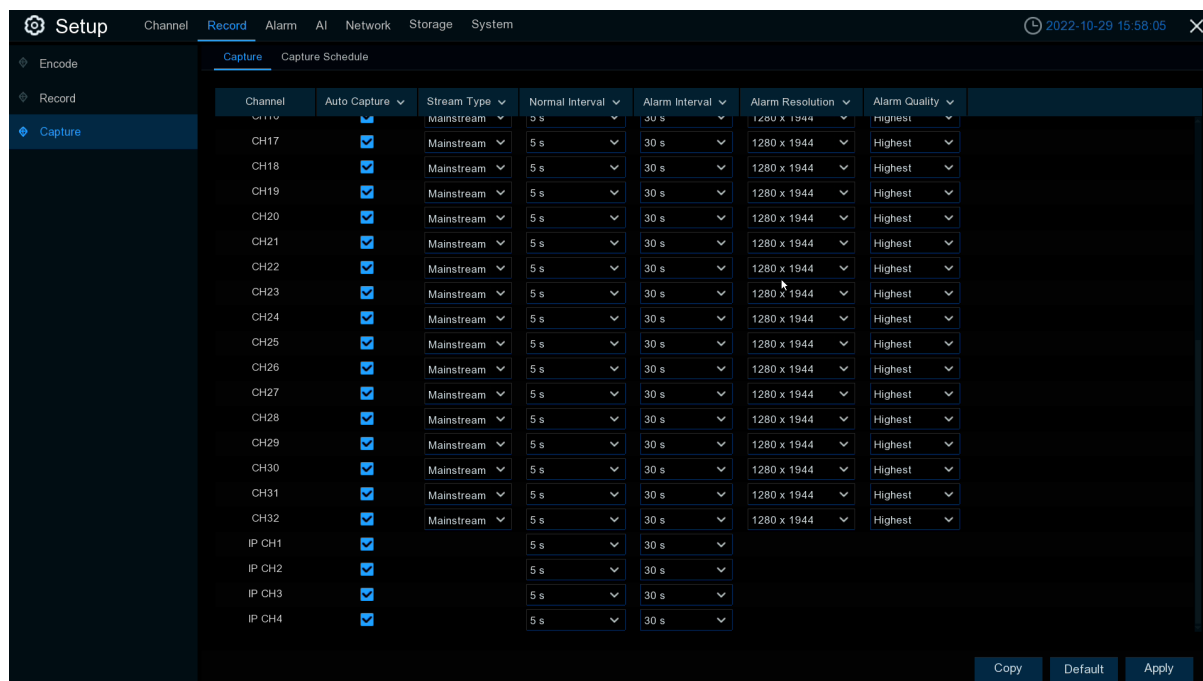

**Auto Capture:** Enable or disable automatic capturing on the channel.

**Stream Type:** Select the image resolution by mainstream or sub stream.

**Normal Interval:** Time interval to capture an image in normal recording.

**Alarm Interval:** Time interval to capture an image when motion, IO alarm or PIR is triggered.

**Alarm Resolution:** Select the resolution of the picture to be captured automatically when the alarm occurs, only analogue channels are supported.

**Alarm Quality:** Select the picture quality of the automatic alarm capture, the higher the quality, the clearer the picture, only supports analogue channels.

## 5.2.3.2 Capture Schedule

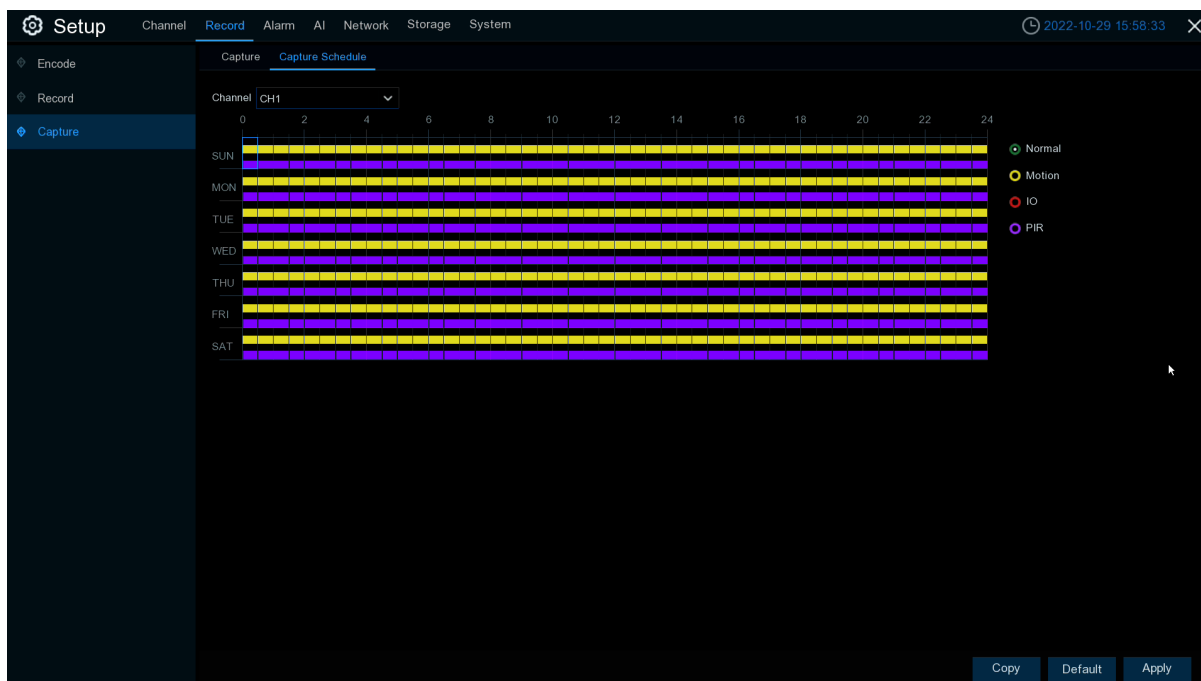

**Normal:** When the time slot is marked green, this indicates the channel performs normal capture for that time slot.

**Motion:** When the time slot is marked yellow, this indicates the channel capture images only when a motion is detected during that time slot.

**IO:** When the time slot is marked red, this indicates the channel capture images only when the sensor is triggered during that time slot.

**PIR:** When the time slot is marked purple, this indicates the channel capture images only when the PIR is triggered during that time slot.

**No Capture:** A time slot marked black means that it won't capture any images for the time slot, but you can manually capture images if you enable the manual capture function in the channel.

## 5.3 Alarm

In these section, you can configure the alarm parameters.

### 5.3.1 Motion Detection

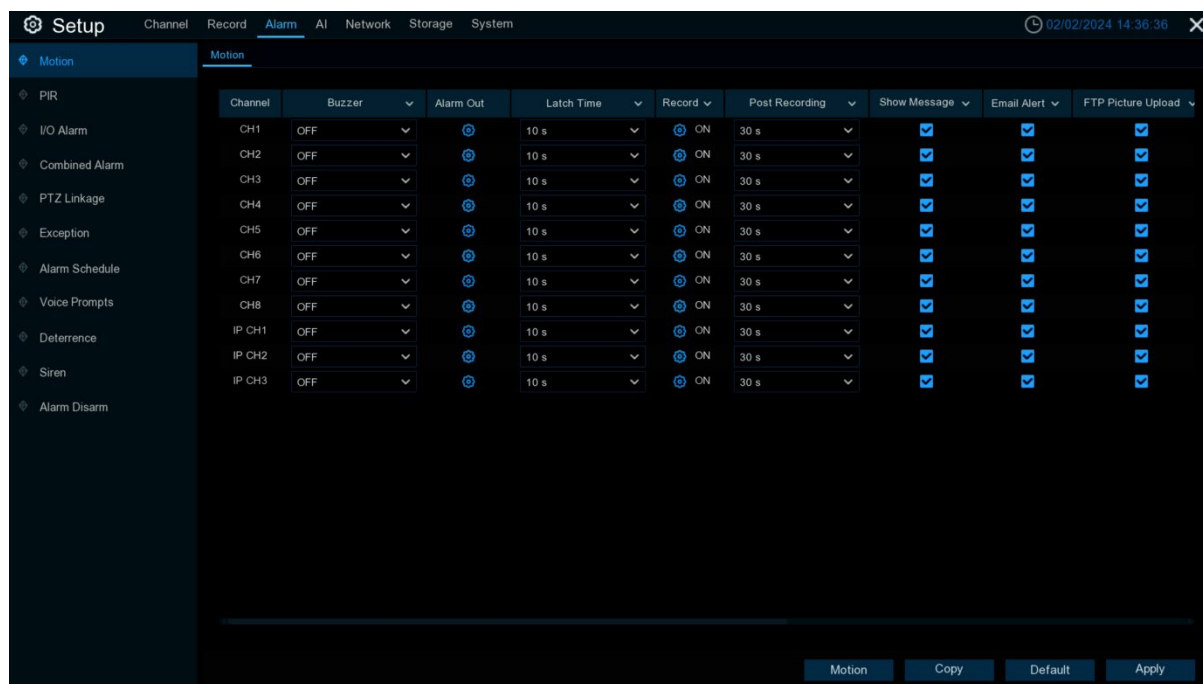

**Channel:** The name of the channel.

**Buzzer:** The DVR can use its internal buzzer to sound an alarm tone. Set the buzzer duration in seconds when motion is detected.

**Alarm Out:** Optional feature. If the DVR supports connection to an external alarm device, you can set the external alarm device.

**Latch Time:** Configure the external alarm trigger time (10s, 20s, 40s and 1Min) when motion is detected.

**Record:** Click  icon to select the channel to record when motion detection is triggered.

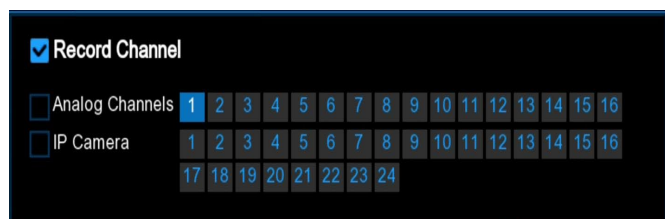

**Post Recording:** Set the length of time the DVR will continue to record after an event. The recommended recording time is 30 seconds, but can be set to a maximum of 5 minutes.

**Show Message:** When the detection is triggered, the alarm icon  will appear on screen.

**Email Alert:** An email alert will be sent when alarm event is detected. Tick the checkbox if you want to disable this.

**FTP Picture Upload:** Upload an alarm picture to an FTP server after an alarm is triggered.

**FTP Video Upload:** Upload an alarm video to an FTP server when the alarm is triggered.

**Picture to Cloud:** Upload an alarm picture to cloud storage when the alarm is triggered.

**Video to Cloud:** Upload an alert video to cloud storage after an alert is triggered.

**Full Screen:** Click the checkbox to view the camera full-screen in Live View mode when the detection is triggered.

**Event push Platform:** Click the checkbox, this type of message will be pushed to the client when an alarm is triggered.

**Voice Prompts:** The audio file into which the voice prompt is imported when this alarm is triggered (requires IPC support for voice prompts).

### 5.3.2 PIR

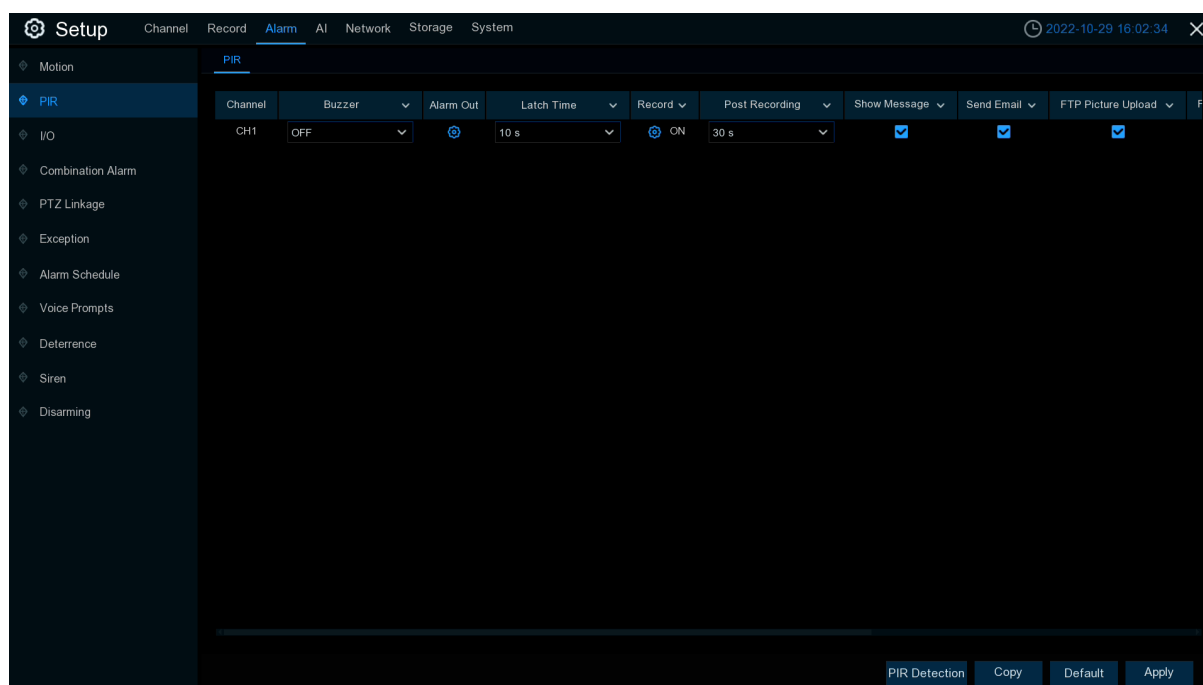

This menu allows you to configure the parameters related to PIR alarms.

**Channel:** The name of the channel.

**Buzzer:** The DVR can use its internal buzzer to sound an alarm tone. Set the buzzer duration in seconds when motion is detected.

**Alarm Out:** Optional feature. If the DVR supports connection to an external alarm device, you can set the external alarm device.

**Latch Time:** Configure the external alarm trigger time (10s, 20s, 40s and 1Min) when PIR is detected.

**Record:** Click  icon to select the channel to record when PIR detection is triggered.



**Post Recording:** Set the length of time the DVR will continue to record after an event. The recommended recording time is 30 seconds, but can be set to a maximum of 5 minutes.

**Show Message:** When the PIR is triggered, the alarm icon **PIR** will appear on screen.

**Email Alert:** An email alert will be sent when alarm PIR is detected. Tick the checkbox if you want to disable this.

**FTP Picture Upload:** Upload an alarm picture to an FTP server after an alarm is triggered.

**FTP Video Upload:** Upload an alarm video to an FTP server when the alarm is triggered.

**Picture to Cloud:** Upload an alarm picture to cloud storage when the alarm is triggered.

**Video to Cloud:** Upload an alert video to cloud storage after an alert is triggered.

**Full Screen:** Click the checkbox to view the camera full-screen in Live View mode when the detection is triggered.

**Event push Platform:** Click the checkbox, this type of message will be pushed to the client when an alarm is triggered.

**Voice Prompts:** The audio file into which the voice prompt is imported when this alarm is triggered (requires IPC support for voice prompts).

### 5.3.3 I/O Alarm

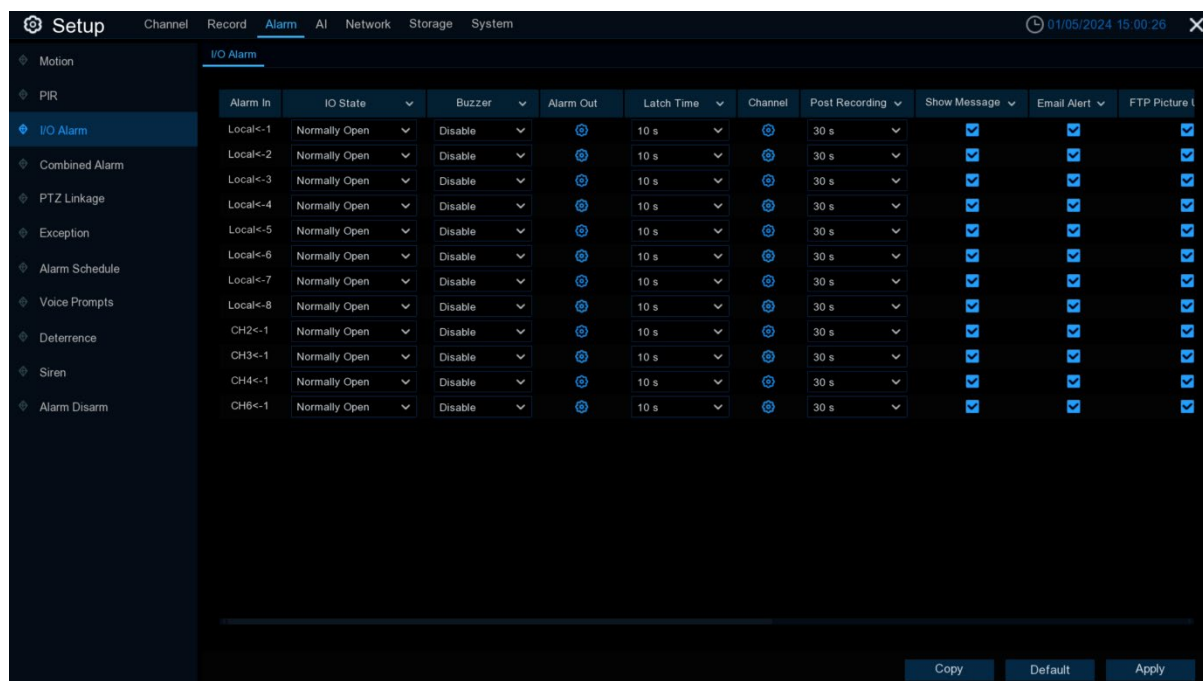

**Alarm In:** Alarm input channel

**IO State:** 3 types can be selected: normally open, normally closed and closed. The selection must be consistent with the type of sensor to be accessed, selecting "Off", the I/O will not be triggered.

**Buzzer:** The DVR can use its internal buzzer to sound an alarm tone. Set the buzzer duration in seconds when I/O Alarms is detected.

**Alarm Out:** Optional feature. If the DVR supports connection to an external alarm device, you can set the external alarm device.

**Latch Time:** Configure the external alarm trigger time (10s, 20s, 40s and 1Min) when PIR is detected.

**Record:** Click  icon to select the channel to record when I/O Alarms is triggered.

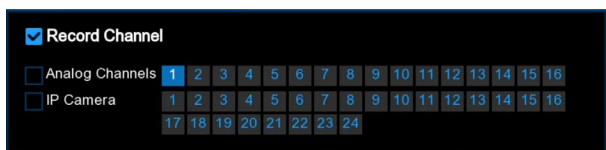

**Post Recording:** Set the length of time the DVR will continue to record after an event. The recommended recording time is 30 seconds, but can be set to a maximum of 5 minutes.

**Show Message:** When the PIR is triggered, the alarm icon  will appear on screen.

**Email Alert:** An email alert will be sent when alarm I/O Alarms is triggered. Tick the checkbox if you want to disable this.

**FTP Picture Upload:** Upload an alarm picture to an FTP server after an alarm is triggered.

**FTP Video Upload:** Upload an alarm video to an FTP server when the alarm is triggered.

**Picture to Cloud:** Upload an alarm picture to cloud storage when the alarm is triggered.

**Video to Cloud:** Upload an alert video to cloud storage after an alert is triggered.

**Full Screen:** Click the checkbox to view the camera full-screen in Live View mode when the I/O Alarms is triggered.

**Event push Platform:** Click the checkbox, this type of message will be pushed to the client when an alarm is triggered.

**Voice Prompts:** The audio file into which the voice prompt is imported when this alarm is triggered (requires IPC support for voice prompts).



### 5.3.4 Combination Alarm

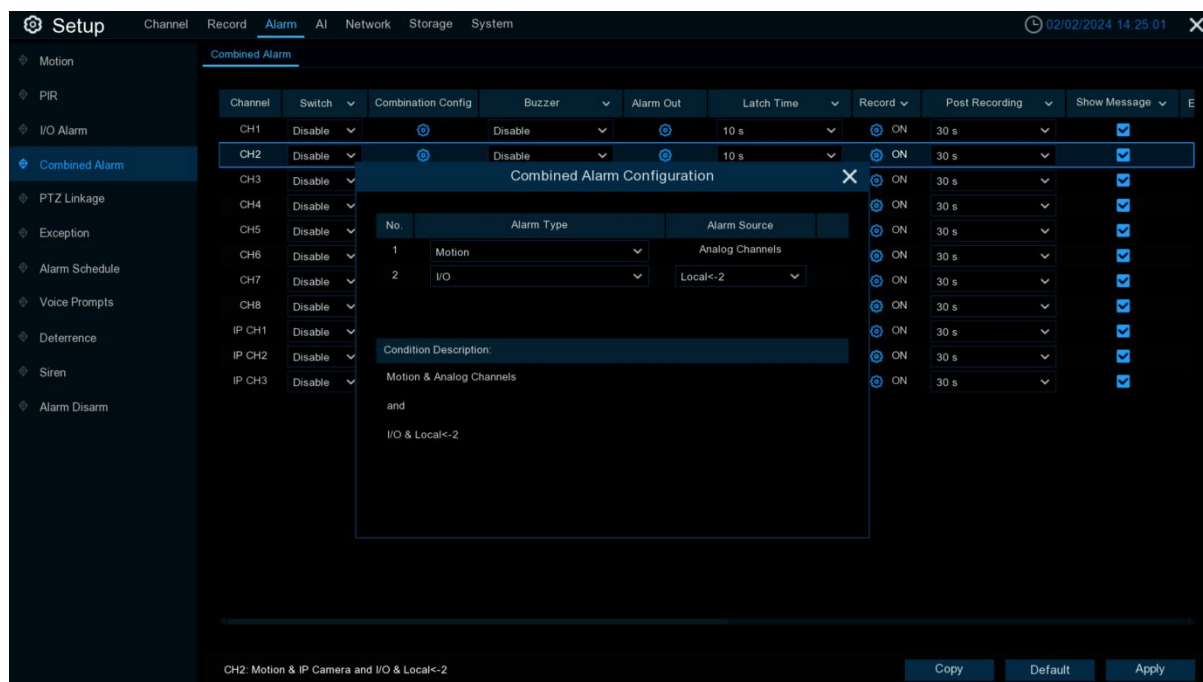

**Channel:** Channel name

**Enable Alarm:** whether channel combination alarm can be set, **Enable** enables combination alarm (combination alarm system parameter of the channel configuration takes effect, alarm parameter set separately by the channel is not effective). **Disable** does not enable combination alarm (combination alarm system parameter configured by the channel is not effective, and event alarm system parameter set separately by the channel does take effect).

Channel combination alarm is enabled. **Combination Configure** selects two alarm types. When both alarms are triggered within the same time period, the notification information such as buzzer, mail, push, upload is enabled. When this menu is enabledly one of the alarms is triggered or when it is not triggered or when alarms other than the combination occurs, email, push and other notifications will not be sent. Two alarm types can be combined casually.

For example, the channel sets the "Alarm->Combination Alarm" as per **Perimeter**

#### **Intrusion+MOTION**

1. Configure the CH 1 **Alarm-> Combination Alarm** alarm response system parameters. Configure the alarm combination type **Motion + Perimeter Intrusion**. Set up the **Buzzer Alarm Out, Latch time, Record, Post recording, Show Message, Send Email, Picture to Cloud, Video to Cloud, Full Screen, Voice Prompts**.

2. When the CH 1 combination alarm switch is enabled and **Motion + Perimeter Intrusion** is triggered at the same time, (the response combination parameters configured by the buzzer, mail, push, upload, etc. are not the system alarm parameters configured separately for the

response event). For mail: The client is named by event. When the combined alarm is turned on, if the CH4 triggers an alarm other than the **Motion + Perimeter Intrusion** alarm, the other alarm will not respond to the alarm system parameters (such as Line Crossing Detection, Object Detection, etc.) corresponding to the CH4 alarm setting. Turn off the CH4 combination alarm switch, and each set event alarm of CH4 separately responds to the respective configured system alarm parameters.

**Buzzer:** The DVR can use its internal buzzer to sound an alarm. You can set the buzzer duration (in seconds) when triggering a combined alarm.



**Alarm out:** Check whether the external alarm device is triggered when the combination alarm is triggered.

**Latch Time:** You can set the duration of triggering the external alert devices (10s, 20s, 40s, and 1Min).

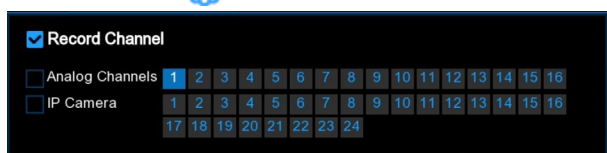
**Record:** Click  icon and select the channel to record when triggering the combination alarm.



**Post Recording:** Set the length of time the DVR will continue to record after an event. The recommended recording time is 30 seconds, but can be set to a maximum of 5 minutes.

**Show Message:** Check this box to display the corresponding alarm icon on the live display when a combination of alarms is detected. E.g. Motion+Perimeter Intrusion alarm triggered, show  and  icon.

**Email Alert:** The DVR sends an automated e-mail to the mailbox when it detects an alarm.

**FTP Picture Upload:** Upload an alarm picture to an FTP server after an alarm is triggered.

**FTP Video Upload:** Upload an alarm video to an FTP server when the alarm is triggered.

**Picture to Cloud:** Upload an alarm picture to cloud storage when the alarm is triggered.

**Video to Cloud:** Upload an alert video to cloud storage after an alert is triggered.

**Full Screen:** Click the checkbox to view the camera full-screen in Live View mode when the Alarms is triggered.

**Event push Platform:** Click the checkbox, this type of message will be pushed to the client when an alarm is triggered.

**Voice Prompts:** The audio file into which the voice prompt is imported when this alarm is triggered (requires IPC support for voice prompts).

### 5.3.5 PTZ Linkage

If a PTZ camera is connected, you can set up a linkage between the PTZ camera and an Alarm alarm. Using the linkage feature, you can focus the PTZ camera on a preset point when any of the Alarm alarm types are triggered.

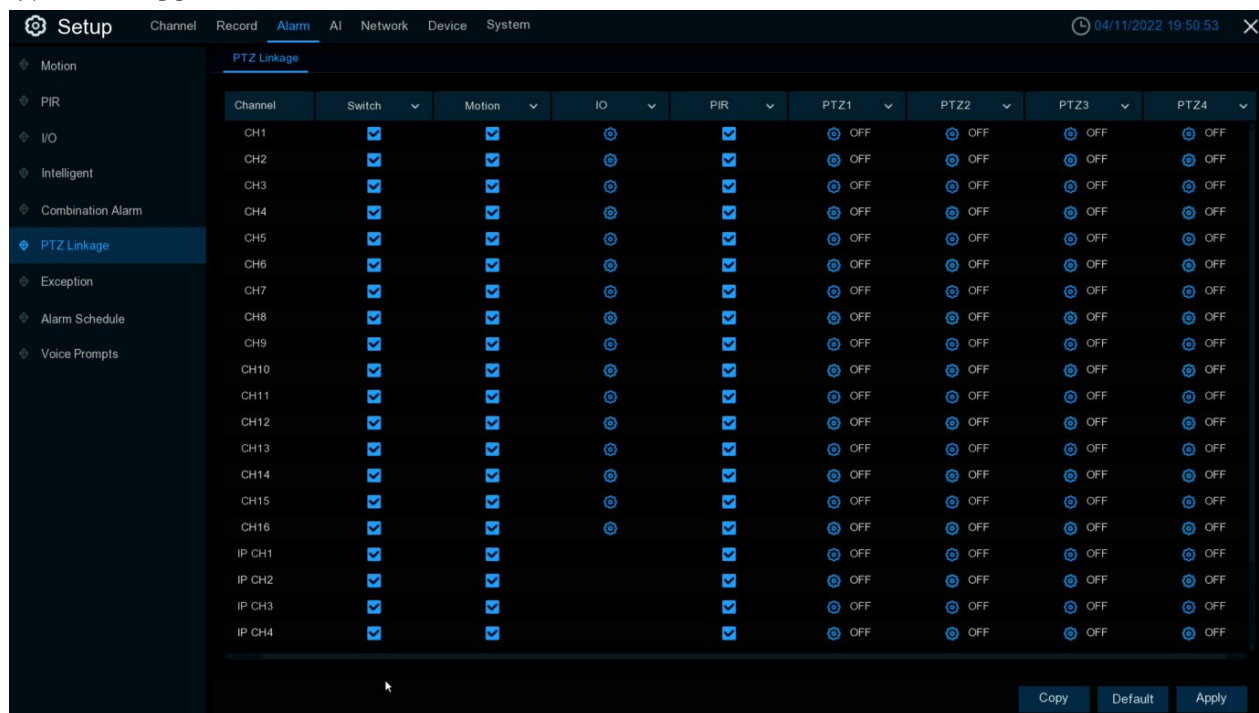

**Switch:** Enable or disable the PTZ linkage function.

**Alarm:** Click the  icon to set the alarm type to be associated with PTZ (Note: the alarm types supported by the XVR are shown here, not the alarm types supported by the channel, except for I/O)

**PTZ:** Click the  icon to associate with PTZ camera preset points.

### 5.3.6 Exception

The system allows to set the abnormal events that you want the NVR to inform you.

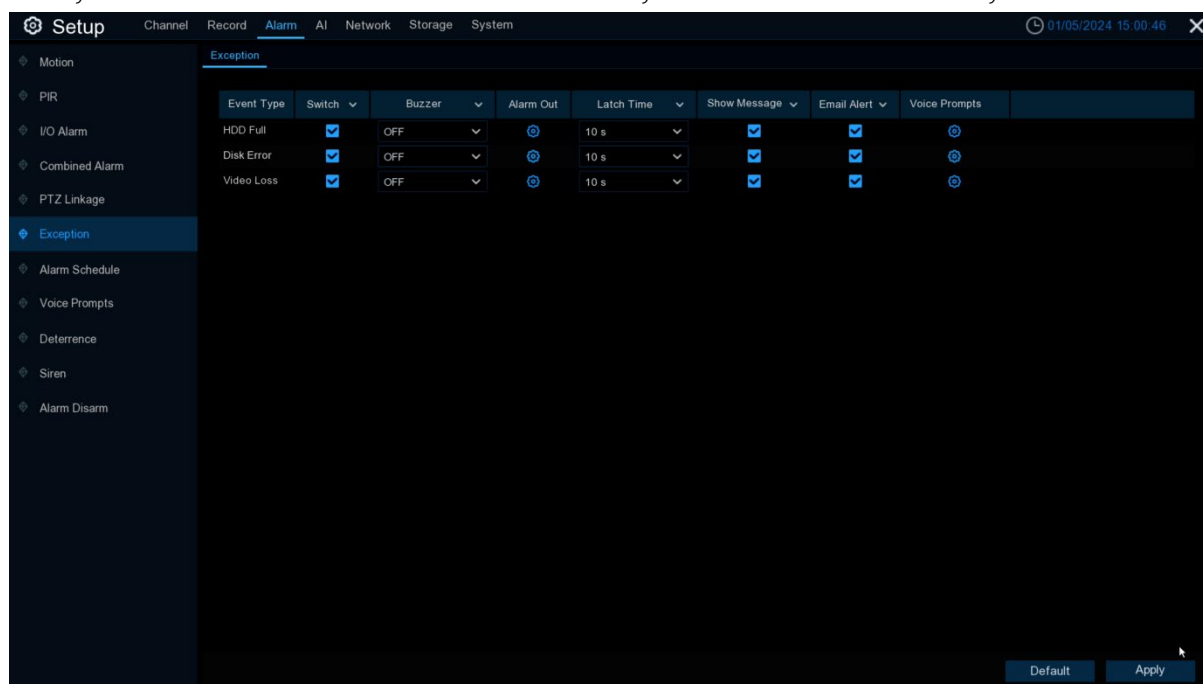

**Event Type:** There are three event types that your NVR will detect as an exception:

**No Space on Disk:** no space left on the hard drive.

**Disk Error:** a hard drive error.

**Video Loss:** one or more channels have lost the connection.

**Switch:** Check to enable event alerts.

**Buzzer:** Set the duration of the buzzer when an event occurs (OFF / 10s / 20s / 40s / 1Min). To disable the buzzer, select OFF.

**Latch Time:** Set the time to trigger the external alarm device (10s, 20s, 40s and 1Min).

**Alarm Out:** Check the box to enable the external alarm device to be triggered when an abnormal alarm is triggered.

**Show Message:** Check the box to display a message on the screen when No Space on Disk, Disk Error, or Video Loss event happens.

**Email Alert:** Click the checkbox to enable your NVR to send an email alert when the detection is triggered.

**Voice Prompts:** The audio file into which the voice prompt is imported when this alarm is triggered (requires IPC support for voice prompts).

### 5.3.7 Alarm Schedule

In this menu, users can set the time period for external alarm output devices, push, FTP upload, cloud upload, buzzer and other alarm response types to work through the schedule .

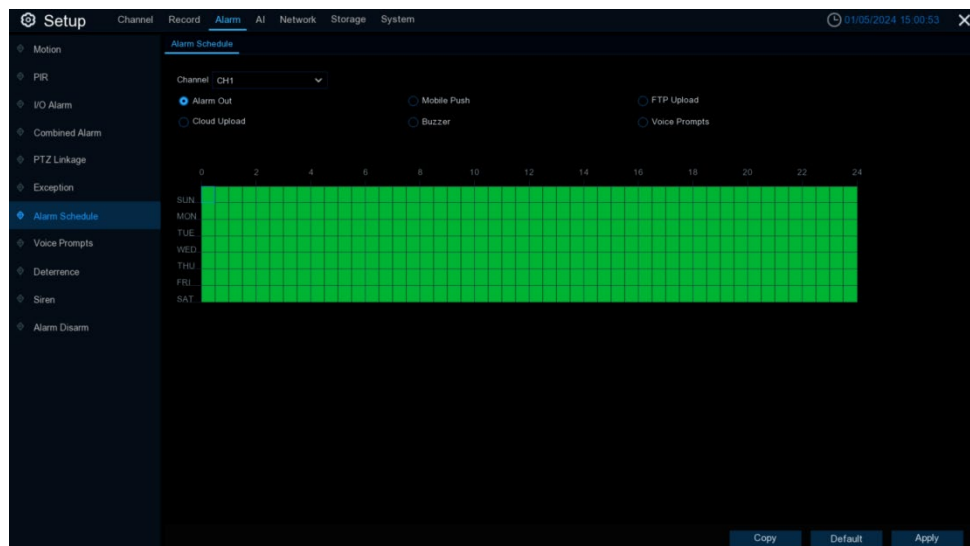

**Channel:** Select the channel and set its capture parameters.

When the time slot is marked in green, it means the channel is working for that time slot.

### 5.3.8 Voice Prompts

This function is used when the alarm occurs, the system receives the alarm signal and voice broadcasting equipment for linkage, automatically or manually on the scene "invasion" behavior play the associated audio.

### 5.3.8.1 File Management

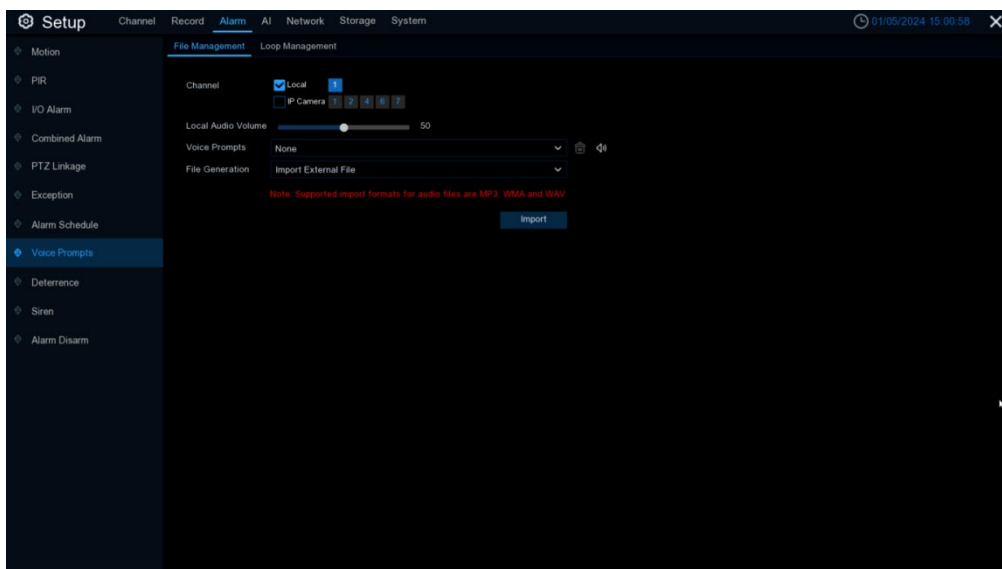

Click **import** to import broadcast audio, support two kinds of audio import methods, respectively, Import External File, Text-to-Speech (Internet).

**Import External File:** local import (supports importing MP3, WMA, WAV format audio files)

**Text-to-Speech (Internet):** Web server translation (by locally inputting the text content to be translated. Sent to the network server for translation into audio files. It is automatically saved to the local hard disk for storage)

The maximum input length of the text input box is 200 bytes.

**Import File:** Import audio file, the allowed file size for face and license plate library is 1~500K, and the allowed file size for non-face and license plate library is 1~5M.

After importing audio, it can be selected in **Voice Prompts**.

Voice Prompts: Support 2 kinds of Prompts, respectively: Local and IPC channel.

**Local Audio Volume:** you can adjust the volume output size of local broadcasting.

**Local:** local broadcasting (when selecting this type of broadcasting, the device side needs to be connected to the audio output device)

**IPC:** IP Camera Broadcasting (to select this broadcasting method, the camera program must have the voice broadcasting function, and at the same time, the camera side must support audio output)

Voice broadcast settings by time period: an alarm type can support the setting of up to 12 time periods of voice broadcast, the start and end time of any time period, there can be no conflicts

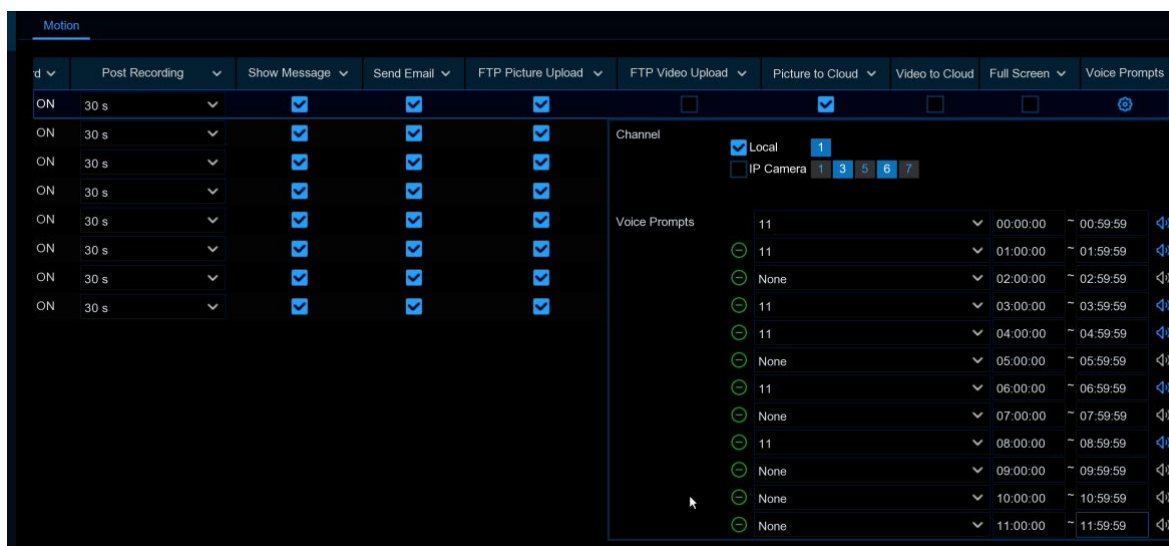

Face recognition-based voice broadcast settings: This function is to realize the face recognition occurs. The system collects the alarm signal and links with the voice broadcasting equipment to automatically play the associated audio to the "invasion" object on the scene. (Note: the audio imported based on the black and white list face pictures can only be used for the associated pictures)

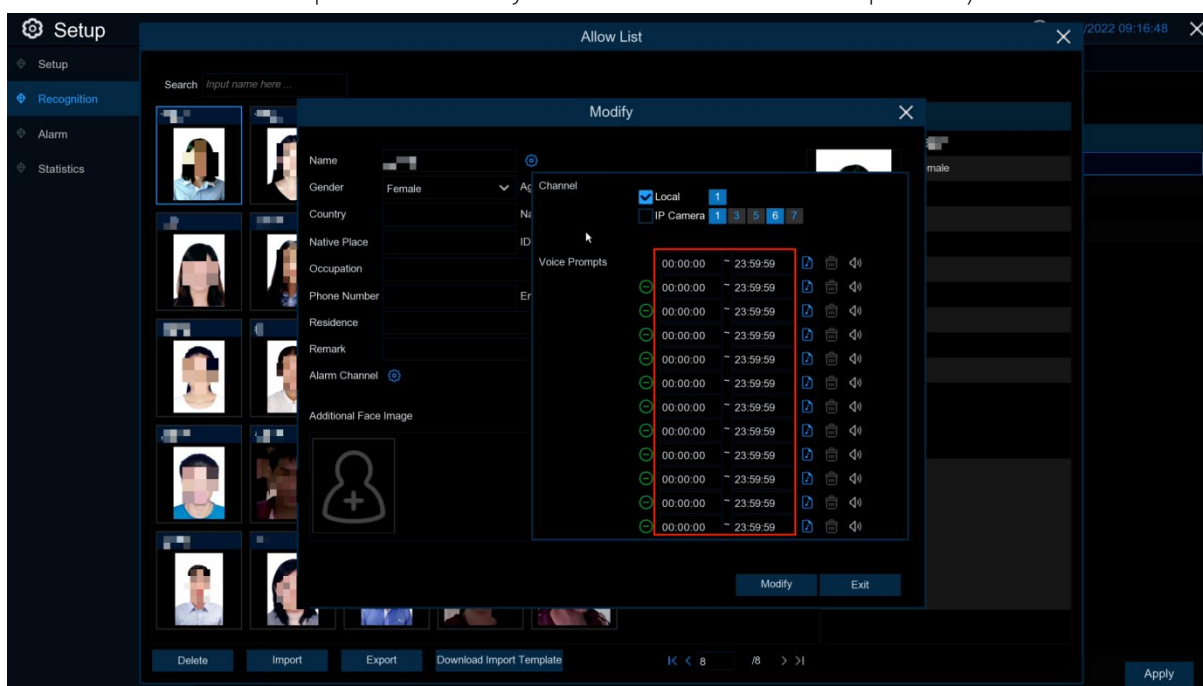

That is, when the face triggers the face detection, there will be voice announcement prompts

## 5.3.8.2 Loop Management

The system allows to play a continuous loop of the voices in a certain period of time.

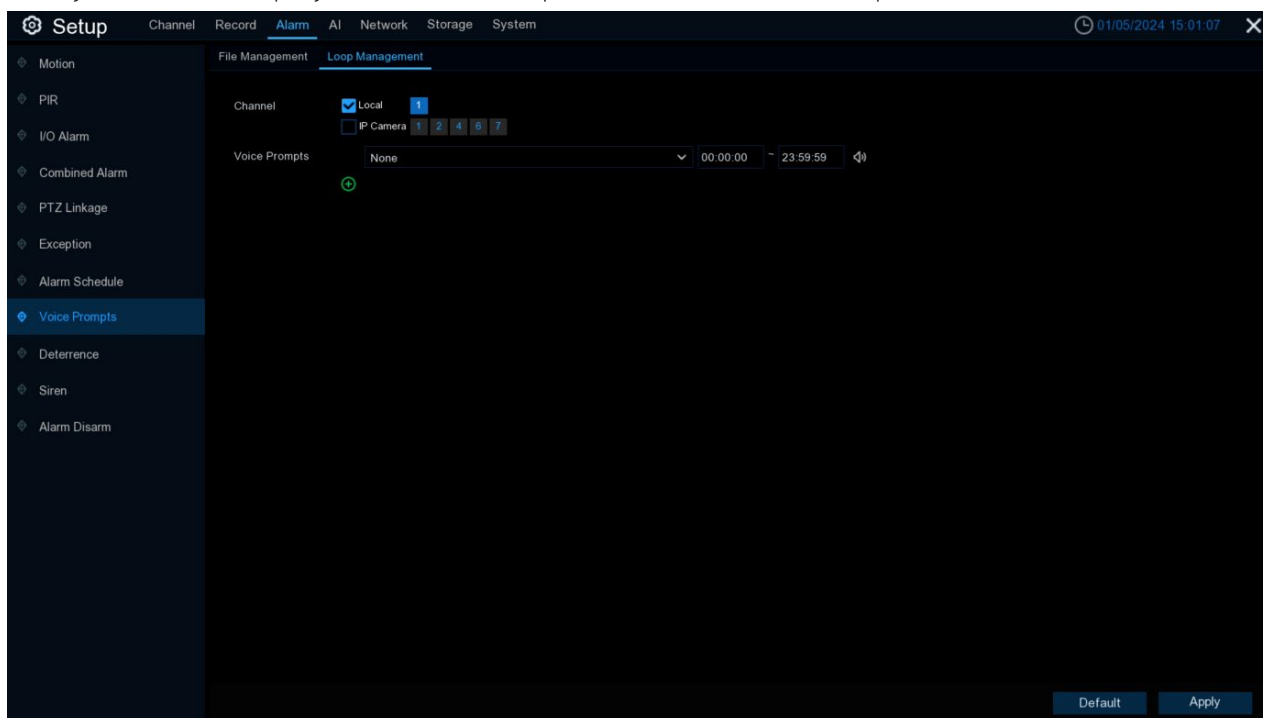

**Voice Prompts:** selects the audio file. After setting a time period, the selected audio file will be played in a loop for that time period when there is no voice announcement or audition audio file for the alarm. Up to 12 time slots are supported.

**Local:** local broadcasting (when selecting this type of broadcasting, the device side needs to be connected to the audio output device)

**IPC:** IP Camera Announcement (to select this type of announcement, the camera program must be equipped with the voice announcement function, and the camera side must support audio output).



### 5.3.9 Deterrence

This menu allows you to configure the action of built-in white lights (also known as "spotlights") and speaker of the deterrence cameras when an alarm event is detected.

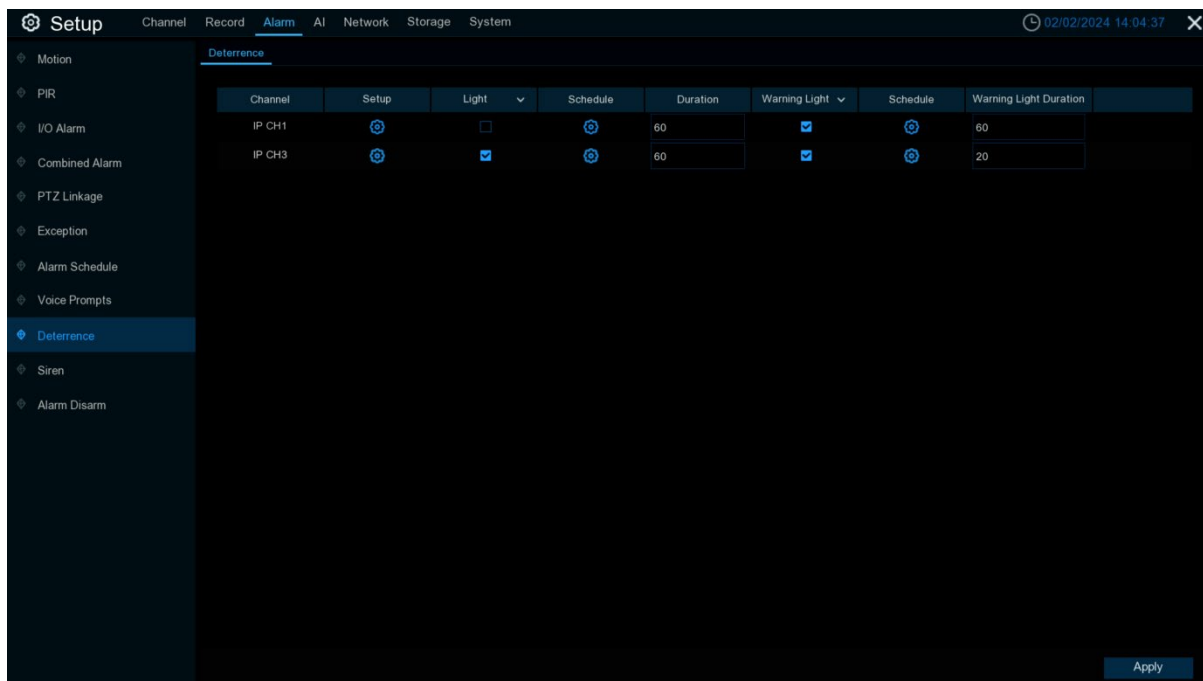

**Channel:** Channel name.

**Setup:** Click button to enter configuration page.

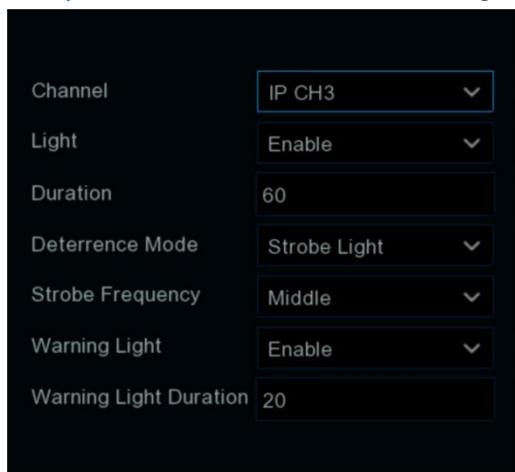

**Channel:** Channel name.

**Light:** Turn the light warning on or off.

**Duration:** White light duration.

**Deterrence Mode:** set the white light mode, there are constant mode Warning Light and flashing mode Strobe Light.

**Strobe Frequency:** the flashing frequency of the white light, there are high, medium and low three optional.

**Warning Light:** Enable and off the red and blue warning light.

**Warning Light Duration:** Duration of the red and blue lights.

**Schedule:** Click on the  icon to open the settings page.

When the IPC is accessing the NVR with **Media** port, the setup page is shown below:

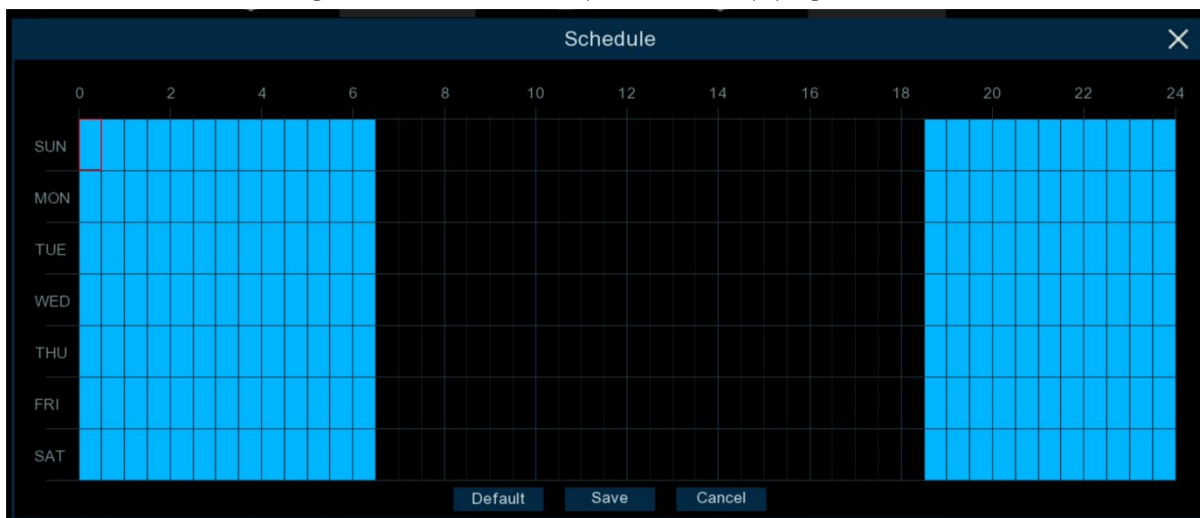

When this schedule is marked in light blue, it indicates that the channel can trigger a white light deterrent alarm for this time slot.

**Default:** Restore the default setting.

Note: Enable the Deterrence switch in the Motion or PIR setting, the white light and red and blue lights will be triggered when triggering the motion or PIR.

When the IPC is accessing the NVR with **HTTP** port, the setup page is shown below:

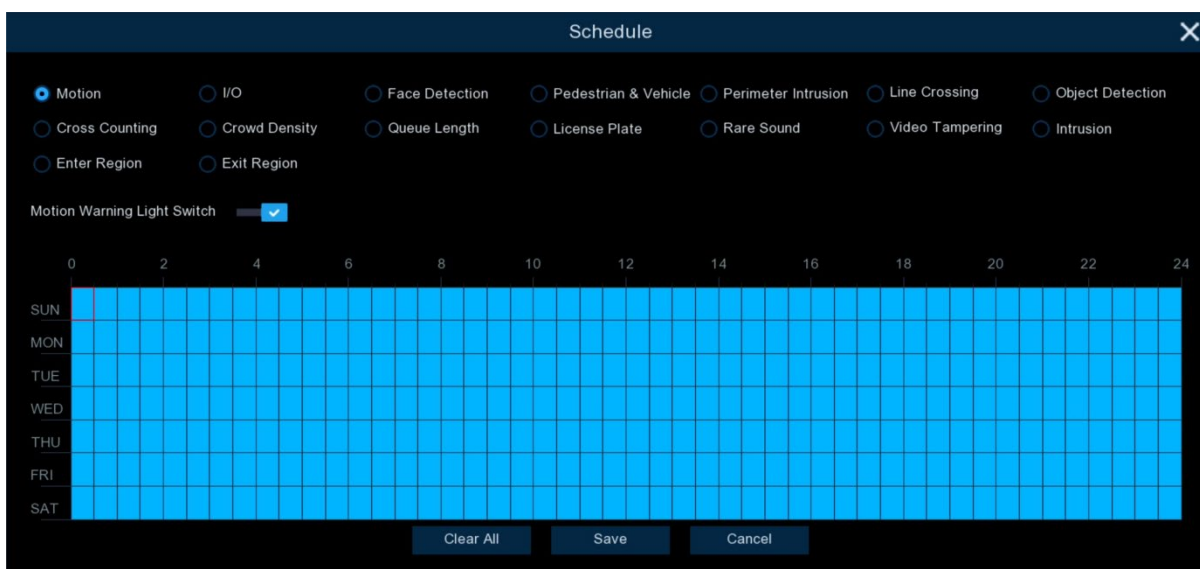

Select the corresponding function and the corresponding Switch. Set the linkage alarm and effective time.

**Clear All:** Clear the light blue mark of all sub-pages.

### 5.3.10 Siren

If the camera connected to the device has a built-in speaker, you can set the siren-related parameters in this module.

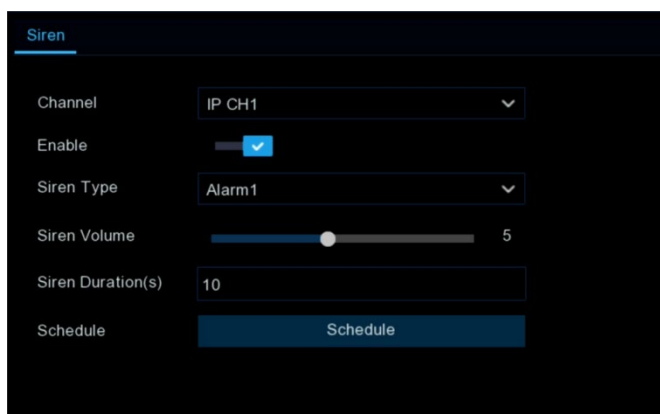

**Channel:** Select the switch channel.

**Enable:** Used to set whether to enable the siren function.

**Siren Type:** Used to select the siren audio file. By default two audio files are provided. You can also import three customized audio files (of PCM format or WAV format). The audio sample rate of the imported file cannot exceed 8000 Hz, and the file size cannot exceed 256 KB. After you select a customized audio file to be imported, **Delete** button appears on the right of the file, and you can Click the **Delete** button to delete the audio file. (Note: This function is supported by some IP cameras only.)

**File Name:** If you select **User-defined** for **Siren Type**, you can enter the file name and click the **Import** button on the right to import the customized audio file from a USB flash disk.

**Siren Level:** Used to set the siren volume level, which ranges from 1 to 10. The higher the level is, the louder the volume is.

**Siren Duration(s):** Used to set the siren duration. You can adjust the value between 5 to 180 seconds.

**Schedule:** If the IP camera is connected to the NVR via the HTTP port, you can Click the **Schedule** button to open the setting page.

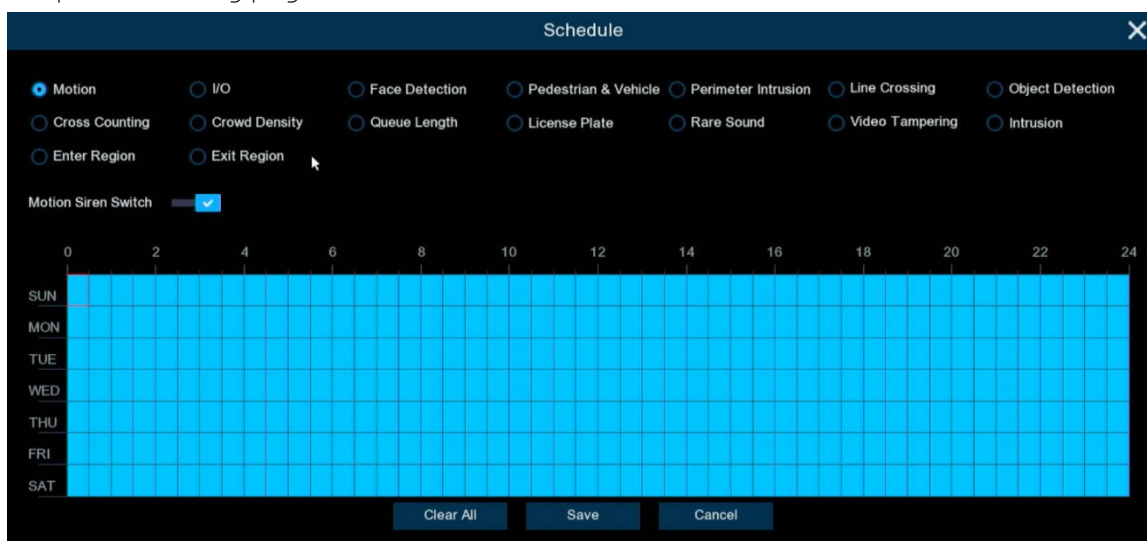

If a channel is selected in the schedule, it indicates that the channel can trigger siren alarms during the corresponding period.

You can set the siren linkage alarm and effective time of a function by selecting the corresponding function sub-tab and switch.

**Clear All:** Click this button to clear the selected status on all sub-tabs.

### 5.3.11 Alarm Disarm

After the one-Click Alarm disarm function is enabled, you can cancel the response of the device to various alarms. On this page you can set the relevant parameters including the disarming switch, channel, type, and schedule. **Note:** The Exception system alarms are not controlled by one-Click disarming.

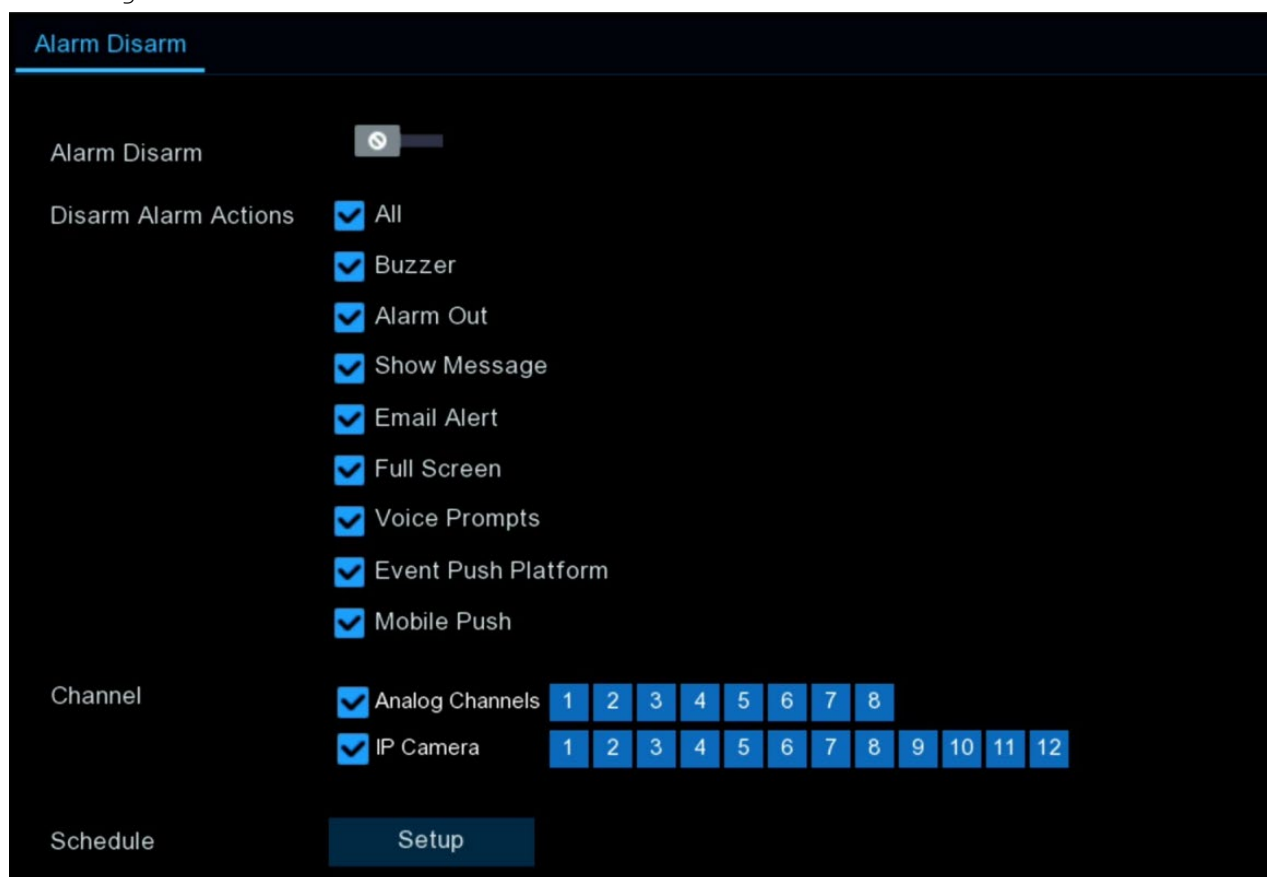

**Alarm Disarm:** Used to set whether to enable the one-Click disarming function.

**Disarm Alarm Action:** Used to set the alarm linkage types to be disarmed.

**All:** Select or clear all the types.

**Buzzer:** Used to set whether to enable the buzzer. When the one-Click disarming function is enabled, you can select this option to disable the buzzer.

**Alarm Out:** Used to set whether to enable external alarm output. When the one-Click disarming function is enabled, you can select this option to disable the external alarm device when an alarm is triggered.

**Show Message:** Used to set whether to display messages. When the one-Click disarming function is enabled, you can select this option to not display the alarm messages when motion is detected on the preview page.

**Email Alert:** Used to set whether to send emails. When the one-Click disarming function is enabled, you can select this option to make the NVR not automatically send an email when an alarm is triggered.

**Full Screen:** Used to set whether to display in full screen. When the one-Click disarming function is enabled, you can select this option to make the channel configured with full-screen mode not enter full screen mode on the preview screen when the channel triggers an alarm.

**Voice Prompts:** Used to set whether to enable voice prompts. When the one-Click disarming function is enabled, you can select this option to disable voice prompts when a channel configured with voice prompts triggers an alarm.

**Event Push Platform:** When the alarm is triggered, the device does not push the alarm information to the third-party platform

**Mobile Push:** When this menu is enabled, key disarming is open, check Mobile Push, when alarm is triggered, the device will not push the alarm information to the app.

**Channel:** Select the channels to be disarmed.

**Schedule:** Click the setup button to enter the schedule setup page.

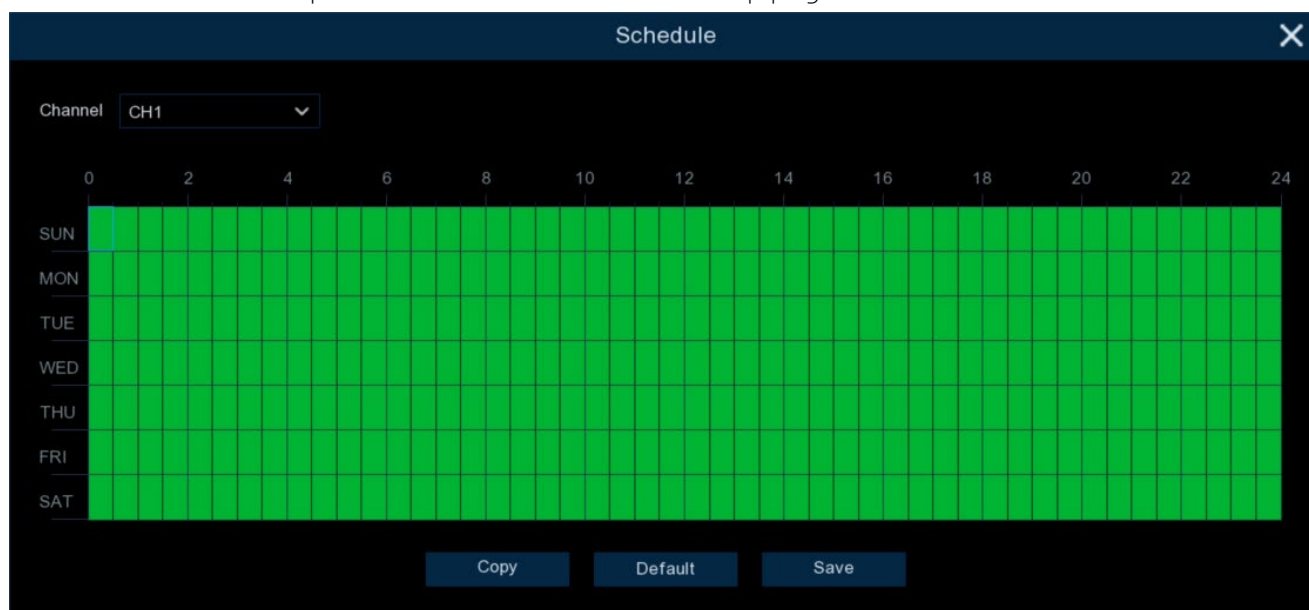

## 5.4 AI

### 5.4.1 Setup

#### 5.4.1.1 Face Detection

This menu allows you to set the parameters related to face detection. (Note: Enable the channel face detection function, you need to read and agree to the Face Recognition Service Agreement)

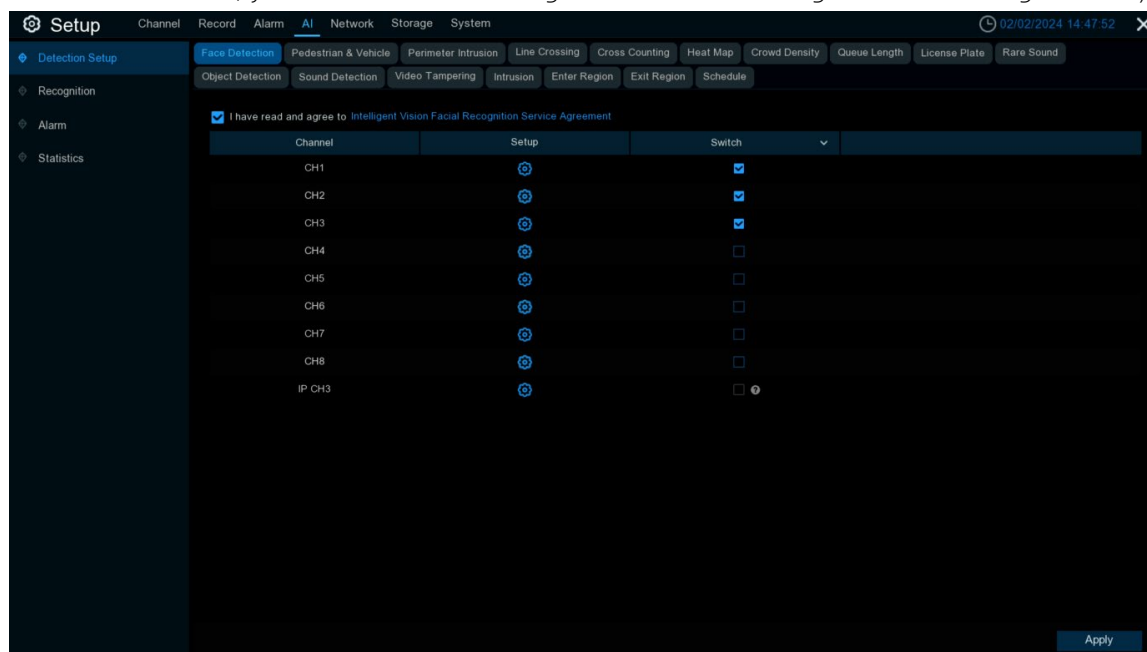

**Switch:** Tick the checkbox to enable the face detection.

**Setup:** Click setup button for further settings:

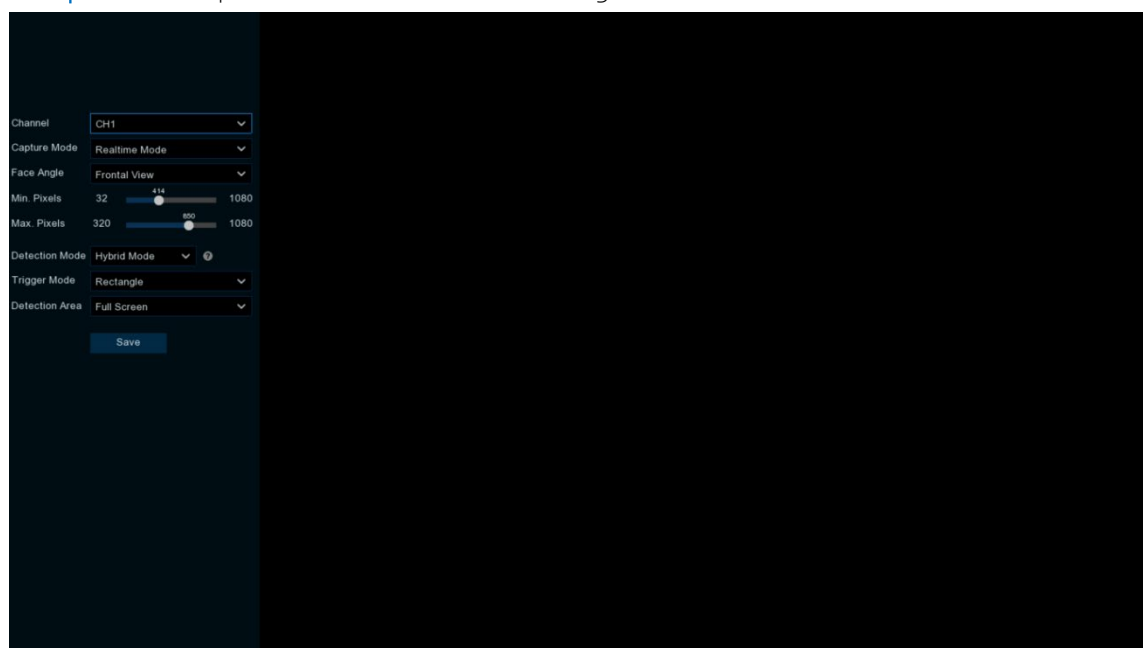

**Channel:** Select the channel you want to configure.

**Capture Mode:** Capture Mode. There are Optimal Mode (select a picture with the best quality to push during the time from when the face appears to when it disappears). Real-time mode (push once when the face appears and again when it disappears) and interval mode (customize the time and interval of the push).

**Snapshot Qty:** In interval mode, set the number of snapshots for face push.

**Capture Interval:** Set the frequency of face push in interval mode.

**Face Angle:** Set the angle of detection. there are positive face mode. multi-angle mode and custom angle mode.

**Roll Angle:** Set the range of face rotation under the customized angle.

**Pitch Angle:** Set the pitch range of the face in the customized angle.

**Yaw Angle:** Set the horizontal flip range of the face in the customized angle.

**Frontal view/Multi-angle:** Reset the angle settings to default to the Frontal and Multi -angle settings.

**Picture Quality:** Set the picture quality, 1 is the lowest, 100 is the highest.

**Min.Pixels:** Set the minimum recognized pixel frame. The face must be larger than the set pixels to be recognized.

**Max.Pixels:** Set the maximum pixel frame. Pixels: Set the maximum pixel frame that a face must be smaller than the set number of pixels to be recognized.

**Face Enhance:** Face enhancement makes it easier to recognize the moving faces, but it may lower the whole picture quality.

**Face Attribute:** Enable this function to detect gender, age, mask, glasses and facial expression.

**Detection Mode:** There are two modes of detection: Hybrid and Motion.

**Hybrid Mode:** Both static and moving targets are detected. Setting the motion mode can reduce false alarms.

**Motion Mode:** Only moving targets in the frame are detected.

**Trigger Mode:** Rule type. There are rectangle and line rules.

**Detection Area:** Under Rectangle rule, set the detection area. User-default full screen area.

**Rule Type:** Under Line Rule, set the rule for line crossing. You need to draw a line inside the right preview. When the face crosses the line according to the set rule A->B or B->A, it will be detected.

**Bounding Box:** When this menu is enabled, the target detection box is displayed in the live screen.

### 5.4.1.2 Pedestrian & Vehicle

When pedestrian beings and/or vehicles are detected, your DVR will activate recording, and it will also send an alarm.

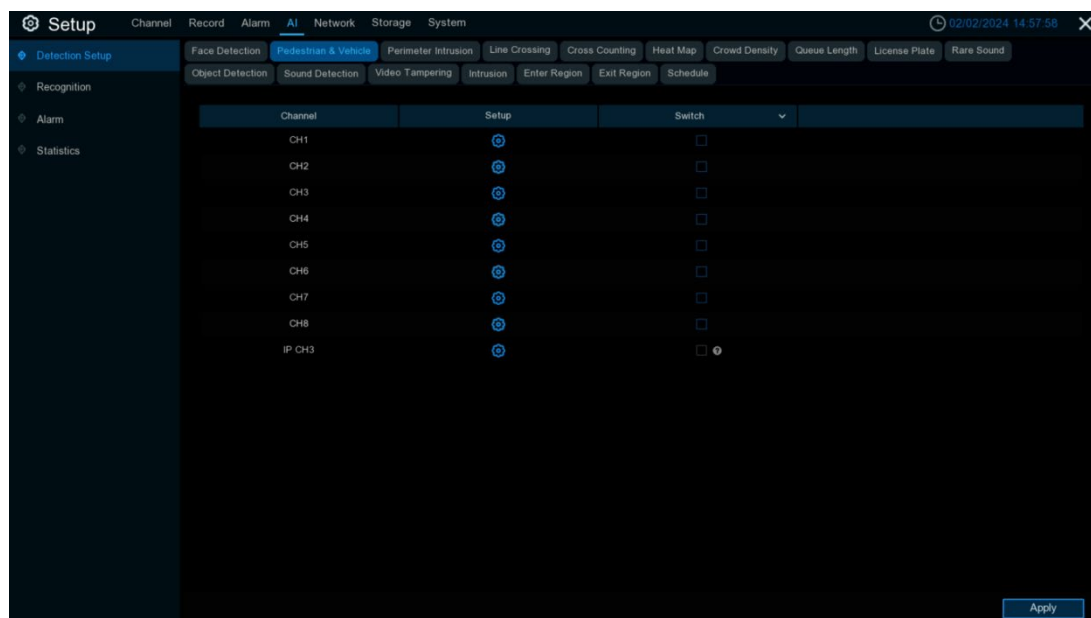

**Switch:** Tick the checkbox to enable the human & vehicle detection.

**Setup:** Click setup ⚙️ button for further settings:

**Level:** The sensitivity level is Low Medium High. Higher sensitivity will make it easier to trigger a detection (this option is only shown when accessing IP cameras that support Intelligent)

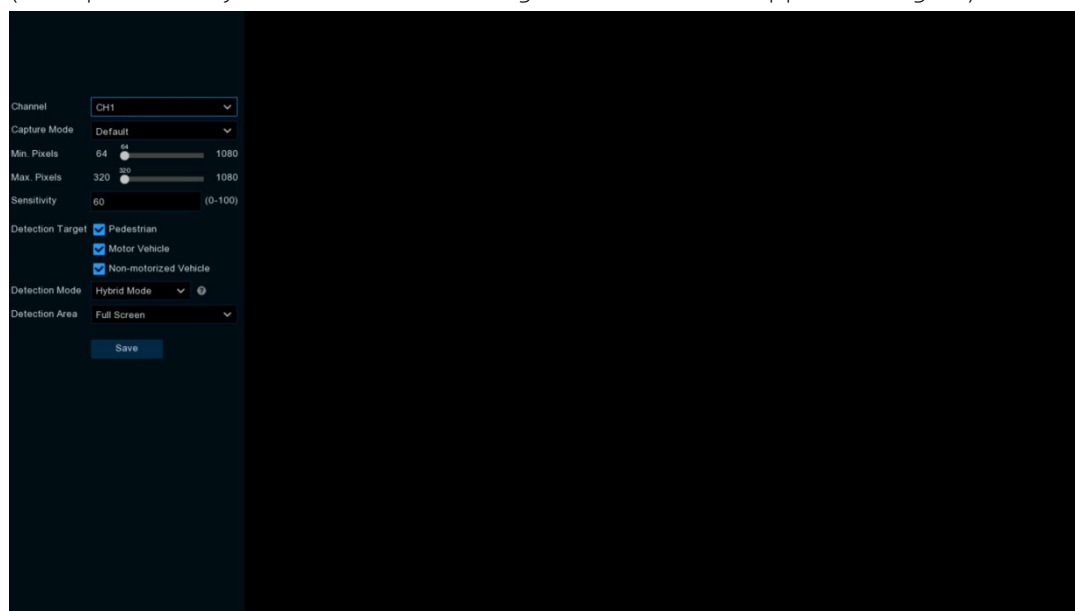

**Channel:** Select the channel you want to configure.

**Capture Mode:** Capture Mode. There are Optimal Mode (The time between the appearance of the pedestrian & Vehicle and its disappearance, select a picture with the best quality to push during the time



from when the face appears to when it disappears). Real-time mode (push once when the face appears and again when it disappears) and interval mode (customize the time and interval of the push).

**Snapshot Qty:** In interval mode, set the number of snapshots for pedestrian & Vehicle push.

**Capture Interval:** in interval mode. Set the frequency of pedestrian & Vehicle push.

**Min. pixels:** Set the minimum pixel frame to be recognized. The pedestrian & Vehicle must be larger than the set number of pixels to be recognized.

**Max pixels:** Set the max pixels frame. Pedestrian & Vehicle must be smaller than the set pixels to be recognized.

**Sensitivity:** Set the sensitivity, the range is 1-100, the larger the value, the easier to trigger.

**Detection Target:** Set the detection target, you can choose pedestrian , motorized, non-motorized or all types.

**Detection Mode:** There are two modes of detection: Hybrid and Motion.

**Hybrid Mode:** Both static and moving targets are detected. Setting the motion mode can reduce false alarms.

**Motion Mode:** Only moving targets in the frame are detected.

**Detection Area:** Under Rectangle rule, set the detection area. User-default full screen area.

**Bounding Box:** When this menu is enabled, the target detection box is displayed in the live screen.

**Auto PTZ Tracking:** Auto tracking switch (supported by some camera models).

### 5.4.1.3 Perimeter Intrusion

Perimeter Intrusion Detection feature detects people, vehicles or other objects entering or exiting a predefined virtual area and takes certain specific measures when an alarm is triggered.

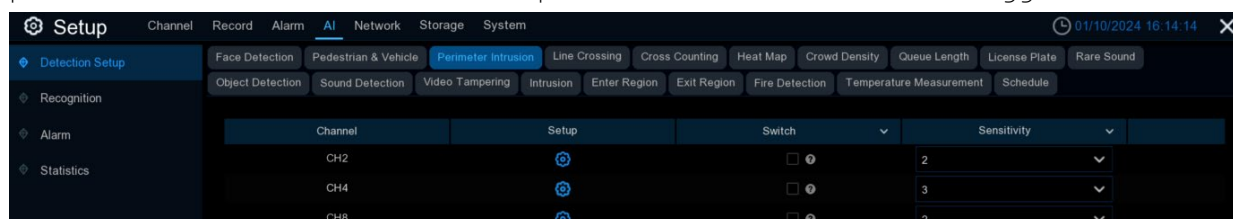

**Switch:** Enable or disable the Perimeter Intrusion

**Sensitivity:** Sensitivity levels are from 1 to 4. Higher sensitivity will trigger detection more easily.

**Setup:** Click to configure the detection conditions.

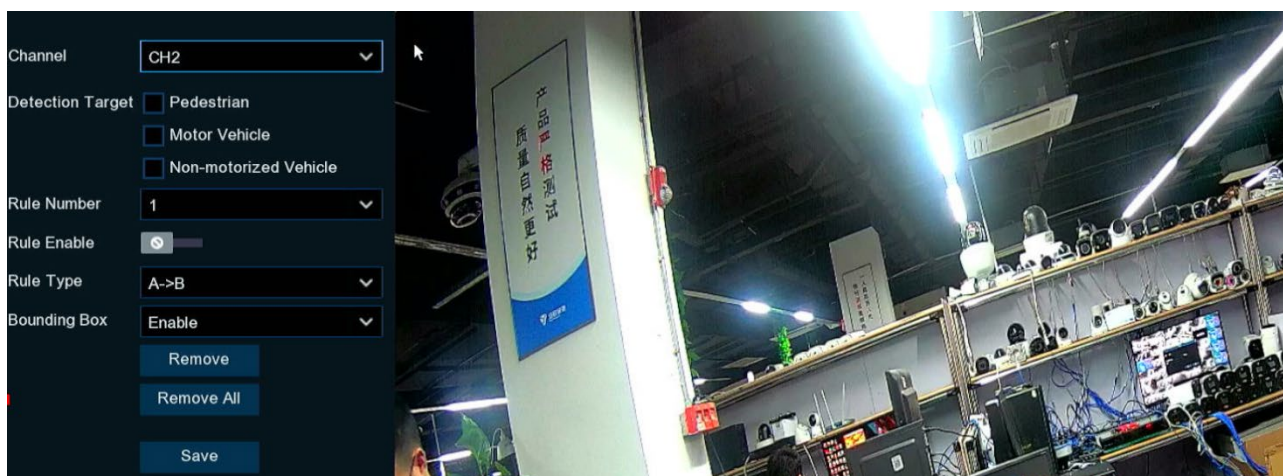

**Channel:** Select the channel you want to configure.

**Detection Type:** Detection type.

**Person:** Trigger when pedestrian triggers perimeter intrusion.

**Motor Vehicle:** Alarm is triggered by a motorized vehicle.

**Non-motorized Vehicle:** Alarm is triggered by a non-motorized vehicle.

**Rule Number:** It is the number of perimeter intrusion. area. Maximum 4 areas you can set for perimeter intrusion function.

**Rule Enable:** Enable the detection in Rule Switch.

**Rule Type:**

A→B: Camera will only detect the action from side A to side B.

B→A: Camera will only detect the action from side B to side A.

A↔B: Camera will detect the action from either side B to side A or side A to side B.

Use your mouse to Click 4 points in the camera image to draw a virtual region. The shape of the region should be a convex polygon. Concave polygon will be not able to save.

Click **Save** to save your settings.

If you want to modify the position or range of the rule. Please Click the red box in the line and the color of the line will change to red. Press and hold the left mouse button to move the line or drag the endpoints to modify the length or position of the line.

If you want to delete a rule from the camera picture. Click on the red box in the line and then click on the **"Remove"** button. Click on **"Remove All"** will remove all lines.

**Bounding Box:** When this menu is enabled, the target detection box is displayed in the live screen.

**Note:**

- 1)The perimeter should not be too close to the edges/corners of the camera image as it may not trigger detection when a target passes through the edge/corner.
- 2)The shape of the area should not be too narrow/small because it may not be able to trigger detection when a large target passes through the perimeter.

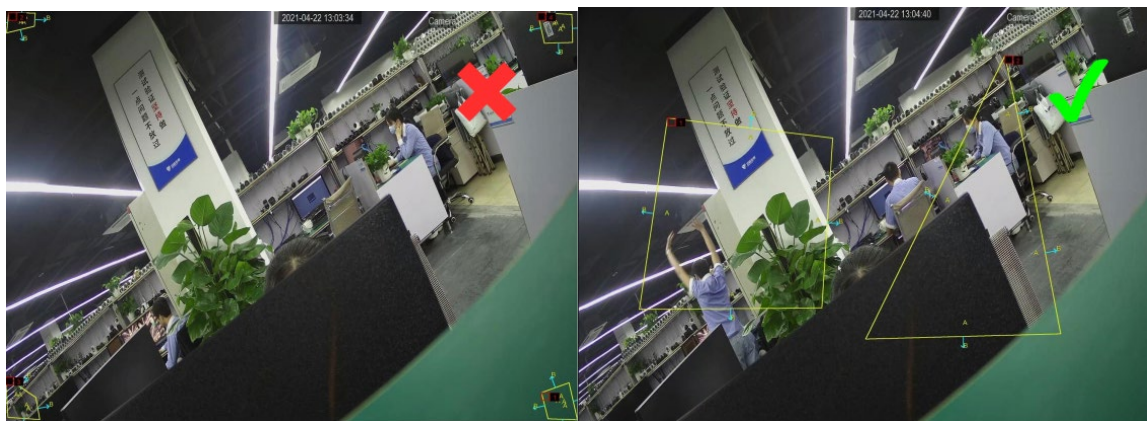

### 5.4.1.4 Line Crossing

Line Crossing Detection feature detects people, vehicles or other objects that cross a predefined virtual line and takes certain specific measures when an alarm is triggered.

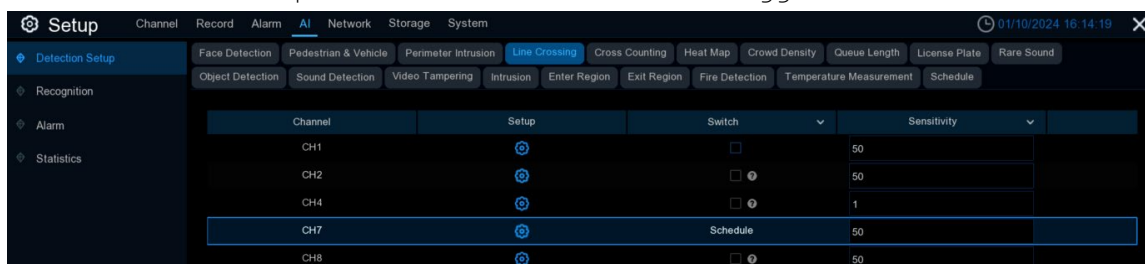

**Switch:** Enable or disable the Line Crossing Detection.

**Sensitivity:** Sensitivity levels are from 1 to 4. Higher sensitivity will trigger detection more easily.

**Setup:** Click to configure the detection conditions.

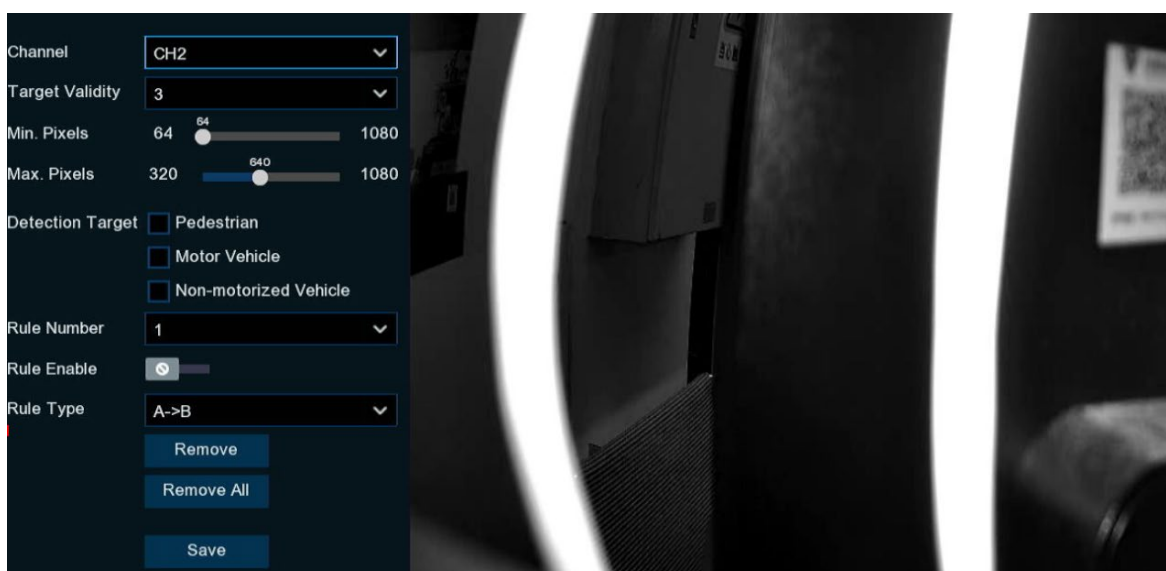

**Channel:** Select the channel you want to configure.

**Detection Type:** Detection type.

**Person:** Trigger when pedestrian triggers perimeter intrusion.

**Motor Vehicle:** Alarm is triggered by a motorized vehicle.

**Non-motorized Vehicle:** Alarm is triggered by a non-motorized vehicle.

**Rule Number:** It is the number of perimeter intrusion. area. Maximum 4 areas you can set for perimeter intrusion function.

**Min. pixels:** Set the minimum pixel frame to be recognized. The pedestrian & Vehicle must be larger than the set number of pixels to be recognized.

**Max pixels:** Set the max. pixels frame. pedestrian & Vehicle must be smaller than the set pixels to be recognized.

**Rule Enable:** Enable the detection in Rule Switch.

**Rule Type:**

A→B: Camera will only detect the action from side A to side B.

B→A: Camera will only detect the action from side B to side A.

A↔B: Camera will detect the action from either side B to side A or side A to side B.

Use your mouse to Click 2 points in the camera image to draw a virtual line.

Click **Save** to save your settings.

If you want to modify the position or range of the rule. Please Click the red box in the line and the color of the line will change to red. Press and hold the left mouse button to move the line or drag the endpoints to modify the length or position of the line.

If you want to delete a rule from the camera picture. Click on the red box in the line and then click on the **"Remove"** button. Click on **"Remove All"** will remove all lines.

**Bounding Box:** When this menu is enabled, the target detection box is displayed in the live screen.

**Notice.**

- 1) The line should not be set too close to the edge of the camera image so that it fails to trigger an alarm when a target crosses the camera.
- 2) The line should not be set too short so that it fails to trigger an alarm when a target crosses the camera.

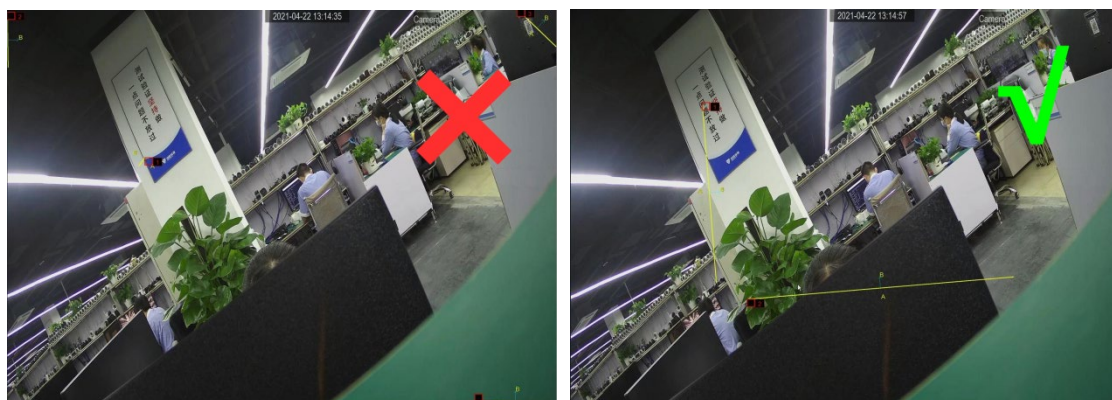

### 5.4.1.5 Cross Counting

Crossing count function counts people, motorized vehicles, non-motorized vehicles, or moving objects that cross the virtual line.

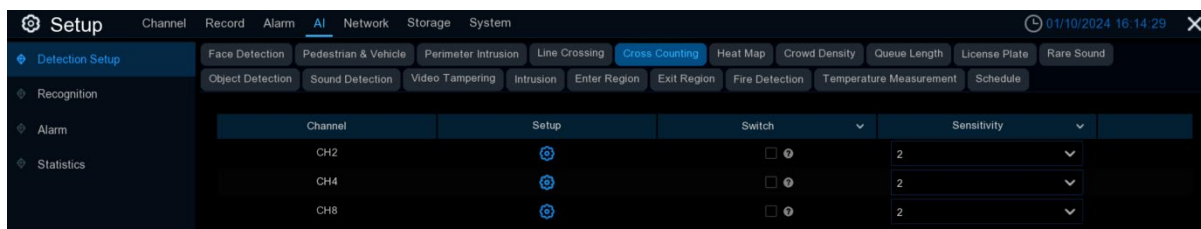

**Switch:** Enable or disable the cross-counting function.

**Sensitivity:** Sensitivity levels are from 1 to 4. Higher sensitivity will trigger detection more easily.

**Setup:** Click to configure the detection conditions.

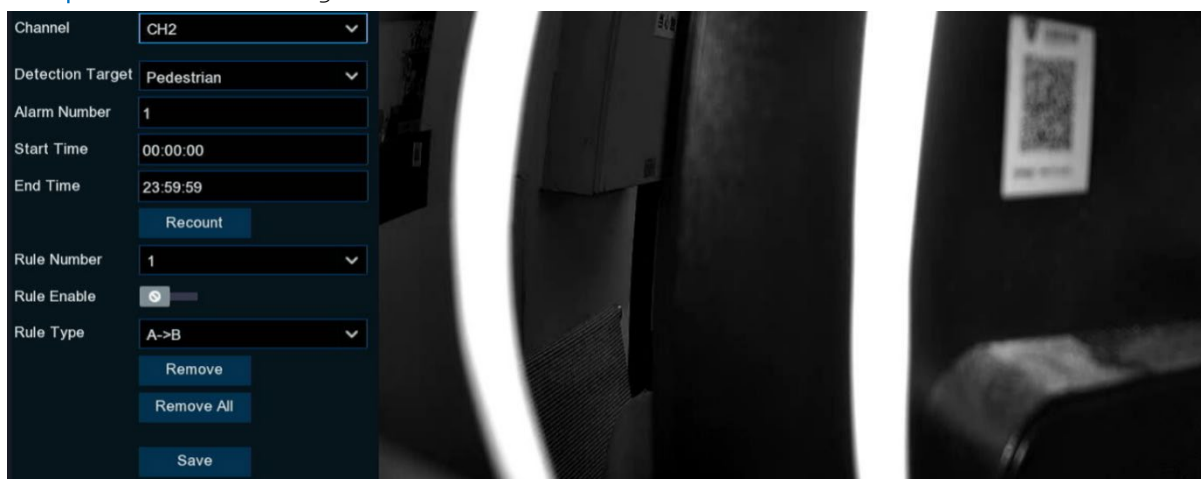

**Channel:** Select the channel you want to configure.

**Detection type:**

**Motion:** All moving subjects will be Counting by the system

**Pedestrian:** Only human beings will be Counting

**Motor Vehicle:** Only motor Vehicle beings will be Counting

**Non-motorized Vehicle:** Only Non-motorized vehicles will be Counting .

**Alarm Number:** Set the number of alarms. alarm Num = (number of cross in) - (number of cross out).

E.g. the number of entries is 601 while the number of exits is 400, and the alarm number you set is 200,  $601 - 400 = 201 > 200$ , then the DVR will send an alert.

**Start Time:** Set the counting start time.

**End Time:** Set the end time of counting.

**Recount:** Clear the count to zero and recount.

**Rule Number:** Select the rule number. The number of virtual lines on which Crossing count can be drawn. Maximum 1 line.

**Rule Enable:** Enable the detection rule in the rule switch.

**Rule Type:**

a) A->B, DVR will count the people or objects from side A to side B.

b) B->A, DVR will count the people or objects from side B to side A.

Click Save to **save** the settings.

If you want to modify the position or range of the rule. Please Click the red box in the line and the color of the line will change to red. Press and hold the left mouse button to move the line or drag the endpoints to modify the length or position of the line.

If you want to delete a rule from the camera picture. Click on the red box in the line and then click on the **"Remove"** button. Click on **"Remove All"** will remove all lines.

Note:

- 1) The rule line should not be too close to the edge of the camera image so as not to fail to trigger an alarm if the target crosses the line.
- 2) The rule line should be located in the area accessible to the detected object.
- 3) The rule line should not be set too short so as not to trigger the Trigger when the target crosses the line.



### 5.4.1.6 Heat Map

A graphical representation of the areas of the page that visitors are passionate about and the geographic areas where visitors are located in a specially highlighted format, the heat map also shows which areas of the screen are attracting the majority of visitors.

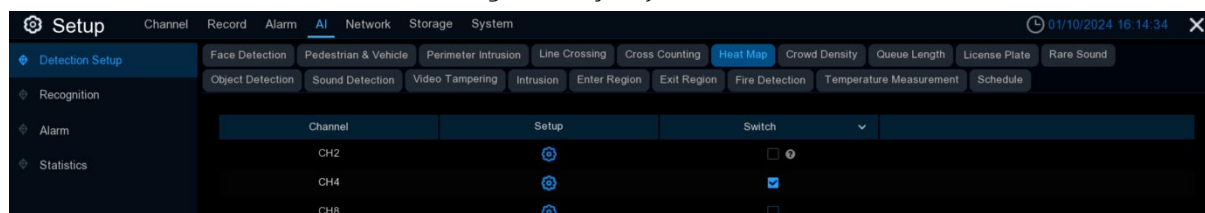

**Switch:** Enable or disable the heat map function.

**Setup:** Click to configure the detection area.

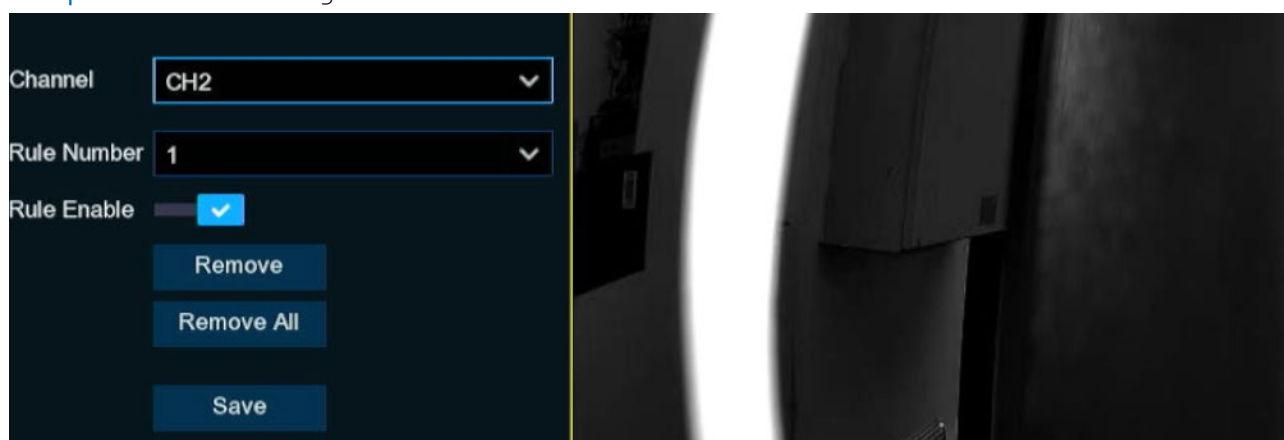

**Channel:** Select the channel you want to configure.

**Rule Number:** Select the rule number. The heat map function can only be set for 1 area.

**Rule Enable:** Enable detection in Rule Switch.

**Remove:** Check the box of detection area, click Remove to remove the detection box.

**Remove All:** Click Remove All to remove the detection box.

### 5.4.1.7 Crowd Density

Crowd density detection is based on face detection technology, which is used to detect crowd gathering to maintain a controllable order in certain area. When the total number of detected people in a certain area exceeds the preset allowed number, the system will send an alert.

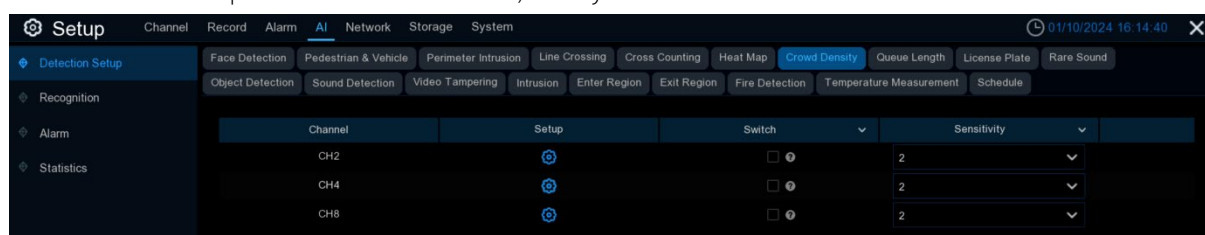

**Switch:** Enable or disable the cross-counting function.

**Sensitivity:** Sensitivity levels are from 1 to 4. Higher sensitivity will trigger detection more easily.

**Setup:** Click  to configure the detection conditions.

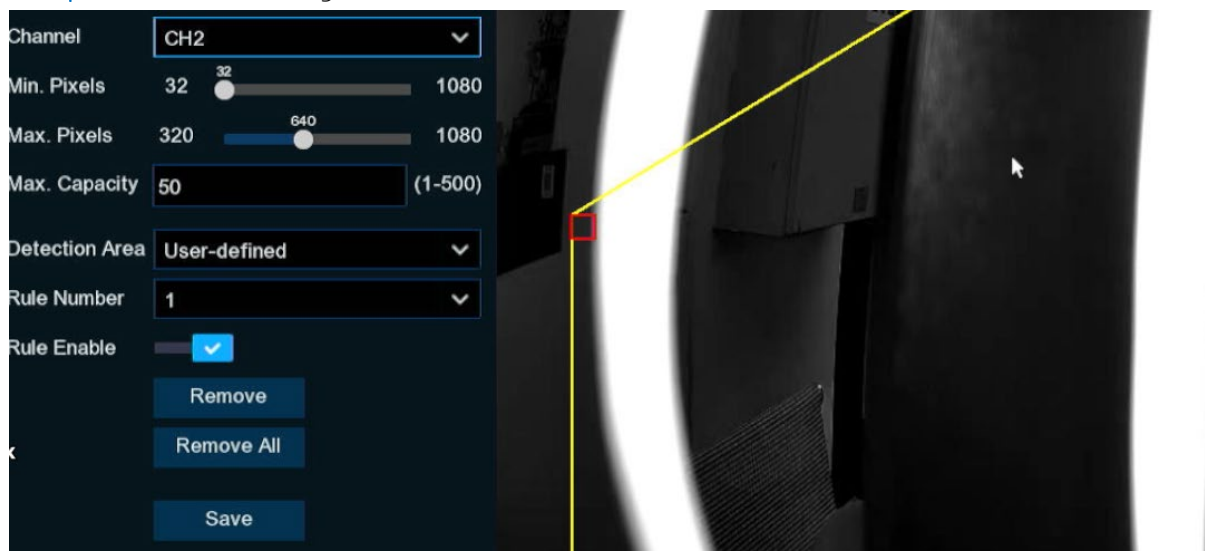

**Channel:** Select the channel you want to configure.

**Min pixel:** Set the min recognized pixel frame. Pedestrian must be larger than the set pixel to be recognized.

**Max pixel:** Set the max pixel frame to be recognized. Pedestrian must be smaller than the set pixel to be recognized.

**Max capacity:** If the number of people in the detection area exceeds the maxi capacity, the DVR will sound an alarm.

**Detection Area:** Set the detection range, Full Screen or User-defined.

If you select User-defined. Range, you will need to use the mouse to Click on the 8 points in the camera image to draw a virtual area.

**Rule Number:** Select the rule number. The Crowd Density function can only be set for 1 area.

**Rule Enable:** Enable detection in Rule Switch.

Click Save to save the settings.

If you want to modify the position or sharpness of the area, click on the red box in the area and the border of the area will be changed to red. Click and hold down the left mouse button to move the position of the region, or drag the corner points to resize the region.

If you want to remove one of the regions from the camera picture, click the red box in the region and then click the Remove button. Click Remove All will remove all areas.



### 5.4.1.8 Queue Length

Queue length detection is used to detect the status of the queue, including queue length and stall time.

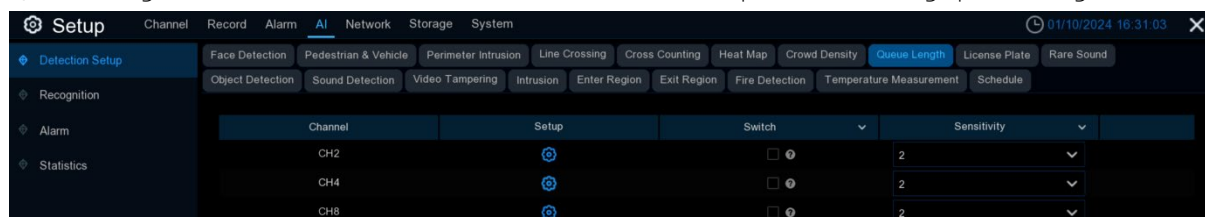

**Switch:** Enable or disable the cross-counting function.

**Sensitivity:** Sensitivity levels are from 1 to 4. Higher sensitivity will trigger detection more easily.

**Setup:** Click to configure the detection conditions.

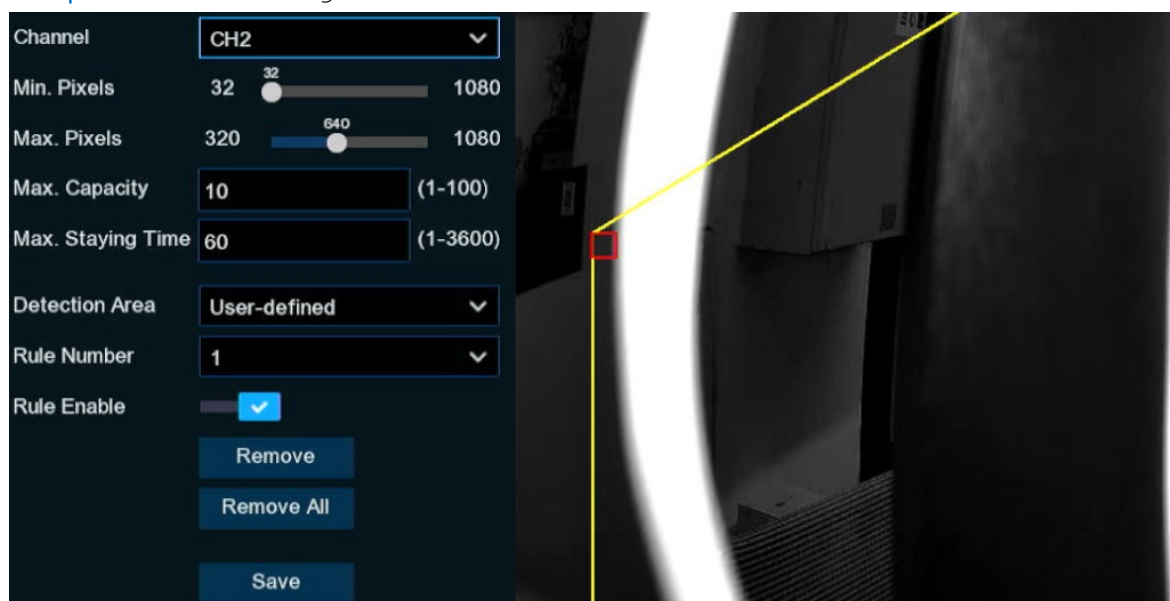

**Channel:** Select the channel you want to configure.

**Min pixel:** Set the min recognized pixel frame. Pedestrian must be larger than the set pixel to be recognized.

**Max pixel:** Set the max pixel frame to be recognized. Pedestrian must be smaller than the set pixel to be recognized.

**Max capacity:** If the number of people in the queue in the detection area exceeds the maximum number of detectors, the DVR will send an alarm.

**Max Staying Time:** If the queue stays longer than the given processing time in seconds, the DVR will send an alarm.

**Detection Area:** Set the detection range, Full Screen or User-defined.

If you select User-defined. Range, you will need to use the mouse to Click on the 8 points in the camera image to draw a virtual area.

**Rule Number:** Select the rule number. The Queue Length function can only be set for 1 area.

Click Save to save the settings.

**Rule Enable:** Enable detection in Rule Switch.

If you want to modify the position or sharpness of the area, click on the red box in the area and the border of the area will be changed to red. Click and hold down the left mouse button to move the position of the region, or drag the corner points to resize the region.

If you want to remove one of the regions from the camera picture, click the red box in the region and then click the **Remove** button. Click **Remove All** will remove all areas.

### 5.4.1.9 License Plate

License plate detection function, by detecting the license plate of passing vehicles. Identify whether the vehicle is an unfamiliar vehicle or a vehicle that has been entered into the database. Also can be unfamiliar vehicle license plate information back up to the database, and access to the license plate detection alarm information for video playback. Currently, license plate detection only supports from Europe license plate and America license plates.

In this menu, you can set the parameters of license plate detection.

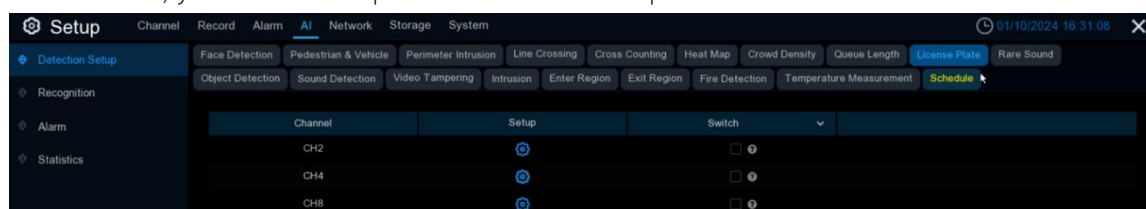

**Switch:** Enable or disable the License Plate detection function.

**Setup:** Click to configure the detection condition.

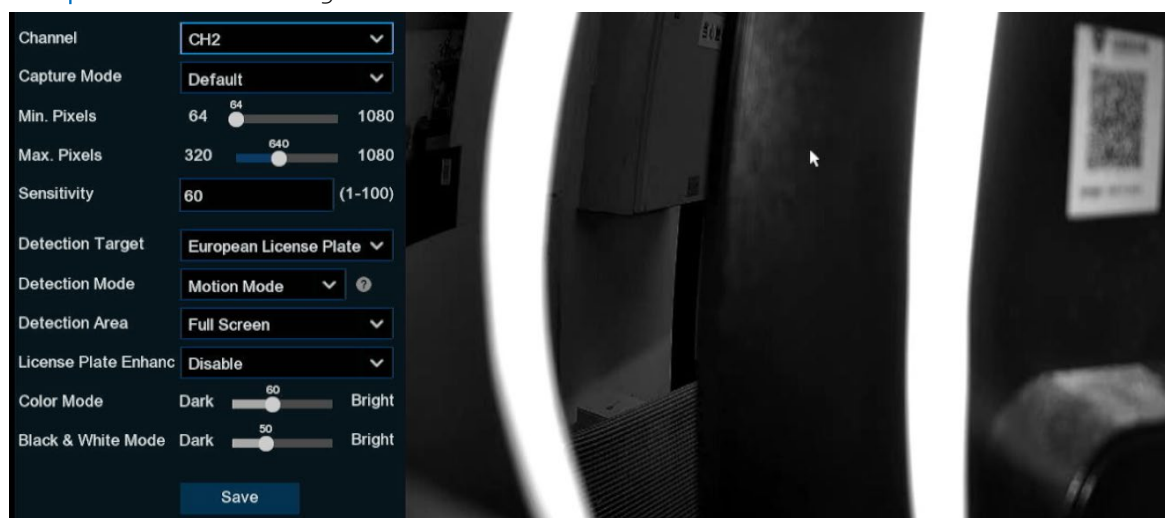

**Capture Mode:** Capture Mode. There are Optimal Mode (select the best quality image to be pushed from the time the license plate of the vehicle appears to the time it disappears). Real-time mode (push once when the license plate appears and again when it disappears) and Interval mode (customize the number of captures to be pushed and the time interval between them).

**Capture Num:** In interval mode, set the number of license plate captures to be pushed.

**Snapshot Qty:** in interval mode, set the frequency of license plate snapshots.

**Min pixel:** Min pixel frame, the license plate must be larger than the set min pixel to be recognized.

**Max pixel:** Maxi pixel frame, the license plate must be smaller than the set maxi pixel in order to be recognized.

**Sensitivity:** The larger the value, the easier it is to detect the target.

**Detection Target:** The type of license plate to be detected, there are two types as below:

**European license plate:** European license plate.

**American license plate:** American license plate.

**Detection Mode:** license plate detection mode, there are two types as below:

**Hybrid Mode:** detect static license plate and dynamic vehicles in the screen.

**Motion Mode:** only detect the license plate during motion.

**Detection Area:** Set the area for license plate detection, there are two kinds as follows:

**Full Screen:** full screen detection.

**User-defined:** customize the detection area.

**License plate Enhance:** Enable/disable license plate enhance.

**Color Mode:** Apply to full color scene, the higher the value, the brighter the screen, the lower the value, the darker the screen, the value can be set from 0-255.

**Black&White Mode:** Apply to black & white scene, the higher the value the brighter the picture is, the lower the value the darker the picture is, the value can be set in the range of 0-255.

**Note:** When the License Plate Detection function is enabled, if License plate enhance is also enabled, the image brightness of the camera can be adjusted in accordance with the configured level value. Meanwhile, the device automatically adjusts its day time level or nighttime level in accordance with whether the camera is enabled with IR mode. The two application scenarios are independent of each other.

To use License plate enhance, you need to set **Exposure Compensation** to **Disable** and set **Shutter** to **Auto** on the image control page. After License plate enhance is enabled, **Time Exposure** cannot be modified.

### 5.4.1.10 Rare Sound

With the Rare Sound Detection function, it will alert you when your DVR detects abnormal sound, like baby crying, dog barking, and gunshot, and some certain actions can be taken when the alarm is triggered.

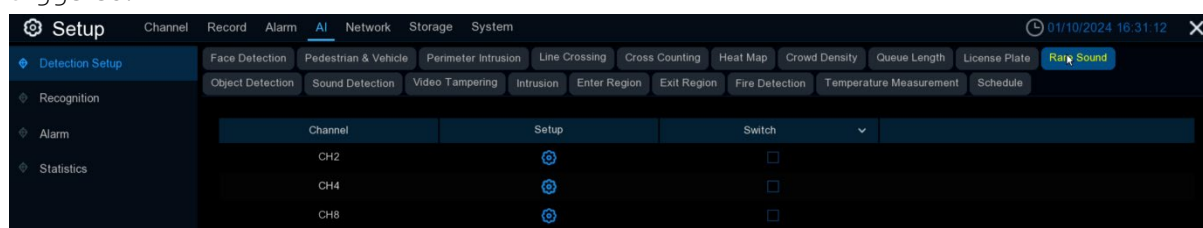

**Switch:** Tick the checkbox to enable the detection.

**Setup:** Click  to configure the detection condition.

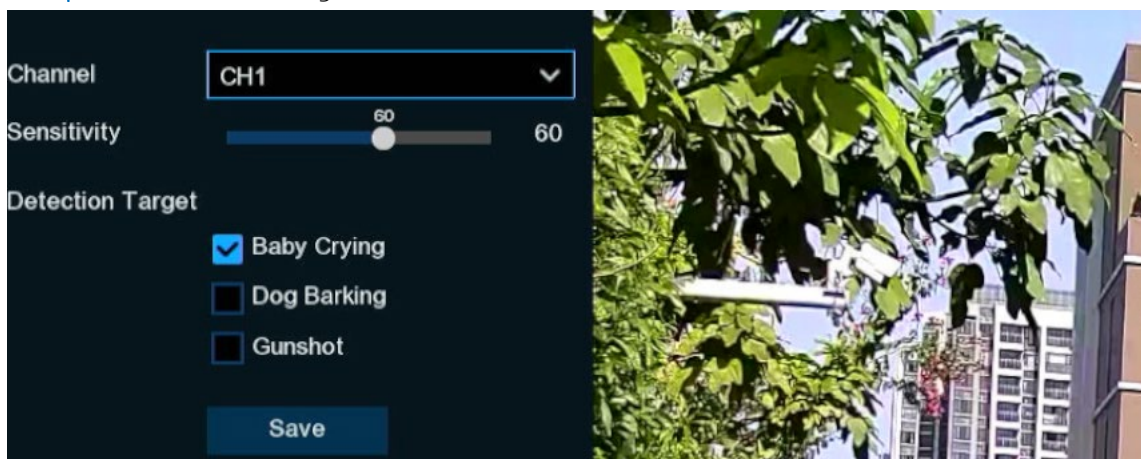

**Channel:** Select an available to configure.

**Sensitivity:** Sensitivity, the minimum default value is 1, the maximum default value is 100.

#### Detection Target

**Baby Crying:** Check the box to detect baby crying sound.

**Dog Barking:** Check the box to detect the dog barking sound.

**Gunshot:** Check the box to detect gunshot sound.

### 5.4.1.11 Object Detection

Object Detection function detects the objects left over or lost in the pre-defined region, such as the baggage, purse, dangerous materials, etc., and a series of actions can be taken when the alarm is triggered.

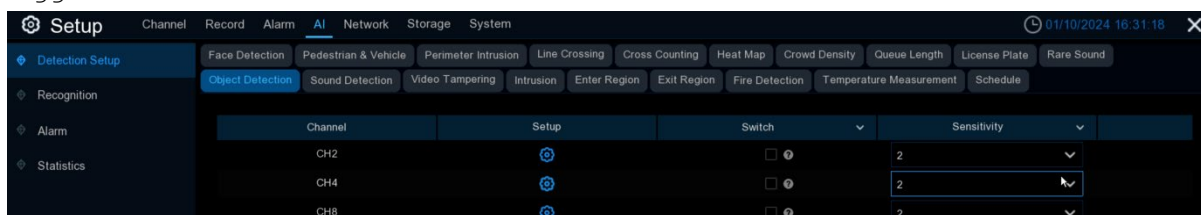

**Switch:** Check the box to enable object Detection function.

**Sensitivity:** Parameter range 1~4, default value 2, higher sensitivity will be easier to trigger detection. At the same time, the more false detection, the corresponding leakage will be reduced, it is recommended to keep the default value.

**Setup:** Click  to configure the detection condition.

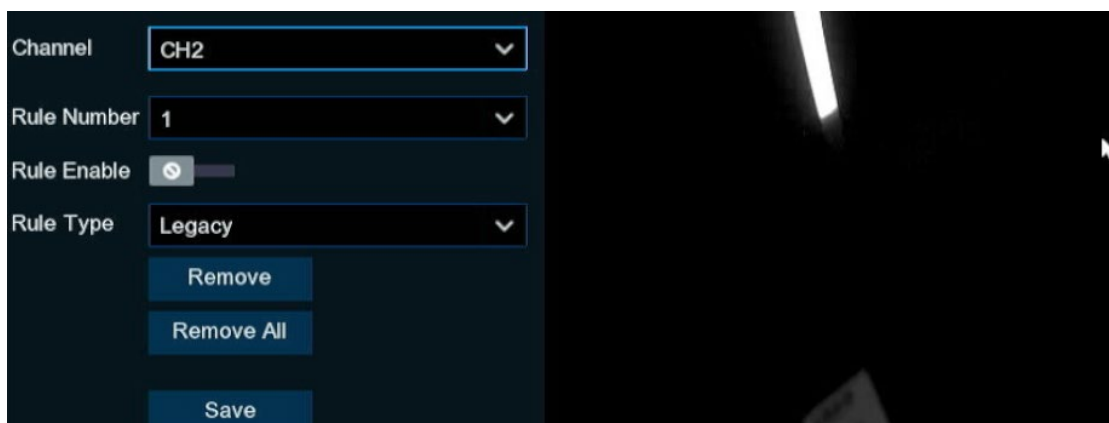

**Channel:** Select an available to configure.

**Rule Number:** You can set four rules in total. Draw the rule area on the area map and tap to the first rule. The Rule Switch and Rule Type of each rule are independent and need to be turned on, off or set separately.

**Rule Enable:** Enable detection in Rule Switch.

**Rule Type:** Select the rule type.

**Legacy:** DVR will only detect items that are left behind.

**Lost Lost:** DVR will only detect lost items.

**Legacy and Loss:** the DVR will detect both legacy and lost items.

Click with the mouse on the 4 points in the camera picture to draw a virtual region. The area's should be convex polygons. Concave polygons will not be saved.

**Bounding Box:** When this menu is enabled, the target detection box is displayed in the live screen.

Click **Save** to save your settings.

If you want to adjust the size of the region, click the red box in the region, the borders of the region will be changed to red color. Long press the left button of your mouse to move the whole region, or drag the corners to resize the region.

If you want to remove one of the regions from the camera image, click the red box in the region and then click **Remove** button. Click **Remove All** will delete all regions.

**Note:**

- 1) The detection area should be larger or equal to the size of the detected object, e.g. blue bottle detection.
- 2) The detected object should not be obscured.

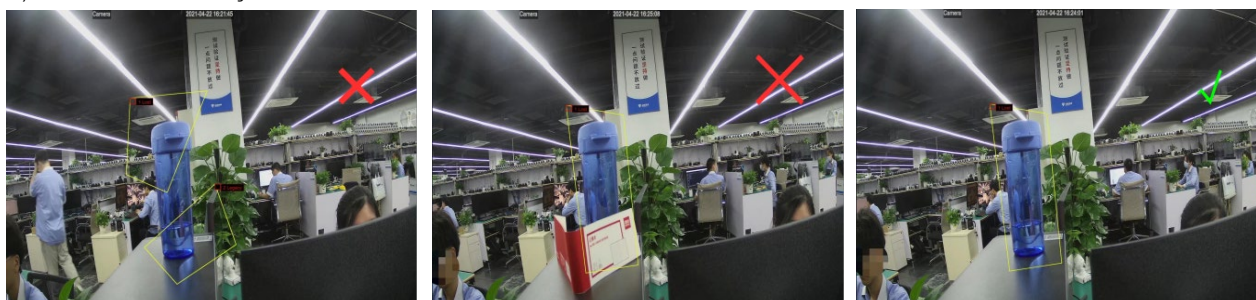

### 5.4.1.12 Sound Detection

By sound detection. The alarm can be triggered by detecting the rise or fall of the sound, and certain actions are performed when the alarm is triggered.

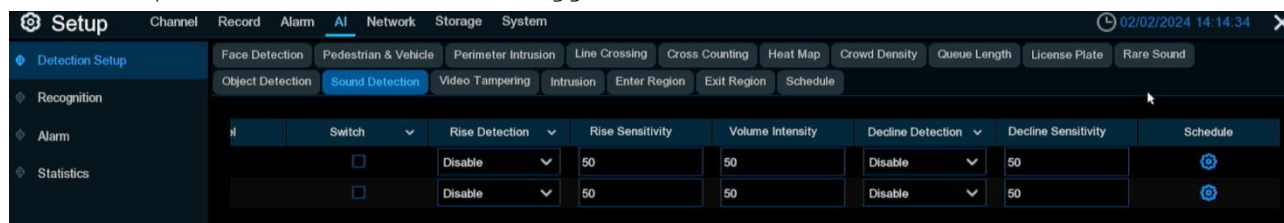

**Switch:** enable or disable sound detection.

**Rise Detection:** Enable or disable sound rise.

**Rise Sensitive:** trigger sound rise sensitivity, sensitivity can be set to 1-100, the larger the value, the higher the sensitivity of the sound rise.

**Volume Intensity:** Set the intensity of the triggered sound alarm, can be set from 1-100.

**Decline Detection:** Enable or disable sound decline.

**Decline Sensitive:** Trigger sound decline sensitivity, sensitivity can be set to 1-100, the larger the value, the higher the sensitivity of the sound decline.

**Schedule:** Set the time schedule for Sound Detection, default is all on, user can customize the time period for sound alarm.

Click the **"Alarm"** button to configure the sound alarm function.

### 5.4.1.13 Video Tampering

Video Tampering detects the occlusion of camera images, and some certain actions can be taken when the alarm is triggered.

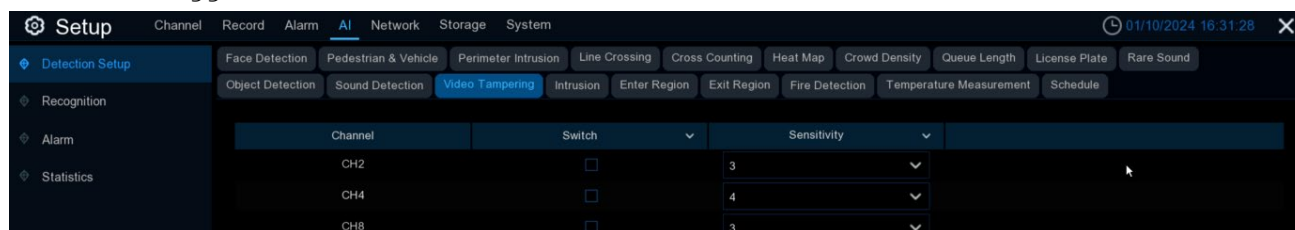

**Switch:** Enable or disable the function

**Sensitivity:** The sensitivity level is from 1 to 6, with a default value of 4. Higher sensitivity will be easier to trigger the detection.

Click the **"Alarm"** button to configure the Video Tampering function.

### 5.4.1.14 Intrusion

Intrusion detection. Can detect whether there is an object in the video to invade the set restricted area.  
Linkage alarm according to the judgment result.

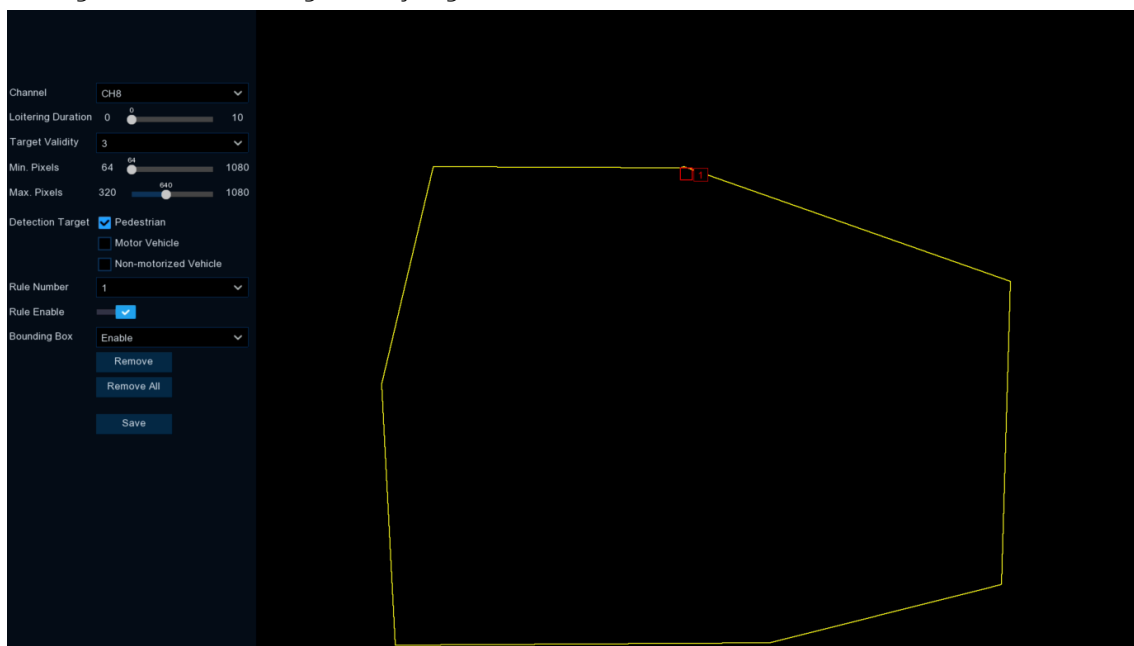

**Loitering Duration:** Indicates that the target enters the alert area and stays there for the duration of the time before generating an alarm. For example, if it is set to 5, the alarm will be triggered immediately after the target invades the area for 5s, and the maximum duration can be set to 10s.

**Target Validity:** The similarity between the detection target and the set detection type. The alarm is triggered only when the set similarity level is reached or exceeded. The higher the setting level the higher the similarity requirement, the more obvious the desired target characteristics and the higher the alarm accuracy. Levels can be set from 1 to 4. 1 represents a similarity of 80% or more, 2 represents a similarity of 60% or more, 3 represents a similarity of 40% or more, 4 represents a similarity of 20% or more.

**Min.Pixel:** Set the min recognized pixel. The target has to be larger than the set pixel to be recognized.

**Max.Pixel:** Set the max recognized pixel. The target has to be smaller than the set pixels to be recognized.

**Sensitivity:** The sensitivity setting for triggering area intrusion detection, the higher the sensitivity setting, the easier it is to trigger the alarm.

**Detection Target:** Setting the detection type.

**Pedestrian:** only intruding pedestrians are detected.

**Motorized:** only intruding motorized vehicles are detected.

**Non-Motorized:** only intruding non-motorized vehicles are detected.

**Don't Select Any Type:** all moving targets are detected.

**Rule Number:** Select the rule number, click the left mouse button in the right preview screen to draw the detection area connected with the first and last endpoints, and then click Save to complete the area

drawing. When you need to clear the warning area, click "Remove" to delete the selected area. Click "Remove All" to delete all areas.

**Rule Enable:** Enable detection in Rule Switch.

**Bounding Box:** When this menu is enabled, the target detection box is displayed in the live screen.

### 5.4.1.15 Enter Region

The entry area detection function can detect whether an object enters the set warning area and link the alarm according to the judgment result. The specific setting steps are shown below.

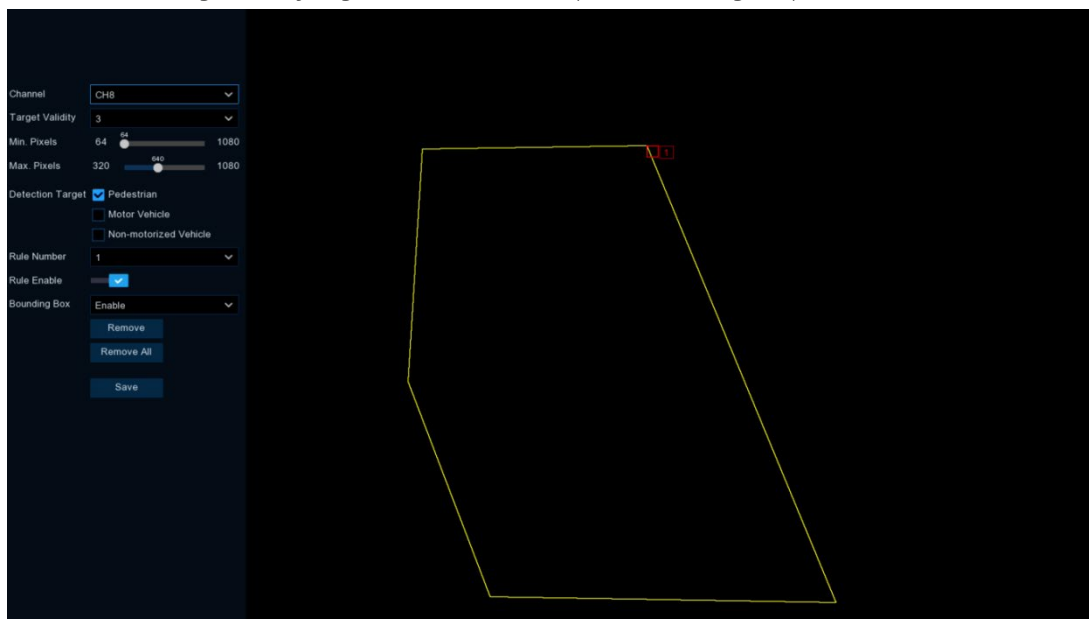

**Target Validity:** The similarity between the detection target and the set detection type. The alarm is triggered only when the set similarity level is reached or exceeded. The higher the setting level the higher the similarity requirement, the more obvious the desired target characteristics and the higher the alarm accuracy. Levels can be set from 1 to 4. 1 represents a similarity of 80% or more, 2 represents a similarity of 60% or more, 3 represents a similarity of 40% or more, 4 represents a similarity of 20% or more.

**Min.Pixel:** Set the min recognized pixel. The target has to be larger than the set pixel to be recognized.

**Max.Pixel:** Set the max recognized pixel. The target has to be smaller than the set pixels to be recognized.

**Sensitivity:** The sensitivity setting for triggering area enter region detection, the higher the sensitivity setting, the easier it is to trigger the alarm.

**Detection Target:** Setting the detection type.

**Pedestrian:** Only Enter Region pedestrians are detected.

**Motorized:** Only Enter Region motorized vehicles are detected.

**Non-Motorized:** Only Enter Region non-motorized vehicles are detected.

**Don't Select Any Type:** All moving targets are detected.



**Rule Number:** Select the rule number, click the left mouse button in the right preview screen to draw the detection area connected with the first and last endpoints, and then click **Save** to complete the area drawing. When you need to clear the warning area, click "Remove" to delete the selected area. Click "Remove All" to delete all areas.

**Rule Enable:** Enable detection in Rule Switch.

**Bounding Box:** When this menu is enabled, the target detection box is displayed in the live screen.

### 5.4.1.16 Exit Region

The leave area detection function detects whether an object has left the set warning area. According to the judgment result, the alarm is linked. Specific setup steps.

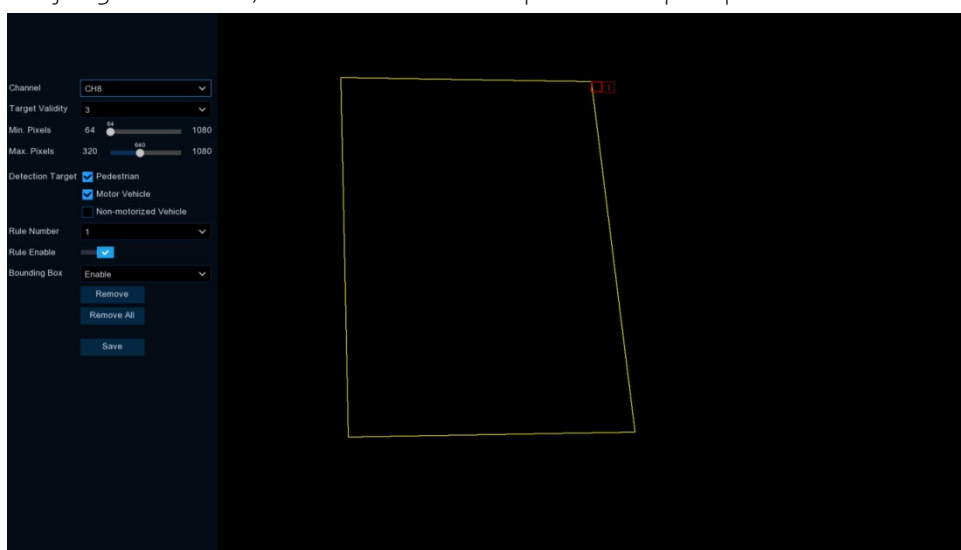

**Target Validity:** The similarity between the detection target and the set detection type. The alarm is triggered only when the set similarity level is reached or exceeded. The higher the setting level the higher the similarity requirement, the more obvious the desired target characteristics and the higher the alarm accuracy. Levels can be set from 1 to 4. 1 represents a similarity of 80% or more, 2 represents a similarity of 60% or more, 3 represents a similarity of 40% or more, 4 represents a similarity of 20% or more.

**Min.Pixel:** Set the min recognized pixel. The target has to be larger than the set pixel to be recognized.

**Max.Pixel:** Set the max recognized pixel. The target has to be smaller than the set pixels to be recognized.

**Sensitivity:** The sensitivity setting for triggering area exit region detection, the higher the sensitivity setting, the easier it is to trigger the alarm.

**Detection Target:** Setting the detection type.

**Pedestrian:** only Exit Region pedestrians are detected.

**Motorized:** only Exit Region motorized vehicles are detected.

**Non-Motorized:** only Exit Region non-motorized vehicles are detected.

**Don't Select Any Type:** all moving targets are detected.

**Rule Number:** Select the rule number, click the left mouse button in the right preview screen to draw the detection area connected with the first and last endpoints, and then click Save to complete the area drawing. When you need to clear the warning area, click "Remove" to delete the selected area. Click "Remove All" to delete all areas.

**Rule Enable:** Enable detection in Rule Switch.

**Bounding Box:** When this menu is enabled, the target detection box is displayed in the live screen.

### 5.4.1.17 Fire Detection ( need to connect a thermal camera)

To minimize fire point safety hazards, a fire point detection function is provided for areas where fire point safety hazards may exist.

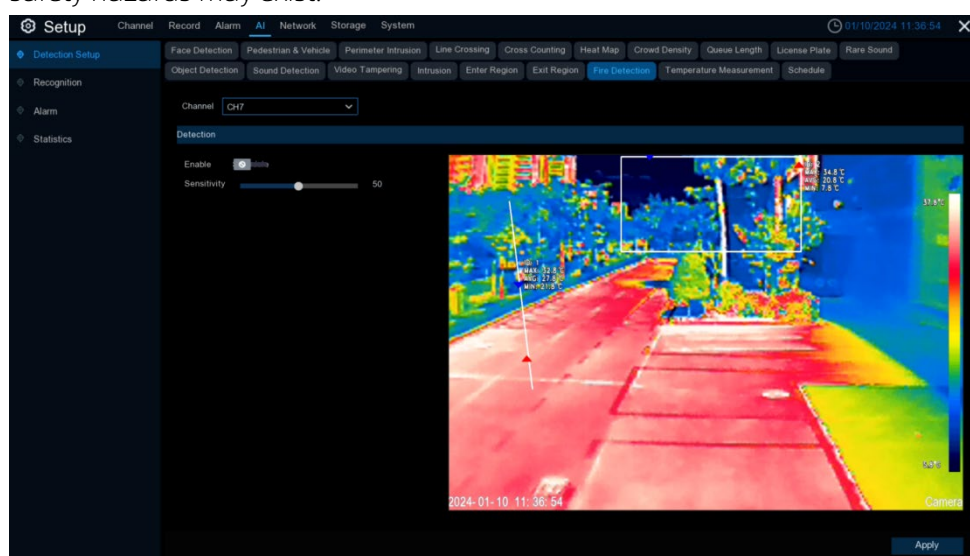

**Enable:** Enable or disable fire detection.

**Sensitivity:** Set the sensitivity of the fire detection. The lower the sensitivity, the higher the temperature at which the fire detection alarm should be triggered. The higher the sensitivity, the lower the temperature at which the fire detection alarm is triggered.

### 5.4.1.18 Temperature Measurement ( need to connect a thermal camera )

Used for real-time temperature monitoring of the monitoring place, when the temperature exceeds the alarm threshold, trigger the alarm to execute the linkage.

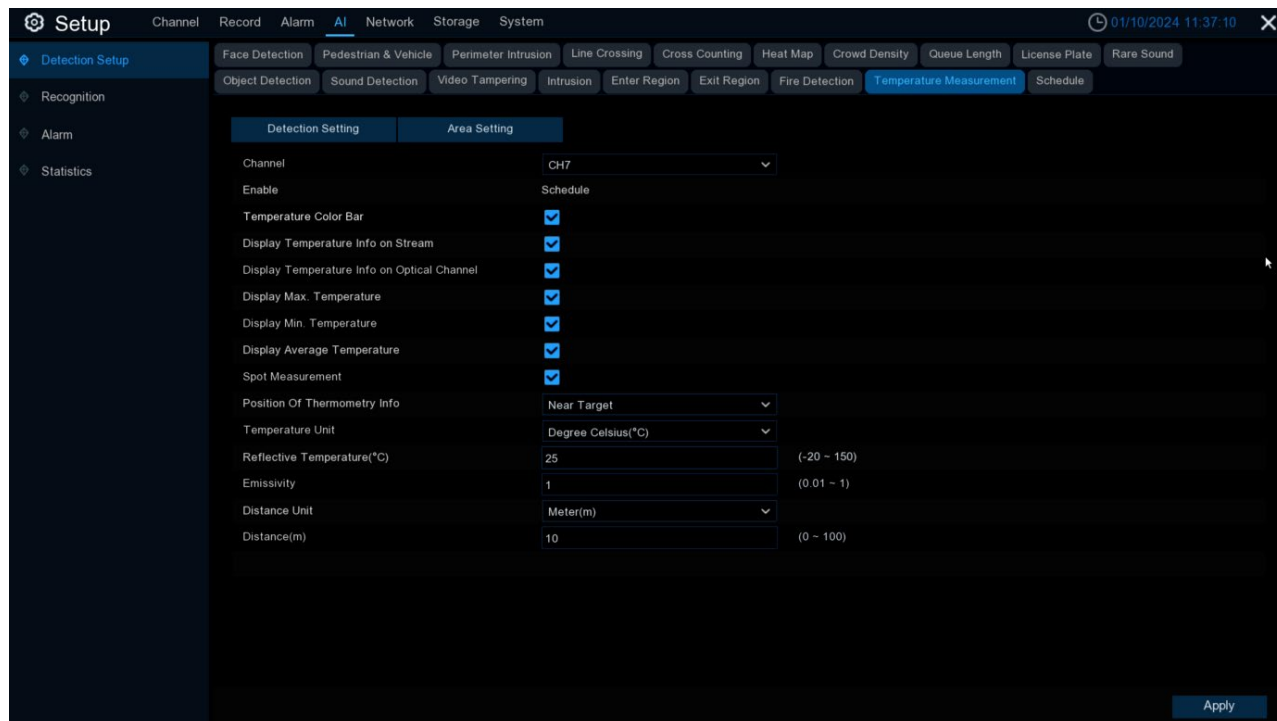

#### A. Temperature measurement detection setting

**Enable:** Enable or disable the temperature measurement function.

**Temperature Color Bar:** When turned on. On the right side of the thermal imaging channel preview screen, a color bar representing the different temperatures will be displayed. The max and min temperatures are also displayed.

**Display Temperature Info On Stream:** When turned on. Displays the temperature measurement area and the monitored temperature on the thermal channel preview screen.

**Display Temperature Info On Optical Channel:** When turned on, the temperature measurement area and the monitored temperature will be synchronized in the optical channel preview screen.

**Display Max. Temperature:** When turned on, the max monitored temperature is displayed on the preview screen. Need to turn on the switch for displaying temperature information first.

**Display Min. Temperature:** When turned on, the monitored temperature is displayed in the preview screen. Displays the min monitored temperature in the preview screen. Need to turn on the display temperature information switch first.

**Display Average Temperature:** When turned on. It will display the monitored average temperature in the preview screen, you need to turn on the switch of displaying temperature information first.

**Note:** A temperature measurement area ruled by a point will only display the average temperature of that point. The maximum and minimum temperatures will not be displayed.

**Spot Measurement:** when turned on. In the thermal imaging channel preview screen. Click on any area with the left mouse button to perform a single point measurement.

**Position of Thermometry Info:** You can set the position of the temperature information displayed in the preview screen.

**Near Target:** Temperature information is displayed next to the rules of each monitoring area.

**Top Left:** Temperature information is uniformly displayed in the top left corner of the preview screen.

**Temperature Unit:** Set the unit for displaying temperature information, including Celsius, Fahrenheit and Kelvin units.

**Reflective Temperature:** Set the ambient temperature of the camera.

**Note:** Reflected temperature is the ambient temperature reflected from the surface of the object being measured. When thermal radiation is reflected off the surface of an object, it is affected by the ambient temperature. The reflected temperature is the temperature of the reflected thermal radiation. The role of the reflected temperature is to help the thermal imaging camera to accurately measure the temperature of the surface of the object. In thermal radiation measurement. The infrared radiation received by the camera includes both radiation emitted from the object itself and reflected radiation from the environment. By measuring the ambient temperature, it is possible to distinguish between the thermal radiation emitted by the object and the thermal radiation reflected from the environment. Thus, the surface temperature of the object is accurately calculated.

**Emissivity:** Each target has a corresponding emissivity. The emissivity has a fixed value from rough to smooth. The emissivity is fixed from rough to smooth. Set the appropriate emissivity according to the type of temperature target to be measured. (Refer to the table of emissivity of common substances).

Substance	Emissivity
Human skin	0.98
Cotton fabric	0.98
Water	0.96
Asphalt	0.96
Concrete	0.95
Brick	0.95
Rubber	0.95
Paint	0.93
Ceramics	0.92
Soil	0.92
Printed circuit board	0.91
Paper	0.90
Cardboard	0.90
Sand	0.90
Wood	0.85

The table of emissivity of common substances

**Note:** Emissivity is the ability of the surface of the object being measured to emit infrared radiation. Its role is to affect the accuracy of the thermal imaging camera to measure the surface temperature of the object. Different emissivity, the object for infrared radiation reflection and absorption of different degrees, which will lead to the measurement results of the deviation.

**Distance Unit:** Includes both meter and inch options.

**Distance:** Indicates the straight line distance between the target to be measured and the device, which should be set according to the actual situation.

## B. Temperature measurement area setting

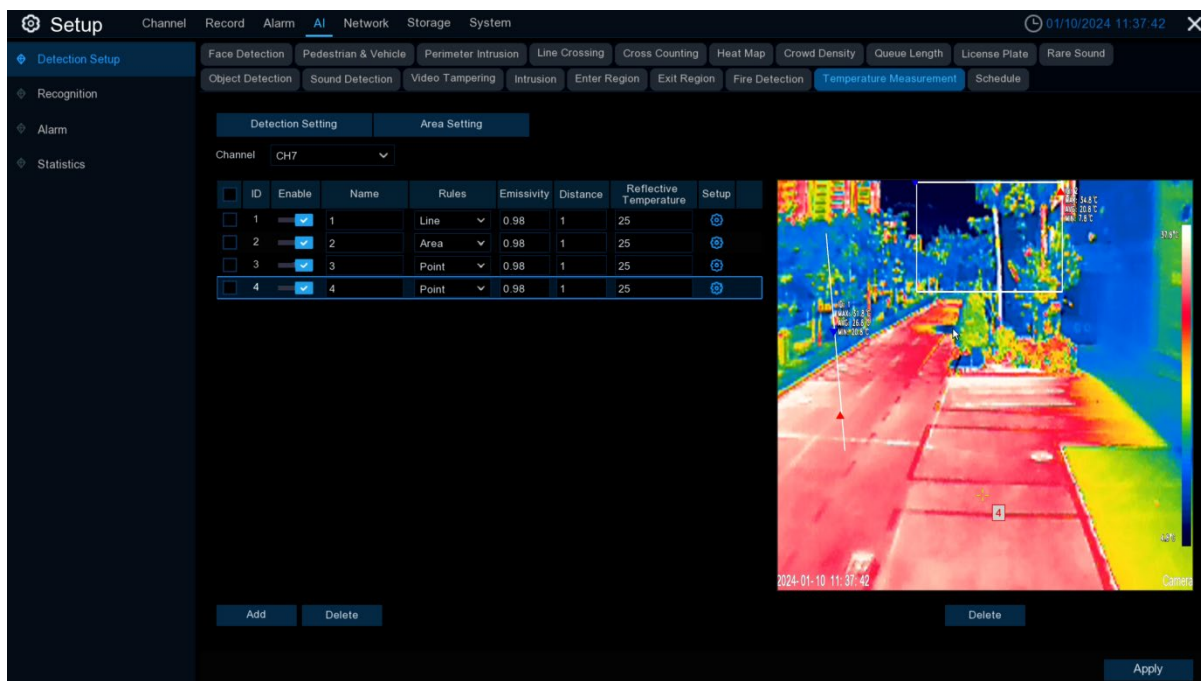

**ID:** Click Add to add a temperature rule. The maximum number of rules you can add is 20.

**Enable:** Select a temperature rule and enable it with "Enable".

**Name:** Customize the name of the rule.

**Rules:** Select temperature rules. Including points, lines and areas, Draw rules and determine the temperature measurement location in the right configuration screen, and click Delete to delete the drawn temperature measurement rules after checking the rules.

**Point:** Click anywhere on the right screen. This indicates that the selected point will be temperature measured. The preview screen will show the rule and average temperature information of the point.

**line:** Click anywhere on the right configuration screen. Hold down the mouse and drag to another location to draw a temperature rule line. This indicates that the temperature will be measured at the location on the line. Click on the checkbox of the rule line to adjust the length, angle and position of the rule line. The preview screen will show the rule and temperature information of the temperature measurement line segment.

**Area:** Click anywhere in the configuration screen on the right. Hold down the mouse and drag to another location to draw a quadrilateral temperature rule area. Indicates that the location of the area is to be temperature measured. Click the checkbox of the rule area to adjust the size and position of the rule area. The preview screen displays the rule and temperature information for this temperature measurement region.

**Emissivity:** Set the appropriate emissivity according to the type of target to be measured.

**Distance:** Set the distance between the target and the device.

**Reflective Temperature:** Set the ambient temperature of the camera.

**Setup:** Click  to enter the Alarm Rule Setup page and set the alarm rule for each temperature measurement rule.

Check the temperature rule and click "Delete" to delete it.

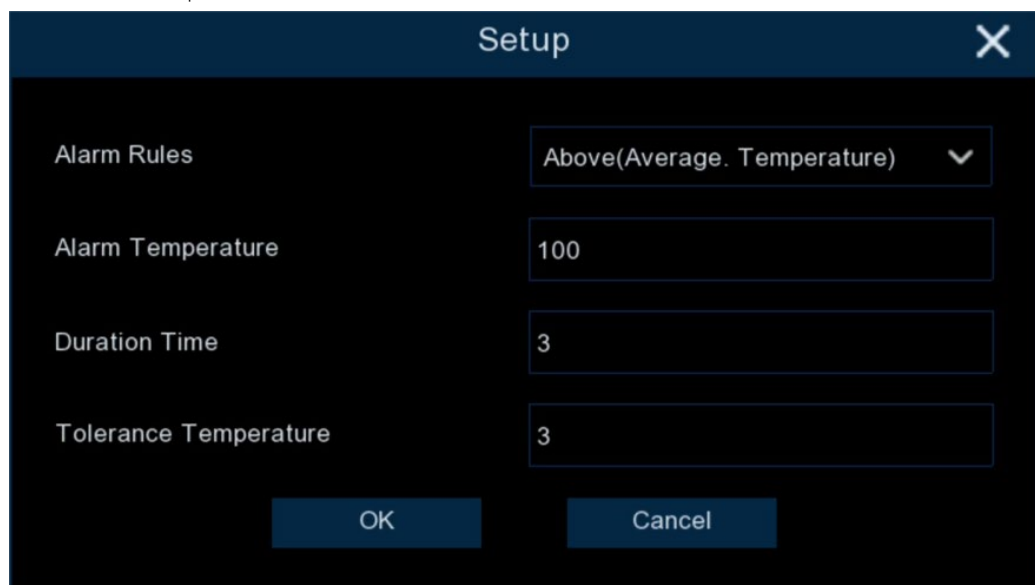

**Alarm Rules:** There are several alarm rules, Above(Max.Temperature), Below(Max.Temperature), Above(Min.Temperature), Below(Min.Temperature), Above(Average.Temperature), Below(Average.Temperature), Above(Temperature Difference), Below(Temperature Difference). The only alarm rules for the Point temperature rule are Above(Average.Temperature), Below(Average.Temperature).

**Alarm Temperature:** Set the temperature threshold for alarm.

**Duration Time:** Indicates the time when the temperature of the measured object continuously exceeds the temperature threshold. If it exceeds this time, the alarm will be triggered.

**Tolerance Temperature:** prevent the temperature from oscillating back and forth to affect the alarm effect.

For example, the alarm rule selects an average temperature greater than. The alarm temperature is set to 40°C. The duration is set to 3 s. The tolerance temperature is set to 3°C. The duration is set to 3s. the tolerance temperature is set to 3°C. When the average temperature of the area monitored by this temperature measurement rule is greater than 40°C and the duration exceeds 3s, the alarm is triggered. The alarm is canceled only when the average temperature of the monitored area is less than or equal to 37°C.

### 5.4.1.19 Schedule

When the IPC is connected to the DVR with a media port, the schedule is as follows:

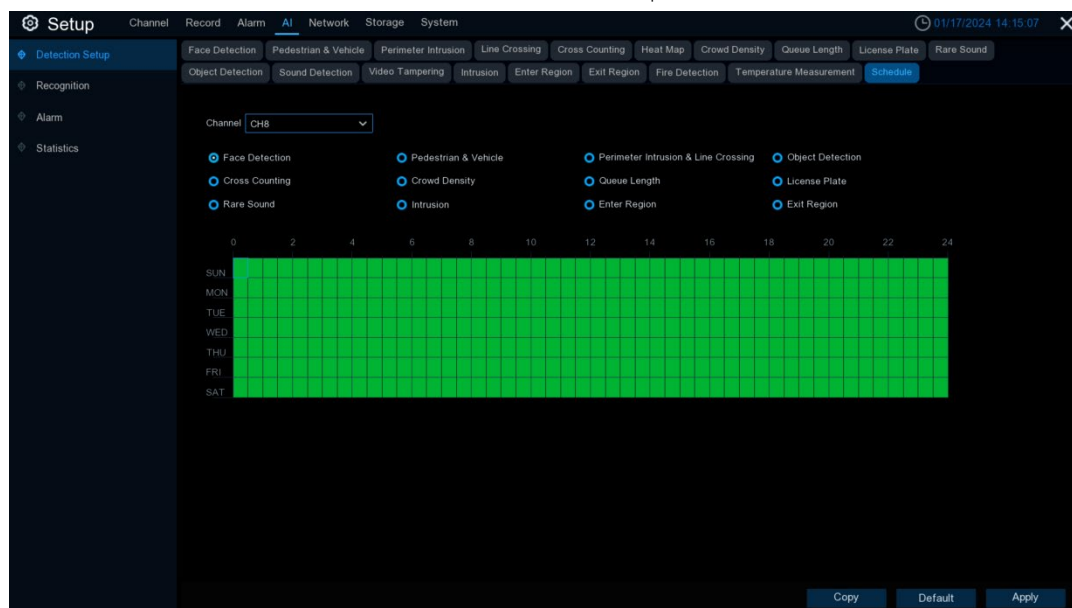

Set the schedule for triggering alarms for each AI function. Checked is on, unchecked is off.

When the IPC connects to the DVR using the HTTP port, the schedule is as follows:

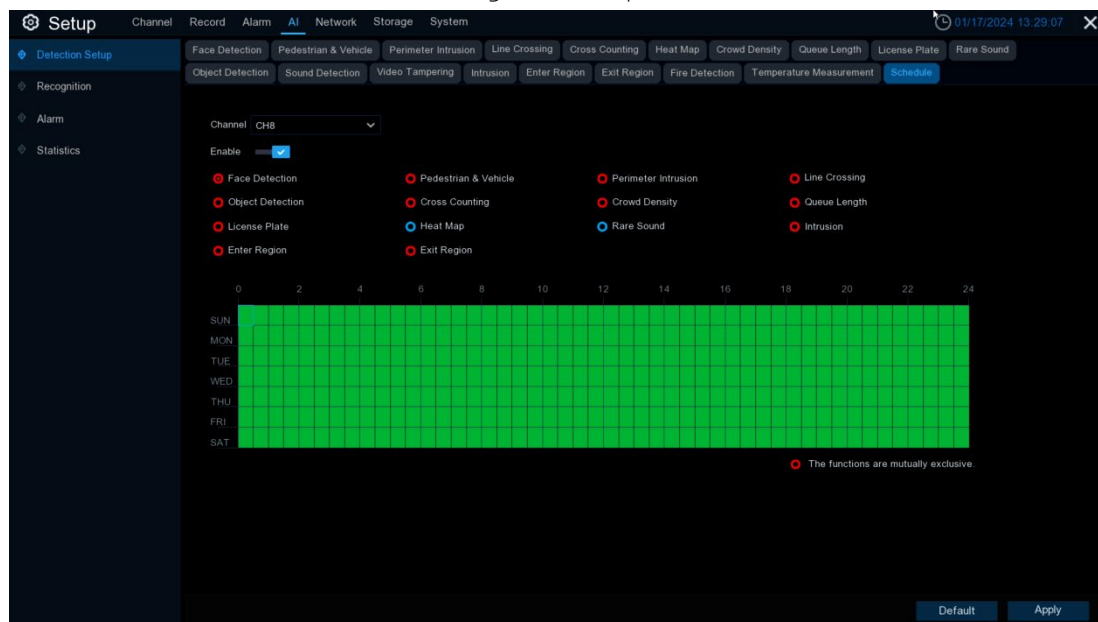

Set the schedule for triggering alarms for each AI function to be turned on. Checked is on, unchecked is off, and grayed out is not settable.

**Enable:** When enabled, all AI functions of the channel will be controlled by the schedule, and the function switch displays Schedule

**Functions are mutually exclusive:** Functions that are mutually exclusive with the selected function.



## 5.4.2 Recognition

### 5.4.2.1 Model Configuration

Select the algorithm model in this menu. There are local and IPC algorithm models (some devices do not have local algorithm models and need to take the IPC of the algorithm model).

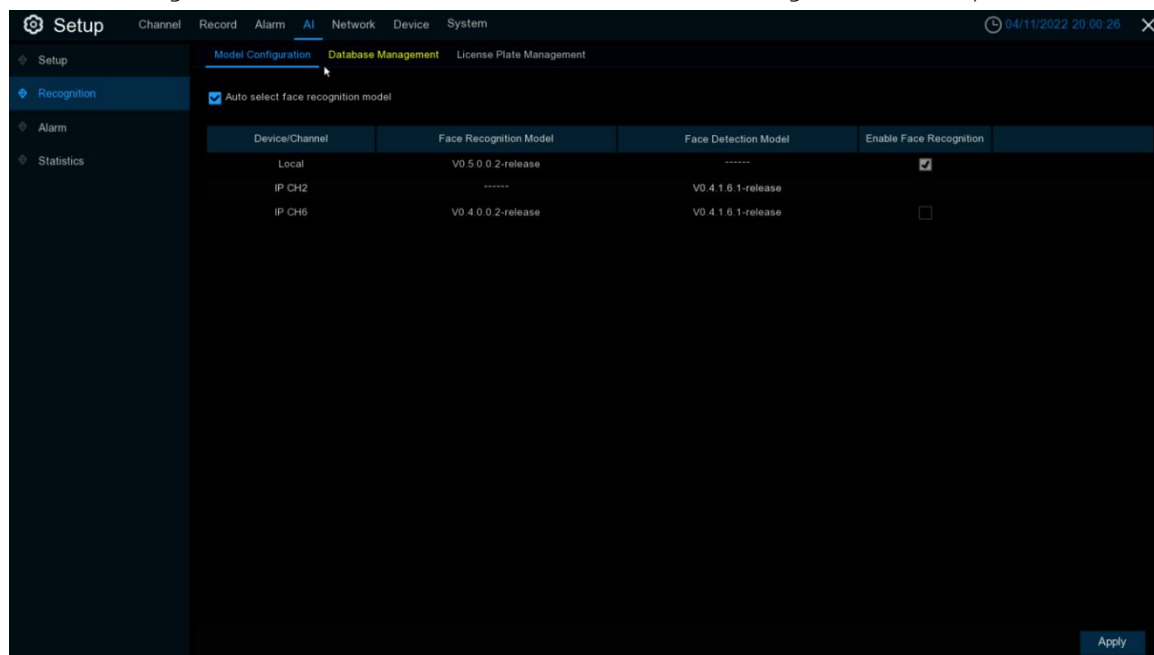

### 5.4.2.2 Database Management

This menu sets up a database for face recognition database.

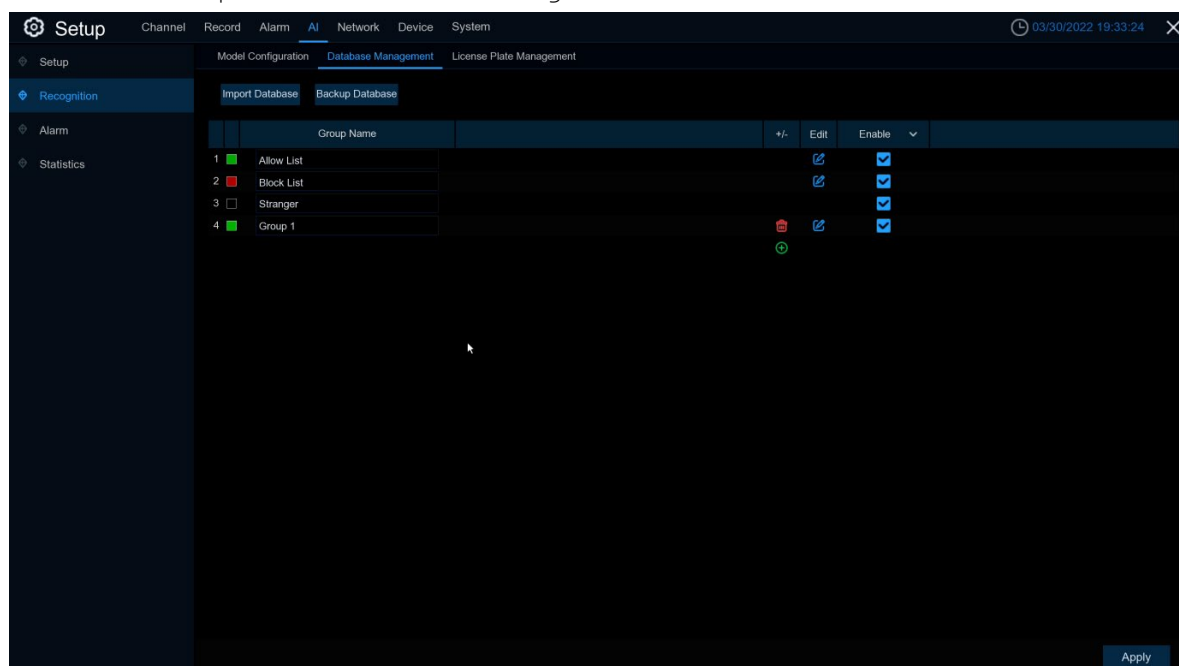

**Import Database:** Import the exported file to the device.

**Backup Database:** Export all of the groups into the U disk.

**Update facial features:** Update face features, switching the face features model or imported from external files face images or face database, after AI IPC recognition detected the face database face features and the current check face features model is inconsistent, will pop up update face features, click update face features will be shown in the following figure below

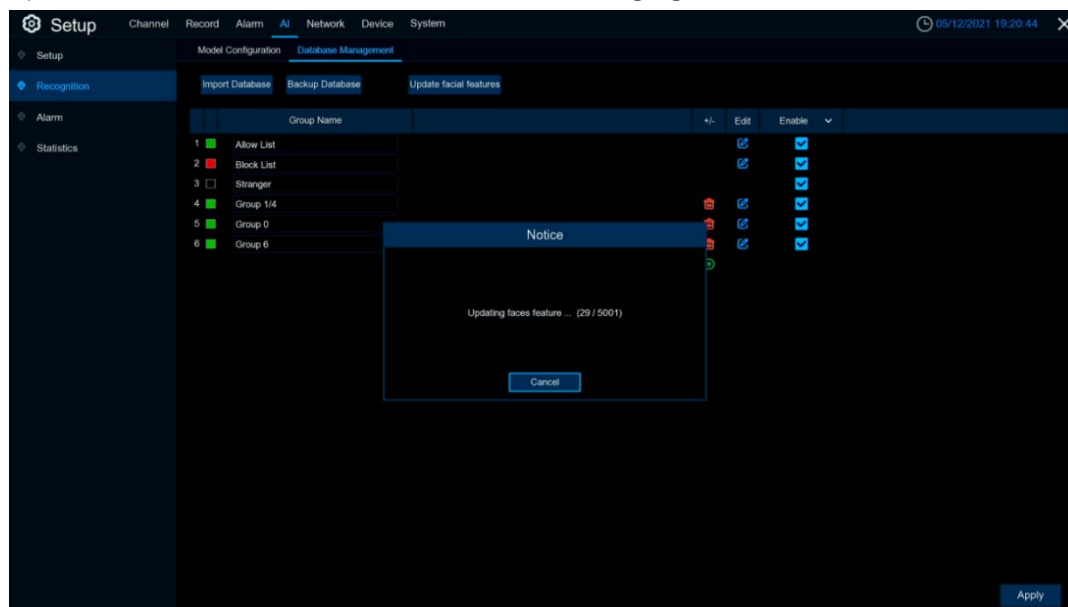

Click **Cancel** will pop up a prompt to continue or suspend the update, the remaining not updated next Click to update.

Click / : add a new face group or delete an existing face group.(The default first three face groups cannot be deleted)

**Enable:** Enable or disable face recognition group.

**Edit:** Click **Edit** to enter the editing face group interface.

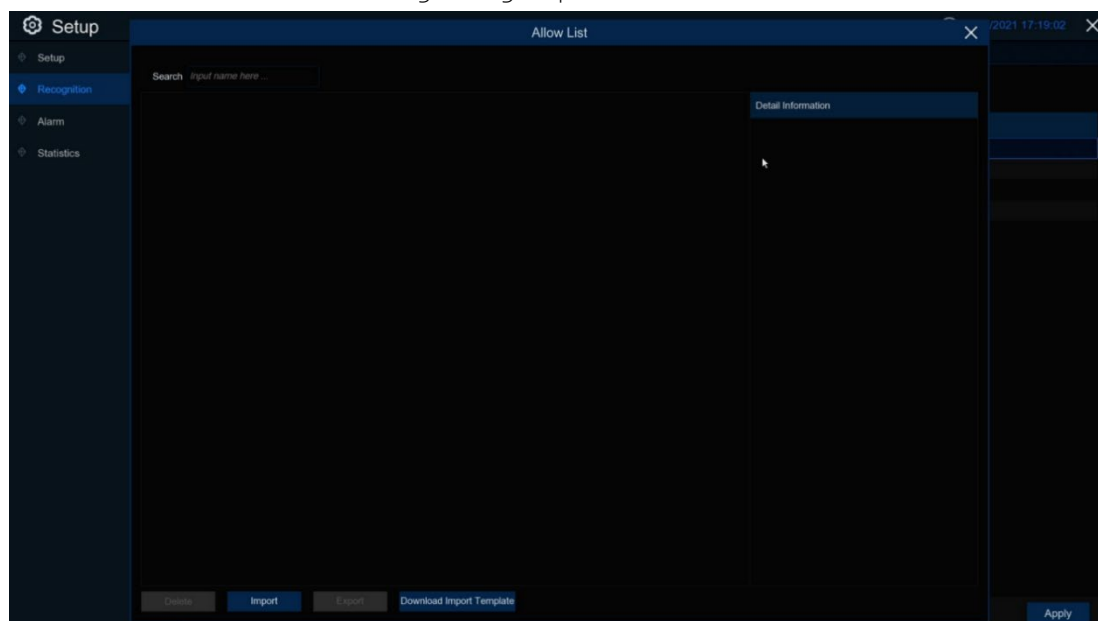

**Import:** Click [Local Storage Device](#) to enter local face interface.

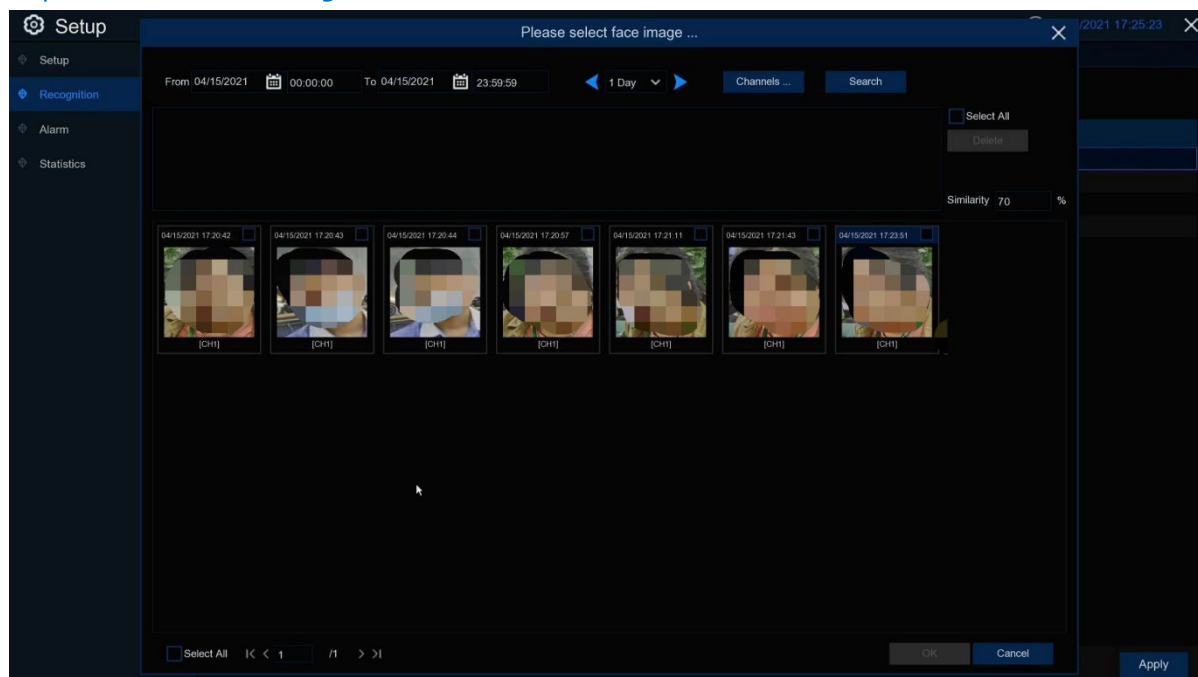

Select date, duration and channels, click [Search](#) to search all of faces saved to the devices during that time. If you select face similarity and then click [Search](#), it will be searched out face which match to similarity. Click faces result image and [Delete](#), select face and click [OK](#) to enter import face page.

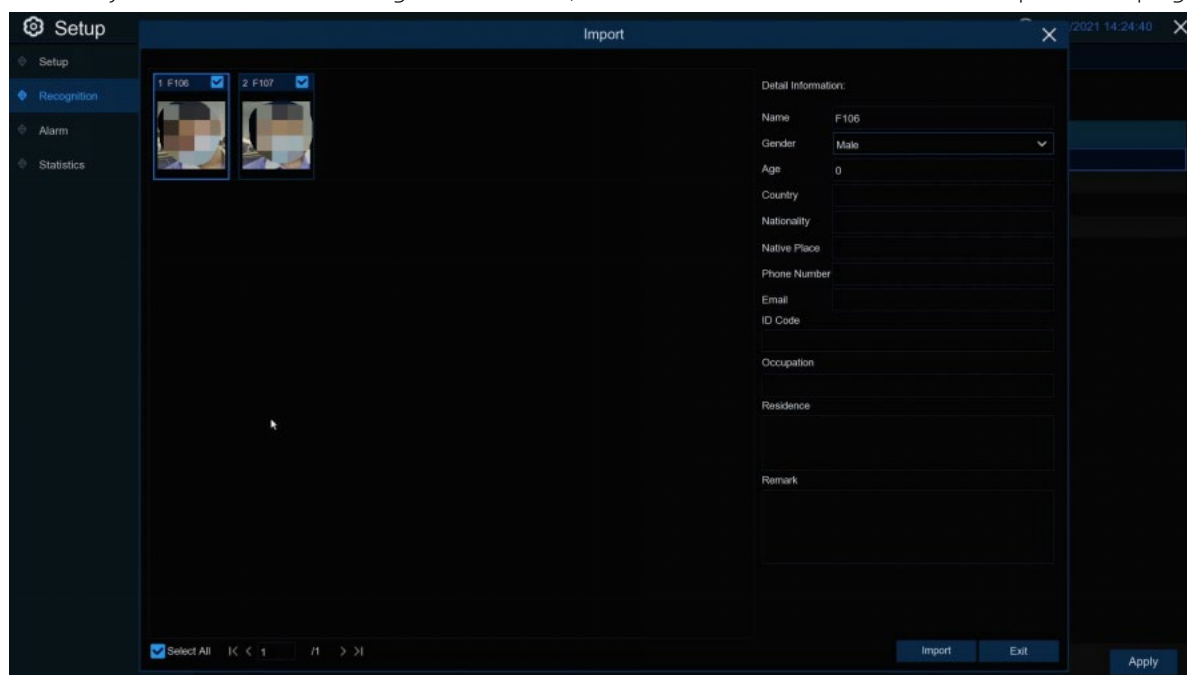

Edit face information in the right box, after editing, click [Import](#) to finish, click [Exit](#) to exit the interface.

Click [External Storage Device](#), enter external memory storage, select the face image you want to import, the same step as importing the local face.

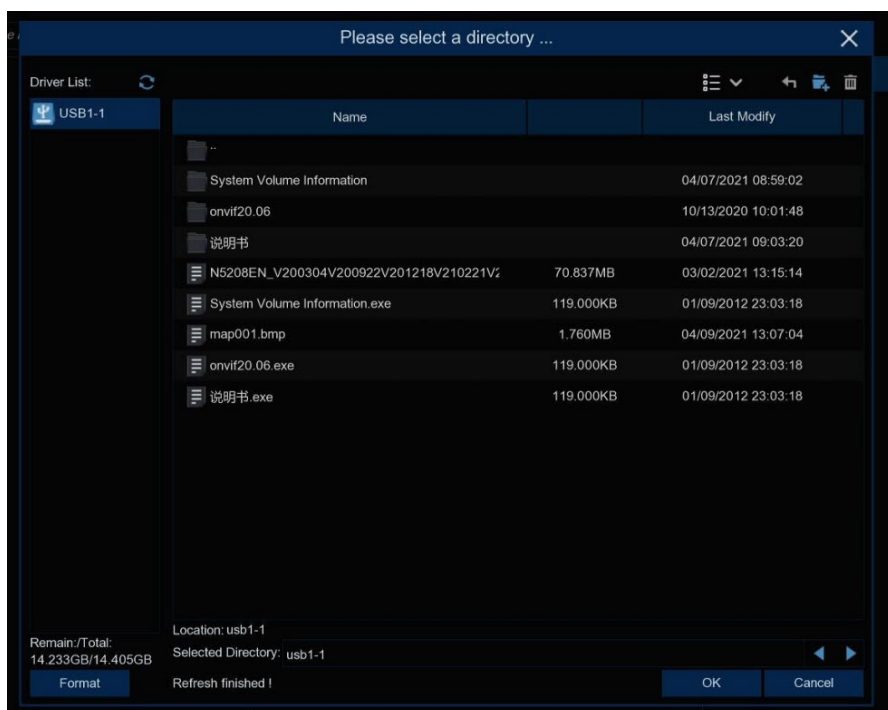

**Export:** Export the face picture to the external memory storage, if you do not Click to the face group picture to **Export** all the face pictures of the face group.if you Click to the face group face picture to Click **Export** to export the selected face picture.

**Download import Template:** Download and import the template, you can export a template to an external memory, this template can contain a form and use instructions, you can fill in the information of the face picture information in this form, import this form can modify the information of multiple name face pictures, convenient to modify the face picture information.

Right-Click to select the face picture, select **Edit** to enter the face picture editing interface, and click **Additional Face image** to import the face picture under different circumstances of the face.

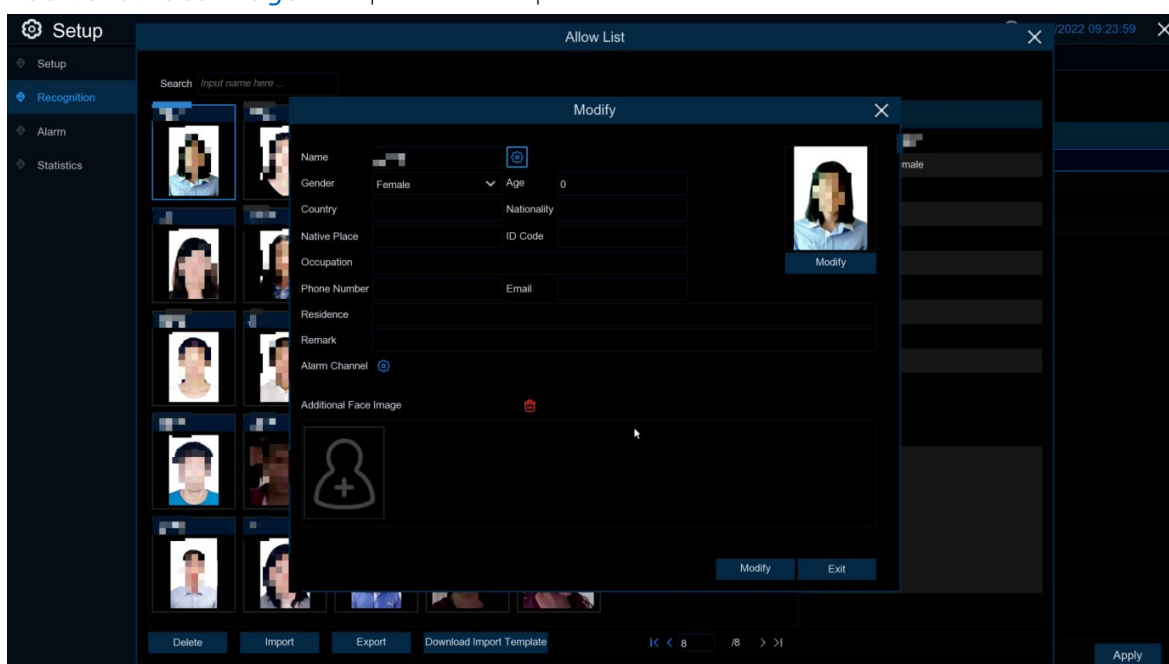

### 5.4.2.3 License Plate Management

This menu provides a license plate information database for comparing the detected license plate information.

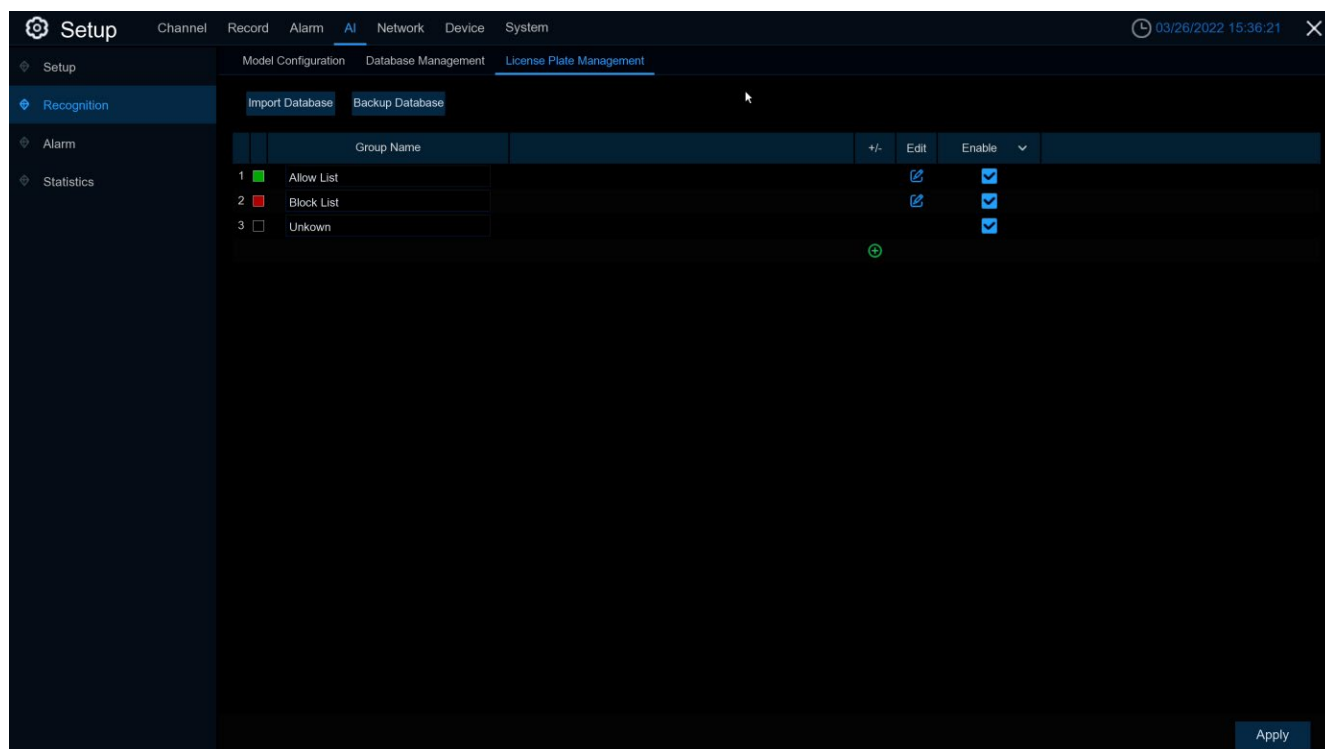

**Import Database:** Import the exported packet data into the device.

**Backup Database:** Export all the groups to a U disk.

**Group Name:** The name of the database group, ■ allow list, ■ black list, ■ stranger group, you can add up to 61 custom groups, a total of 64 groups, one group can accommodate up to 5000 license plate information, the whole database can accommodate 10000 license plate information.

Click / : To add a new license plate group or delete an existing license plate group. (The default first three license plate groups can not be deleted)

**Edit:** Click Edit to enter the edit license plate group interface.

**Enable:** Enable or disable license plate detection.

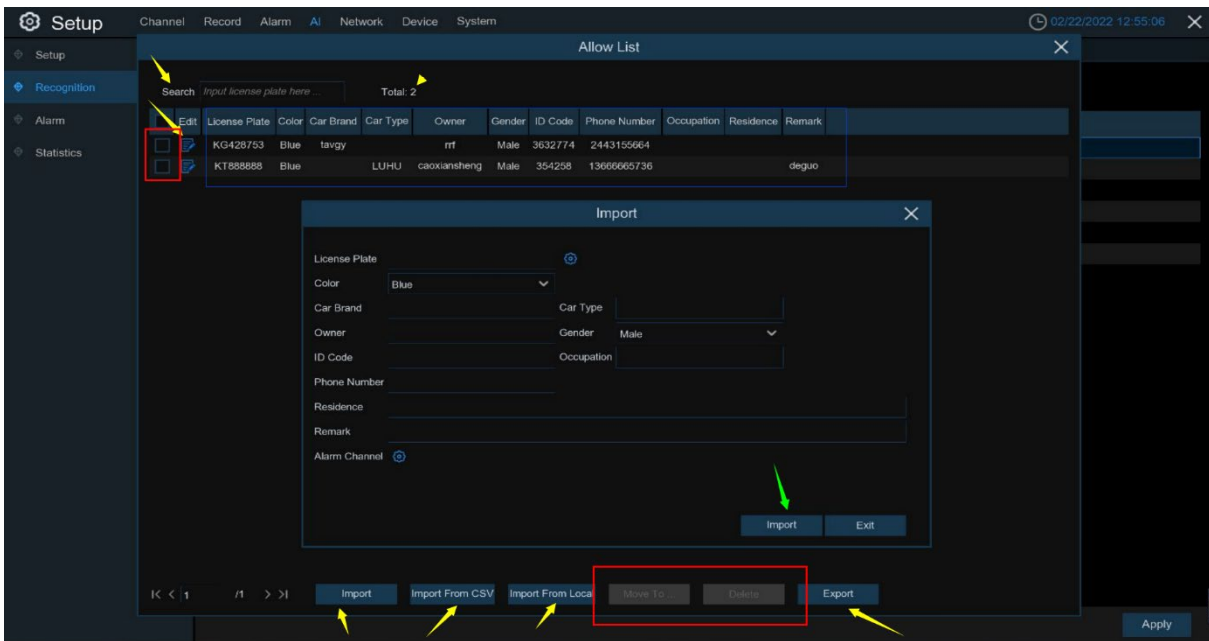

**Search:** filtering license according to keywords.

**Total:** Total number of license plate data in this group.

Click  to modify the corresponding license plate data information. There are three ways to add license plate information: Import (manually added), Import From CSV (CVS table import), and Import From Local (local import).

Click **Import** button to manually add a single license plate information,

Click **Export** to export the entire group information to the external U disk.

**Alarm Channel:** Set the channel to alarm after the license plate is detected and successfully aligned.

**Move to...:** Check the re-check box of the license plate information and click it again to transfer the license plate information to another group.

**Delete:** Check the re-check box of the license plate information and then click this button to delete the license plate information.

Click **Import From CSV** button to import one or more CVS pieces of data. The format of the CVS table is shown below:

A	B	C	D	E	F	G	H	I	J	K	L	M	N	O	P	Q	R	S	T	U	V	W	X	Y	Z	
1	License Plate	Color	Car Brand	Car Type	Owner	Sex	Id Code	Phone	Occupati	Residence	Remark															
2	HC-29255	blue	RUBH	Volkswagen	HEI	male	2222	2212211	22222	46491	FOFQWQ															
3	A-BP-233	white	RUB	NORMAL	OTGU	male	101	11111	LLLLL	KLEKLE	FOFQWQ															
4	WC114J	black	EBBE	BUSMAL	Q00Q	female	102	2145435	DAPRQR	FFGF	QTFY															
5	P18-500	black	K3S2AD	KDSE	Q0QD	female	103	453255	SPFES	QAGA	QTFY															
6	MA 5465	white	TRWAGA	SPSPF	P9FFFP	female	104	532535	FVFVA	PAGA	FVFVA															
7	Q2 9671	white	K0FTT229	BEPTFC	W1AZHT	female	105	2.39249	RFAGEC	AGAG	AGET															
8	L866	ERE	white	G4SJJHEFJ	TASDSE	ATYDFZDT	male	106	S.4TE+08	Ftqtz	agzhzh	agrzagagza														
9	R21	ROY	white	BEH	T4T34	ANRTAT	male	107	SJJYBRC	HRJFFJED	STUDROFRSTOHE															
10	DE14	LTP	white	STUJHEB	4760RQ	AERFYDF	female	108	46034	W6GABA	AF325	RIXTT														
11	1218	LGJ	white	ESRSTRST	YEVOD	CSYBQDX	male	109	467373975	SCEG	SDCSHERTRTKTDFX															
12	W12	FRA	yellow	GREPAGG	AGEAGE	G48TCVZ	female	110	4549393	FQSEA	GSC	FOAA														
13	W13	FRA	blue	RUBH	BEPTFC	CSYBQDX	male	112	2212225	22222	46473	FOFQWQ														
14	W14	FRA	blue	RUBH	BEPTFC	CSYBQDX	male	113	2212224	22222	46474	FOFQWQ														
15	W15	FRA	blue	RUBH	BEPTFC	CSYBQDX	male	114	2212225	22222	46475	QTFY														
16	W16	FRA	blue	RUBH	BEPTFC	CSYBQDX	male	115	2212226	22222	46476	QTFY														
17	W17	FRA	blue	RUBH	BEPTFC	CSYBQDX	male	116	2212227	22222	46477	FVFVA														
18	W18	FRA	blue	RUBH	BEPTFC	CSYBQDX	male	117	2212228	22222	46478	AGET														
19	W19	FRA	blue	RUBH	BEPTFC	CSYBQDX	male	118	2212229	22222	46479	agrzagagza														
20	W20	FRA	blue	RUBH	BEPTFC	CSYBQDX	male	119	2212230	22222	46480	ETORH														
21	W21	FRA	blue	RUBH	BEPTFC	CSYBQDX	male	120	2212231	22222	46481	RIKTT														
22	W22	FRA	blue	RUBH	BEPTFC	CSYBQDX	male	121	2212232	22222	46482	TRTKTDFX														
23	W23	FRA	blue	RUBH	BEPTFC	CSYBQDX	male	122	2212233	22222	46483	FOAA														
24	W24	FRA	blue	RUBH	BEPTFC	CSYBQDX	male	123	2212234	22222	46484	FOFQWQ														
25	W25	FRA	blue	RUBH	BEPTFC	CSYBQDX	male	124	2212235	22222	46485	FOFQWQ														
26	W26	FRA	blue	RUBH	BEPTFC	CSYBQDX	male	125	2212236	22222	46486	QTFY														
27	W27	FRA	blue	RUBH	BEPTFC	CSYBQDX	male	126	2212237	22222	46487	QTFY														
28	W28	FRA	blue	RUBH	BEPTFC	CSYBQDX	male	127	2212238	22222	46488	FVFVA														
29	W29	FRA	blue	RUBH	BEPTFC	CSYBQDX	male	128	2212239	22222	46489	AGET														
30	W30	FRA	blue	RUBH	BEPTFC	CSYBQDX	male	129	2212240	22222	46490	agrzagagza														
31	W31	FRA	blue	RUBH	BEPTFC	CSYBQDX	male	130	2212241	22222	46491	ETORH														
32	W32	FRA	blue	RUBH	BEPTFC	CSYBQDX	male	131	2212242	22222	46492	RIKTT														
33	W33	FRA	blue	RUBH	BEPTFC	CSYBQDX	male	132	2212243	22222	46493	TRTKTDFX														
34	W34	FRA	blue	RUBH	BEPTFC	CSYBQDX	male	133	2212244	22222	46494	FOAA														
35	W35	FRA	blue	RUBH	BEPTFC	CSYBQDX	male	134	2212245	22222	46495	FOFQWQ														
36	W36	FRA	blue	RUBH	BEPTFC	CSYBQDX	male	135	2212246	22222	46496	FOFQWQ														
37	W37	FRA	blue	RUBH	BEPTFC	CSYBQDX	male	136	2212247	22222	46497	QTFY														
38	W38	FRA	blue	RUBH	BEPTFC	CSYBQDX	male	137	2212248	22222	46498	QTFY														
39	W39	FRA	blue	RUBH	BEPTFC	CSYBQDX	male	138	2212249	22222	46499	FVFVA														
40	W40	FRA	blue	RUBH	BEPTFC	CSYBQDX	male	139	2212250	22222	46500	AGET														
41	W41	FRA	blue	RUBH	BEPTFC	CSYBQDX	male	140	2212251	22222	46501	agrzagagza														

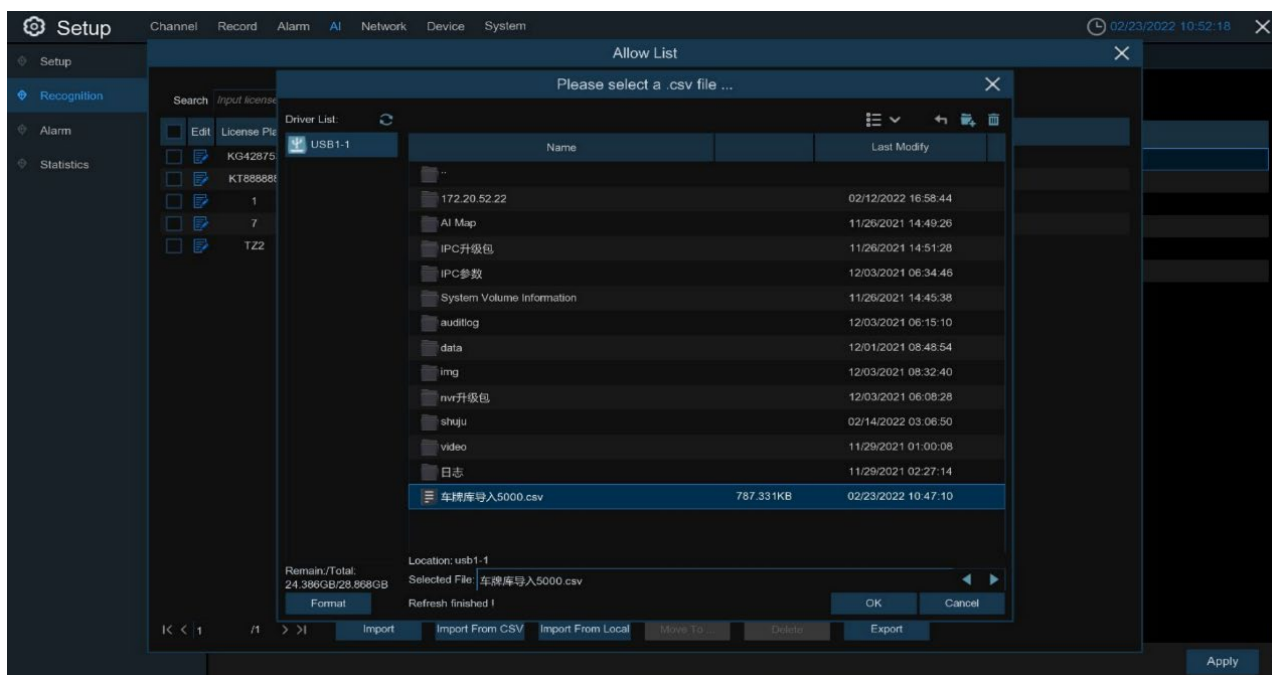

Click **Import From CSV** button to pop up the above interface, select the CSV license plate file to be imported, and click the OK button. Pop up the following below:

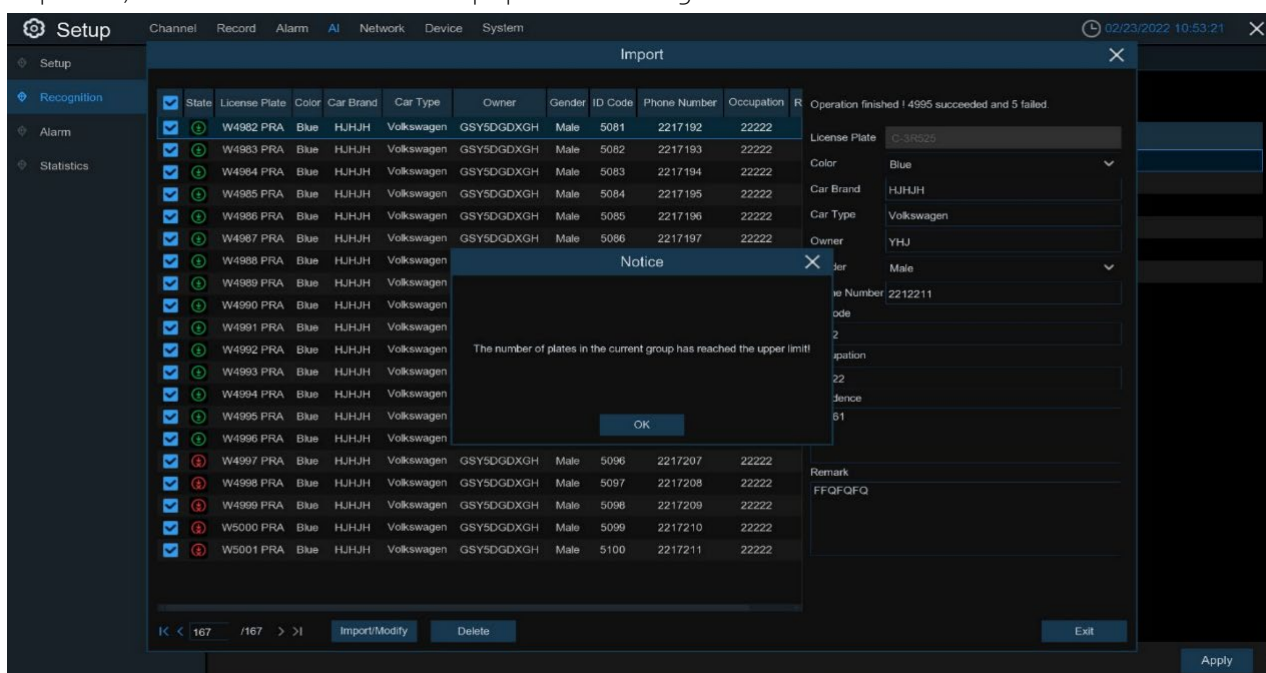

Click **Import/Modify** button to add a batch, and you can also modify one license plate information. When more than 5000 data are added, the message box with the content of "Add data has reached the upper limit of the group" will popup.

Click **Import From Local** button to import the license plate information locally to the database.

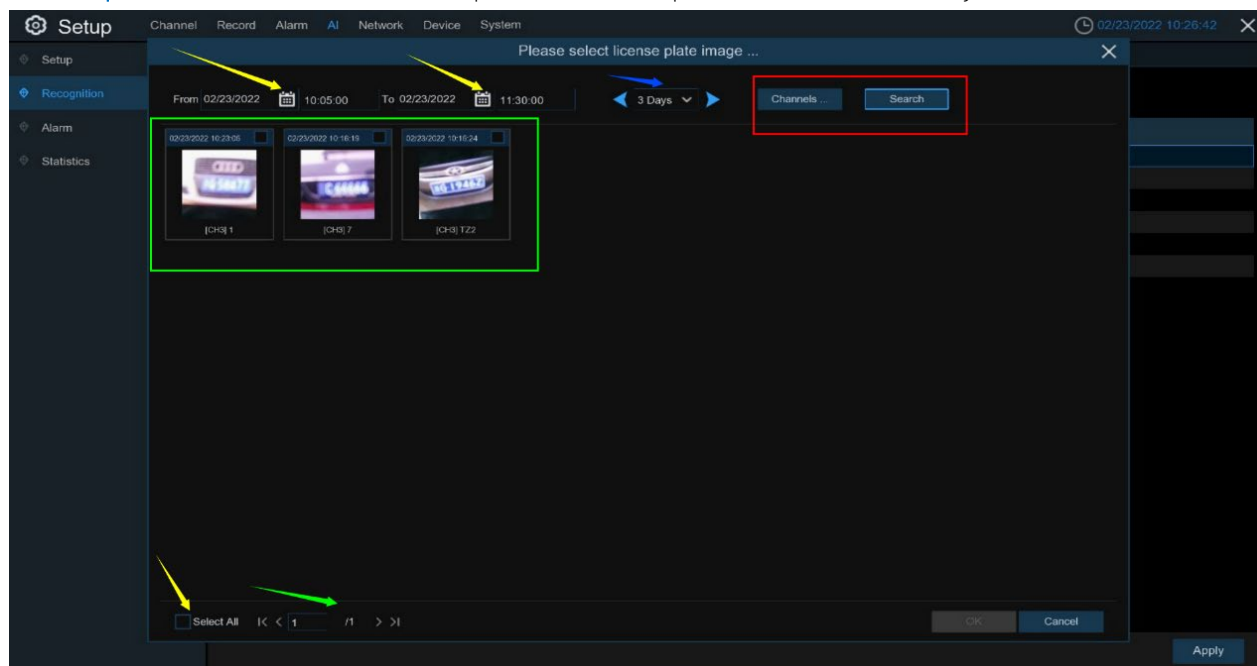

Select date, duration and channels then click **Search** to search license plates saved by all devices during this time.

**Channels:** License plate detection events triggered by each channel.

**Select All:** Select all the license plate information.

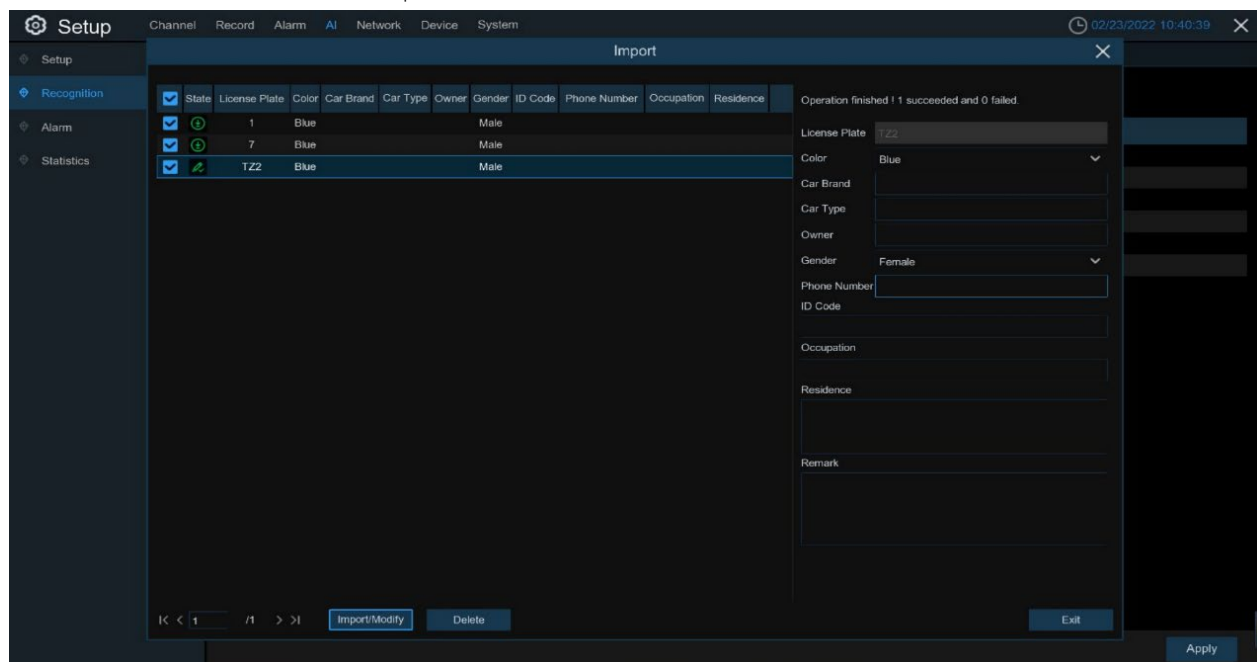

Click one of data to edit the license plate information and click **Import/Modify** button to modify, if the modification is successful. 🟢 will become 🟡.



## 5.4.3 AI Alarm

### 5.4.3.1 Face Detection Alarm Settings

To configure alarm actions for different groups when faces detected.

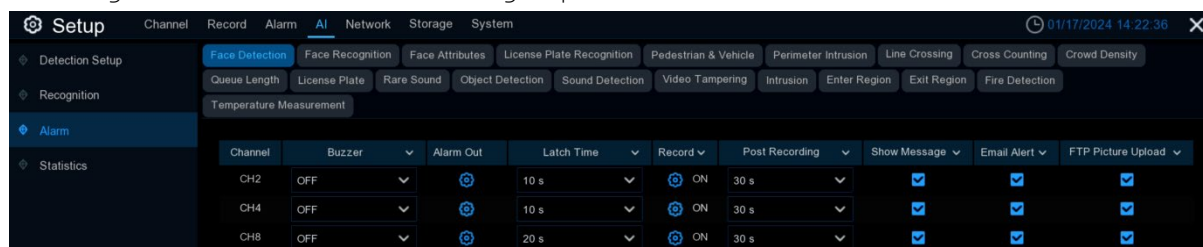

**Channel:** Select an available to configure.

**Buzzer:** The DVR can sound an alarm tone using its internal buzzer. Set the duration (in seconds) of the buzzer when the alarm is triggered.

**Alarm out:** optional function. the DVR supports connecting to an external alarm device, then you can set the external alarm device.

**Latch Time:** Set the external alarm time when an alarm is detected

**Record:** Click on the AA icon to select the channel to be recorded when the alarm is triggered.



**Post Recording:** Set the length of time the DVR will continue to record after an event. The recommended recording time is 30 seconds, but can be set to a maximum of 5 minutes.

**Show Message:** Check this box to display the  icon on the live display screen when an alarm is detected.

**Email Alert:** When an alarm is detected, a capture image will be sent to the set email address.

**FTP Picture Upload:** When an alarm is detected. The picture will be sent to the set FTP server.

**FTP Video Upload:** When the alarm is detected. It will send the video to the set FTP server.

**Picture to Cloud:** When an alarm is detected. It will send the captured picture to the set cloud storage server.

**Video to Cloud:** When an alarm is detected. Video to Cloud: When an alarm is detected, video will be sent to the set cloud storage server.

**Full Screen:** If this feature is enabled and an alarm is detected in a channel, the channel will be previewed in full screen mode.

**Event Push Platform:** When an alarm is detected. An alarm message will be sent to the third party platform that the device is connected to.

**Voice Prompts:** The audio file into which the voice prompt is imported when this alarm is triggered (requires IPC support for voice prompts).

### 5.4.3.2 Face Recognition Alarm Settings

Alarm settings made by the DVR when a face within a grouping is detected.

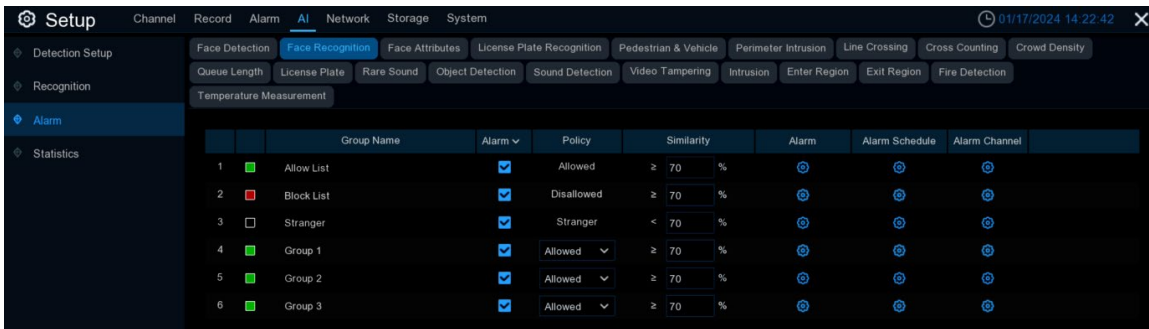

**Enable alarm:** Enable or disable the face detection alarm.

**Policy:** Setting the alarm policy for face grouping

**Similarity:** Similarity setting

**Alarm:** Click to enter the setting interface.

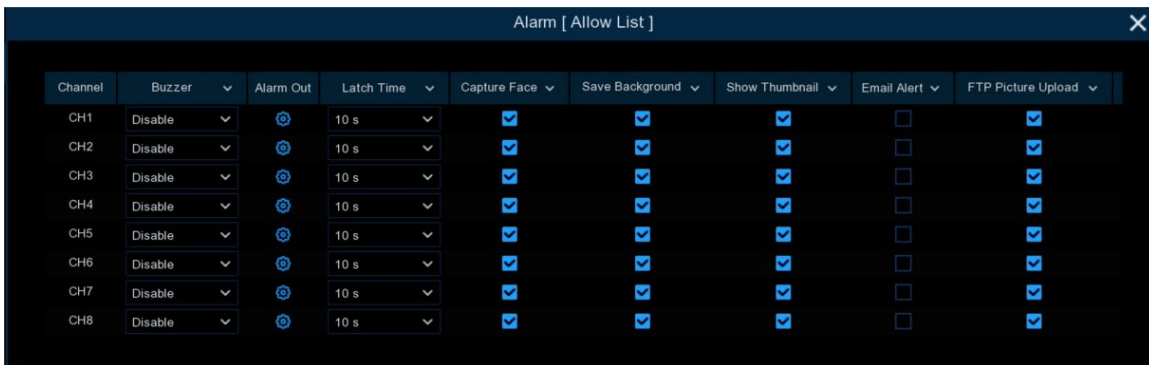

**Buzzer:** The DVR can use its internal buzzer to sound an alarm tone. Set the duration (in seconds) of the buzzer when the alarm is triggered.

**Alarm Out:** Optional feature that allows the DVR to be connected to an external alarm device if the DVR supports the connection of an external alarm device.

**Latch Time:** Set the external alarm time when an alarm is detected.

**Capture Face:** When a face is detected, the capture image of the face will be saved.

**Save Background:** When a face is detected, the whole preview image will be saved.

**Show Thumbnail:** When a face is detected, the preview will have a thumbnail popup alert.

**Email Alert:** When an alarm is detected, it will send the captured image to the set email address.

**FTP Picture Upload:** When the alarm is detected, the picture will be sent to the set FTP server.

**Picture to Cloud:** When an alarm is detected, a picture will be sent to the set cloud storage server.

**Event Push Platform:** When an alarm is detected, it will send an alarm message to the third-party platform that the device is connected to.

**Voice Prompts:** The audio file into which the voice prompt is imported when this alarm is triggered (requires IPC support for voice prompts).

**Alarm Schedule:** Click to enter the Setup Schedule screen.

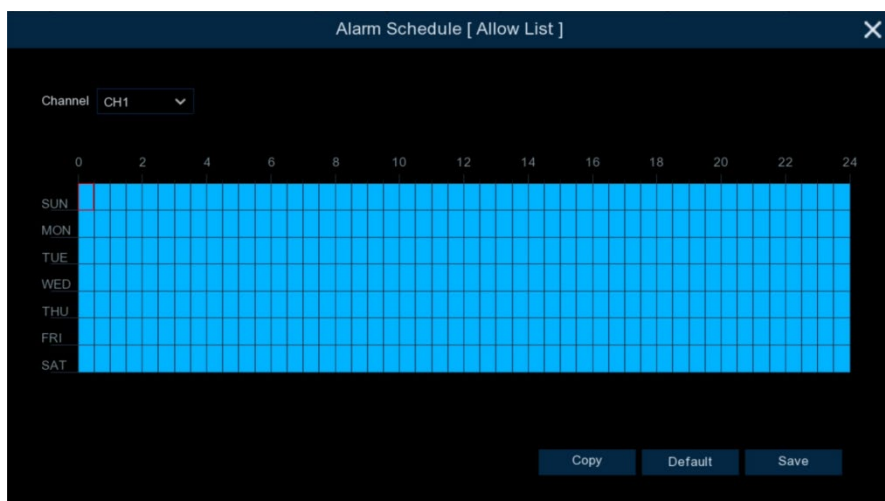

Check the time period you want to alarm **Exit** and click Apply. Copy can be copied to other channels.

**Alarm Channel:** Set the channel for Trigger when the face is detected and compared successfully.

### 5.4.3.3 Face Attribute Alarm Settings

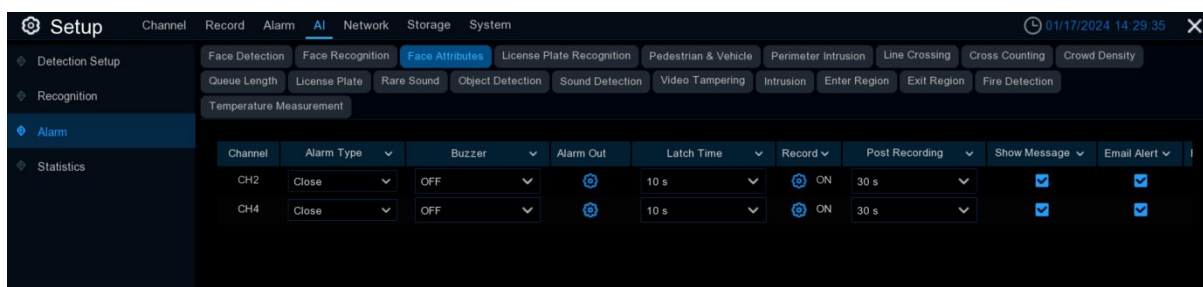

**Channel:** Channel name

**Alarm type:** Set the alarm type of face attribute, support Close, No Mask and Wear Mask.

**Buzzer:** The DVR can use its internal buzzer to sound an alarm. Set the duration (in seconds) of the buzzer when the alarm is triggered.

**Alarm out:** Optional feature that allows the DVR to be connected to an external alarm device if the DVR supports the connection of an external alarm device.

**Latch Time:** Set the external alarm time when an alarm is detected.

**Record:** Click the icon to select the channel to be recorded when the alarm is triggered.



**Post Recording:** Set the length of time the DVR will continue to record after an event. The recommended recording time is 30 s, max 5 minutes.

**Show Message:** Check this box to display the icon on the live display screen when an alarm is detected.

**Email Alert:** When an alarm is detected, a capture image will be sent to the set email address.

**Full Screen:** If this feature is enabled and an alarm is detected on a channel, the channel will be previewed in full screen mode.

**Event Push Platform:** When an alarm is detected, an alert message will be sent to the third party platform that the device is connected to.

**Voice Prompts:** The audio file into which the voice prompt is imported when this alarm is triggered (requires IPC support for voice prompts).

### 5.4.3.4 License Plate Recognition Alarm Settings

The alarm setting that the DVR makes when it detects a license plate in a group.

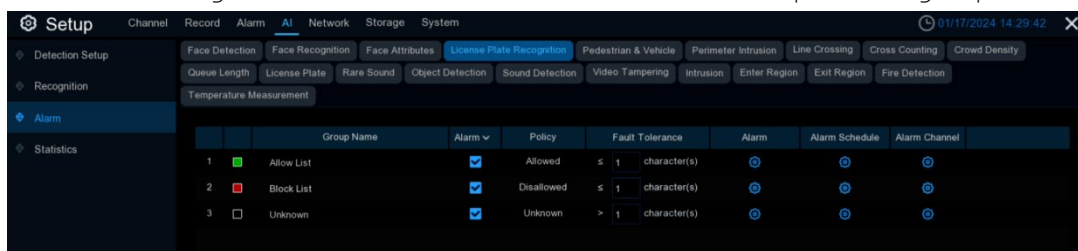

**Group Name:** Group name.

**Enable alarm:** Enable or disable the license plate detection alarm.

**Policy:** Set the alarm policy for license plate grouping.

**Fault-tolerant:** For example, if you set three characters, the white list license plate number in the group is B594SB, when a license plate number B734KB enters into the monitoring area, the alarm will be triggered. That is to say, if there are 0~5 characters in the detected license plate number which are different from the license plate number in the database, the alarm will be triggered.

**Alarm Channel:** Set the channel to Trigger when the license plate is detected and compared successfully.

**Alarm:** Click  to enter the setting interface.

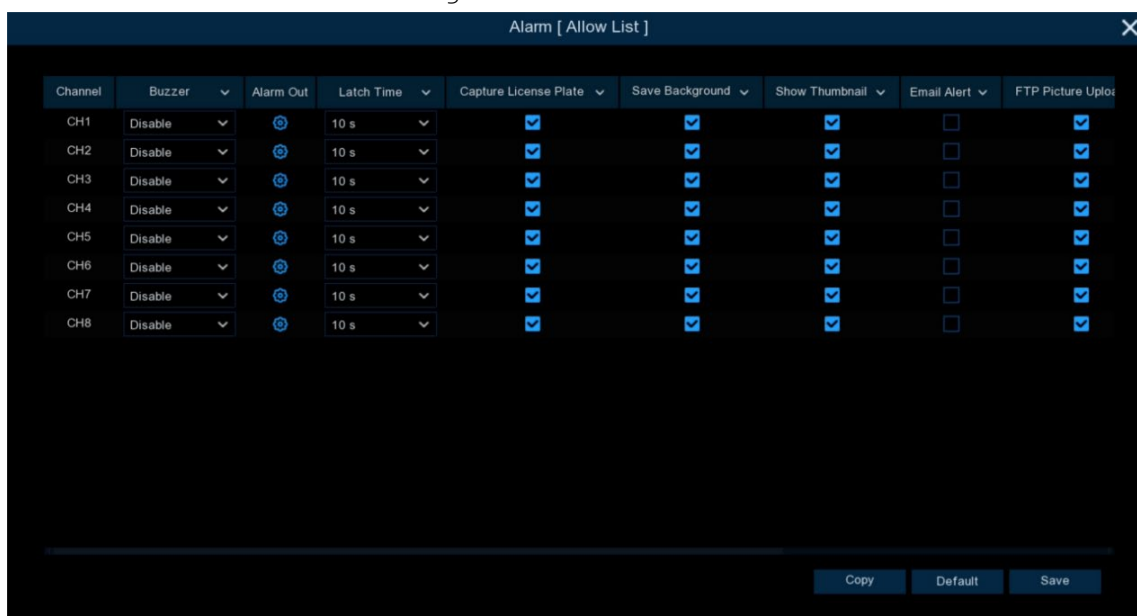

**Buzzer:** The DVR can use its internal buzzer to sound an alarm tone. Set the duration (in seconds) of the buzzer when the alarm is triggered.

**Capture License Plate:** When a license plate is detected, it will save the captured image of the license plate.

**Save Background:** When a license plate is detected, the whole preview picture will be saved.

**Show Thumbnail:** When a face is detected, the preview will have a thumbnail pop-up alert.

**Email Alert:** When an alarm is detected, it will send the captured picture to the set email address.

**FTP Picture Upload:** When the alarm is detected, the picture will be sent to the set FTP server.

**Picture to Cloud:** When an alarm is detected, a picture will be sent to the set cloud storage server.

**Event Push Platform:** When an alarm is detected, it will send an alarm message to the third-party platform that the device is connected to.

**Voice Prompts:** The audio file into which the voice prompt is imported when this alarm is triggered (requires IPC support for voice prompts).

**Alarm Schedule:** Click  to enter the setting schedule interface.

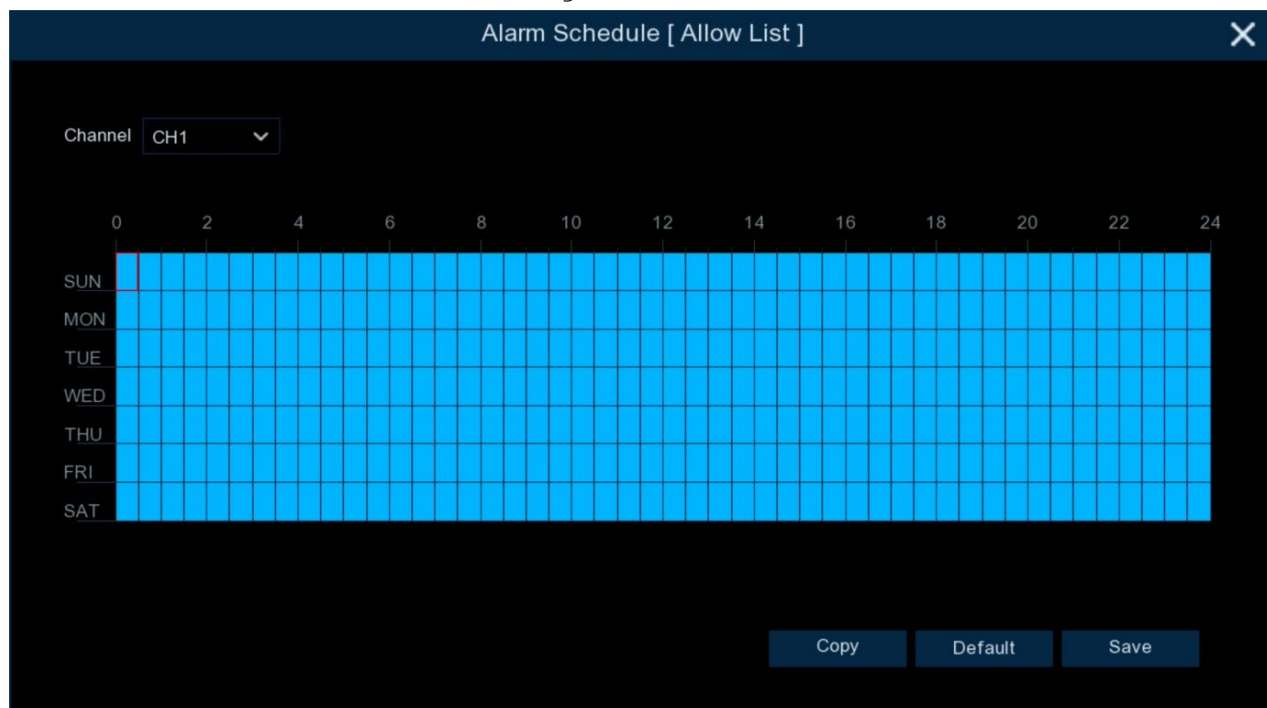

Check the time period you want to alarm [Exit](#) and click Apply. Copy can be copied to other channels.

**Alarm Channel:** Set the channel for Trigger when the face is detected and compared successfully.

### 5.4.3.5 Pedestrian & Vehicle Detection Alarm Settings

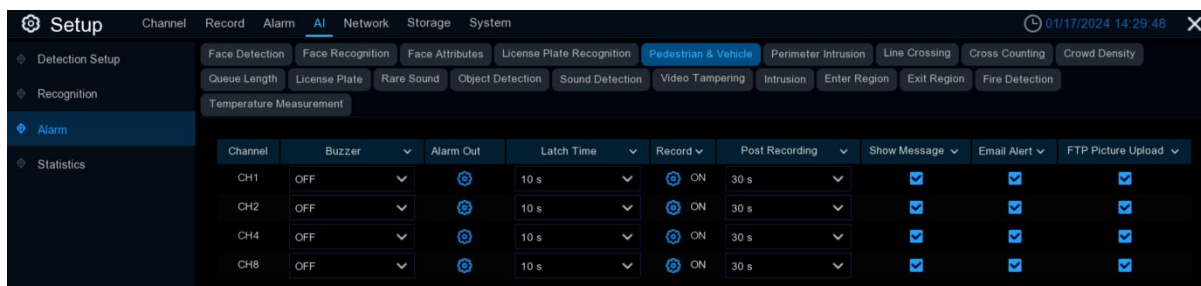

**Channel:** Channel name

**Buzzer:** The DVR can use its internal buzzer to sound an alarm tone. Set the duration (in seconds) of the buzzer when the alarm is triggered.

**Alarm out:** optional function. the DVR supports connecting to an external alarm device, then you can set the external alarm device.

**Latch Time:** Set the external alarm time when the alarm is detected.

**Record:** Click the  icon to select the channel to be recorded when the alarm is triggered.



**Post Recording:** Set the length of time the DVR will continue to record after an event. The recommended recording time is 30 seconds, but can be set to a maximum of 5 minutes.

**Show Message:** Check this box to display the AA icon on the live display screen when an alarm is detected.

**Email Alert:** When an alarm is detected, a capture image will be sent to the set email address.

**FTP Picture Upload:** When an alarm is detected, a picture will be sent to the set FTP server.

**FTP Video Upload:** When the alarm is detected, the video will be sent to the set FTP server.

**Picture to Cloud:** When the alarm is detected, it will send the captured picture to the set cloud storage server.

**Video to Cloud:** Send video to the set cloud storage server when an alarm is detected.

**Full Screen:** If this feature is enabled and an alarm is detected in a channel, the channel will be previewed in full screen mode.

**Event Push Platform:** When an alarm is detected, an alert message will be sent to the third party platform that the device is connected to.

**Voice Prompts:** The audio file into which the voice prompt is imported when this alarm is triggered (requires IPC support for voice prompts).

### 5.4.3.6 Perimeter Intrusion Alarm Settings

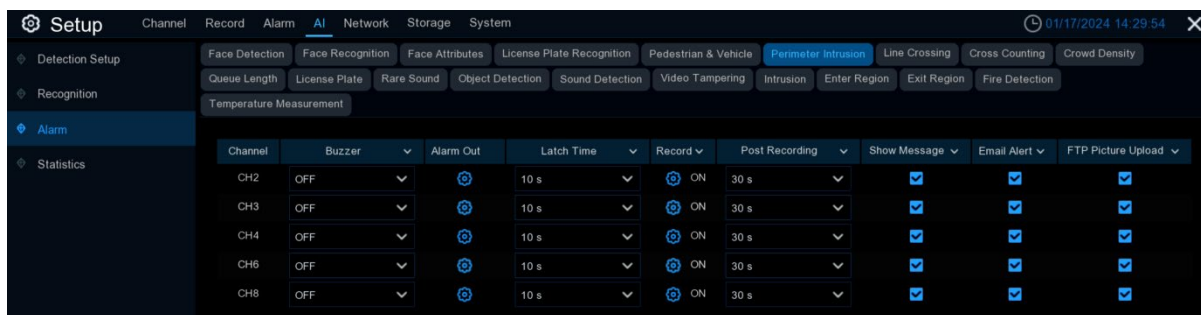

**Channel:** Channel name

**Buzzer:** The DVR can use its internal buzzer to sound an alarm tone. Set the duration (in seconds) of the buzzer when the alarm is triggered.

**Alarm out:** optional function. the DVR supports connecting to an external alarm device, then you can set the external alarm device.

**Latch Time:** Set the external alarm time when the alarm is detected.

**Record:** Click the icon to select the channel to be recorded when the alarm is triggered.



**Post Recording:** Set the length of time the DVR will continue to record after an event. The recommended recording time is 30 seconds, but can be set to a maximum of 5 minutes.

**Show Message:** Check this box to display the icon on the live display screen when an alarm is detected.

**Email Alert:** When an alarm is detected, a capture image will be sent to the set email address.

**FTP Picture Upload:** When an alarm is detected, a picture will be sent to the set FTP server.

**FTP Video Upload:** When the alarm is detected, the video will be sent to the set FTP server.

**Picture to Cloud:** When the alarm is detected, it will send the captured picture to the set cloud storage server.

**Video to Cloud:** Send video to the set cloud storage server when an alarm is detected.

**Full Screen:** If this feature is enabled and an alarm is detected in a channel, the channel will be previewed in full screen mode.

**Event Push Platform:** When an alarm is detected, an alert message will be sent to the third party platform that the device is connected to.

**Voice Prompts:** The audio file into which the voice prompt is imported when this alarm is triggered (requires IPC support for voice prompts).

### 5.4.3.7 Line Crossing Alarm Settings

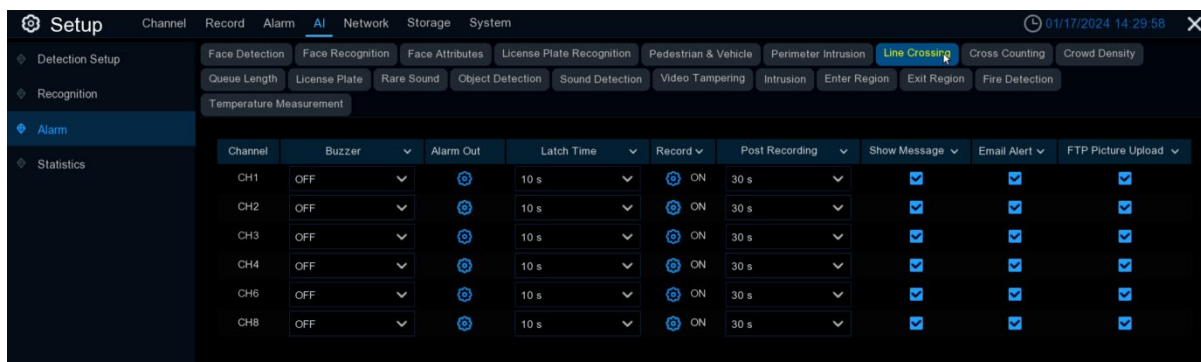

**Channel:** Channel name

**Buzzer:** The DVR can use its internal buzzer to sound an alarm tone. Set the duration (in seconds) of the buzzer when the alarm is triggered.

**Alarm out:** optional function. the DVR supports connecting to an external alarm device, then you can set the external alarm device.

**Latch Time:** Set the external alarm time when the alarm is detected.

**Record:** Click the icon to select the channel to be recorded when the alarm is triggered.



**Post Recording:** Set the length of time the DVR will continue to record after an event. The recommended recording time is 30 seconds, but can be set to a maximum of 5 minutes.

**Show Message:** Check this box to display the icon on the live display screen when an alarm is detected.

**Email Alert:** When an alarm is detected, a capture image will be sent to the set email address.

**FTP Picture Upload:** When an alarm is detected, a picture will be sent to the set FTP server.

**FTP Video Upload:** When the alarm is detected, the video will be sent to the set FTP server.

**Picture to Cloud:** When the alarm is detected, it will send the captured picture to the set cloud storage server.

**Video to Cloud:** Send video to the set cloud storage server when an alarm is detected.

**Full Screen:** If this feature is enabled and an alarm is detected in a channel, the channel will be previewed in full screen mode.

**Event Push Platform:** When an alarm is detected, an alert message will be sent to the third party platform that the device is connected to.

**Voice Prompts:** The audio file into which the voice prompt is imported when this alarm is triggered (requires IPC support for voice prompts).



### 5.4.3.8 Cross Counting Alarm Settings

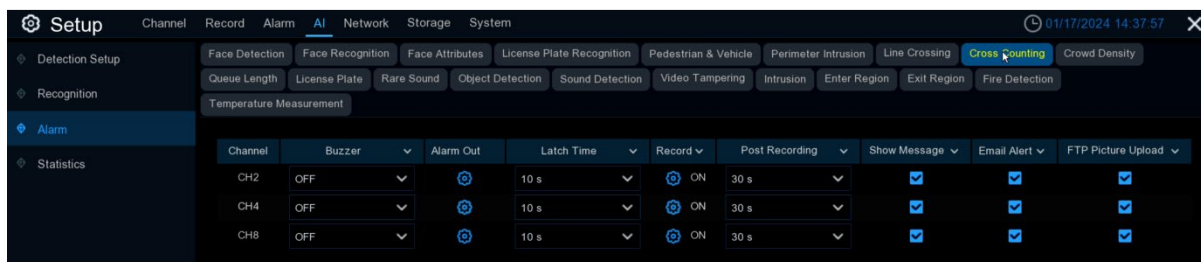

**Channel:** Channel name

**Buzzer:** The DVR can use its internal buzzer to sound an alarm tone. Set the duration (in seconds) of the buzzer when the alarm is triggered.

**Alarm out:** optional function. the DVR supports connecting to an external alarm device, then you can set the external alarm device.

**Latch Time:** Set the external alarm time when the alarm is detected.

**Record:** Click the icon to select the channel to be recorded when the alarm is triggered.

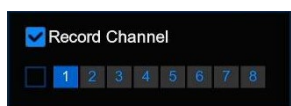

**Post Recording:** Set the length of time the DVR will continue to record after an event. The recommended recording time is 30 seconds, but can be set to a maximum of 5 minutes.

**Show Message:** Check this box to display the icon on the live display screen when an alarm is detected.

**Email Alert:** When an alarm is detected, a capture image will be sent to the set email address.

**FTP Picture Upload:** When an alarm is detected, a picture will be sent to the set FTP server.

**FTP Video Upload:** When the alarm is detected, the video will be sent to the set FTP server.

**Picture to Cloud:** When the alarm is detected, it will send the captured picture to the set cloud storage server.

**Video to Cloud:** Send video to the set cloud storage server when an alarm is detected.

**Full Screen:** If this feature is enabled and an alarm is detected in a channel, the channel will be previewed in full screen mode.

**Event Push Platform:** When an alarm is detected, an alert message will be sent to the third party platform that the device is connected to.

**Voice Prompts:** The audio file into which the voice prompt is imported when this alarm is triggered (requires IPC support for voice prompts).

### 5.4.3.9 Crowd Density Alarm Settings

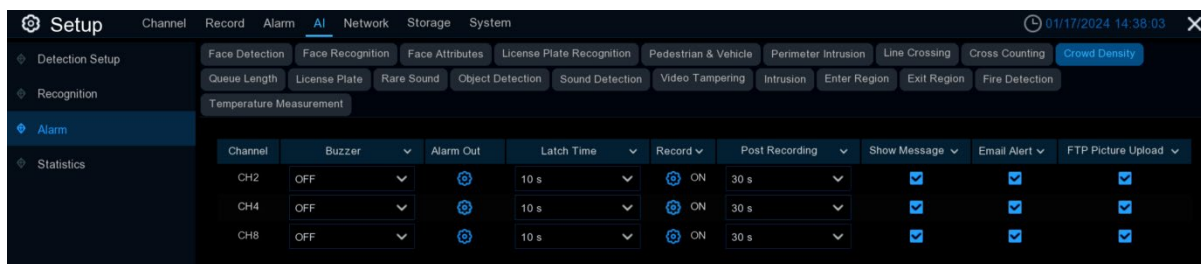

**Channel:** Channel name

**Buzzer:** The DVR can use its internal buzzer to sound an alarm tone. Set the duration (in seconds) of the buzzer when the alarm is triggered.

**Alarm out:** optional function. the DVR supports connecting to an external alarm device, then you can set the external alarm device.

**Latch Time:** Set the external alarm time when the alarm is detected.

**Record:** Click the icon to select the channel to be recorded when the alarm is triggered.

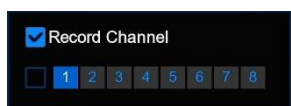

**Post Recording:** Set the length of time the DVR will continue to record after an event. The recommended recording time is 30 seconds, but can be set to a maximum of 5 minutes.

**Show Message:** Check this box to display the icon on the live display screen when an alarm is detected.

**Email Alert:** When an alarm is detected, a capture image will be sent to the set email address.

**FTP Picture Upload:** When an alarm is detected, a picture will be sent to the set FTP server.

**FTP Video Upload:** When the alarm is detected, the video will be sent to the set FTP server.

**Picture to Cloud:** When the alarm is detected, it will send the captured picture to the set cloud storage server.

**Video to Cloud:** Send video to the set cloud storage server when an alarm is detected.

**Full Screen:** If this feature is enabled and an alarm is detected in a channel, the channel will be previewed in full screen mode.

**Event Push Platform:** When an alarm is detected, an alert message will be sent to the third party platform that the device is connected to.

**Voice Prompts:** The audio file into which the voice prompt is imported when this alarm is triggered (requires IPC support for voice prompts).

### 5.4.3.10 Queue Length Alarm Settings

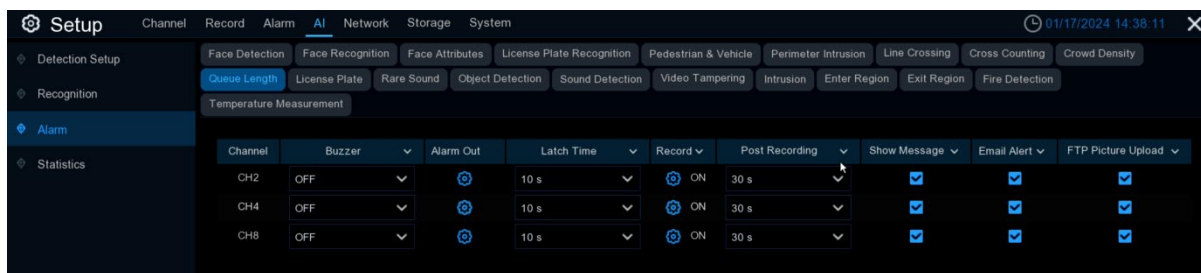

**Channel:** Channel name

**Buzzer:** The DVR can use its internal buzzer to sound an alarm tone. Set the duration (in seconds) of the buzzer when the alarm is triggered.

**Alarm out:** optional function. the DVR supports connecting to an external alarm device, then you can set the external alarm device.

**Latch Time:** Set the external alarm time when the alarm is detected.

**Record:** Click  the icon to select the channel to be recorded when the alarm is triggered.



**Post Recording:** Set the length of time the DVR will continue to record after an event. The recommended recording time is 30 seconds, but can be set to a maximum of 5 minutes.

**Show Message:** Check this box to display the  icon on the live display screen when an alarm is detected.

**Email Alert:** When an alarm is detected, a capture image will be sent to the set email address.

**FTP Picture Upload:** When an alarm is detected, a picture will be sent to the set FTP server.

**FTP Video Upload:** When the alarm is detected, the video will be sent to the set FTP server.

**Picture to Cloud:** When the alarm is detected, it will send the captured picture to the set cloud storage server.

**Video to Cloud:** Send video to the set cloud storage server when an alarm is detected.

**Full Screen:** If this feature is enabled and an alarm is detected in a channel, the channel will be previewed in full screen mode.

**Event Push Platform:** When an alarm is detected, an alert message will be sent to the third party platform that the device is connected to.

**Voice Prompts:** The audio file into which the voice prompt is imported when this alarm is triggered (requires IPC support for voice prompts).

### 5.4.3.11 Licence Plate Alarm Settings

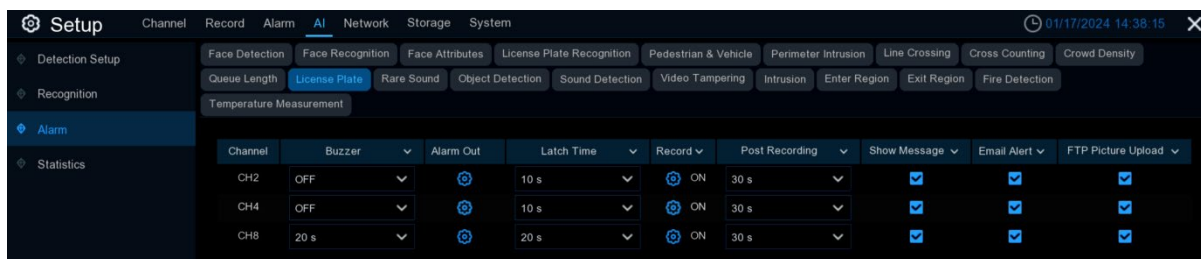

**Channel:** Channel name

**Buzzer:** The DVR can use its internal buzzer to sound an alarm tone. Set the duration (in seconds) of the buzzer when the alarm is triggered.

**Alarm out:** optional function. the DVR supports connecting to an external alarm device, then you can set the external alarm device.

**Latch Time:** Set the external alarm time when the alarm is detected.

**Record:** Click the icon to select the channel to be recorded when the alarm is triggered.

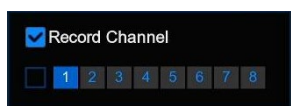

**Post Recording:** Set the length of time the DVR will continue to record after an event. The recommended recording time is 30 seconds, but can be set to a maximum of 5 minutes.

**Show Message:** Check this box to display the icon on the live display screen when an alarm is detected.

**Email Alert:** When an alarm is detected, a capture image will be sent to the set email address.

**FTP Picture Upload:** When an alarm is detected, a picture will be sent to the set FTP server.

**FTP Video Upload:** When the alarm is detected, the video will be sent to the set FTP server.

**Picture to Cloud:** When the alarm is detected, it will send the captured picture to the set cloud storage server.

**Video to Cloud:** Send video to the set cloud storage server when an alarm is detected.

**Full Screen:** If this feature is enabled and an alarm is detected in a channel, the channel will be previewed in full screen mode.

**Event Push Platform:** When an alarm is detected, an alert message will be sent to the third party platform that the device is connected to.

**Voice Prompts:** The audio file into which the voice prompt is imported when this alarm is triggered (requires IPC support for voice prompts).

### 5.4.3.12 Rare Sound Alarm Settings

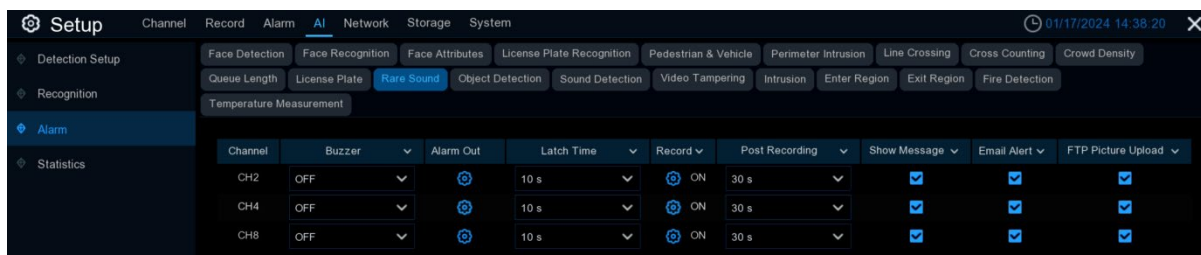

**Channel:** Channel name

**Buzzer:** The DVR can use its internal buzzer to sound an alarm tone. Set the duration (in seconds) of the buzzer when the alarm is triggered.

**Alarm out:** optional function. the DVR supports connecting to an external alarm device, then you can set the external alarm device.

**Latch Time:** Set the external alarm time when the alarm is detected.

**Record:** Click the icon to select the channel to be recorded when the alarm is triggered.



**Post Recording:** Set the length of time the DVR will continue to record after an event. The recommended recording time is 30 seconds, but can be set to a maximum of 5 minutes.

**Show Message:** Check this box to display the icon on the live display screen when an alarm is detected.

**Email Alert:** When an alarm is detected, a capture image will be sent to the set email address.

**FTP Picture Upload:** When an alarm is detected, a picture will be sent to the set FTP server.

**FTP Video Upload:** When the alarm is detected, the video will be sent to the set FTP server.

**Picture to Cloud:** When the alarm is detected, it will send the captured picture to the set cloud storage server.

**Video to Cloud:** Send video to the set cloud storage server when an alarm is detected.

**Full Screen:** If this feature is enabled and an alarm is detected in a channel, the channel will be previewed in full screen mode.

**Event Push Platform:** When an alarm is detected, an alert message will be sent to the third party platform that the device is connected to.

**Voice Prompts:** The audio file into which the voice prompt is imported when this alarm is triggered (requires IPC support for voice prompts).

### 5.4.3.13 Object Detection Alarm Settings

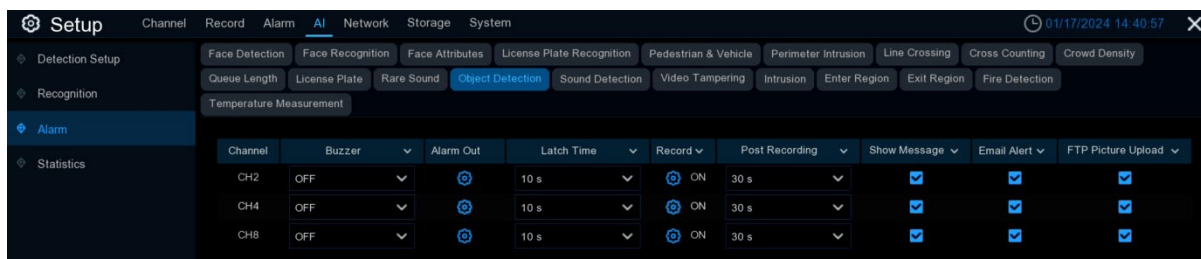

**Channel:** Channel name

**Buzzer:** The DVR can use its internal buzzer to sound an alarm tone. Set the duration (in seconds) of the buzzer when the alarm is triggered.

**Alarm out:** optional function. the DVR supports connecting to an external alarm device, then you can set the external alarm device.

**Latch Time:** Set the external alarm time when the alarm is detected.

**Record:** Click  the icon to select the channel to be recorded when the alarm is triggered.

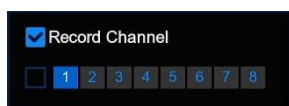

**Post Recording:** Set the length of time the DVR will continue to record after an event. The recommended recording time is 30 seconds, but can be set to a maximum of 5 minutes.

**Show Message:** Check this box to display the  icon on the live display screen when an alarm is detected.

**Email Alert:** When an alarm is detected, a capture image will be sent to the set email address.

**FTP Picture Upload:** When an alarm is detected, a picture will be sent to the set FTP server.

**FTP Video Upload:** When the alarm is detected, the video will be sent to the set FTP server.

**Picture to Cloud:** When the alarm is detected, it will send the captured picture to the set cloud storage server.

**Video to Cloud:** Send video to the set cloud storage server when an alarm is detected.

**Full Screen:** If this feature is enabled and an alarm is detected in a channel, the channel will be previewed in full screen mode.

**Event Push Platform:** When an alarm is detected, an alert message will be sent to the third party platform that the device is connected to.

**Voice Prompts:** The audio file into which the voice prompt is imported when this alarm is triggered (requires IPC support for voice prompts).

### 5.4.3.14 Sound Detection Settings

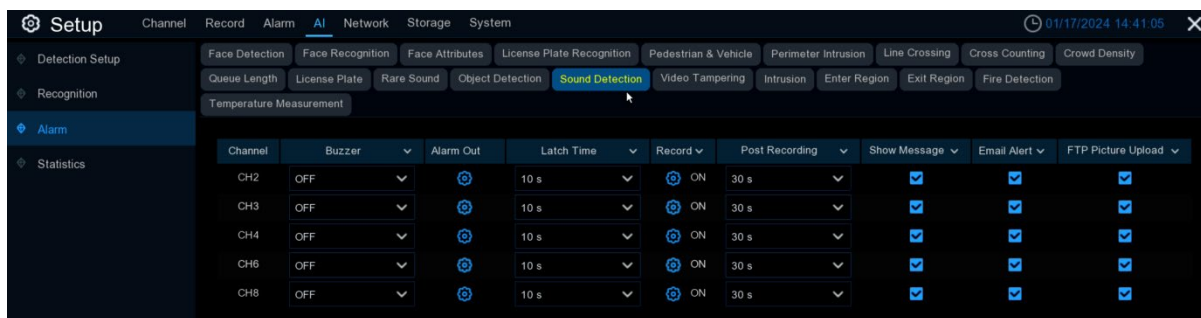

**Channel:** Channel name

**Buzzer:** The DVR can use its internal buzzer to sound an alarm tone. Set the duration (in seconds) of the buzzer when the alarm is triggered.

**Alarm out:** optional function. the DVR supports connecting to an external alarm device, then you can set the external alarm device.

**Latch Time:** Set the external alarm time when the alarm is detected.

**Record:** Click the icon to select the channel to be recorded when the alarm is triggered.

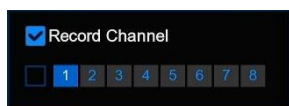

**Post Recording:** Set the length of time the DVR will continue to record after an event. The recommended recording time is 30 seconds, but can be set to a maximum of 5 minutes.

**Show Message:** Check this box to display the icon on the live display screen when an alarm is detected.

**Email Alert:** When an alarm is detected, a capture image will be sent to the set email address.

**FTP Picture Upload:** When an alarm is detected, a picture will be sent to the set FTP server.

**FTP Video Upload:** When the alarm is detected, the video will be sent to the set FTP server.

**Picture to Cloud:** When the alarm is detected, it will send the captured picture to the set cloud storage server.

**Video to Cloud:** Send video to the set cloud storage server when an alarm is detected.

**Full Screen:** If this feature is enabled and an alarm is detected in a channel, the channel will be previewed in full screen mode.

**Event Push Platform:** When an alarm is detected, an alert message will be sent to the third party platform that the device is connected to.

**Voice Prompts:** The audio file into which the voice prompt is imported when this alarm is triggered (requires IPC support for voice prompts).

### 5.4.3.15 Video Tampering Alarm Settings

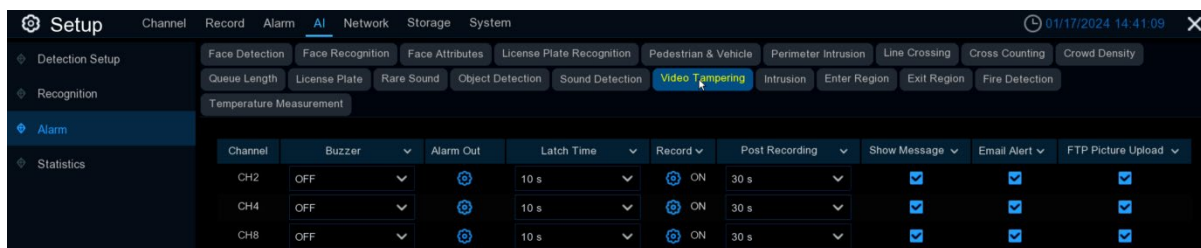

**Channel:** Channel name

**Buzzer:** The DVR can use its internal buzzer to sound an alarm tone. Set the duration (in seconds) of the buzzer when the alarm is triggered.

**Alarm out:** optional function. the DVR supports connecting to an external alarm device, then you can set the external alarm device.

**Latch Time:** Set the external alarm time when the alarm is detected.

**Record:** Click the icon to select the channel to be recorded when the alarm is triggered.



**Post Recording:** Set the length of time the DVR will continue to record after an event. The recommended recording time is 30 seconds, but can be set to a maximum of 5 minutes.

**Show Message:** Check this box to display the icon on the live display screen when an alarm is detected.

**Email Alert:** When an alarm is detected, a capture image will be sent to the set email address.

**FTP Picture Upload:** When an alarm is detected, a picture will be sent to the set FTP server.

**FTP Video Upload:** When the alarm is detected, the video will be sent to the set FTP server.

**Picture to Cloud:** When the alarm is detected, it will send the captured picture to the set cloud storage server.

**Video to Cloud:** Send video to the set cloud storage server when an alarm is detected.

**Full Screen:** If this feature is enabled and an alarm is detected in a channel, the channel will be previewed in full screen mode.

**Event Push Platform:** When an alarm is detected, an alert message will be sent to the third party platform that the device is connected to.

**Voice Prompts:** The audio file into which the voice prompt is imported when this alarm is triggered (requires IPC support for voice prompts).



### 5.4.3.16 Intrusion Alarm Settings

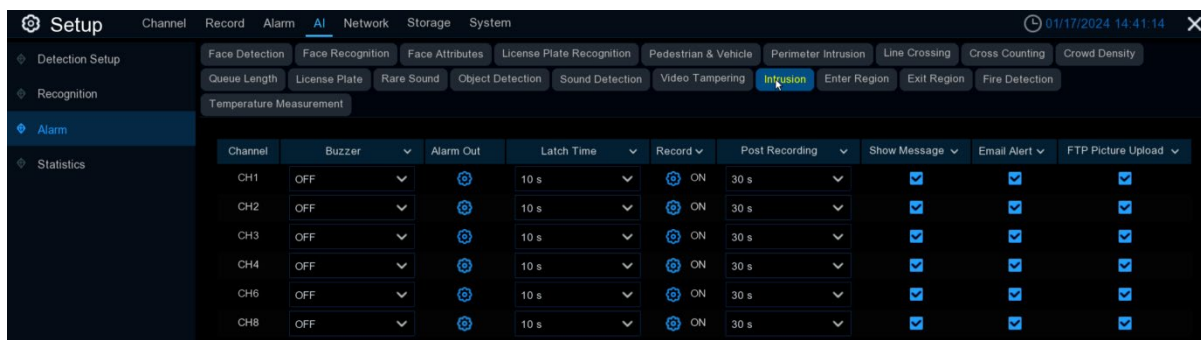

**Channel:** Channel name

**Buzzer:** The DVR can use its internal buzzer to sound an alarm tone. Set the duration (in seconds) of the buzzer when the alarm is triggered.

**Alarm out:** optional function. the DVR supports connecting to an external alarm device, then you can set the external alarm device.

**Latch Time:** Set the external alarm time when the alarm is detected.

**Record:** Click the icon to select the channel to be recorded when the alarm is triggered.



**Post Recording:** Set the length of time the DVR will continue to record after an event. The recommended recording time is 30 seconds, but can be set to a maximum of 5 minutes.

**Show Message:** Check this box to display the icon on the live display screen when an alarm is detected.

**Email Alert:** When an alarm is detected, a capture image will be sent to the set email address.

**FTP Picture Upload:** When an alarm is detected, a picture will be sent to the set FTP server.

**FTP Video Upload:** When the alarm is detected, the video will be sent to the set FTP server.

**Picture to Cloud:** When the alarm is detected, it will send the captured picture to the set cloud storage server.

**Video to Cloud:** Send video to the set cloud storage server when an alarm is detected.

**Full Screen:** If this feature is enabled and an alarm is detected in a channel, the channel will be previewed in full screen mode.

**Event Push Platform:** When an alarm is detected, an alert message will be sent to the third party platform that the device is connected to.

**Voice Prompts:** The audio file into which the voice prompt is imported when this alarm is triggered (requires IPC support for voice prompts).

### 5.4.3.17 Enter Region Alarm Settings

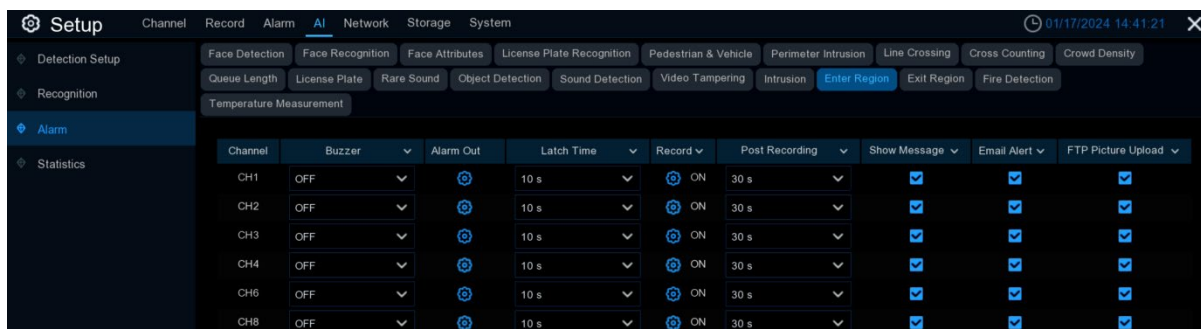

**Channel:** Channel name

**Buzzer:** The DVR can use its internal buzzer to sound an alarm tone. Set the duration (in seconds) of the buzzer when the alarm is triggered.

**Alarm out:** optional function. the DVR supports connecting to an external alarm device, then you can set the external alarm device.

**Latch Time:** Set the external alarm time when the alarm is detected.

**Record:** Click  the icon to select the channel to be recorded when the alarm is triggered.



**Post Recording:** Set the length of time the DVR will continue to record after an event. The recommended recording time is 30 seconds, but can be set to a maximum of 5 minutes.

**Show Message:** Check this box to display the  icon on the live display screen when an alarm is detected.

**Email Alert:** When an alarm is detected, a capture image will be sent to the set email address.

**FTP Picture Upload:** When an alarm is detected, a picture will be sent to the set FTP server.

**FTP Video Upload:** When the alarm is detected, the video will be sent to the set FTP server.

**Picture to Cloud:** When the alarm is detected, it will send the captured picture to the set cloud storage server.

**Video to Cloud:** Send video to the set cloud storage server when an alarm is detected.

**Full Screen:** If this feature is enabled and an alarm is detected in a channel, the channel will be previewed in full screen mode.

**Event Push Platform:** When an alarm is detected, an alert message will be sent to the third party platform that the device is connected to.

**Voice Prompts:** The audio file into which the voice prompt is imported when this alarm is triggered (requires IPC support for voice prompts).

### 5.4.3.18 Exit Region Alarm Settings

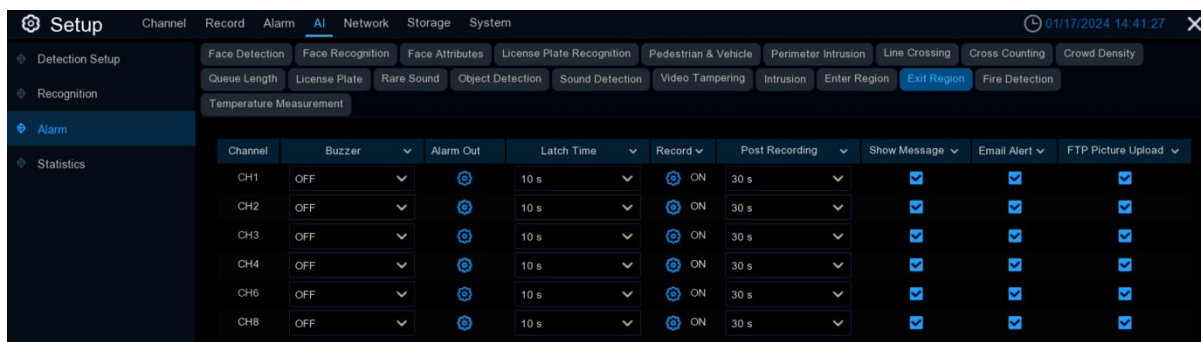

**Channel:** Channel name

**Buzzer:** The DVR can use its internal buzzer to sound an alarm tone. Set the duration (in seconds) of the buzzer when the alarm is triggered.

**Alarm out:** Optional function. the DVR supports connecting to an external alarm device, then you can set the external alarm device.

**Latch Time:** Set the external alarm time when the alarm is detected.

**Record:** Click the icon to select the channel to be recorded when the alarm is triggered.



**Post Recording:** Set the length of time the DVR will continue to record after an event. The recommended recording time is 30 seconds, but can be set to a maximum of 5 minutes.

**Show Message:** Check this box to display the icon on the live display screen when an alarm is detected.

**Email Alert:** When an alarm is detected, a capture image will be sent to the set email address.

**FTP Picture Upload:** When an alarm is detected, a picture will be sent to the set FTP server.

**FTP Video Upload:** When the alarm is detected, the video will be sent to the set FTP server.

**Picture to Cloud:** When the alarm is detected, it will send the captured picture to the set cloud storage server.

**Video to Cloud:** Send video to the set cloud storage server when an alarm is detected.

**Full Screen:** If this feature is enabled and an alarm is detected in a channel, the channel will be previewed in full screen mode.

**Event Push Platform:** When an alarm is detected, an alert message will be sent to the third party platform that the device is connected to.

**Voice Prompts:** The audio file into which the voice prompt is imported when this alarm is triggered (requires IPC support for voice prompts).

### 5.4.3.19 Fire Detection Alarm Settings ( need to connect a thermal camera)

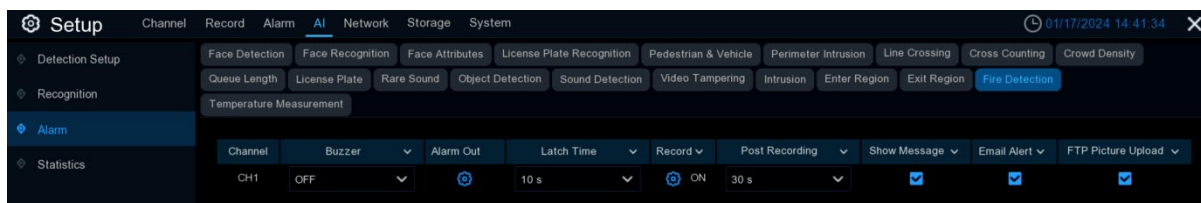

**Channel:** Channel name

**Buzzer:** The DVR can use its internal buzzer to sound an alarm tone. Set the duration (in seconds) of the buzzer when the alarm is triggered.

**Alarm out:** optional function. the DVR supports connecting to an external alarm device, then you can set the external alarm device.

**Latch Time:** Set the external alarm time when the alarm is detected.

**Record:** Click  the icon to select the channel to be recorded when the alarm is triggered.



**Post Recording:** Set the length of time the DVR will continue to record after an event. The recommended recording time is 30 seconds, but can be set to a maximum of 5 minutes.

**Show Message:** Check this box to display the  icon on the live display screen when an alarm is detected.

**Email Alert:** When an alarm is detected, a capture image will be sent to the set email address.

**FTP Picture Upload:** When an alarm is detected, a picture will be sent to the set FTP server.

**FTP Video Upload:** When the alarm is detected, the video will be sent to the set FTP server.

**Picture to Cloud:** When the alarm is detected, it will send the captured picture to the set cloud storage server.

**Video to Cloud:** Send video to the set cloud storage server when an alarm is detected.

**Full Screen:** If this feature is enabled and an alarm is detected in a channel, the channel will be previewed in full screen mode.

**Event Push Platform:** When an alarm is detected, an alert message will be sent to the third party platform that the device is connected to.

**Voice Prompts:** The audio file into which the voice prompt is imported when this alarm is triggered (requires IPC support for voice prompts).

### 5.4.3.20 Temperature measurement alarm settings ( need to connect a thermal camera )

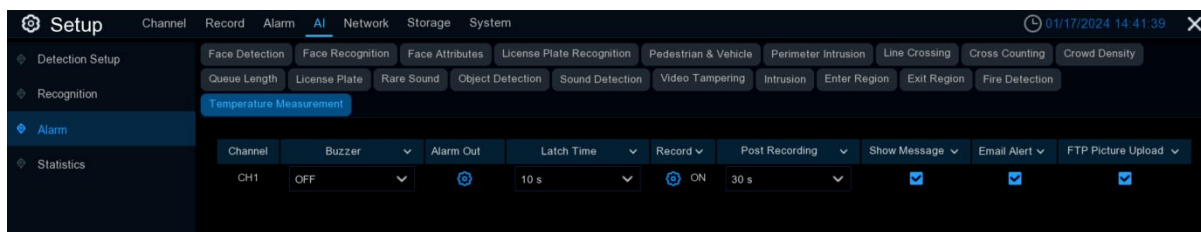

**Channel:** Channel name

**Buzzer:** The DVR can use its internal buzzer to sound an alarm tone. Set the duration (in seconds) of the buzzer when the alarm is triggered.

**Alarm out:** optional function. the DVR supports connecting to an external alarm device, then you can set the external alarm device.

**Latch Time:** Set the external alarm time when the alarm is detected.

**Record:** Click  the icon to select the channel to be recorded when the alarm is triggered.



**Post Recording:** Set the length of time the DVR will continue to record after an event. The recommended recording time is 30 seconds, but can be set to a maximum of 5 minutes.

**Show Message:** Check this box to display the  icon on the live display screen when an alarm is detected.

**Email Alert:** When an alarm is detected, a capture image will be sent to the set email address.

**FTP Picture Upload:** When an alarm is detected, a picture will be sent to the set FTP server.

**FTP Video Upload:** When the alarm is detected, the video will be sent to the set FTP server.

**Picture to Cloud:** When the alarm is detected, it will send the captured picture to the set cloud storage server.

**Video to Cloud:** Send video to the set cloud storage server when an alarm is detected.

**Full Screen:** If this feature is enabled and an alarm is detected in a channel, the channel will be previewed in full screen mode.

**Event Push Platform:** When an alarm is detected, an alert message will be sent to the third party platform that the device is connected to.

**Voice Prompts:** The audio file into which the voice prompt is imported when this alarm is triggered (requires IPC support for voice prompts).

## 5.4.4 Statistics

### 5.4.4.1 FR Statistics

In the face statistics, the faces can be all detected in a period of time, and reflected in the form of a statistical chart.

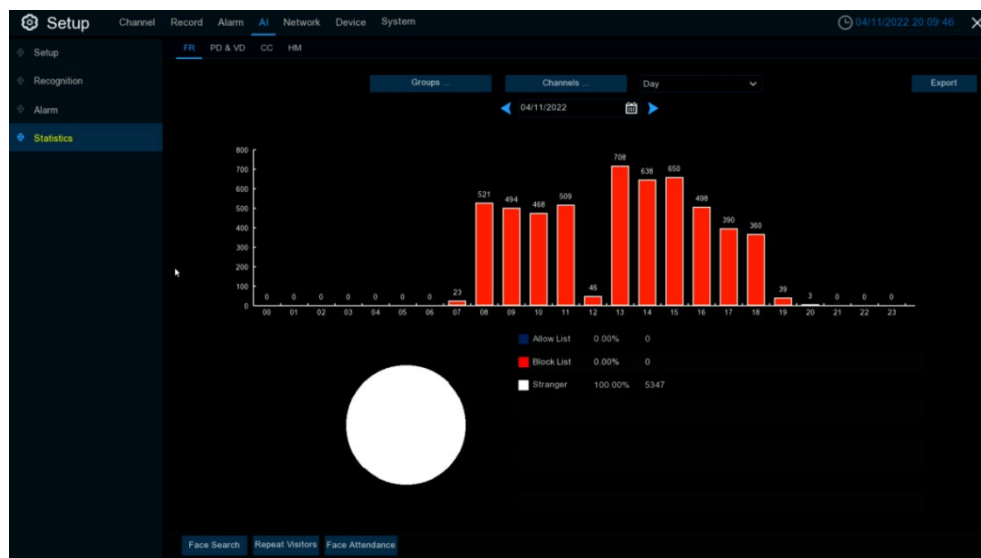

Select **Groups**, **Channels**, date and statistical time to search results. Click **Export** to import the data to U disk.

### 5.4.4.2 Pedestrian & Vehicle Statistics

In the statistics of people and cars, all the detected people and cars in a period of time can be counted and reflected in the form of statistical diagram.



Selecting **Intelligent** Groups, Channels, date and statistical time to search result.

### 5.4.4.3 Cross Counting Statistics

In the statistics of people and cars, all the detected people and cars in a period of time can be counted and reflected in the form of statistical diagram.

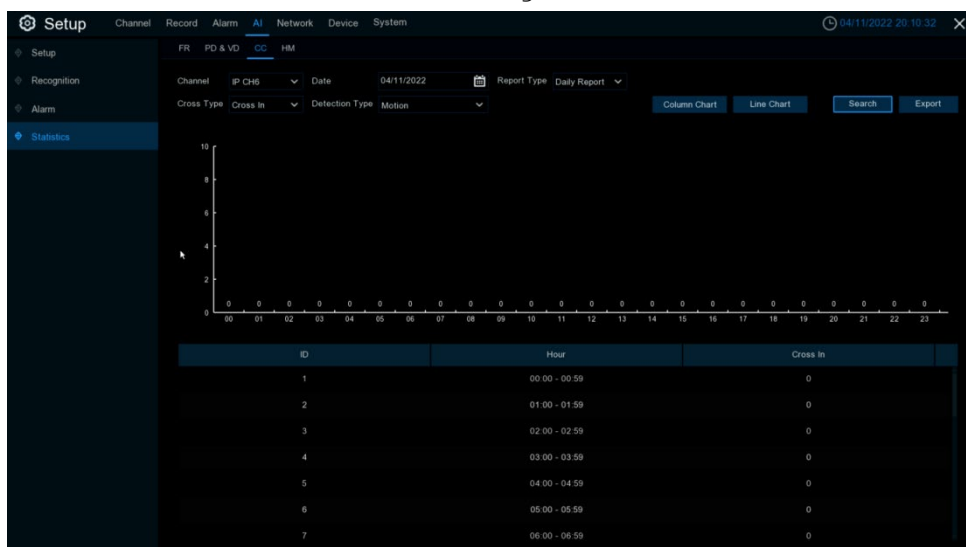

**Channel:** Select channels

**Date:** Select the date

**Report Type:** Select report type, there are Daily Report, Weekly Report, Monthly Report, Annual Report.

**Cross Type:** Crossing type, there are Cross and Cross Out.

**Detection Type:** Select the detection type that triggers Cross Counting, there are Motion, Person, Vehicle.

Click **search** to search the result.

**Export:** The result export to external USB drive.

Select **Column Chart** to show as below picture.

Select **Line Chart** to show as below picture.

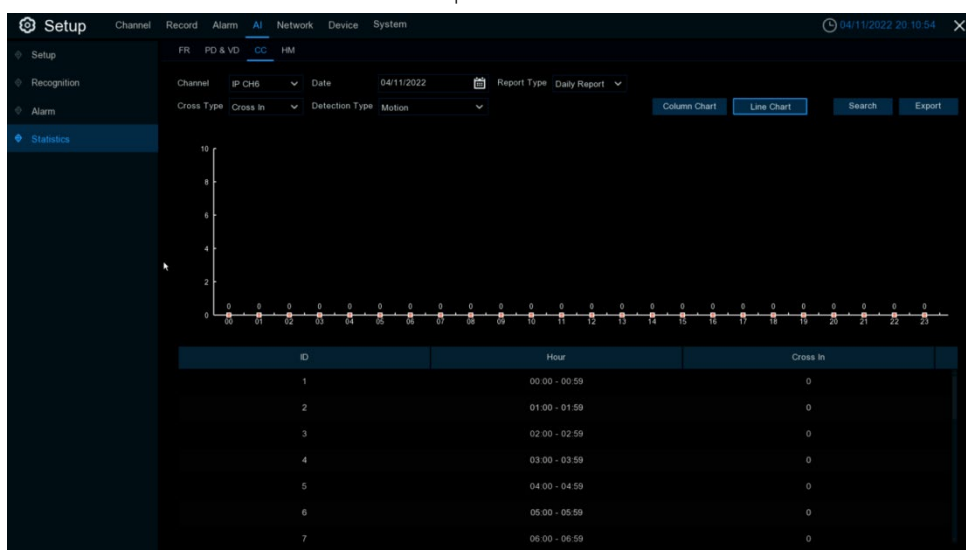

### 5.4.4.4 Heat Map Statistics

In the heat chart statistics, the frequent activity of some areas can be counted over a period of time and reflected in the form of statistical chart.

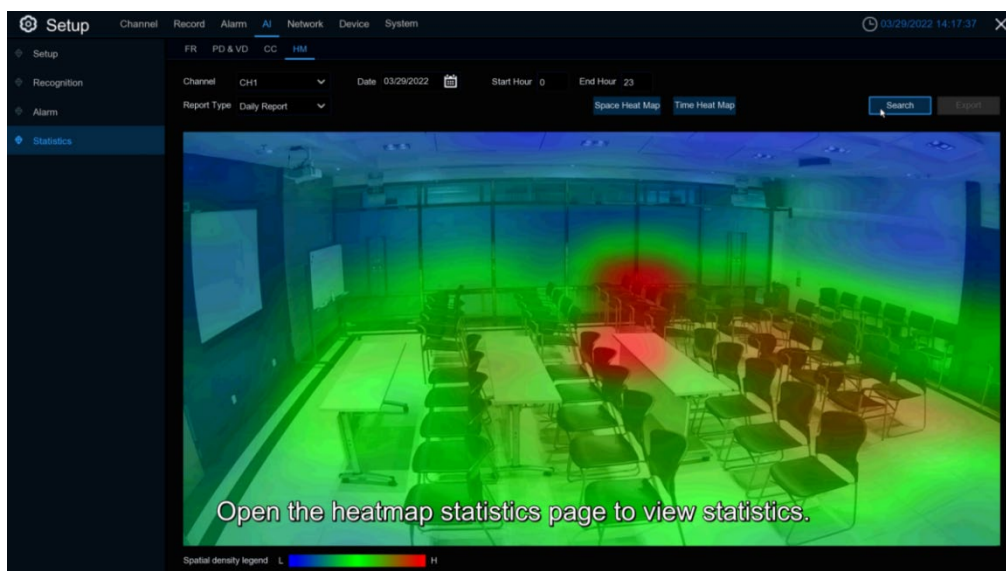

**Channel:** Select channel

**Date:** Select date

**Start Hour:** Select the start time

**End Hour:** Select the end time

**Report Type:** report type, there are Daily Report, Weekly Report, Monthly Report, Annual Report.

Click **Search** to search the result.

**Export:** export the result to USB

Select **Space Heat Map** as upper picture shows

Select **Time Heat Map** as below picture shows

Select time heat map type has **Start Hour** and **End Hour**.

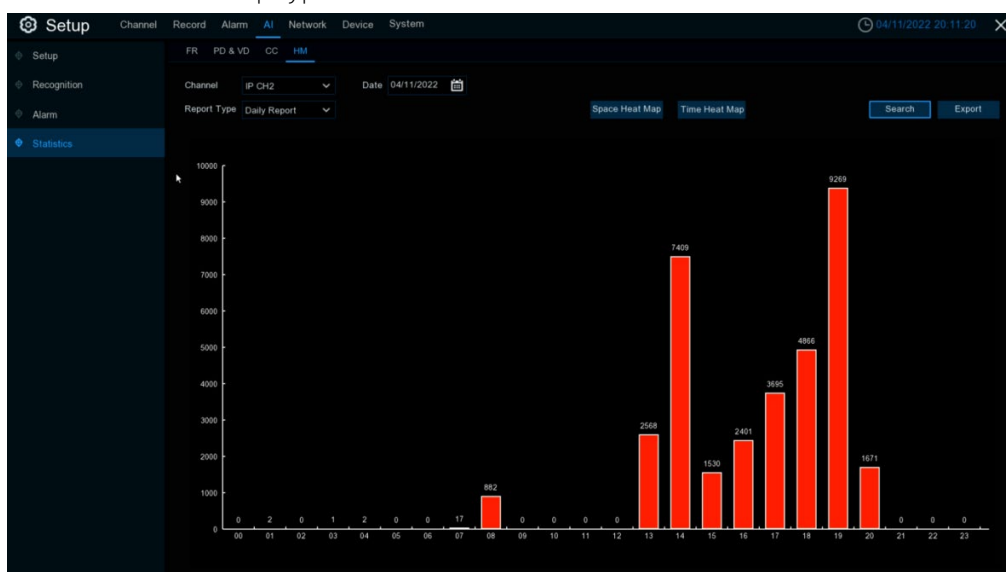



## 5.5 Network

This menu allows you to configure network parameters, such as PPPoE, DHCP, and so on. The most common types are DHCP. Most probably your network type is DHCP, unless the network is manually addressed. If you need an authentication user name and password to the Internet, then choose PPPoE.

### 5.5.1 General

#### 5.5.1.1 General

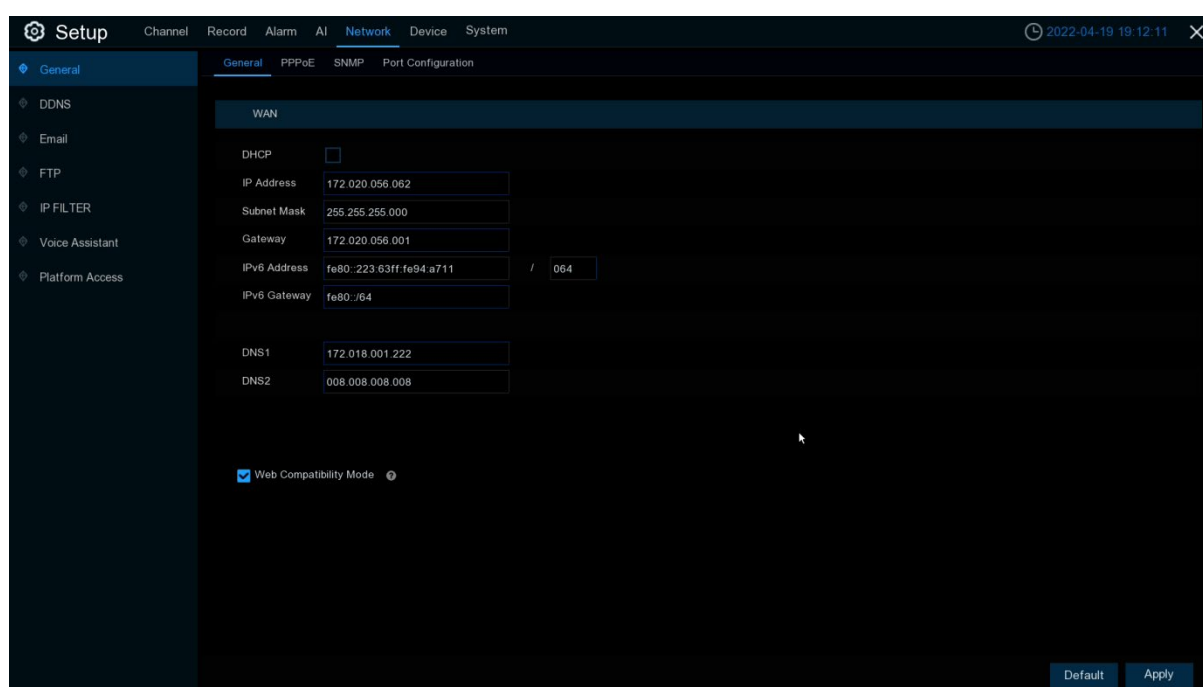

If you connect to a router allows to use DHCP, please check the **DHCP** box. The router will assign automatically all the network parameters for your DVR. Unless the network is manually addressed below parameters:

**IP Address:** The IP address identifies the DVR in the network. It consists of four groups of numbers between 0 to 255, separated by periods. For example, "192.168.001.100" .

**Subnet Mask:** Subnet mask is a network parameter which defines a range of IP addresses that can be used in a network. If IP address is like a street where you live then subnet mask is like a neighborhood. The subnet address also consists of four groups of numbers, separated by periods. For example, "255.255.000.000" .

**Gateway:** This address allows the DVR to access the Internet. The format of the **Gateway** address is the same as the **IP Address**. For example, “192.168.001.001” .

**IPv6 Address:** Please fill the IPv6 address to be set if your network support IPv6.

**IPv6 Gateway:** Please fill the gateway to be set if your network support IPv6. Format like “ABCD: EF01: 2345: 6789: ABCD: EF01: 2345: 6789” .

**DNS1/DNS2:** DNS1 is the primary DNS server and DNS2 is a backup DNS server. Usually should be enough just to enter the DNS1 server address.

**Web Compatibility Mode:** If you login of the Win7 system PC after turning on the **HTTPS**, you need to check this item to switch to the **HTTPS** page

### 5.5.1.2 PPPoE

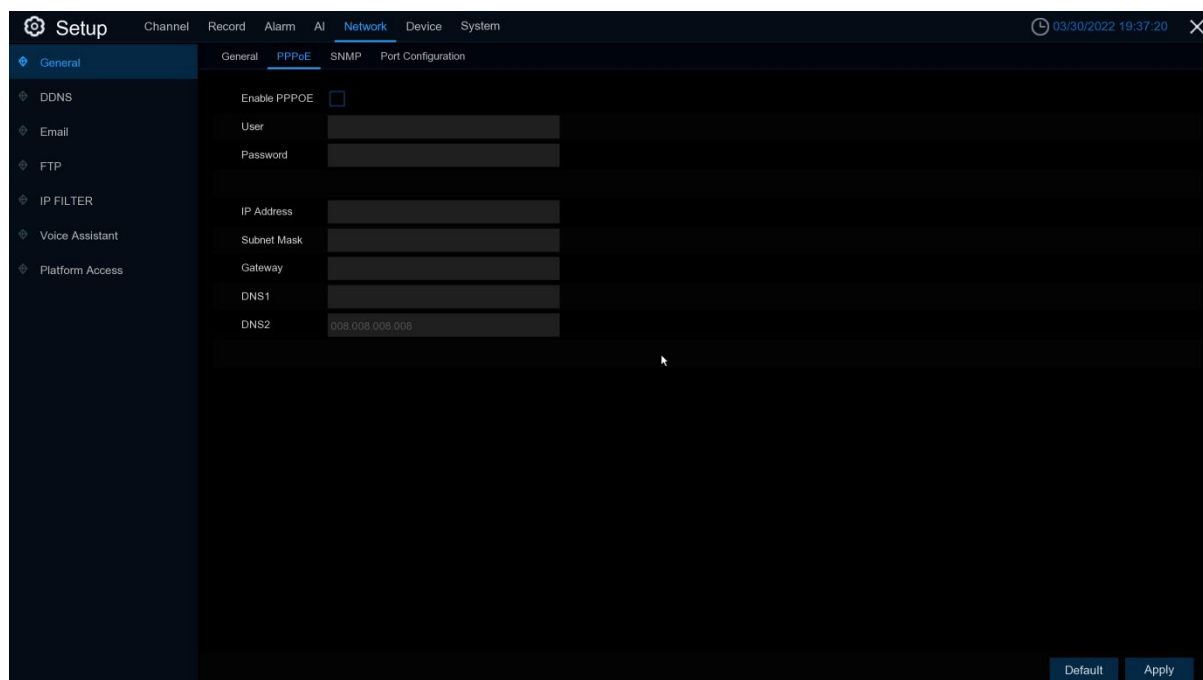

This is an advanced protocol that allows the DVR to connect to the network more directly via DSL modem.

Check the “Enable PPPOE” box, and then enter the User name & Password of the PPPoE.

Click **Apply** to save, system will reboot to active the PPPoE setting.

### 5.5.1.3 SNMP

Simple Network Management Protocol (SNMP) is a standard application layer protocol designed for IP networks to manage network nodes (like servers, workstations, routers, switches, and HUBS). Only available for some models which firmware support.

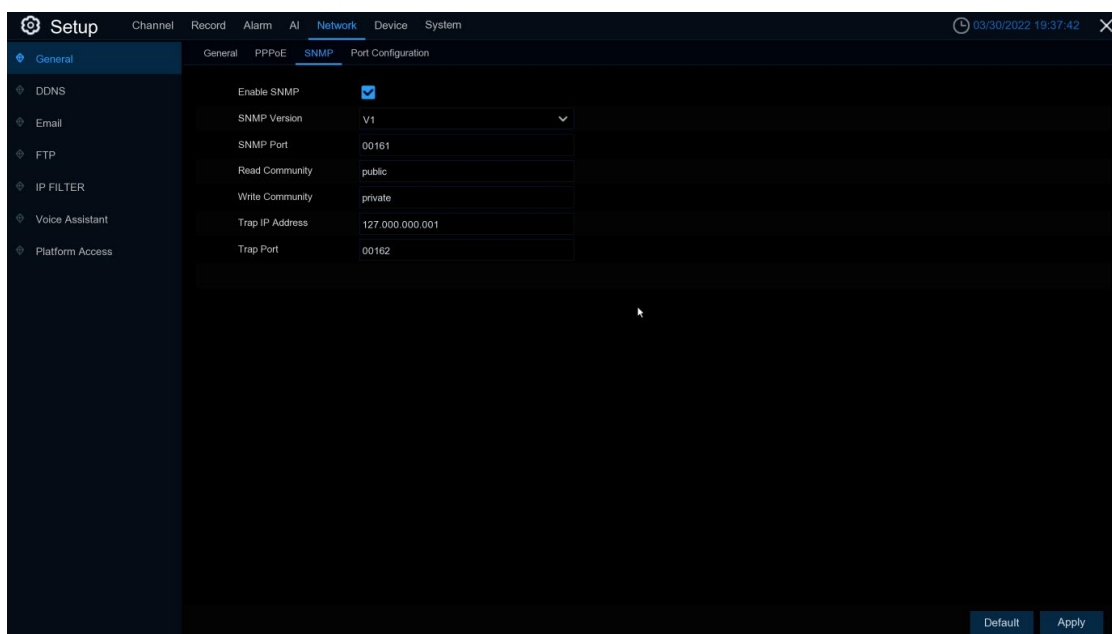

Enabled SNMP, you can obtain some of the DVR information through the SNMP protocol, such as the software version of DVR, device type, channel IP, resolution, frame number, etc.

### 5.5.1.4 Port Configuration

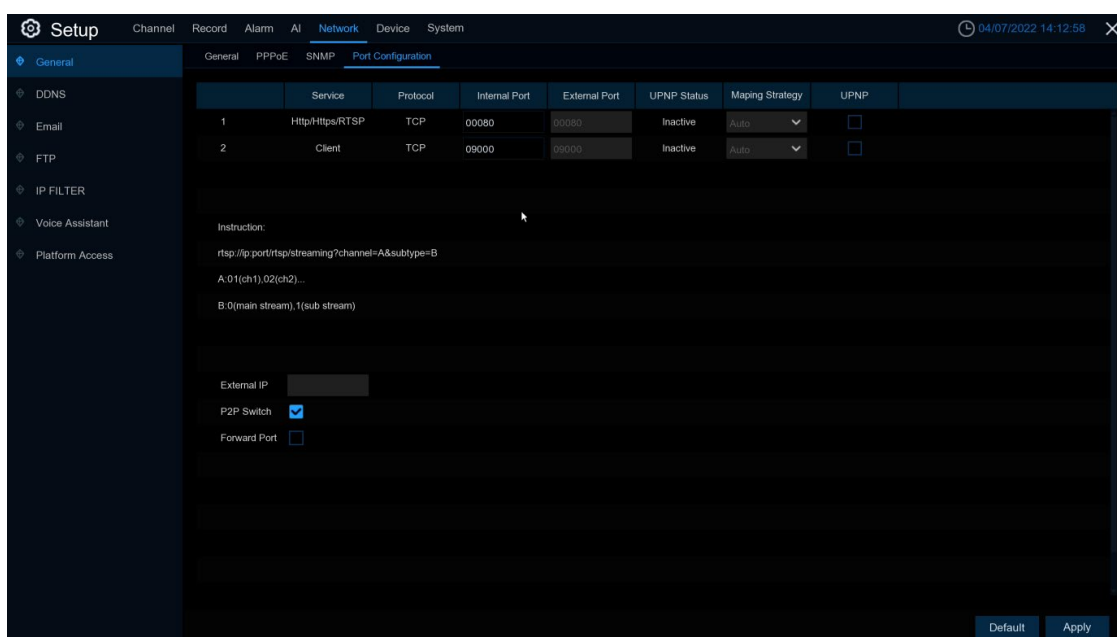

**Web Port:** This is the port that you will use to log in remotely to the DVR (e.g. using the Web Client). If the default port 80 is already taken by other applications, please change it.

**Client Port:** This is the port that the DVR will use to send information through. If the default port 9000 is already taken by other applications, please change it.

**RTSP Port:** DVR is allowed to transport real time streams to other device via RTSP port. (e.g. VLC player)

**Https Port :** Https port ---Web browsing ports are mainly used for HTTPS services. It is another HTTP that provides encryption and transmission through the security port.

**Note:** 8.2.2 version is common port, HTTP port, RTSP port, and HTTPS port to share one port, and the default is 80.

**UPNP:** If you want to log in remotely to the DVR using Web Client, you need to complete the port forwarding. Enable this option if your router supports the UPNP. You need to enable UPNP both, on DVR and router. In this case, you do not need to configure manually port forwarding on your router. If your router does not support UPNP, make sure the port forwarding is completed manually.

**Mapping Strategy:** Switch to Manual mode, you can set up **External Port** manually.

**P2P Switch:** P2P connection can't work once switch disable..

**Forward Port:** The IPC hyperlink switch can access the IPC web page through the hyperlink on the web of the DVR. At present, only the web port is launched or listed through search, and the IPC that supports API can use the hyperlink to access.

## 5.5.2 DDNS (Dynamic Domain name server)

This menu allows you to configure DDNS settings. The DDNS provides a static address to simplify remote connection to your DVR. To use the DDNS, you first need to open an account on the DDNS service provider's web page.

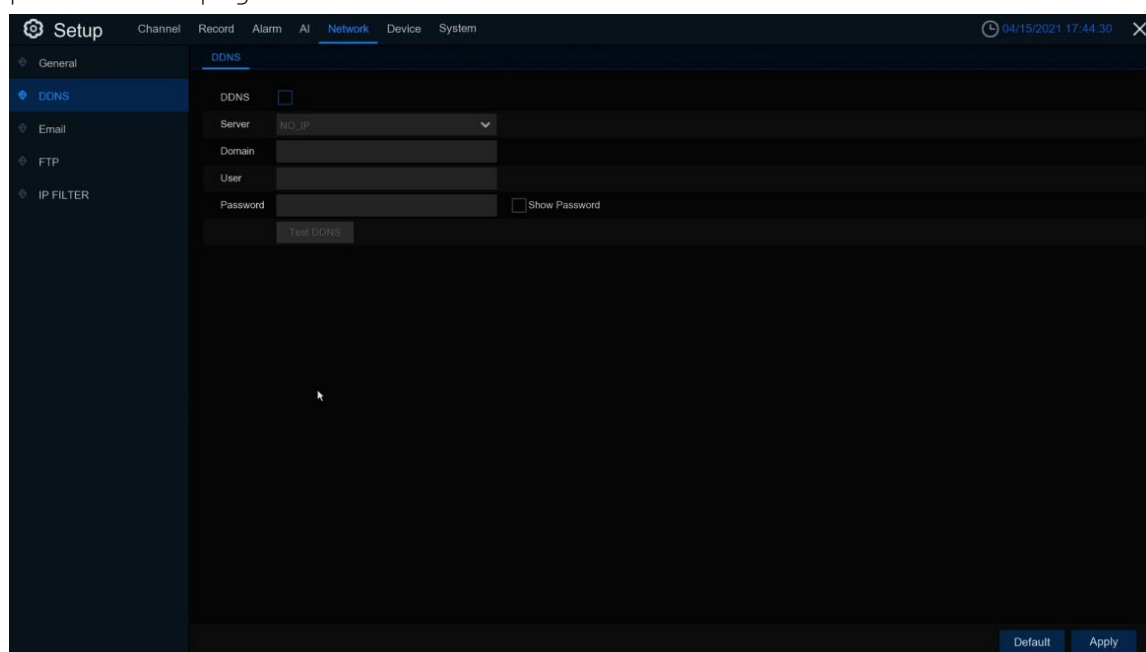

**DDNS:** Check to enable DDNS.

**Server:** Select the preferred DDNS server (DDNS\_3322, DYNDNS, NO\_IP, CHANGEIP, DNSEXIT).

**Domain:** Enter the domain name you created on the DDNS service provider’s web page. This will be the address you type in the URL box when you want to connect remotely to the DVR via PC. For example, dvr.no-ip.org.

**User/Password:** Enter the user name and password you obtained when creating an account on the DDNS service provider’s web page.

After all parameters are entered, click **Test DDNS** to test the DDNS settings. If the test result is “Network is unreachable or DNS is incorrect” , please check whether the network works fine, or the DDNS information is correct or not.

After user applies for a dynamic domain name service, you can use browser to remotely access DVR through the domain name, forming the domain name of <http://DDNS: the web port of the mapping/>. When the DDNS domain name is used to access the DVR, you need to confirm the port and the current IP can be connected normally on the public network. The server address/host name/user name/password/setting is consistent with the DVR local settings.

### 5.5.3 Email

This menu allows you to configure email settings. Please complete these settings if you want to receive the system notifications on your email when an alarm is triggered, HDD becomes full, HDD is in error state, or Video Loss occurs.

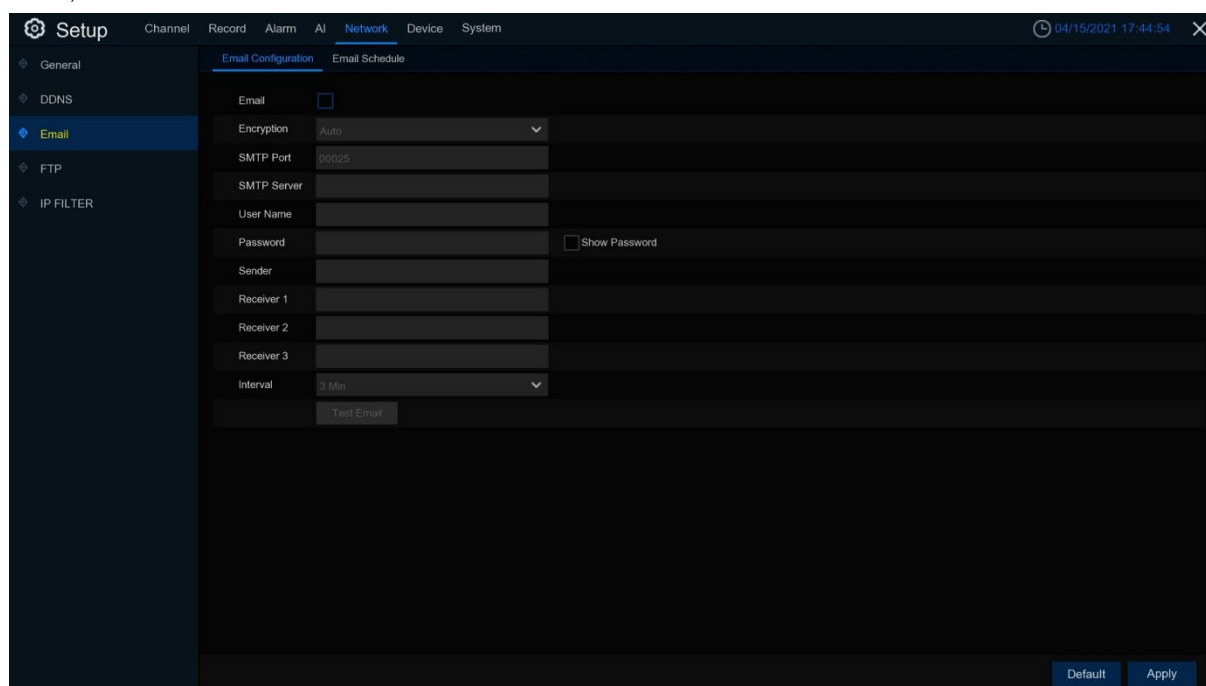

### 5.5.3.1 Email Configuration

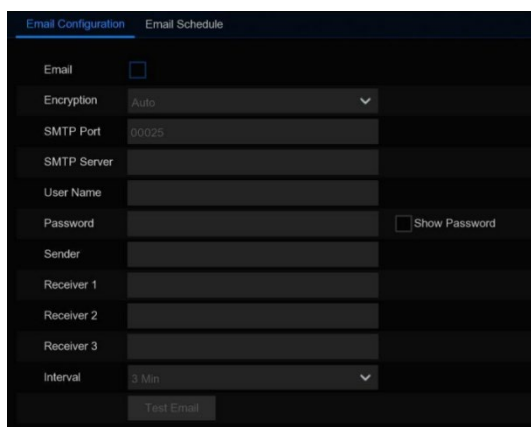

**Email:** Check to enable.

**Encryption:** Enable if your email server requires the SSL or TLS verification. If you are not sure, set to be Auto.

**SMTP Port:** Enter the SMTP port of your email server.

**SMTP Server:** Enter the SMTP server address of your email.

**User Name:** Enter your email address.

**Password:** Enter the password of your email.

**Receiver 1~3:** Enter the email address where you want to receive the event notifications from the DVR.

**Interval:** Configure the length of the time interval between the notification emails from the DVR.

To make sure all settings are correct, click **Test Email**. The system sends an automated email message to your inbox. If you received the test email, it means the configuration parameters are correct.

### 5.5.3.2 Email Schedule

You need to configure the schedule to fully implement the Email notification.

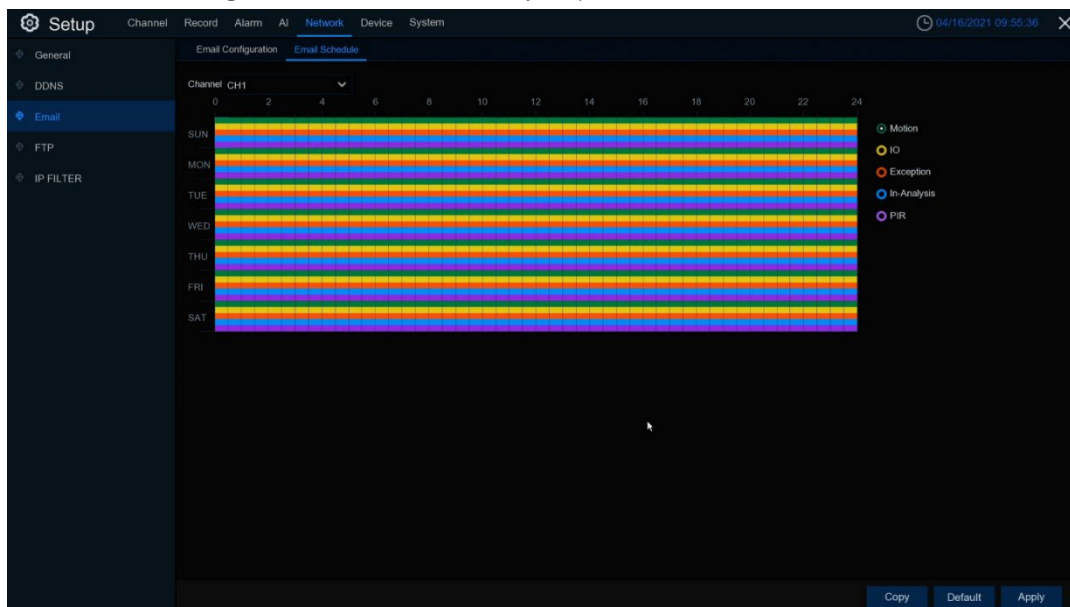

The color codes on email schedule have the following meanings:

- Motion:** Green area
- IO:** Yellow Area
- Exception:** Red area
- In-Analysis:** Blue Area
- PIR:** Purple area

## 5.5.4 IP Filter

This function allows you to set a blacklist and whitelist so that only the IP addresses in the whitelist can connect to the device.

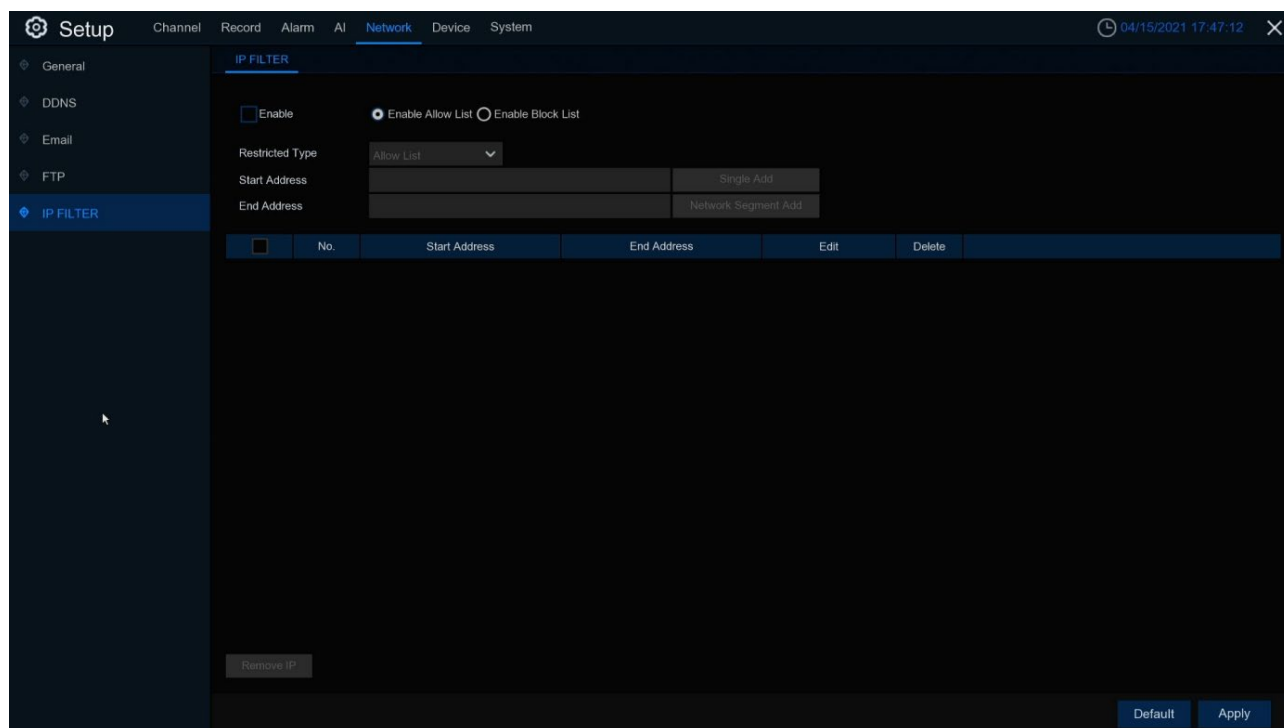

**Enable:** Enable or disable the IP filter function. Can use the blacklist or whitelist once enabled.

**Restricted Type:** Select the list (blacklist or whitelist) to set.

**Start Address:** Input the **Start Address**.

**End Address:** Input the **End Address**.

## 5.5.5 Voice Assistant

The voice assistant function allows DVR to connect Google Cast or Amazon Firetv Stick, and project real-time monitoring images through voice control.

### 5.5.5.1 Amazon

1. Enter your Amazon account and click the **Bind** button to connect and bind your Amazon account.

Choose the video code flow to play to the TV display.

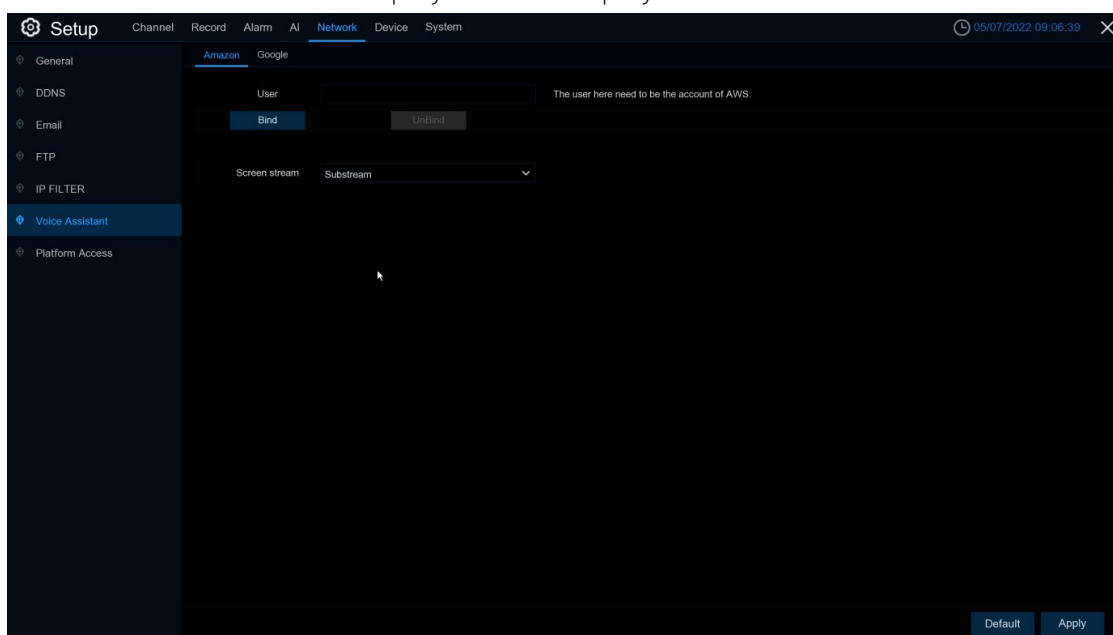

2. Enter “**Channel-Live**” page, set a channel name so that easy to show this channel video on TV or monitoring.

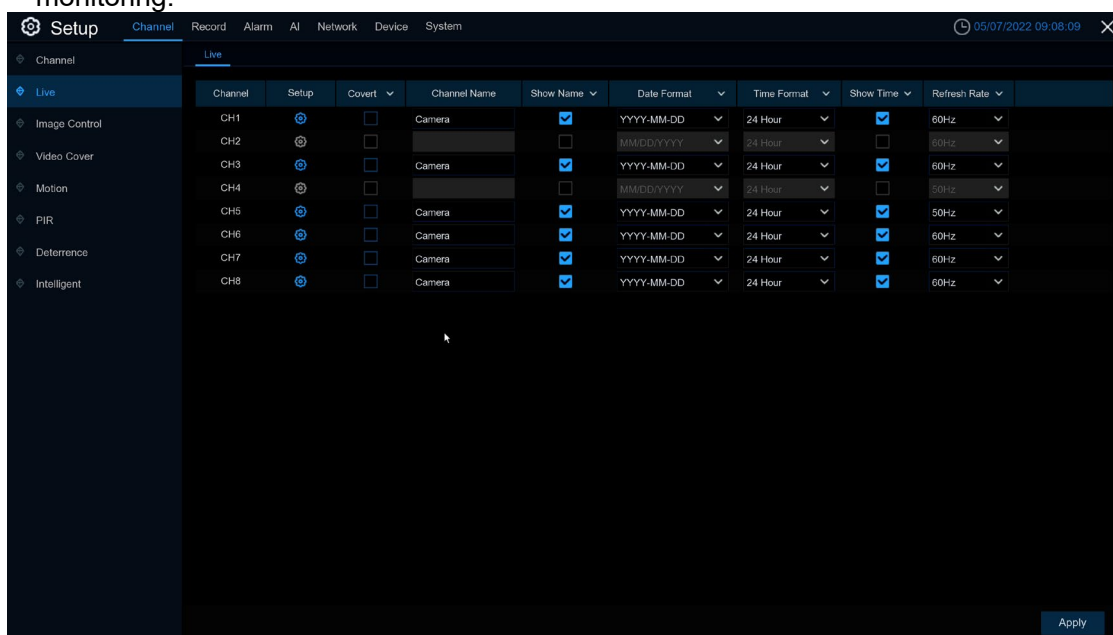



3. Connect Fire TV Stick to the TV monitor and turn on the power. Connect Fire TV Stick to Wi-Fi, which is located in the same local area network as DVR.

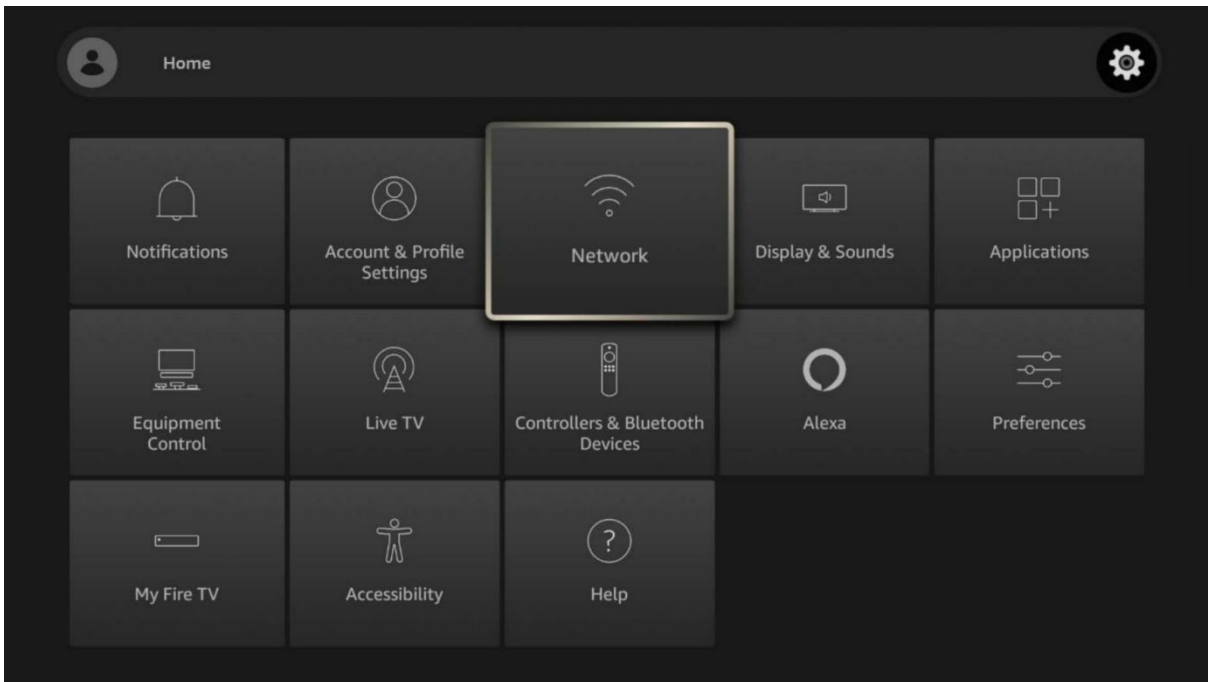

4. Use the existing configuration file or add a new configuration file, and log in to the Amazon account with the same DVR as DVR.

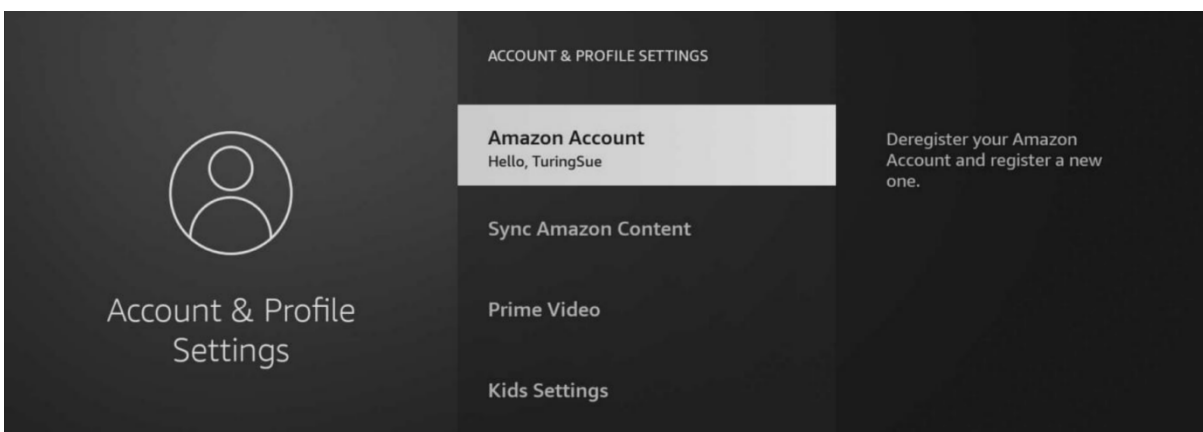
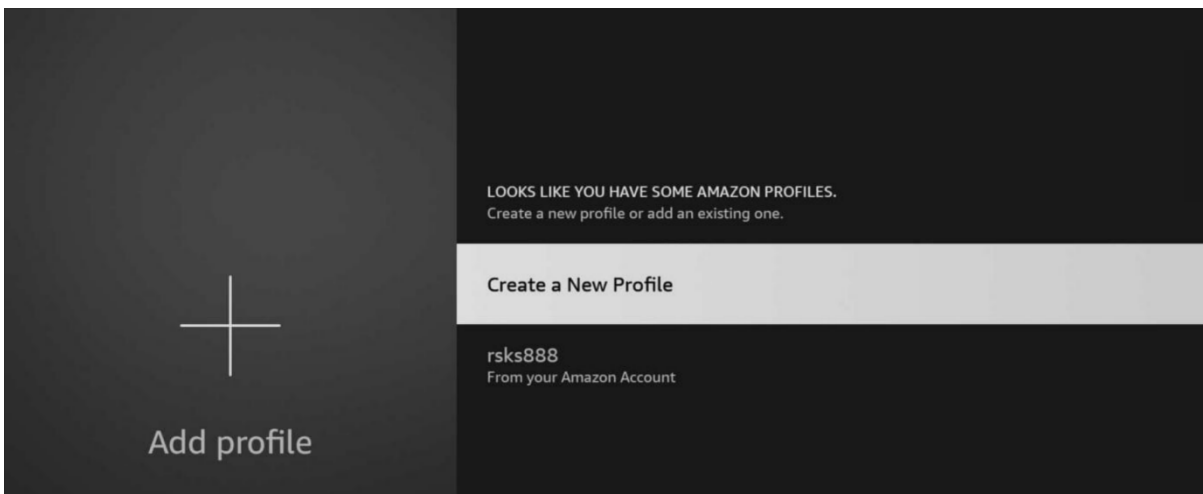

5. Search from the App Store and install Amazon Alexa to your mobile phone, and then log in with the same Amazon account that is bound to the DVR account.

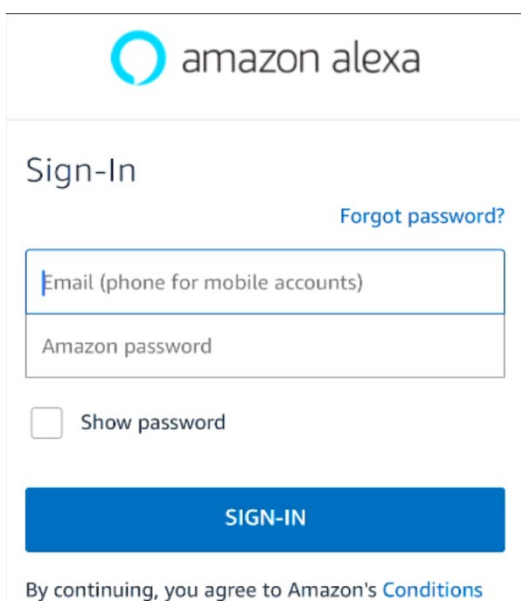

6. Click "More", and then click "Skills and Games".

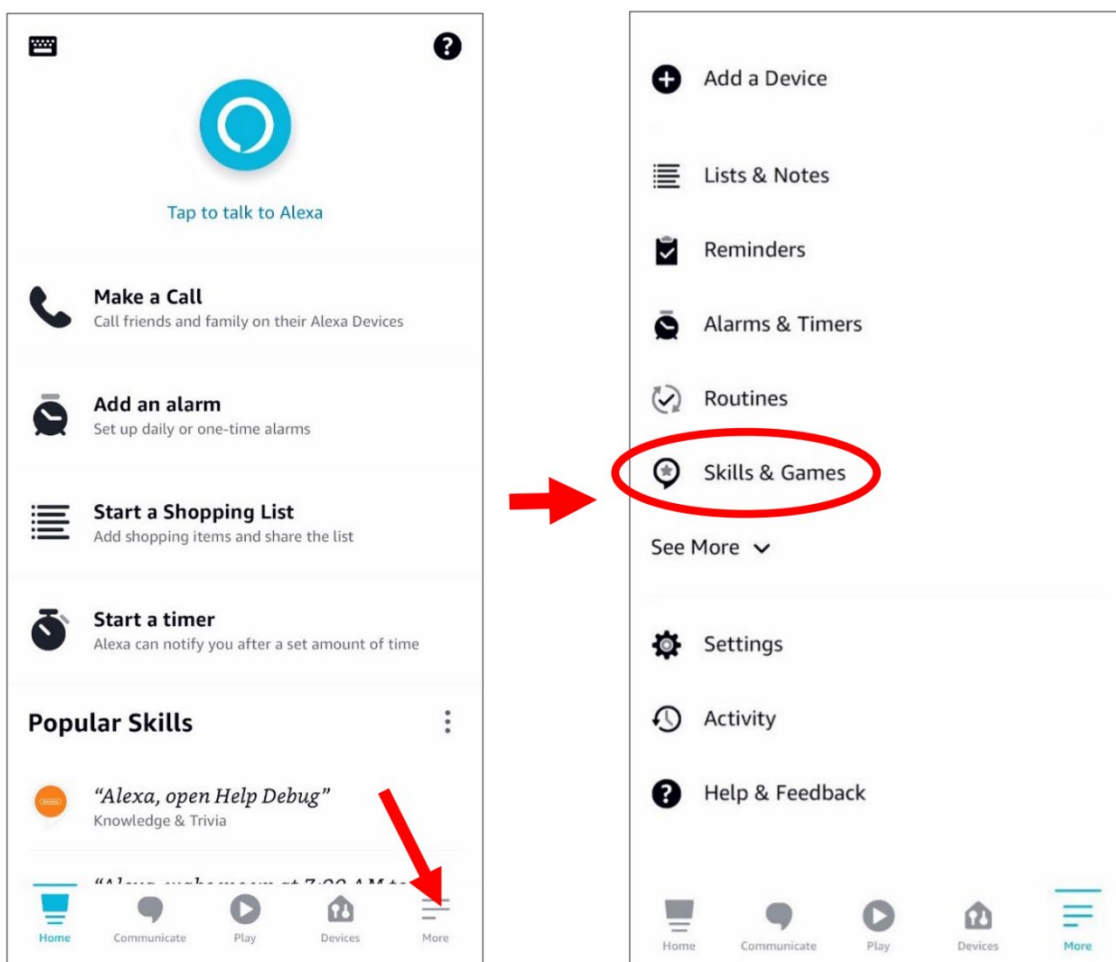

7. Click the search icon in the upper right corner.

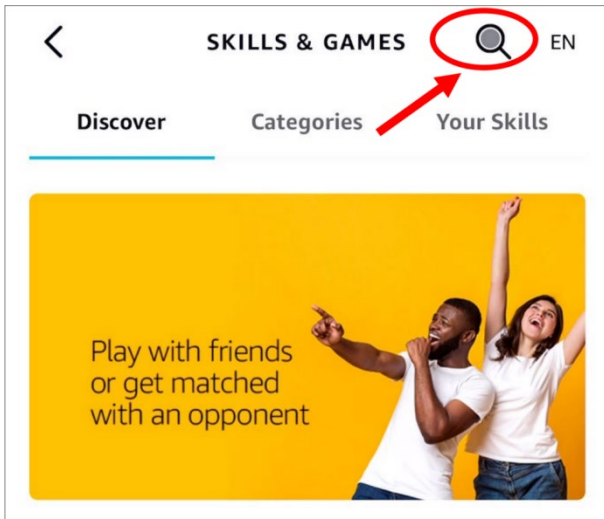

8. Enter keywords: [Smart Camera View](#), and search.

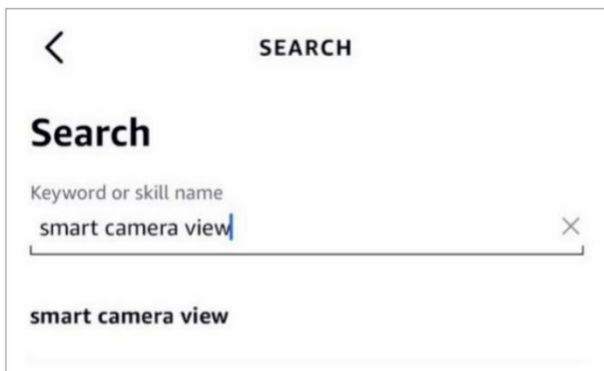

Click "Smart Camera View" to enter search list.

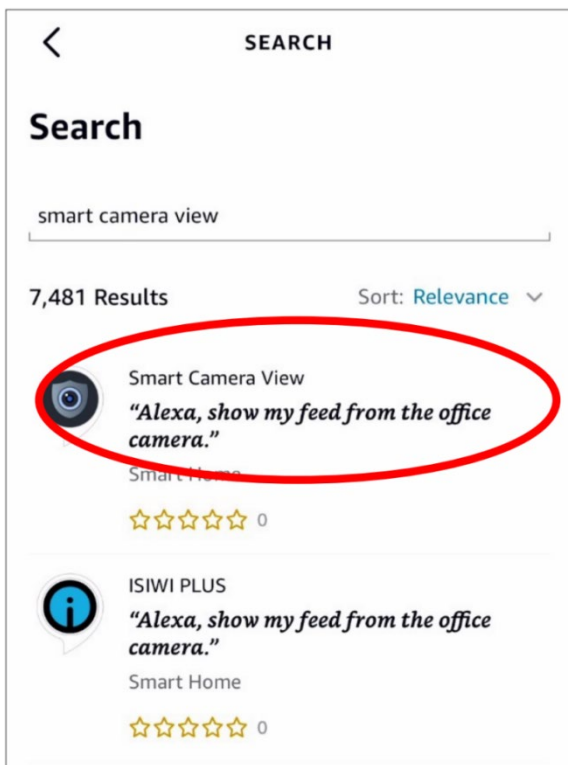

Click "ENABLE TO USE"

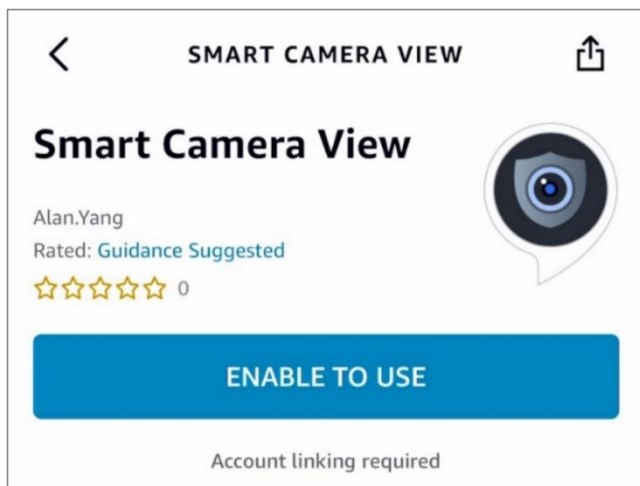

9. You need to link your Amazon account. Log in to the Amazon account with the same DVR as you. After the function is successful, click "Completed".

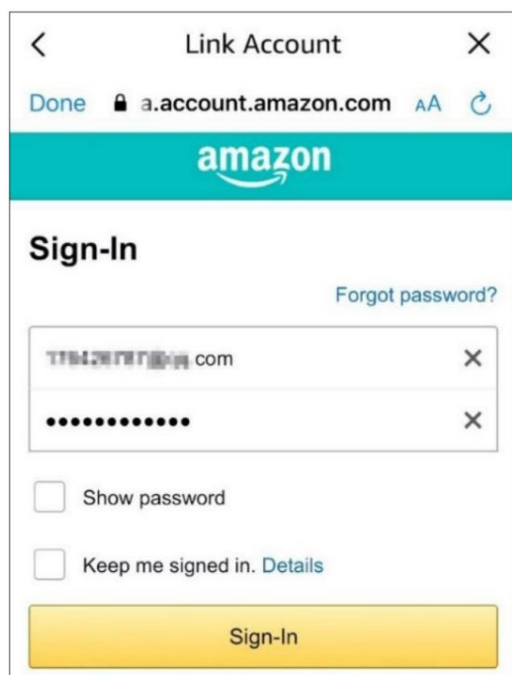

10. Click **“DISCOVER DEVICES”** waiting for the application to search the camera. After finding and connecting the device, click **Next**.

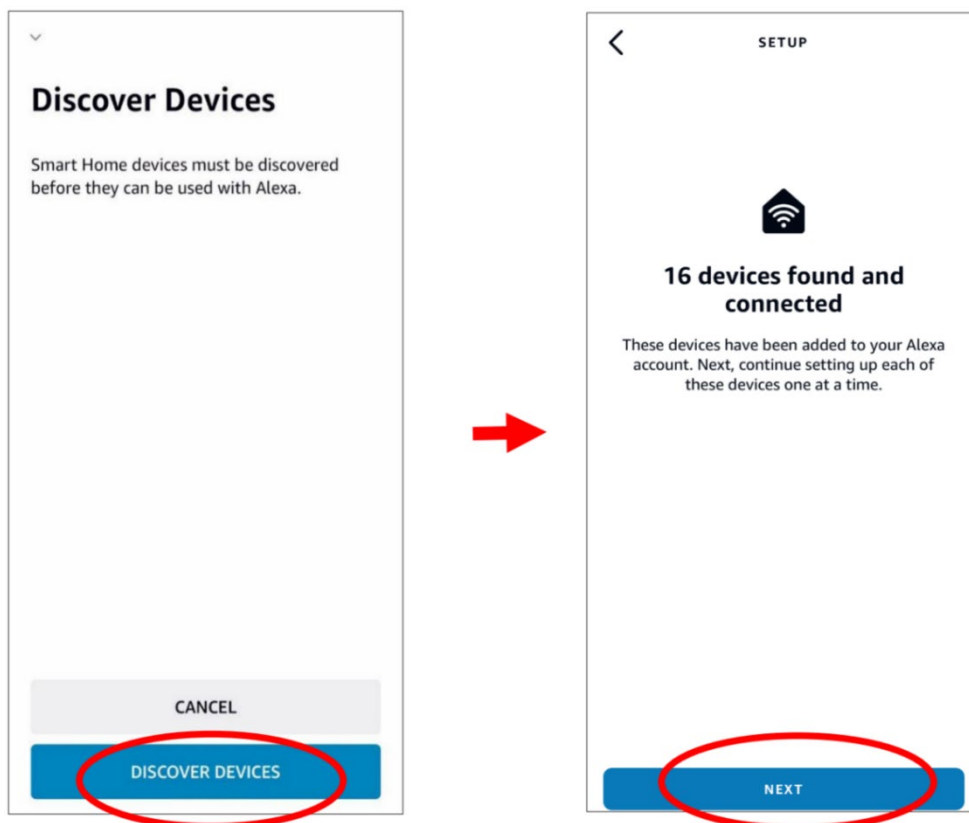

11. Select one of device, then click **SET UP DEVICE**, you can add IP camera to group or pass this step.

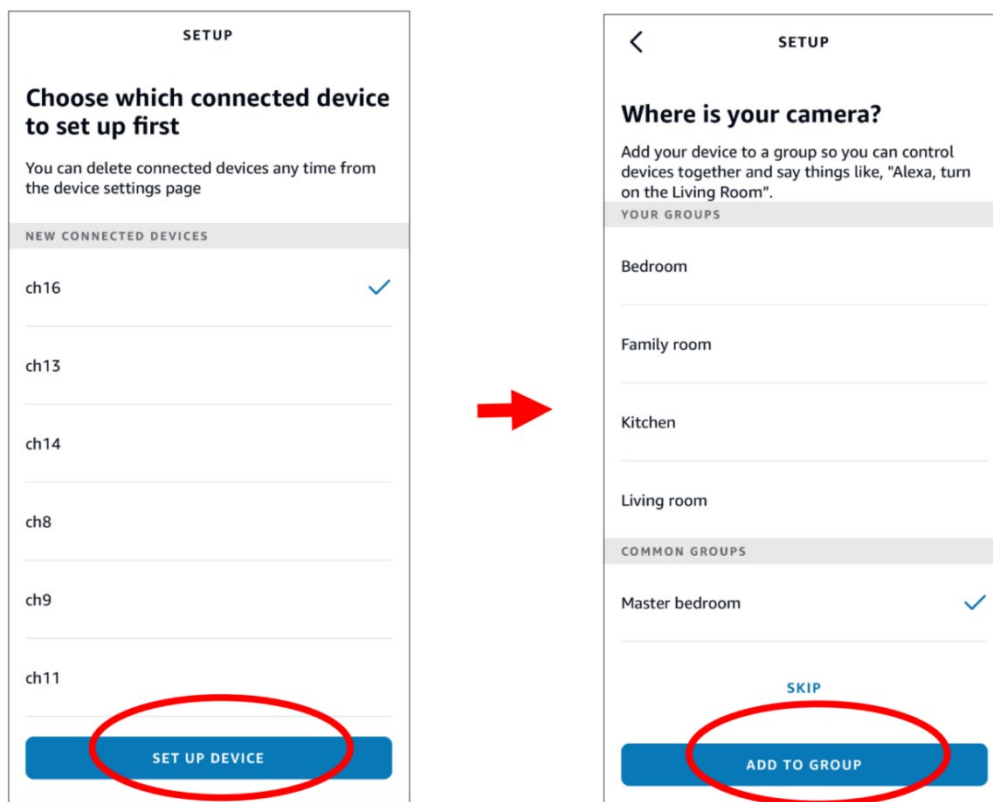

12. Repeat operation 11, add all cameras, then click **Done**.

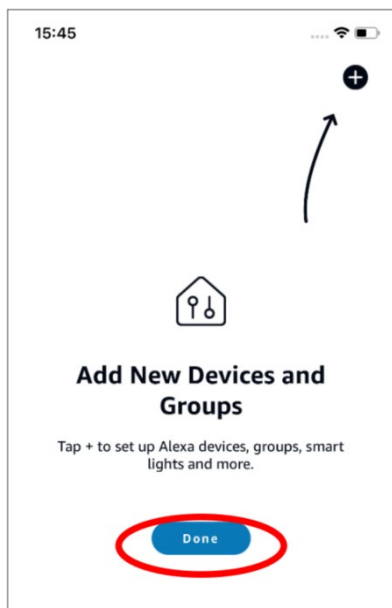

13. All of added camera will display in **Devices** page. Click camera icon to check all cameras.

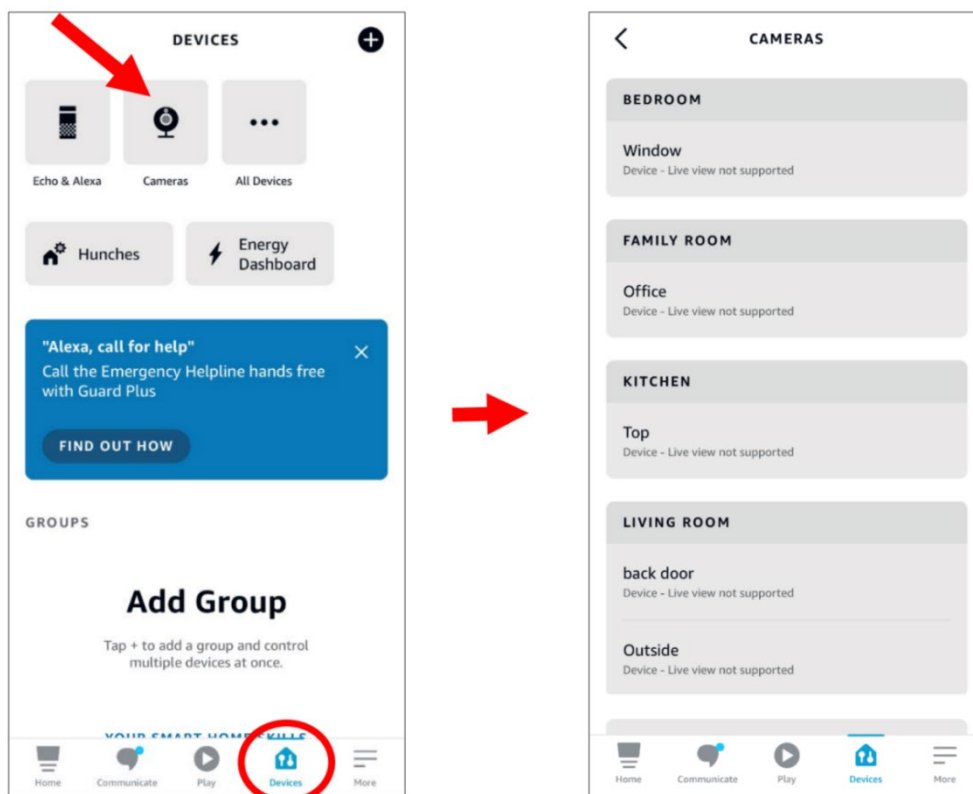

14. Hold on fire TV stick controller audio button, speak out command clearly. The command like this format: Show The XXX camera/Show XXX. XXX is the camera's name. e.g. if channel name is "Office", you can say "Show the Office camera".

15. Waiting for a while, there will be showing the real time streaming on TV monitoring for the office camera.

16. When you want to leave live image, Please say "Stop".

17. If channel are changing, it need to search again and add the camera.

### 5.5.5.2 Google

1. Enter your google account, click **Bind** button to connect and bind your Google account so that you can play the streams on TV monitor.

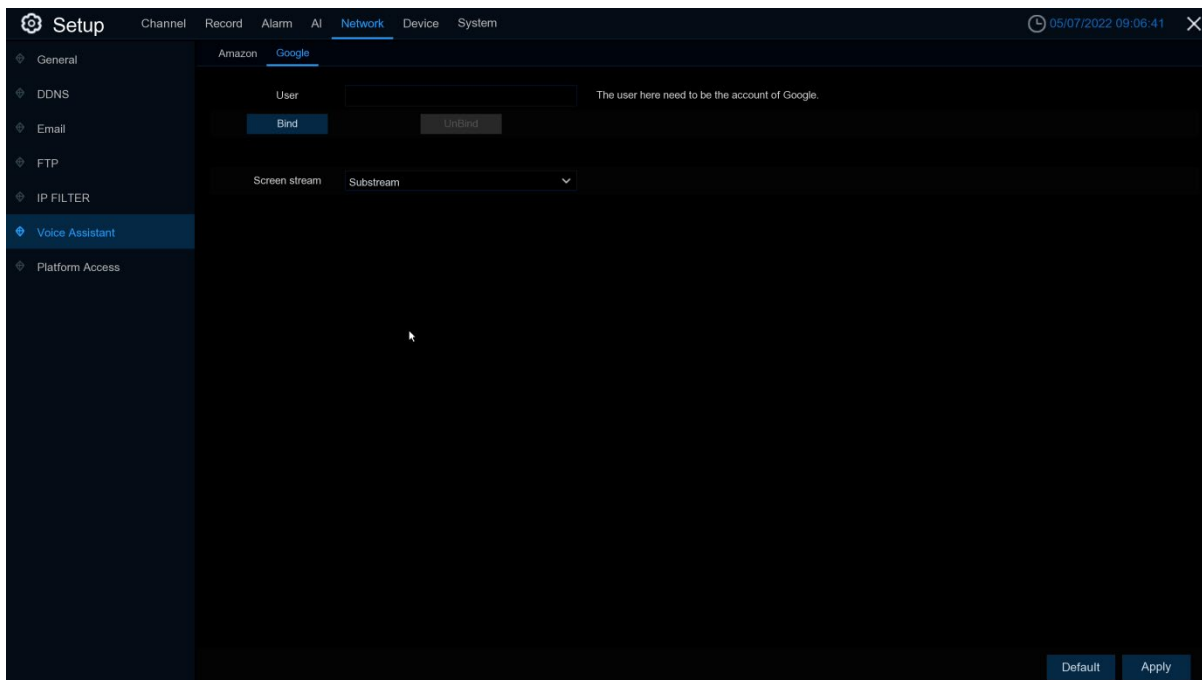

2. Enter "Channel-Live" page, set a channel name so that easy to show this channel video on TV or monitoring.

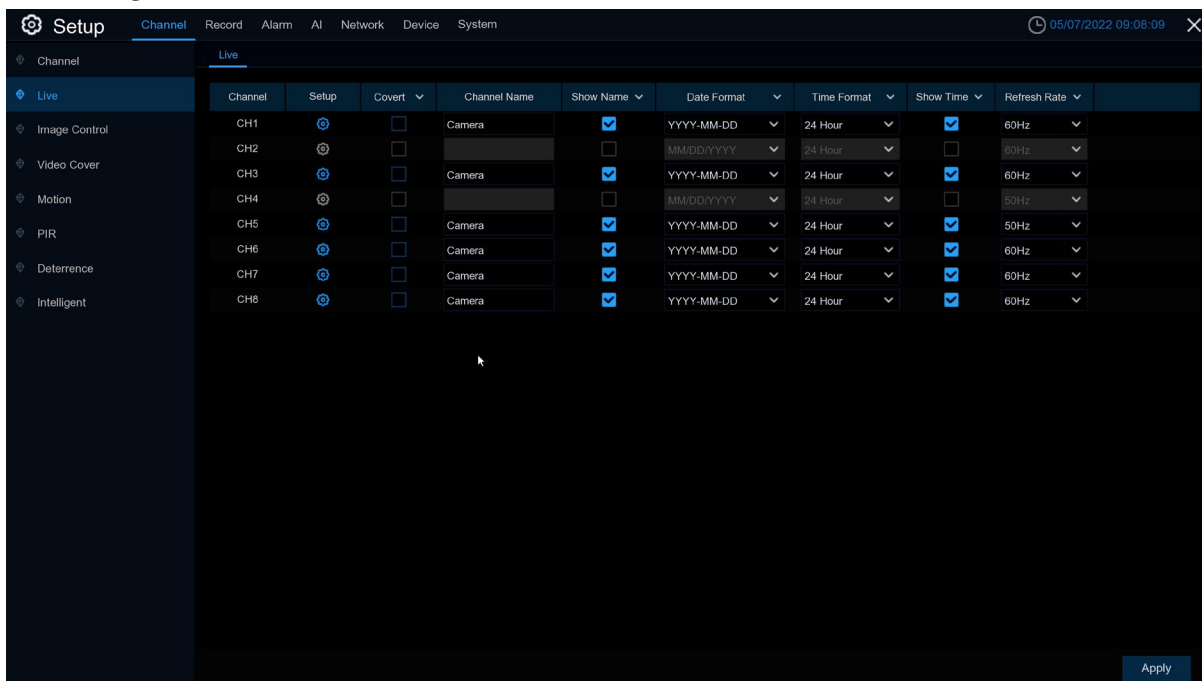

3. Connect ChormeCast to your TV monitor and power on.

4. Search from app store and install Google Home app to mobile phone, click "OK" to allow application using your local network and Bluetooth, then click "OK" .

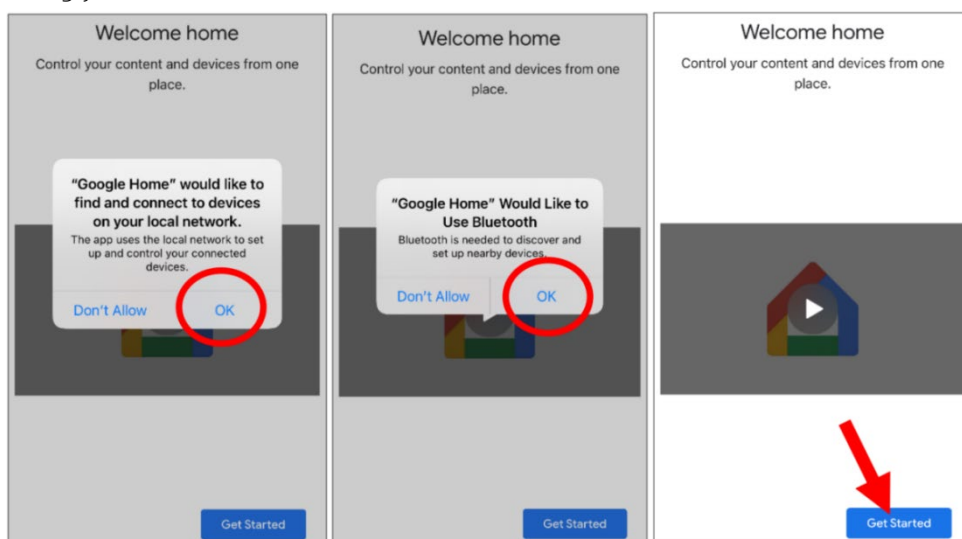

5. Login in your bonded google account .

6. Click "Get Started" create home, then click "New devices" .

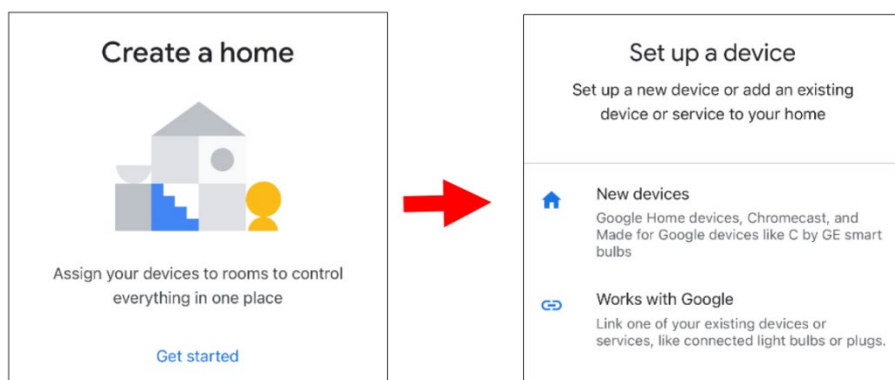

Enter home name and address, then click "Next" .

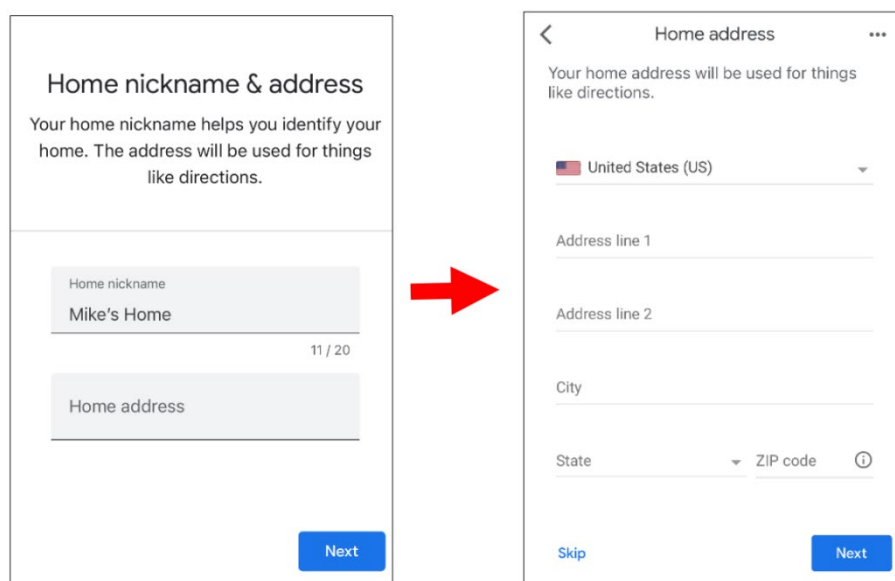



Allow application location access.

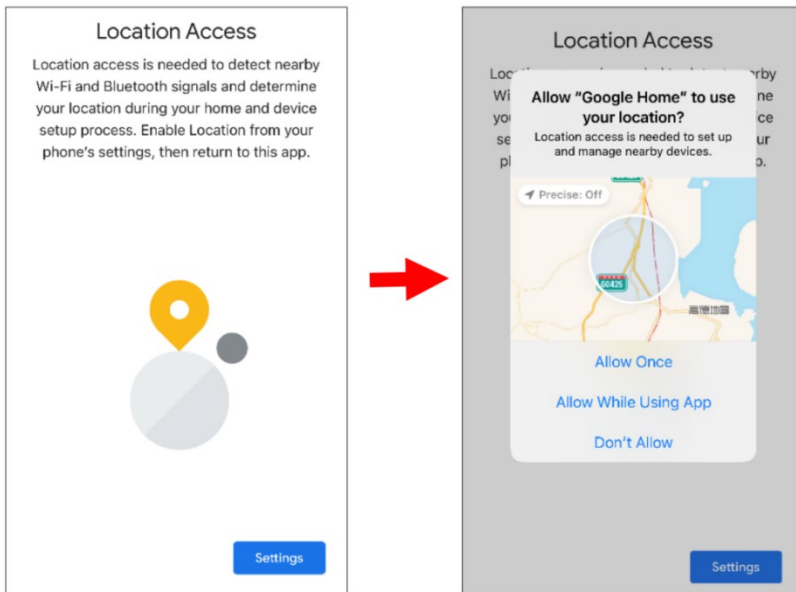

7.The application will try to searching your local network devices automatically, choose Chromecast. Make sure Chromecast is turn on, then continue the next step.

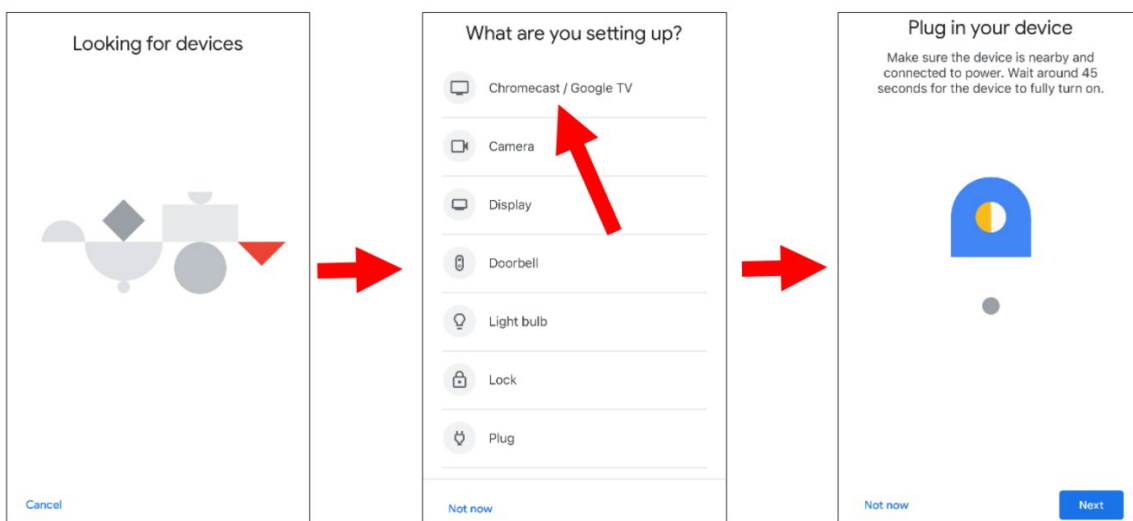

8.Your Chromecast was founded, click Next to connect. Click Yes to confirm the codes.

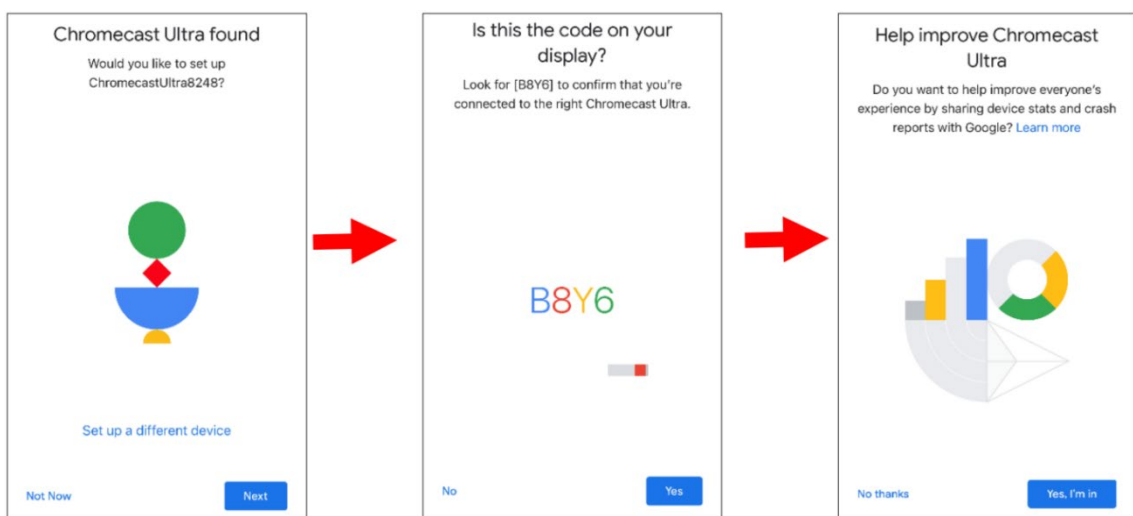

9. Select Chromecast position, then click Next.

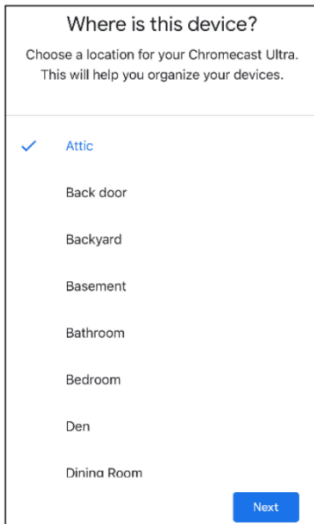

10. Select the Wi-Fi network for Chromecast and enter the Wi-Fi password for connection. Make sure your Wi-Fi is the same as the mobile phone, and is located in the same local network as DVR. Click Continue to the next step.

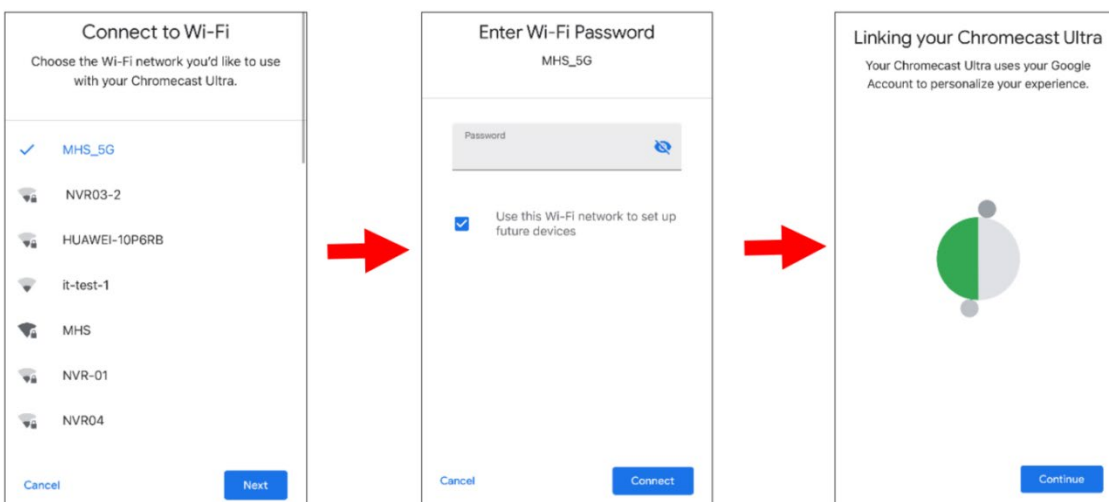

11. Click NO THANKS or Sign Up to log in to your Google account.

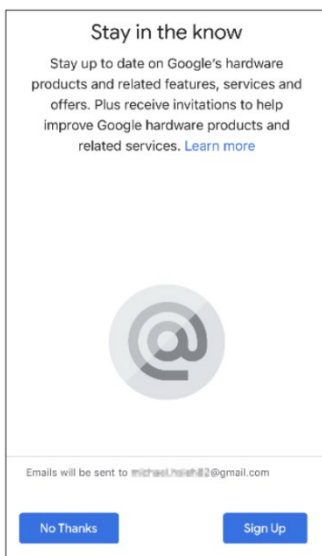

Click Next->Skip->Finish Tutorial

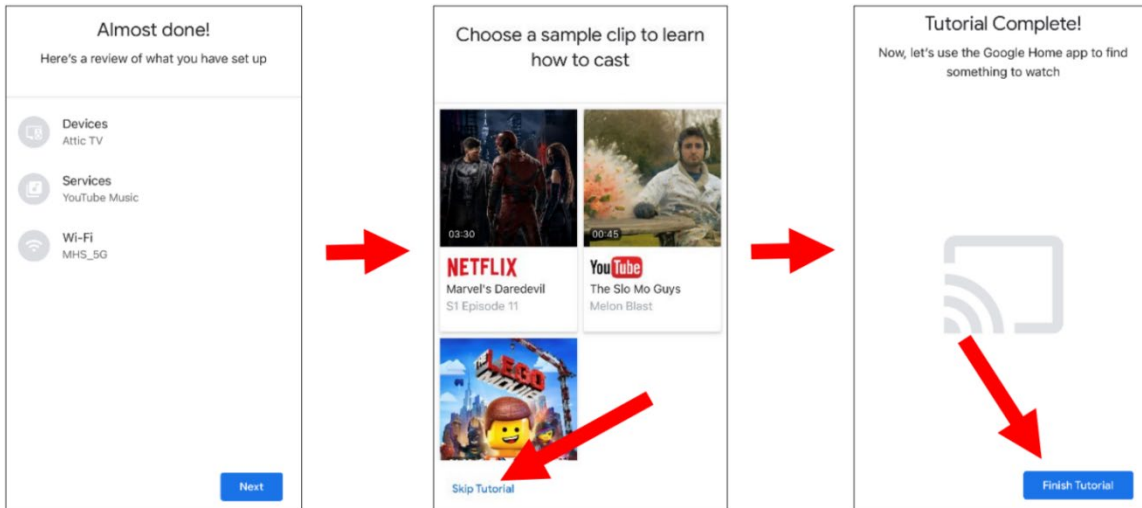

12. Now Chromecast is added to your google home page, click left upper + icon to set up device.

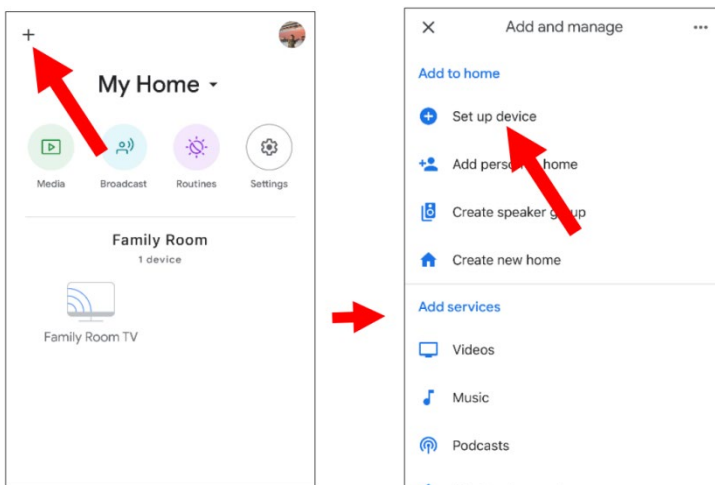

Select "Works with Google", click right upper search icon, then enter "smart camera view".

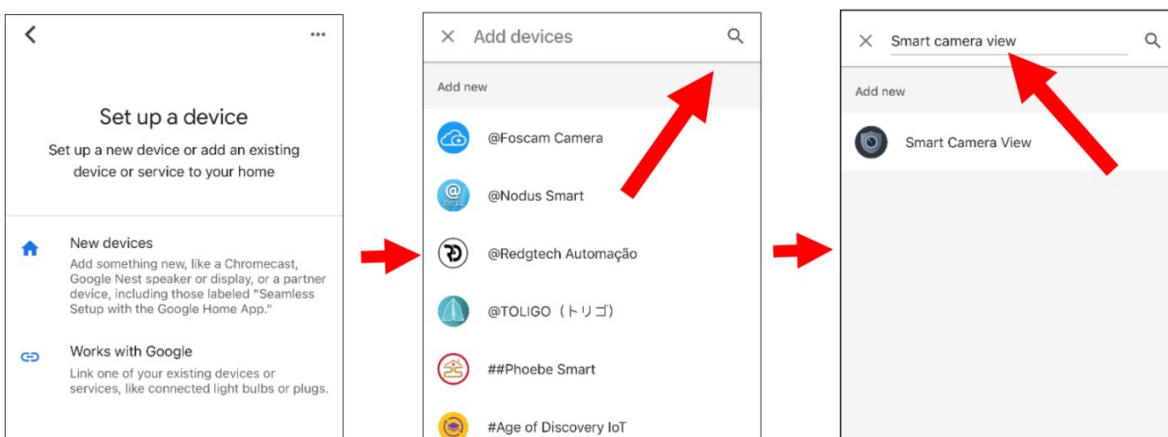

On search result Click “[smart camera view](#)” .Need to log in your google account and allow google visit your devices.

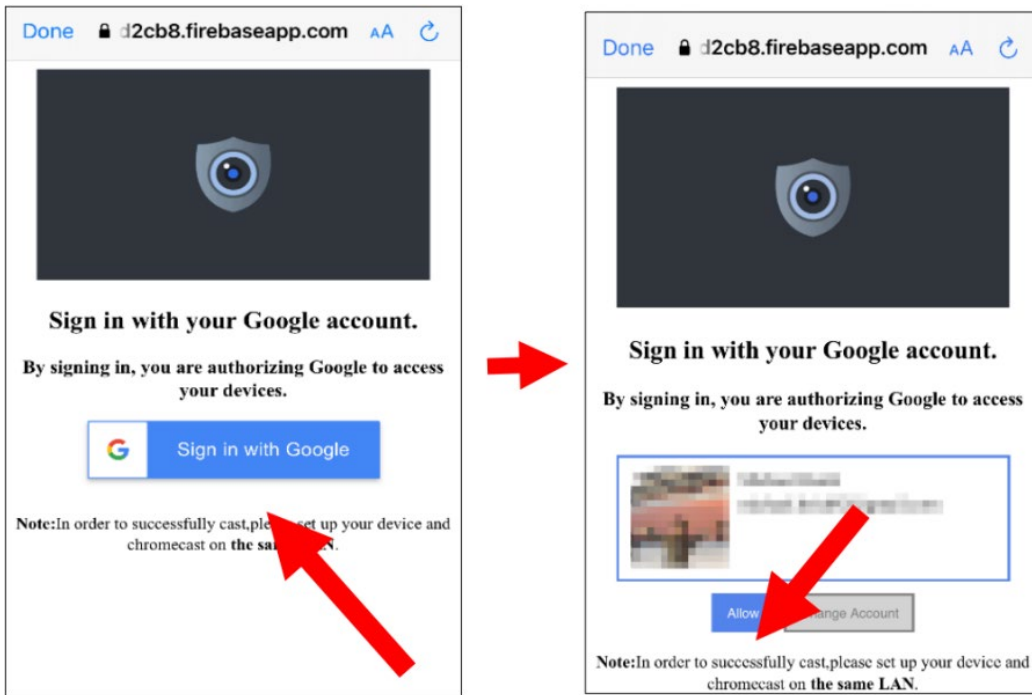

Waiting for a minute, the application will connect to Google home.

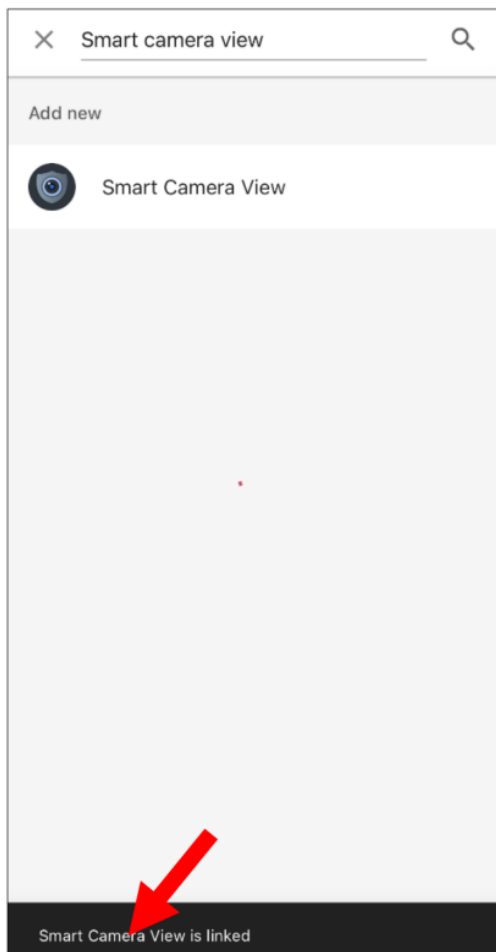

13. The camera available in DVR will now be displayed. Select one of the cameras and touch the next button. Select a home and location for the camera step by step

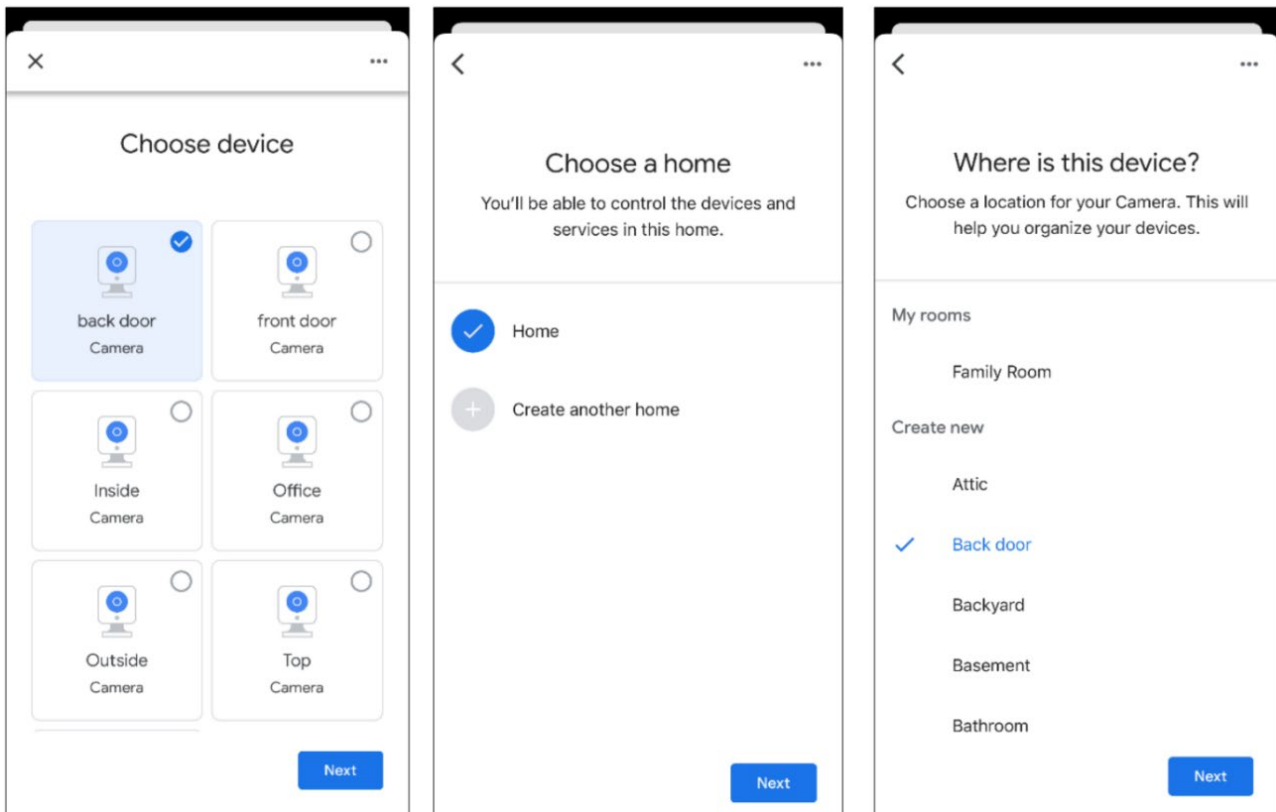

14. Repeat the operation of the 13th, add all the camera.

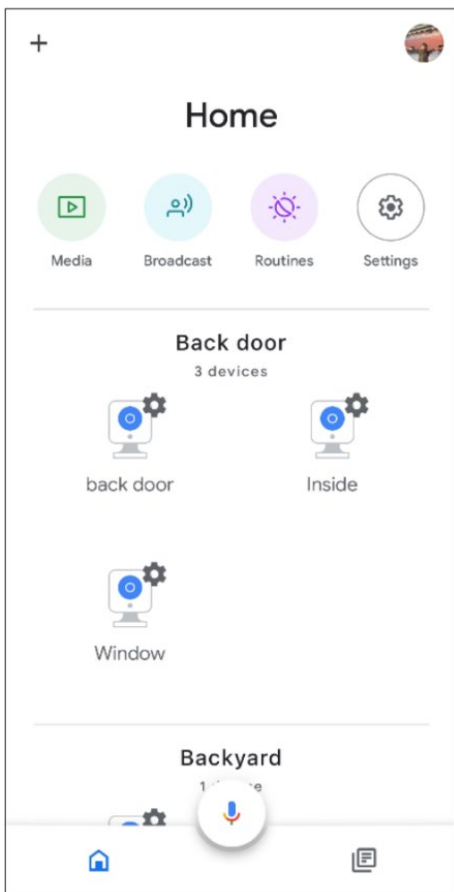

15. Search from the App Store and install the Google Assistant application to the mobile phone.

16. Run Google Assistant, log in to your Google account, this account is bound to the same account that is bound to DVR.

17. Now, you can use the text or voice command to transmit the camera to TV monitor, such as "show/play the \*\*\* camera on XXX TV". Among them, \*\*\* is the name of the camera, xxx is your TV name.

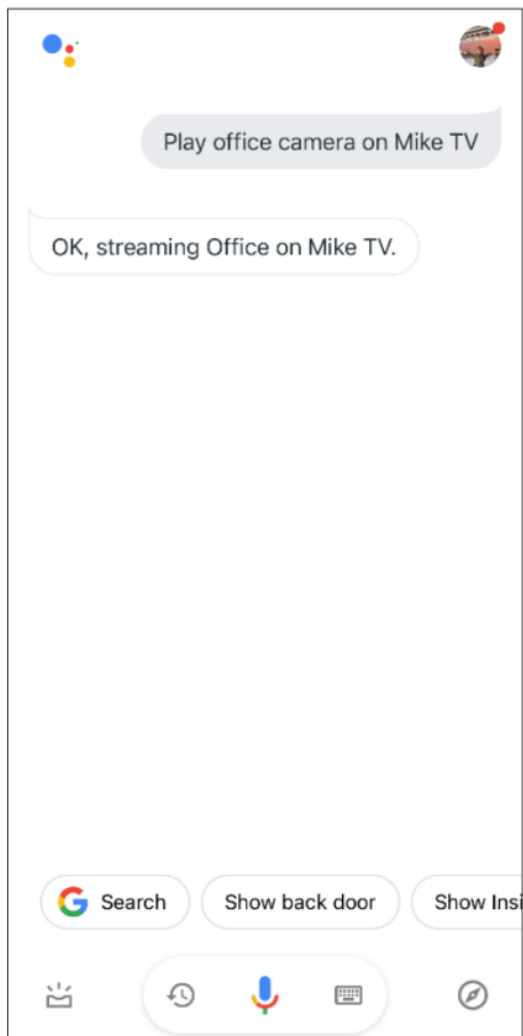

## 5.5.6 Platform Access

### 5.5.6.1 Onvif

Enable this function allow devices to be searched and add by other third-party platforms through the ONVIF protocol.

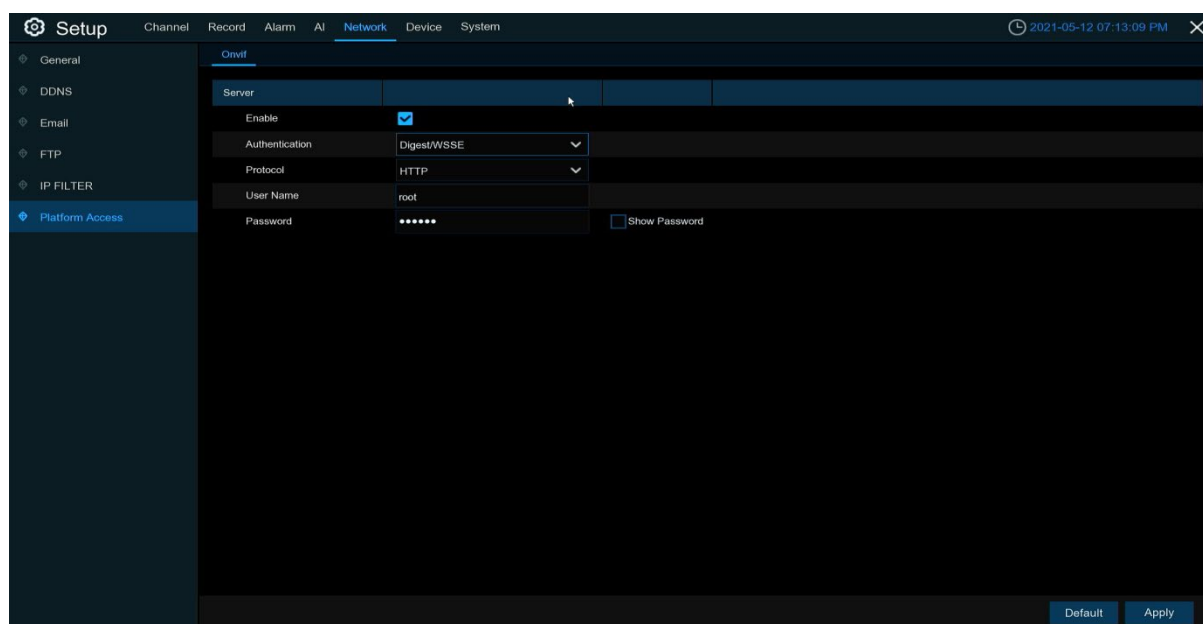

**Enable:** Enable switch. If turn off this menu, the service will be failed.

**Authentication:** Login authentication mode, authentication methods including Digest\_sha256, Digest, Digest/WSSE, WSSE.

**Protocol:** Connection protocol

**Username:** login user name

**Password:** login user password

**Note:** The stream connected by the back end through the ONVIF protocol are all the pictures of the first channel.

### 5.5.6.2 RTMP

Through the RTMP protocol, you can push the NVR's audio and video streams to video sharing websites for live broadcasting, such as YouTube.

Using YouTube as an example, to use this function, you need to:

- Register a YouTube account and create a live streaming studio.
- Set the URL and live code of the live streaming studio.
- Set the live server address on the NVR.
- Enable and configure the code stream type and live broadcasting channels.
- Save the configuration and refresh the YouTube live room page to start watching the live broadcast

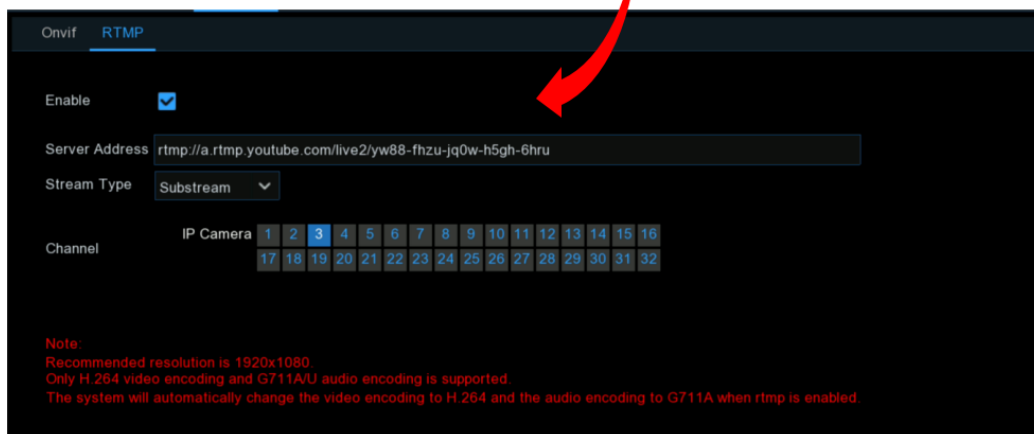
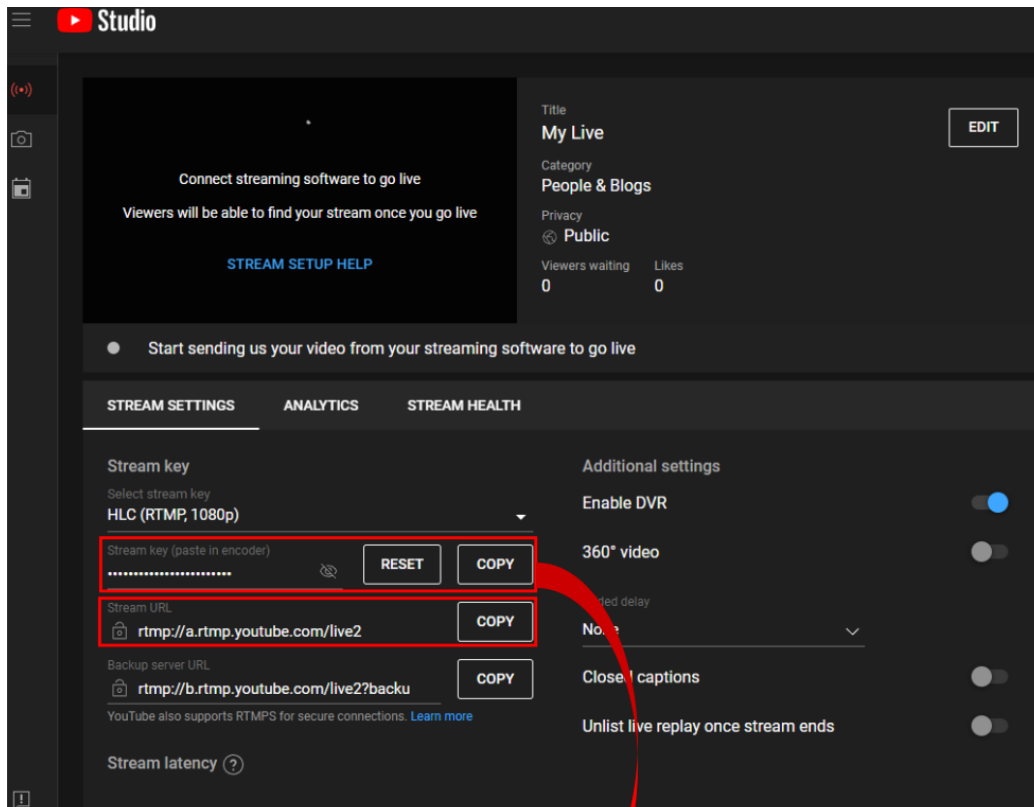

**Enable:** Enable or disable the RTMP live broadcasting function.

**Server Address:** Enter the live broadcasting address and live code of the YouTube server. (Note: Use a "/" between the live broadcasting address and the live code.)

**Stream Type:** Select the stream type for the live broadcasting channel. Both the main stream and substreams are supported.

**Channel:** Select the channel for live broadcasting. Only one channel can be selected.



Note:

- To ensure optimal live broadcasting quality, it is recommended that the resolution of the stream does not exceed 1920 × 1080.
- Live broadcasting is supported only for data streams using the H.264 video encoding format and G711A/U audio encoding format
- YouTube live code can be assigned to only one device and cannot be reused.

### 5.5.6.3 Event Push Platform

This function is used to push alarm information from the device to a specified third-party platform. Ensure that the third-party platform has completed the necessary integration and testing with the device. Event push can be done via HTTP or UDP methods.

Event push is divided into HTTP push and UDP push: HTTP has POST and GET methods. UDP has unicast, multicast and broadcast methods.

- HTTP Push

**Enable:** Enable or disable the event push function.

**Name:** Set the device name for sending alarm information to the third-party platform.

**Push Method:** Check HTTP for HTTP push method.

**User Name:** User name of the third-party platform

**Password:** Password of the third-party platform

**Server Address:** Address of the third-party platform

**Port:** Port of the third-party platform server (range 1-65535)

**URL:** API endpoint of the third-party platform server

**Method:** Type of HTTP push. Supports POST and GET methods. Only HTTP-POST supports image push, while others only send messages without images. The alarm types for image push are consistent with those in the web preview alarm bar.

**Interval:** Keep-alive interval. The device will send messages to the server at the set interval. UDP does not have a keep-alive mechanism.

- UDP Push

**Enable:** Enable or disable the event push function.

**Name:** Set the device name for sending alarm information to the third-party platform.

**Push Method:** Check UDP for UDP push method.

**UDP Method:** Supports three methods: Unicast, Multicast, and Broadcast:

- **Unicast:** Enter the client UDP server's IP address and port to receive push messages. Only this address will receive the messages.
- **Multicast:** Multiple client UDP servers on the same subnet using the same UDP address and port can receive the messages. Others outside this UDP address will not.
- **Broadcast:** All UDP servers on the same subnet can receive the messages

**UDP Address:** Address of the UDP server.

**UDP Port:** Port of the UDP server (range 1-65535).

## 5.6 Storage

In this section, you can configure the internal HDD & Cloud storage function.

### 5.6.1 Hard Disk

This menu allows you to check & configure the internal HDD(s). You need to format the HDD only at the first startup and if you replace a new HDD.

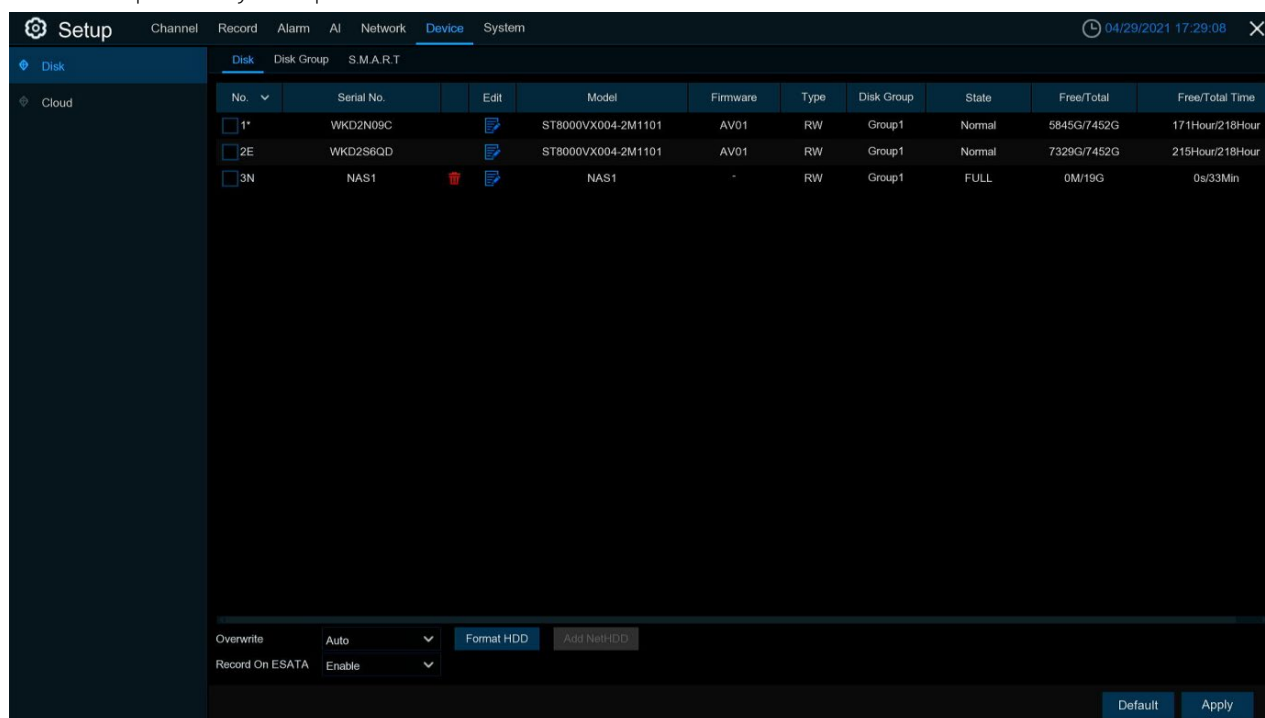

**Format HDD:** Select the HDD you want to format and then click **Format HDD**. To start formatting, you need to enter your user name and password and then click **OK** to confirm to continue formatting.

**ADD NetHDD:** this function to add a network hard disk. After configured the network hard disk (NAS), you can connect NAS to record channel video or grab maps through the network connection. But AI Face Database can only be stored in the hard disk.

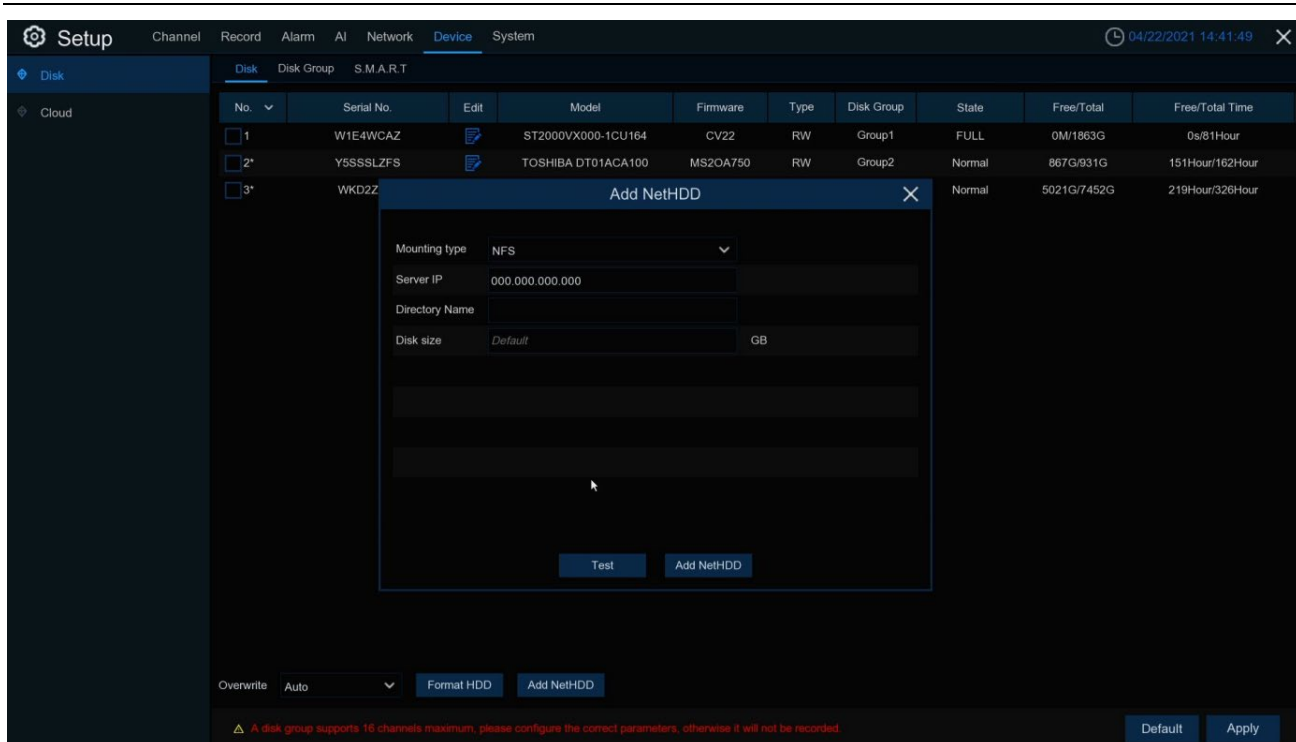

**Mounting type:** NFS and CIFS types, NFS needn't to enter NAS account and password, CIFS need to enter NAS account and password.

**User Name:** NAS account (NFS this option is invisible) .

**Password:** NAS password (NFS this option is invisible) .

**Server IP:** NAS IP address.

**Directory Name:** Enter the folder that wants to store data in NAS

**Disk Size:** Set up network disk size

**Test:** Test whether NAS connected.

**Add NetHDD:** Click to add NAS.

**Overwrite:** Use this option to overwrite the old recordings on the HDD when the HDD is full. For example, if you choose the option 7 days then only the last 7 days recordings are kept on the HDD. To prevent overwriting any old recordings, select **OFF**. If you have disabled this function, please check the HDD status regularly, to make sure the HDD is not full. Recording will be stopped if HDD is full.

**Record on ESATA:** This menu only displayed when your DVR is coming with an e-SATA port on the rear panel. It will allow to record the video to external e-SATA HDD to enhance your HDD capacity. If the e-SATA recording function is enabled, e-SATA backup function will be disabled.

If your DVR supports to install multiple HDDs, the edit icon  appears in your system, you can Click it to edit the HDD as below:

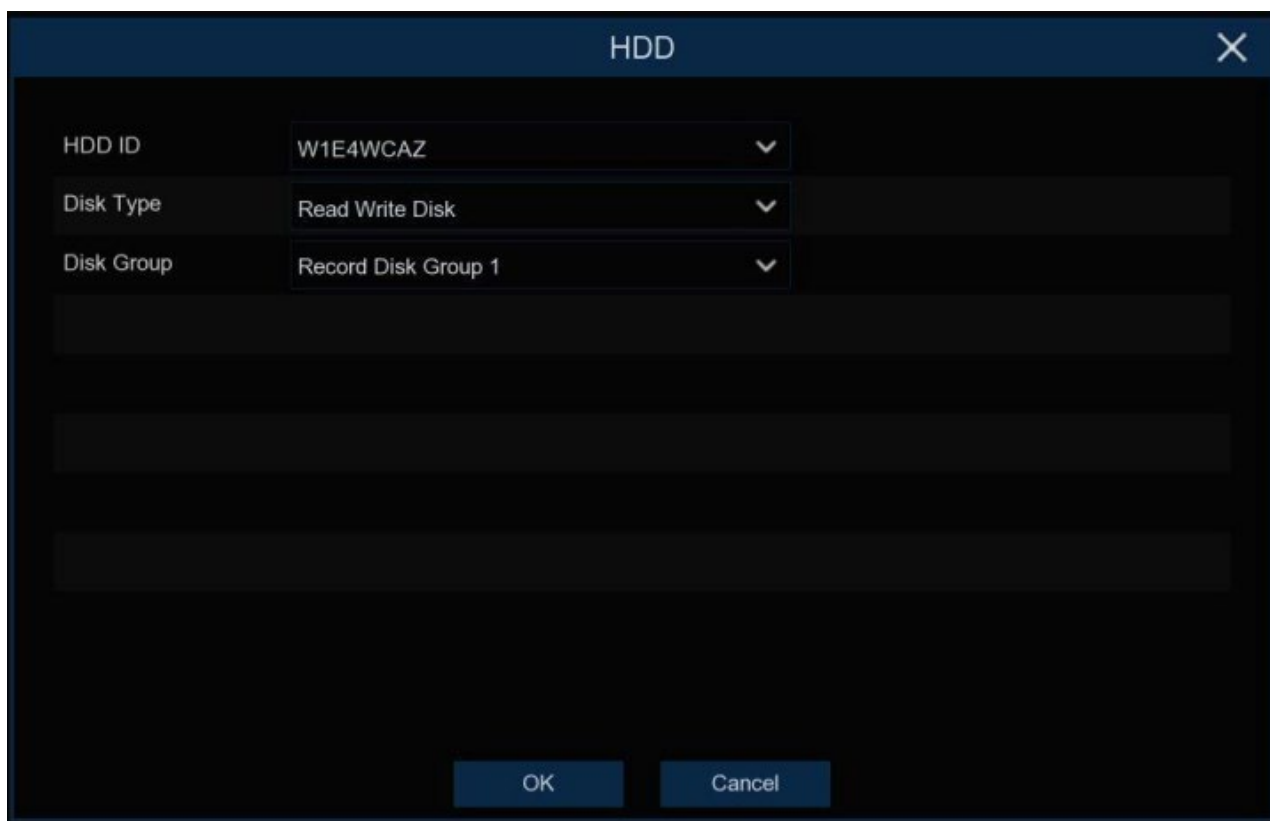

**Disk Type:** Read-write, read-only, and redundant.

Read-write mode is the normal status for a HDD to save recording or search recording to play.

To prevent important video data from being overwritten during cyclic recording, the HDD can be set as **Read-only** mode. New recording will be not able to save into this read-only HDD. You can still search recording from this read-only HDD to play.

A **Redundant** HDD can be used to automatically backup video footage on the recording (read-write) hard drive. When a redundant HDD is set, the system can be set to record cameras in parallel to both the recording hard drive and the redundant hard drive in case of hard drive failure.

Only some devices support NAS (Network Hard Drive). NAS is a dedicated data storage server. You can add a hard disk on a remote server to completely separate the storage device from the server, facilitating centralized data management. The figure below only shows the NAS function, and does not represent all the functions of the DVR.

### 5.6.1.1 Disk Group

If your DVR supports to install multiple HDDs, you can configure the HDD to be different groups. HDD groups allow you to balance recordings across multiple hard drives. For example, you can record channels 1~4 to one hard drive and 5~8 to a second hard drive. This can reduce the amount of wear on the hard drives and may extend the life of the hard drives.

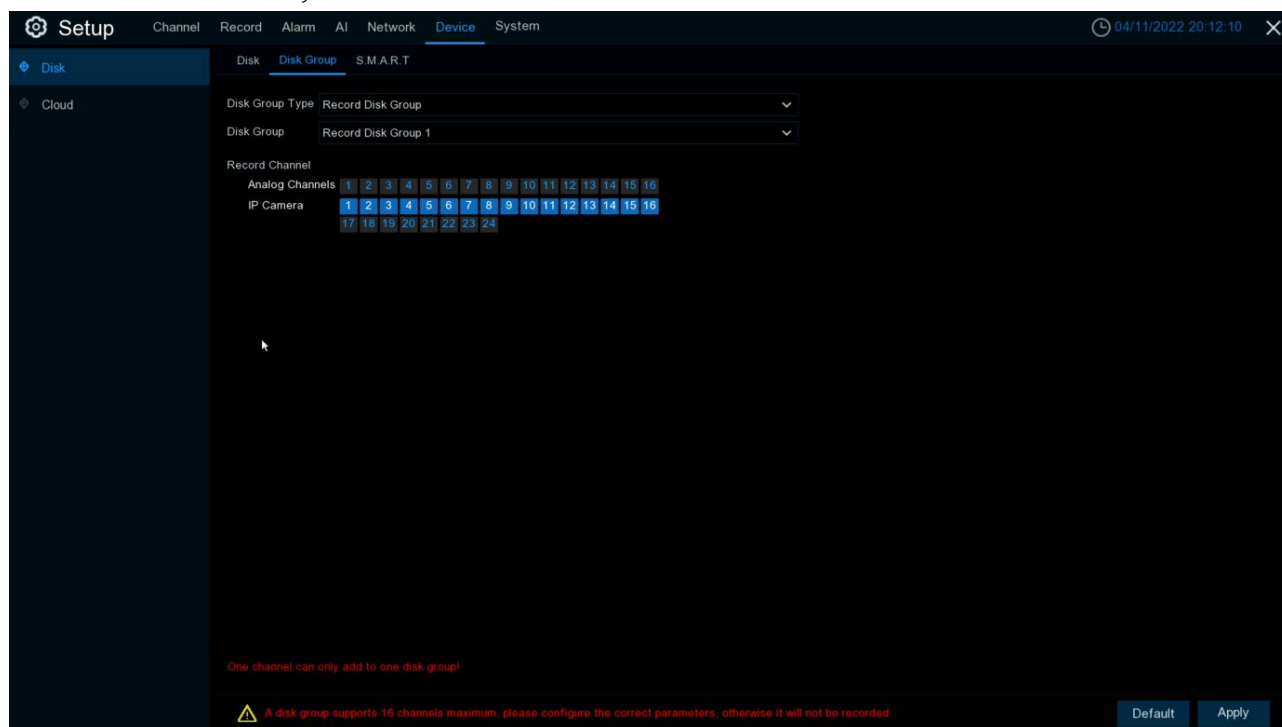

1. Use **Disk Group Type** to select the type of group to configure.
2. Use **Disk Group** to select the specific group within the selected group type.
3. Click the numbered boxes representing channels to record channels to HDDs in the selected group.
4. Click **Apply** to save.

### 5.6.1.2 S.M.A.R.T

This function can be used to display technical information on the hard drive installed inside your DVR. You can also perform a test (there are three types available) to evaluate and detect potential drive errors.

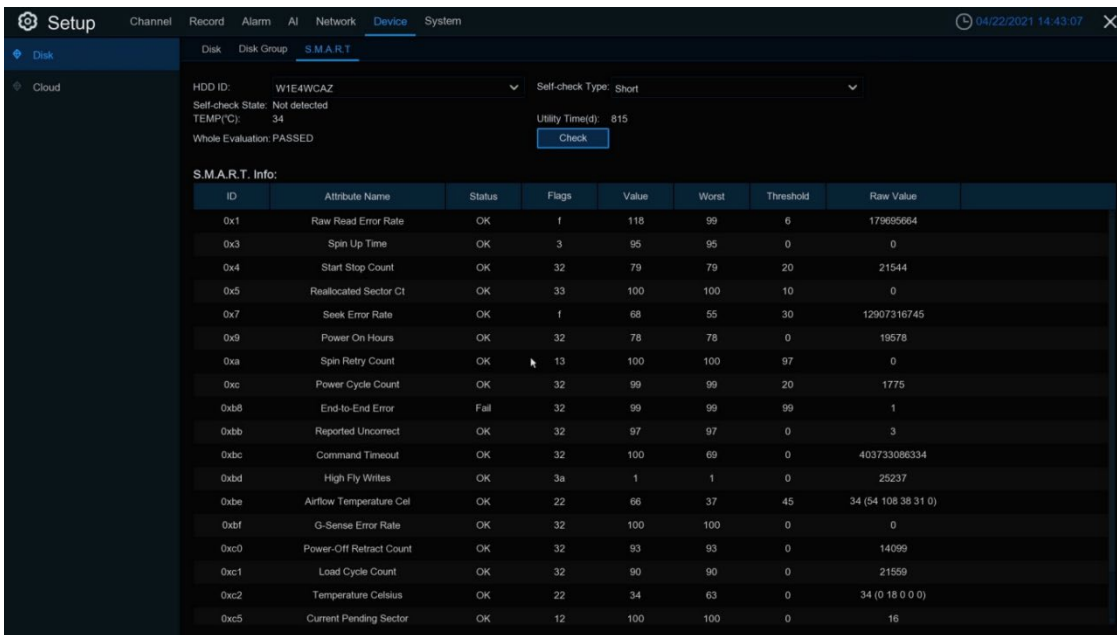

**Self-check Type:** There are three types available:

**Short:** This test verifies major components of the hard drive such as read/write heads, electronics and internal memory.

**Long:** This is a longer test that verifies the above as well as performing a surface scan to reveal problematic areas (if any) and forces bad sector relocation

**Conveyance:** This is a very quick test that verifies the mechanical parts of the hard drive are working.

**Note:** When performing the test, your DVR will continue to work normally. If you find a hard disk S.M.A.R.T. error, you can continue to use the hard disk, but there is a risk of losing recorded data. It is recommended to replace the hard disk with a new one.

Your NVR can upload snapshots and video recordings to cloud storage via Dropbox™ or Google Drive™, allowing you to store and access these files remotely whenever needed.

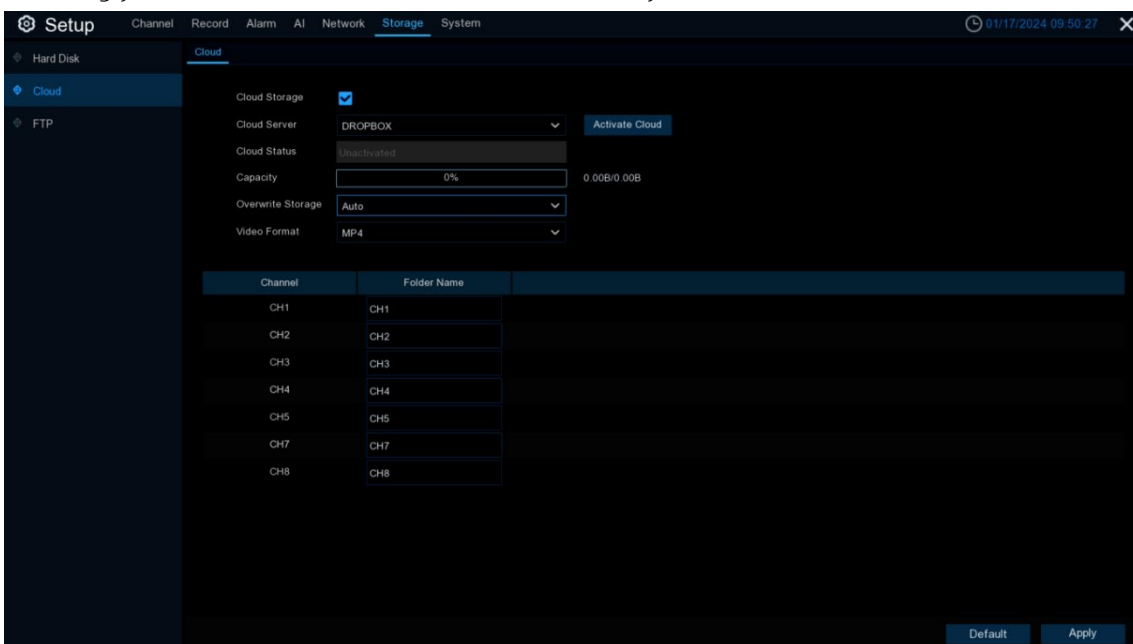

**Cloud Type:** Select whether to use Dropbox or Google Drive.

**Cloud Status:** This will indicate "Activated" when cloud storage is active.

**Capacity:** When activated, this will show how much free space remains in your cloud storage.

**Cloud Overwrite:** This instructs your NVR to overwrite the oldest video files when cloud storage becomes full. You can also specify the number of days for recordings to be retained before being overwritten. For example, if you choose 7 days, only the last 7 days of recordings are kept in cloud storage.

To prevent any old recordings from being overwritten, select OFF. If you disable overwriting, please check the storage status regularly to ensure space does not become full, as uploads will stop when storage is full. We recommend leaving Auto selected to prevent running out of cloud storage space.

**Video Type:** Choose the video format you want to upload.

**Folder Name:** Create a separate folder for each camera to store its uploaded files.

## 5.6.2 Cloud

### 5.6.2.1 Dropbox Settings

1. Before activation, we recommend creating a Dropbox account first at [www.dropbox.com](http://www.dropbox.com) if you don't have one already.
2. Choose "DROPBBOX" from the "Cloud Server" dropdown menu. Click "Activate Cloud", and the system will send an activation email to the address configured in Email Setup.

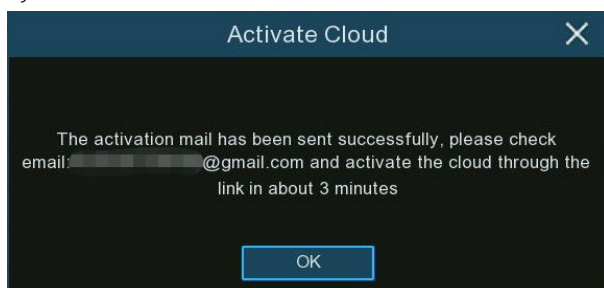

3. Open the email and click the link to go to the cloud server authorization login page. Enter your Dropbox username and password.



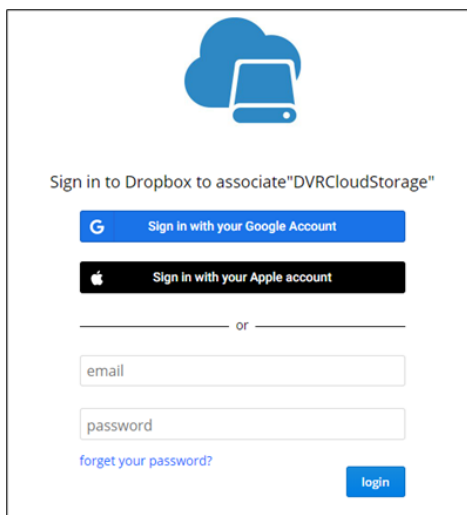

4. Enter the DVR local IP address and web port, then click [Authorize](#).

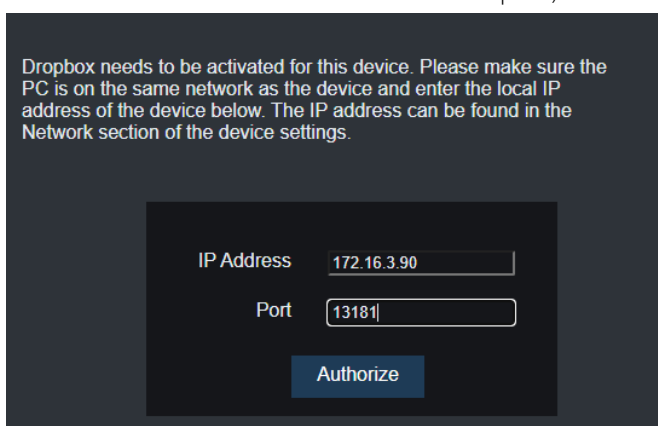

5. Enter the DVR's username and password, then click OK.

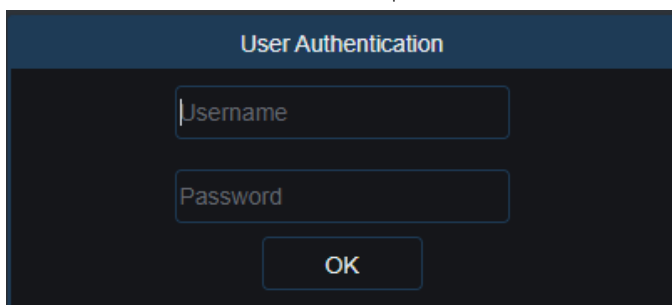

6. Once authorized, the webpage will open your Dropbox.

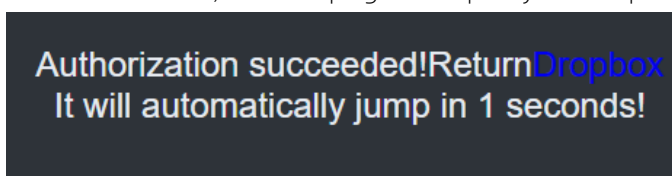

- Cloud setup is complete if you find a new folder named with your NVR's device name and MAC address in Dropbox, where alarm pictures and videos will be uploaded.

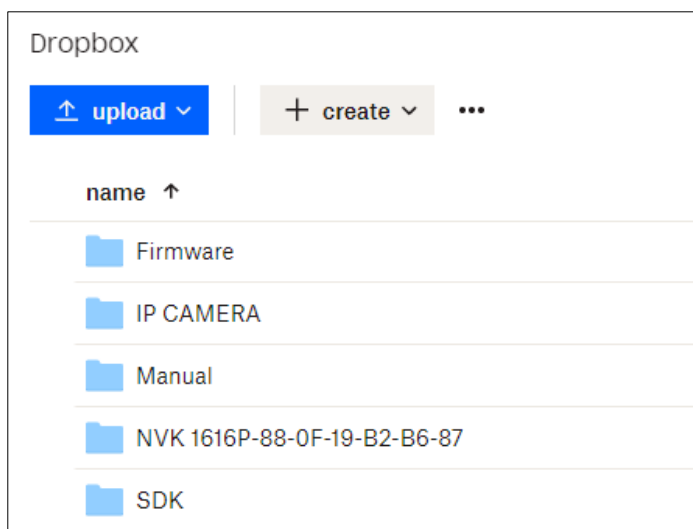

### 5.6.2.2. Google Drive Settings

- Before activation, create a Google Drive account at <https://www.google.com/drive/> if you don't have one.
- Choose "Google Drive" from the "Cloud Server" dropdown menu. Click [Activate Cloud](#), and an activation email with a code will be sent.

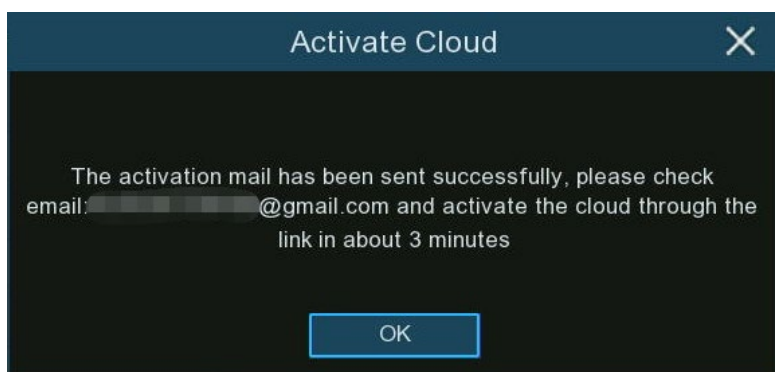

- Open the email, click the link, enter the activation code, and click [Next](#).

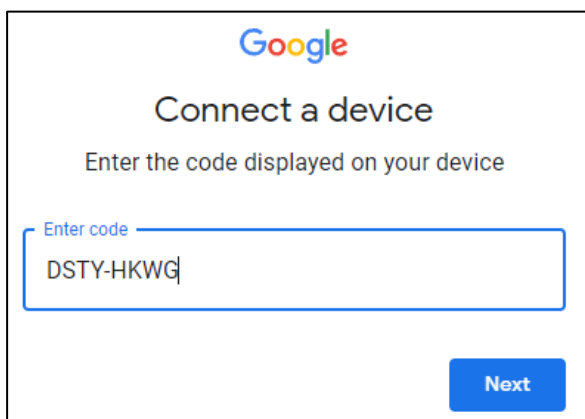

- Enter your Google account credentials to log into Google Drive.

Sign in  
to continue to [CloudStorage](#)

Email or phone  
[redacted]@gmail.com

[Forgot email?](#)

[Next](#)

5. Click **Allow** to complete setting up your Google Drive cloud storage.

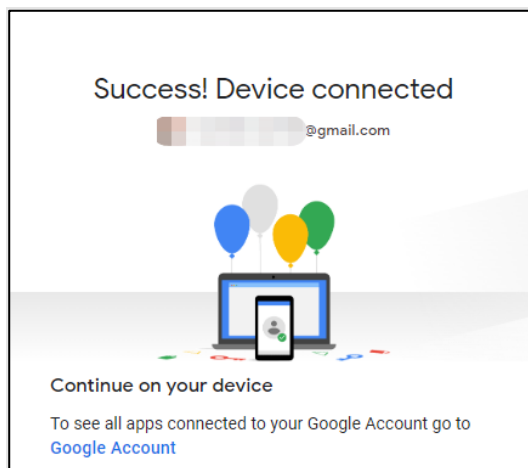
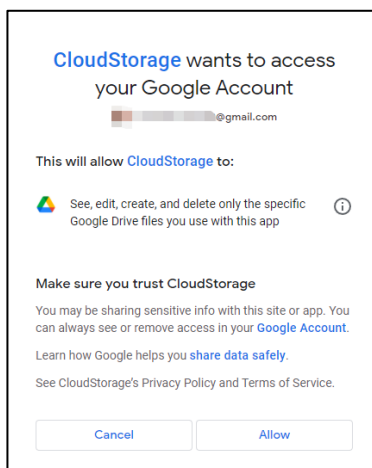

### 5.6.3 FTP

This menu allows you to configure FTP settings for uploading captured snapshots or videos to your FTP server.

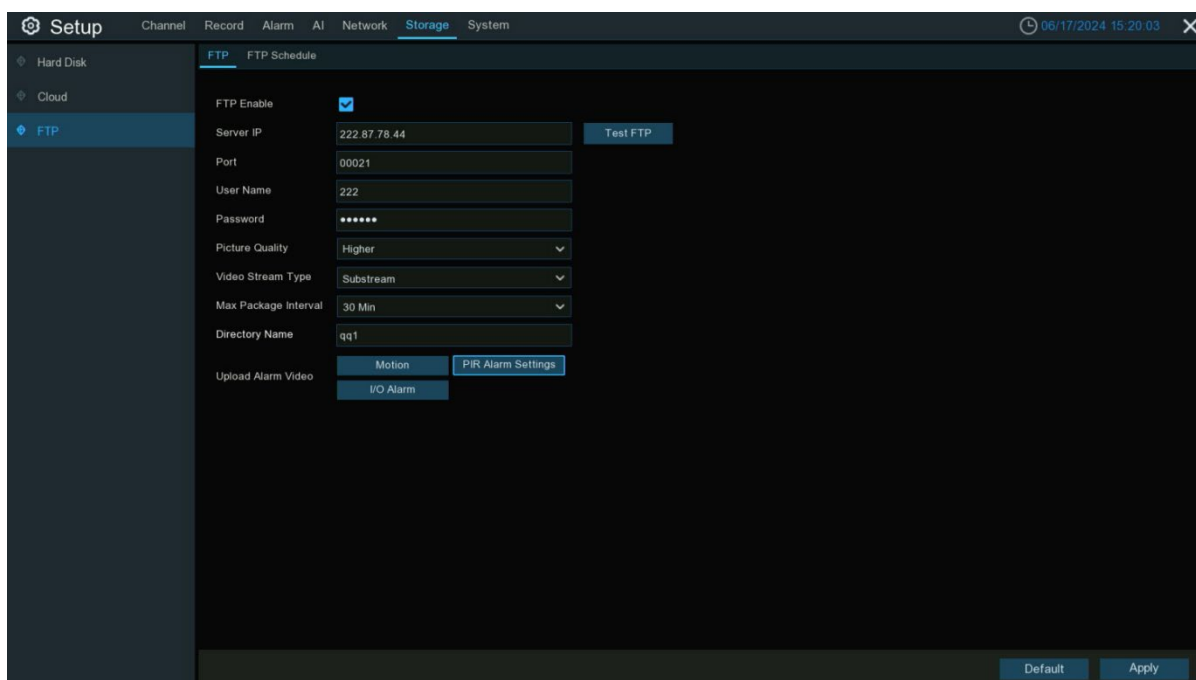

### 5.6.3.1 FTP Settings

FTP   FTP Schedule

FTP Enable

Server IP  [Test FTP](#)

Port

User Name

Password

Picture Quality  ▾

Video Stream Type  ▾

Max Package Interval  ▾

Directory Name

Upload Alarm Video [Motion](#) [PIR Alarm Settings](#) [I/O Alarm](#)

**FTP Enable:** Check this box to enable the FTP function.

**Server IP:** Enter the IP address or domain name of your FTP server.

**Port:** Enter the FTP port for file transfers.

**User Name/ Password:** Enter the username and password for the FTP server.

**Picture Quality:** Select the desired image quality for snapshots to be uploaded to the FTP server.

**Video Stream Type:** Choose whether to upload mainstream or substream video.

**Max Package Interval:** Set the maximum video duration for a single uploaded file. If an event exceeds this duration, a new video file will be created to continue recording.

**Directory Name:** Enter the directory path on your FTP server to save the uploaded pictures and videos.

**Upload Alarm Video:** Set the alarm types for which videos should be uploaded to the FTP server. Click the option to access the configuration menu for each corresponding alarm type.

**Test FTP:** After completing the FTP settings, click this button to verify the configuration. The system will send a test file to your FTP server. If you receive the message "Write to file succeeded!", it means the FTP settings are correct.

### 5.6.3.2 FTP Schedule

If FTP upload is enabled, alarm images or videos are uploaded 24/7 by default. You can schedule when your NVR uploads alarm images/videos, for example only during daytime hours.

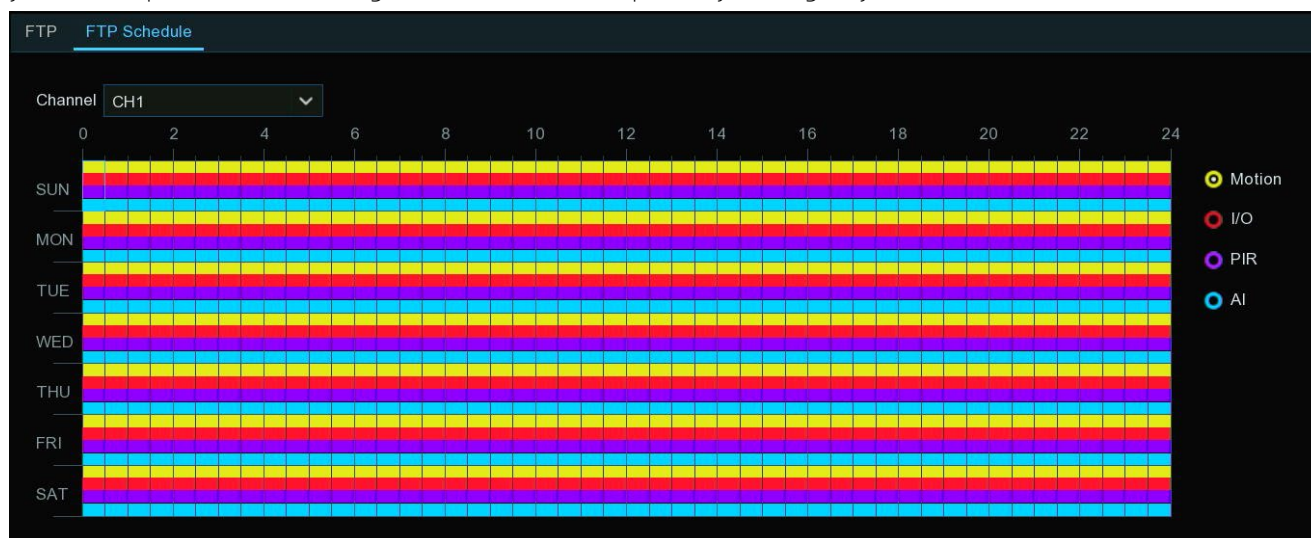

1. Select the camera channel to schedule.
2. Click the checkbox for the alarm type to upload:
  - **Motion:** Upload for motion detection alarms
  - **I/O:** Upload for I/O triggered alarms
  - **PIR:** Upload for PIR detection alarms
  - **AI:** Upload for Intelligent/AI detection alarms
3. Use the mouse to Click /drag over time squares to set the desired schedule.
4. Repeat steps 2-3 for other alarm types.
5. The schedule only applies to the selected channel. Use the [Copy](#) function to apply it to other channels.
6. Click [Apply](#) to save settings.

## 5.7 System Configuration

Change system information such as date, time and region, change passwords and permissions, and more.

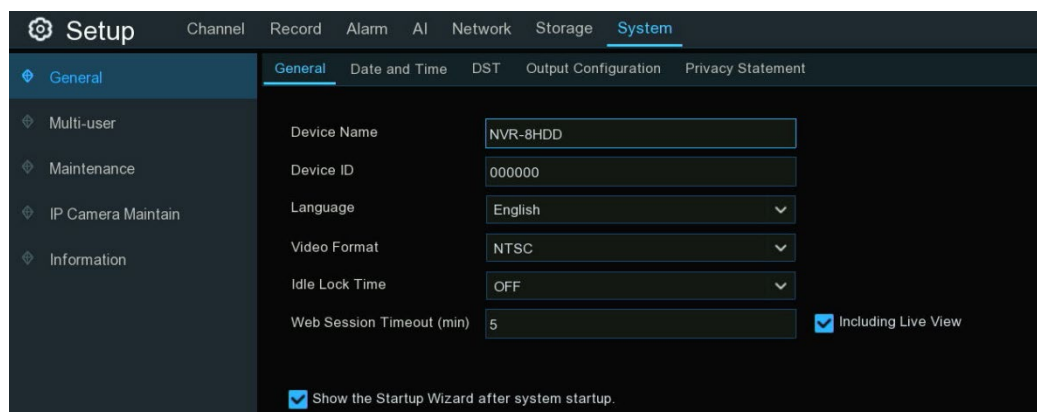

Change general system information such as date, time and region, edit passwords and permissions and more.

### 5.7.1 General

#### 5.7.1.1 General

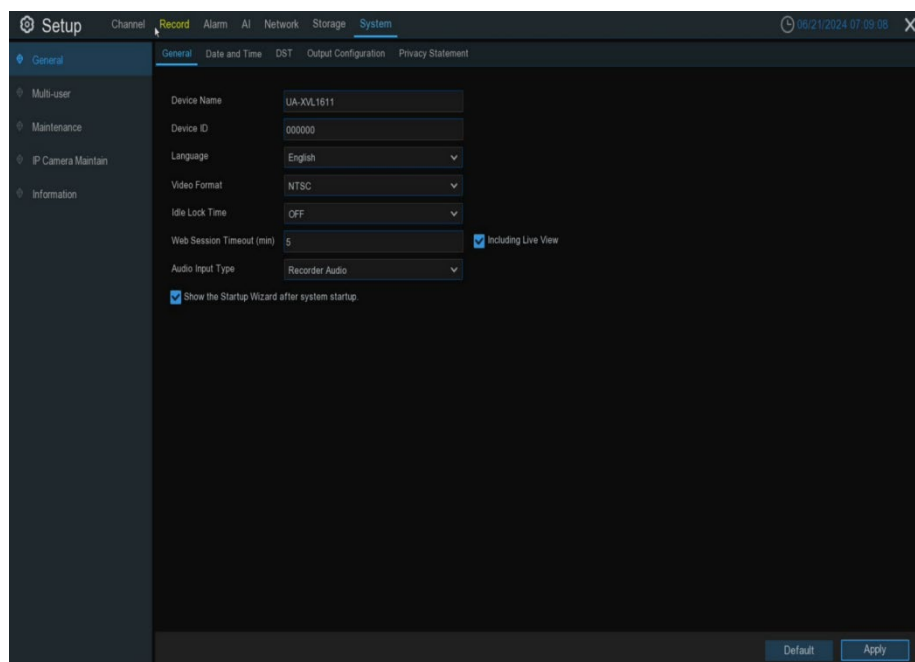

**Device Name:** Enter the DVR name. The name can contain letters and numbers.

**Device ID:** Enter the DVR device ID. The device ID is used to identify the DVR and can only be made up of numbers. For example, two DVRs are installed in the same location, one of which has a device ID of

000000, and the other has a device ID of 111111. When you want to operate a DVR with the remote control, both DVRs may receive signals from the controller and act at the same time. If you only want to control the DVR with ID 111111, you can use the remote control to enter the device ID 111111 in the login page for further operation.

**Language:** Select the language in which you want to display the system menu. Multiple languages are available.

**Video Format:** Choose a video format that suits your region.

**Menu Timeouts:** Click the drop-down menu and select the time to exit the main menu when the DVR is idle. You can also disable this function by selecting off (password protection will be temporarily disabled)

**Web Session Timeout (min) :** Set the time to automatically log out of the web after a period of no operation when using the web side to log in. The system default is 5minutes, adjustable from 5-1440minutes.

**Preview/Playback Session Timeout:** After enable, in the preview or playback, to avoid automatic logout of the web side.

**Mode:** XVR or DVR, XVR mode will allow you to add IP cameras to the DVR. If the mode is changed from XVR to DVR, all added IP cameras will be removed.

**Audio Input Type:** Select analog channels input audio type, select **Base-band Audio**, it's DVR hardware audio input interface. Select **Coaxial Audio**, it's analog camera audio input via BNS interface.

**Show Wizard:** Check this option if you want to display the startup wizard every time you open or restart a DVR.

## 5.7.1.2 Date and Time

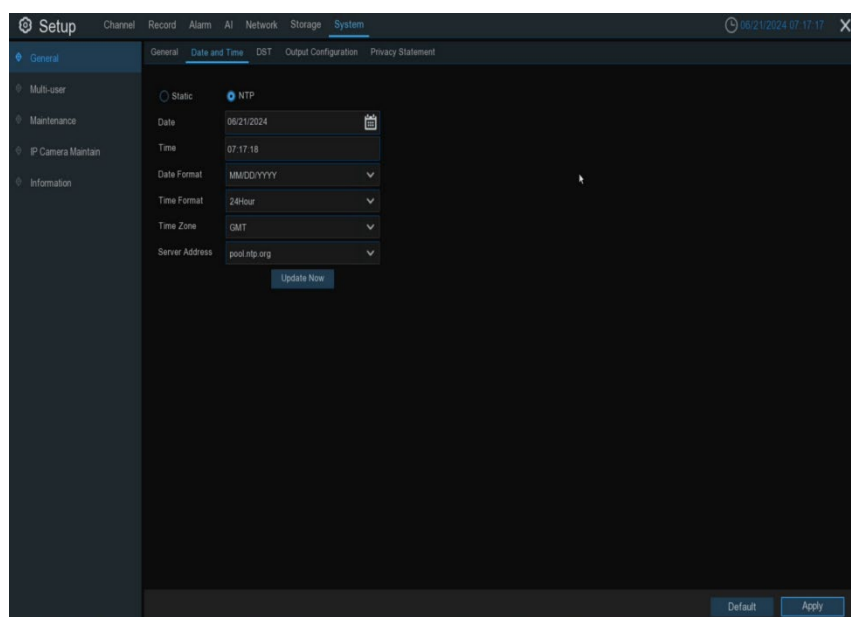



### 5.71.2.1 Date & Time

**Date:** Click  to change the date.

**Time:** Click the time box to change the time.

**Date Format:** Select the preferred date format.

**Time Format:** Select the preferred time format.

**Time Zone:** Select the time zone associated with your region or city.

### 5.71.2.2 NTP

The NTP (Network Time Protocol) function allows your DVR to automatically sync its clock with a time server. This gives it the ability to constantly have an accurate time setting (your DVR will periodically sync automatically).

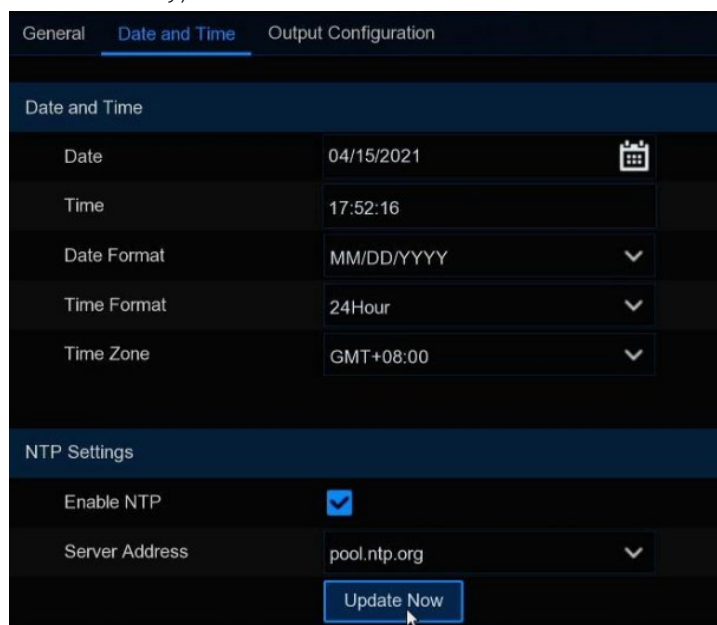

Check to enable the **NTP**, and select a **Server Address**, click **Update Now** to manually sync the date & time.

Click **Apply** to save your settings.

When NTP function is enabled, system will update the system time at 00: 07: 50 per day, or every time when the system is starting up.

### 5.7.1.2.3 DST

The DST (Daylight Saving Time) function allows you to select the amount of time that Daylight Saving has increased by in your particular time zone or region.

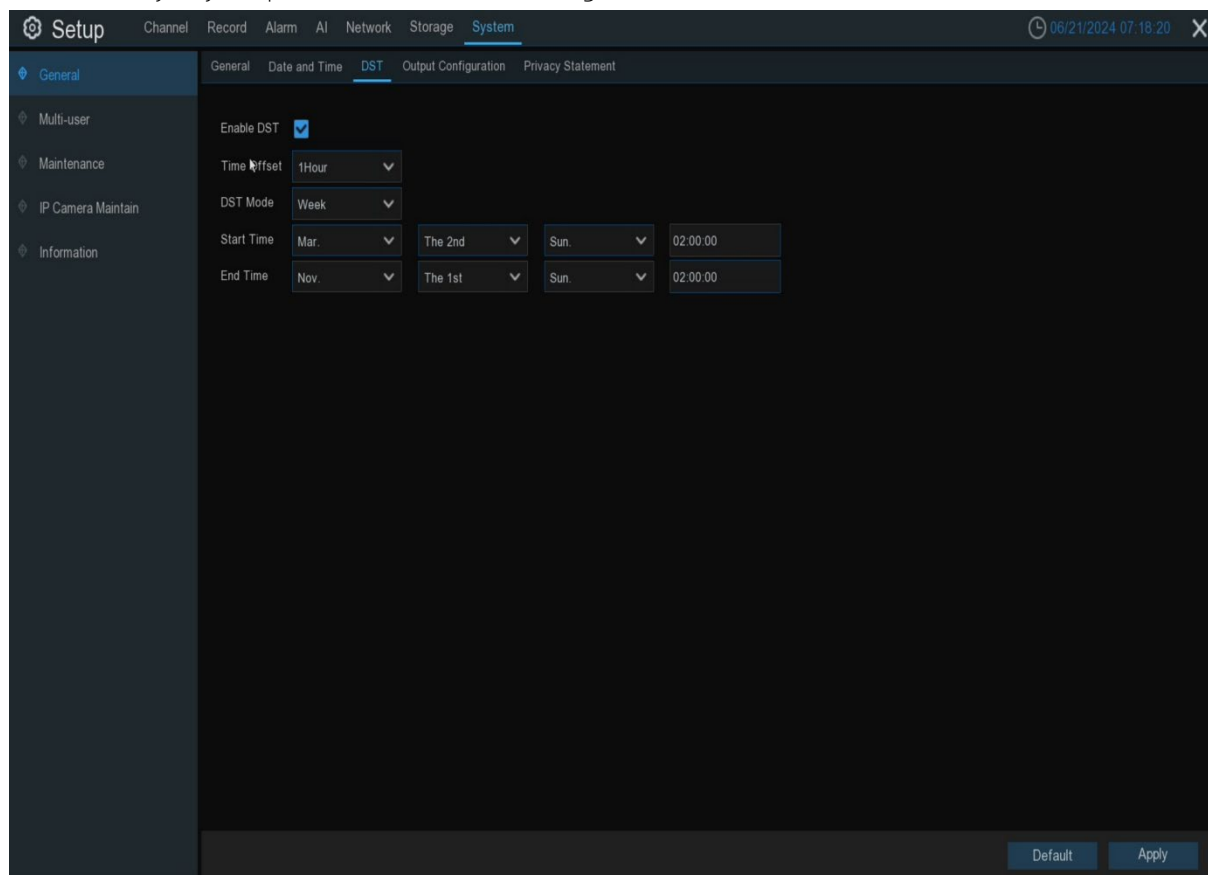

**Enable DST:** If Daylight Saving applies to your time zone or region, check this option to enable.

**Time Offset:** Select the amount of time that Daylight Saving has increased by in your time zone. This refers to the difference in minutes, between Coordinated Universal Time (UTC) and the local time.

**Enable DST:** You can select how Daylight Saving starts and ends:

**Week:** Select the month, a particular day and time when Daylight Saving starts and ends. For example, 2 am on the first Sunday of a particular month.

**Date:** Select the start date, end date and time when Daylight Saving starts and ends.

**Start Time / End Time:** Set the start time and end time for Daylight Saving.

### 5.7.1.3 Output Configuration

This menu allows you to configure video output parameters.

**Video Output:** To choose the output options.

**LIVE-OUT** is used to configure the main output parameters.

**SPOT-OUT** is an optional option to configure the HDMI spot output parameters.

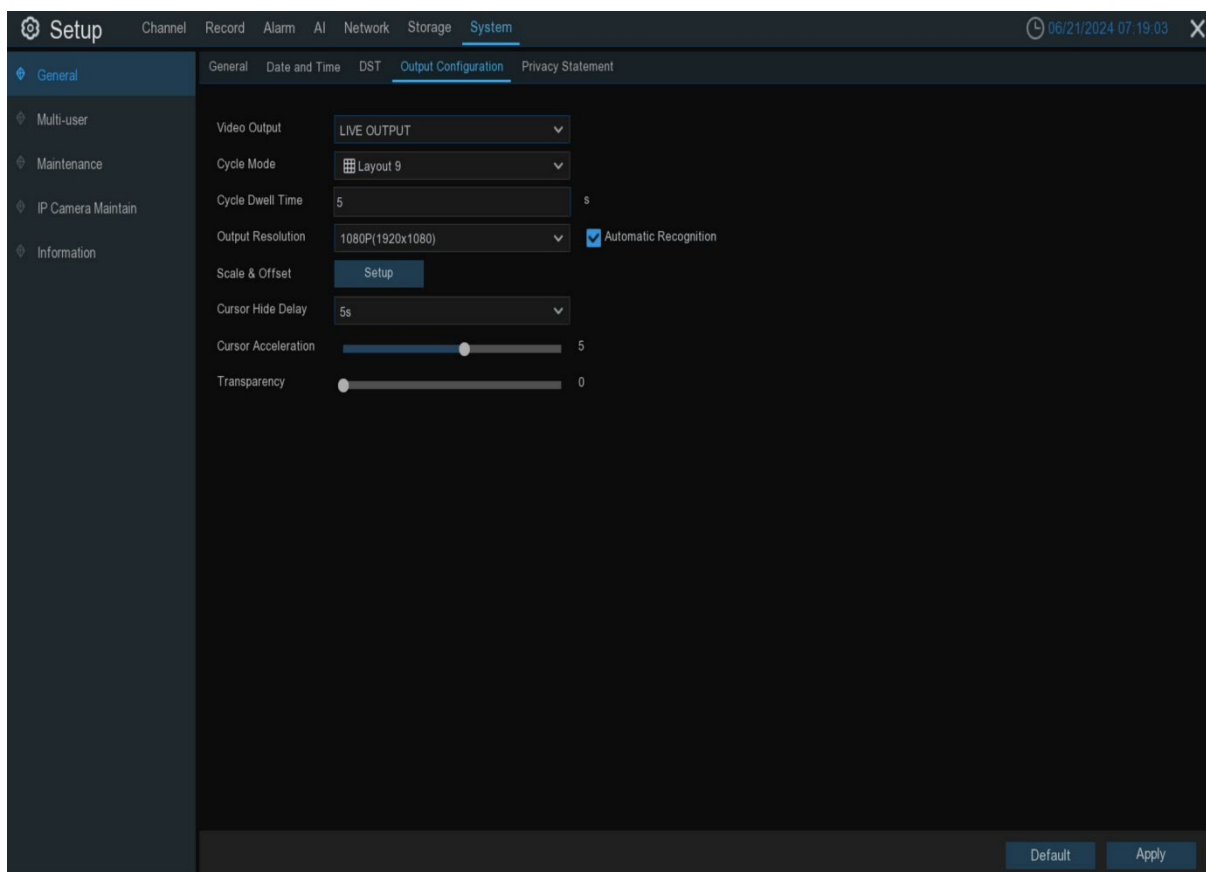

**Video Output** drop-down select **LIVE-OUT** mode.

**SEQ Mode:** Choose the number of video channels to be displayed when the DVR is in the wheel patrol mode.

**SEQ Dwell Time:** Enter in seconds the maximum length of time you would like to display a video channel in sequence mode before displaying the next video channel (300 seconds is the maximum).

**VGA/HDMI Resolution:** Select a display resolution that is suitable for your TV. 1920 x 1080 will suit most TVs. If your DVR supports 4K output resolution, you can select either 2K (2560 x 1440) or 4K (3840 x 2160) to take advantage of the higher resolution that your 4K TV provides.

**Automatic recognition:** Automatically recognize the resolution, the resolution of the display of the display when it is checked after checking, prompting the appropriate resolution.

**Scale And Offset:** The DVR supports to adjust the size & position of the display screen to match your monitor or TV. Click **Setup** button to adjust.

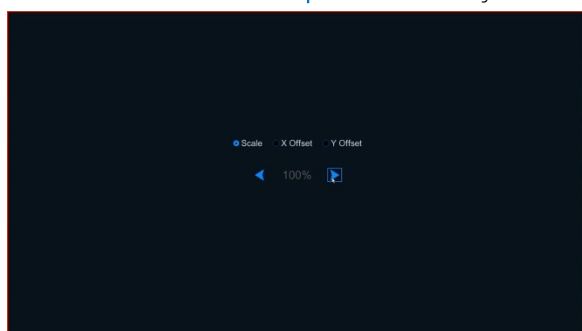

**Scale:** To adjust the size of the displayed screen by scale.

**X Offset:** To move the displayed screen to left or right.

**Y Offset:** To move the displayed screen to up or down.

Click once or long press the left button of your mouse on the arrow to adjust the size and position, or you can scroll the wheel of the mouse to adjust. Click the right button of your mouse to exit, and click **Apply** to save your modifications.

**Cursor Hidden Delay:** Click the drop-down menu to select the time your DVR will hide the mouse cursor when idle. You can also disable this by selecting “OFF” (password protection will be temporarily disabled).

**Cursor Acceleration:** To adjust the speed to move the mouse cursor.

**Transparency:** Click and hold the slider left or right to change how transparent the Menu Bar and Main Menu will appear on-screen. Adjust accordingly.

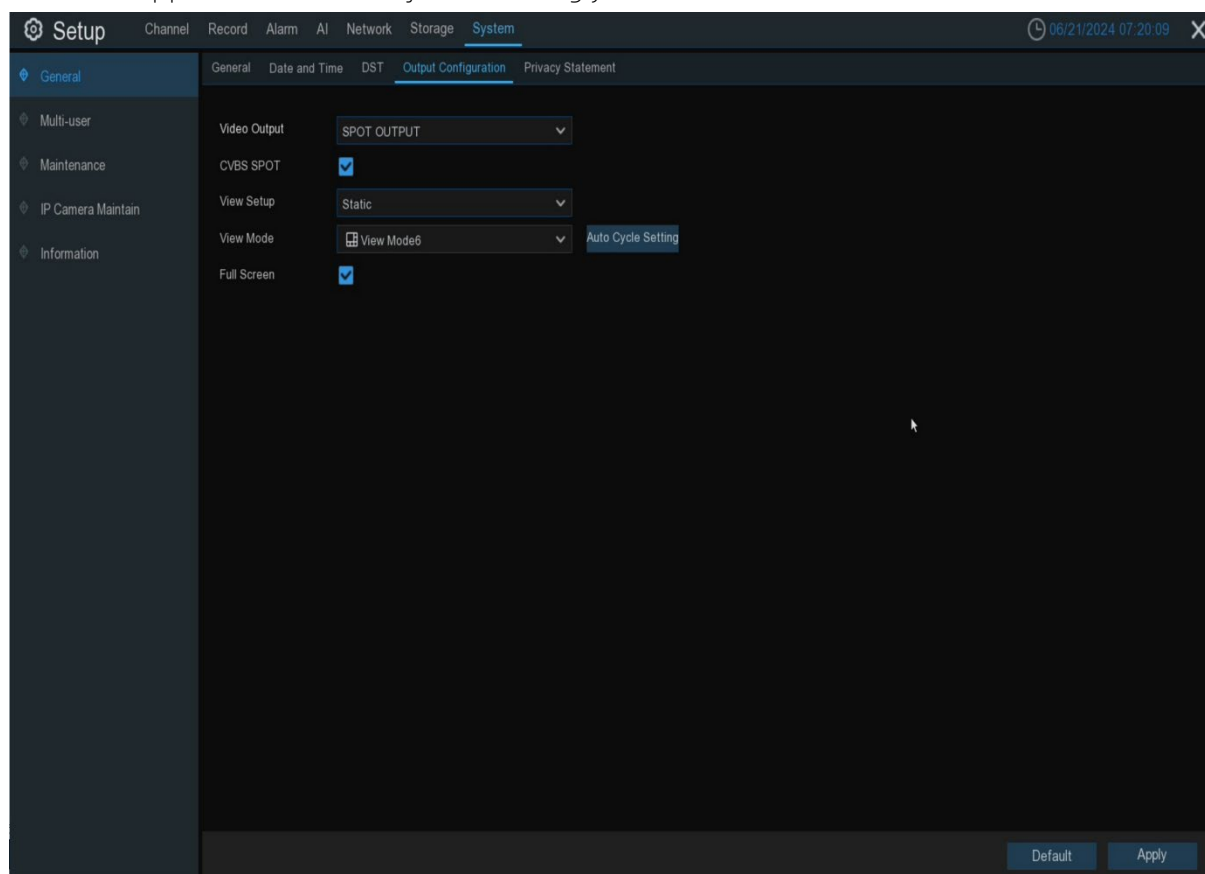

**Video Output:** Drop-down menu to select **SPOT-OUT** mode.

**CVBS SPOT:** Click to enable **CVBS** interface to output video.

**View Setup:** select **CVBS** interface to set up display output modes, **Dynamic** and **Static**.

**SEQ Mode:** Select **Dynamic** mode to show the video channels on SEQ.

**SEQ Dwell Time:** Enter in seconds the maximum length of time you would like to display a video channel in sequence mode before displaying the next video channel (300 seconds is the maximum).

**Full Screen:** While trigger alarm to show this channel to full screen.

**Spot Poll Setting:** Select **Dynamic** mode to SEQ channels.

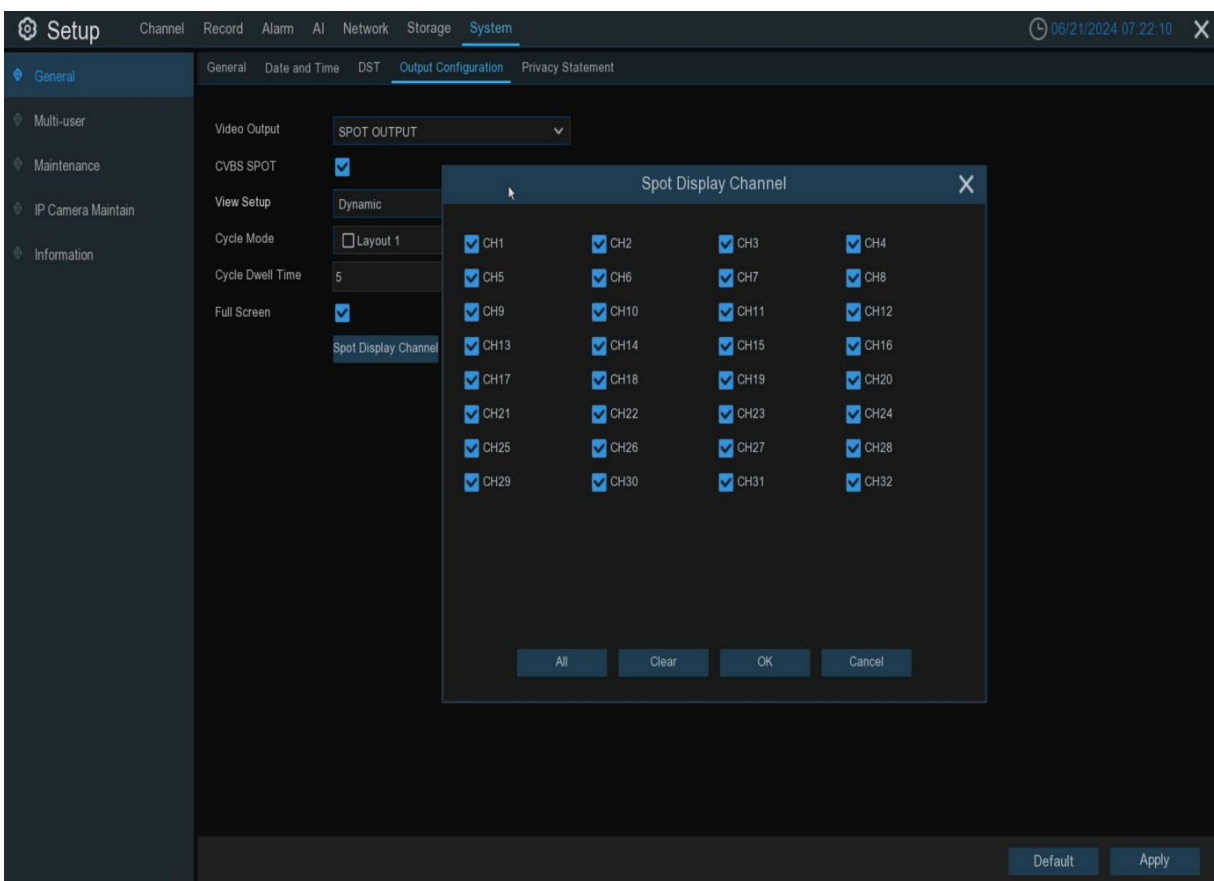

**View Mode:** Select **Static** mode multi-window number.

**Define SEQ Setting:** Select **Static** mode each window display.

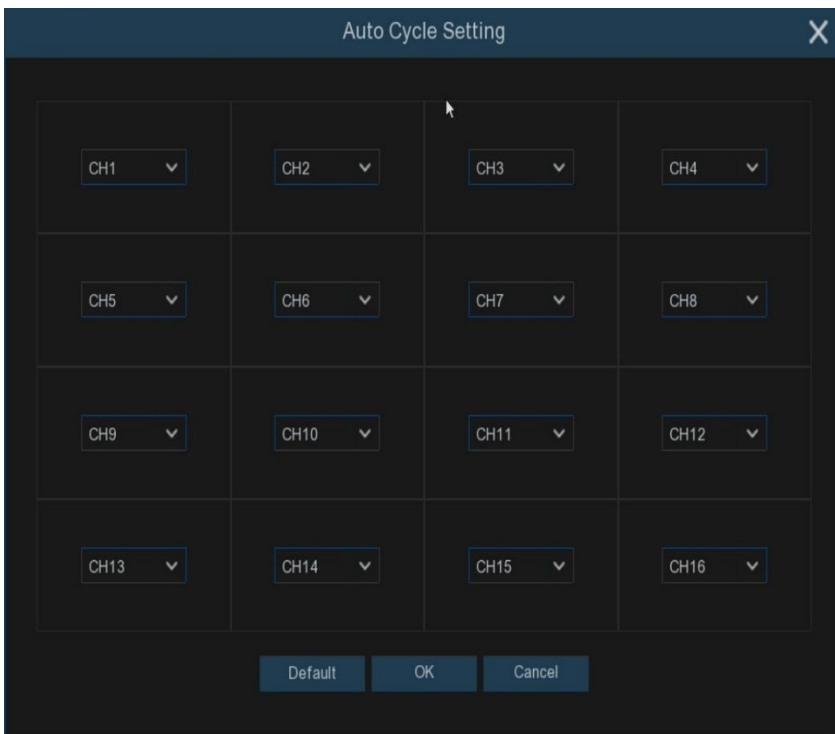

## 5.7.2 Multi-user

This menu allows you to configure the user name, password and user permission.

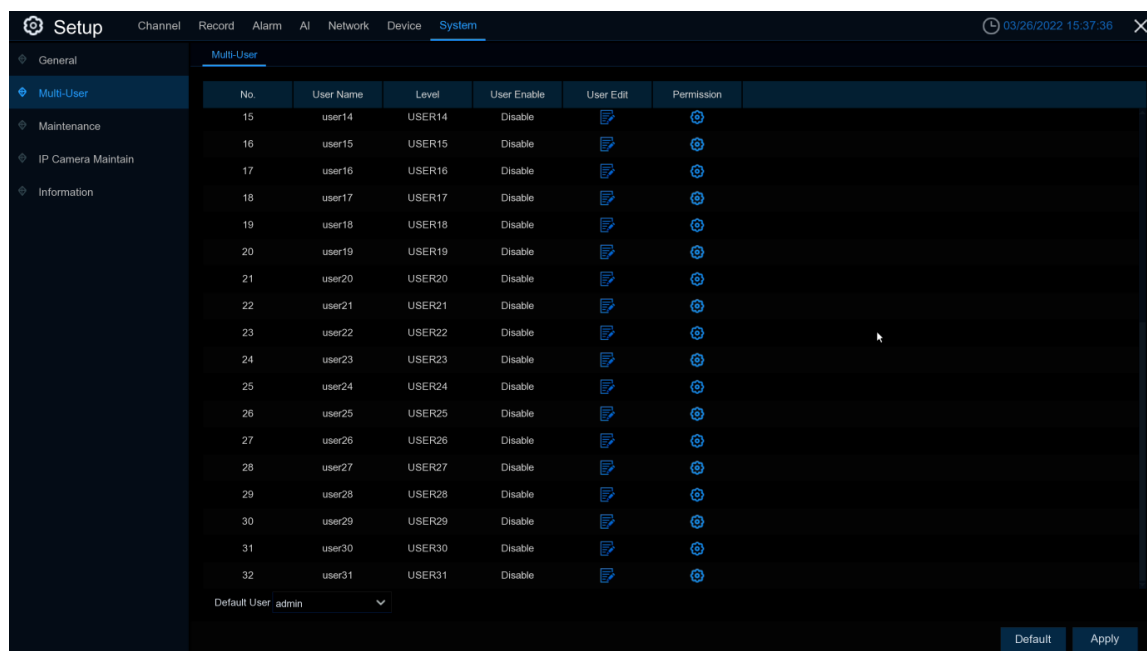
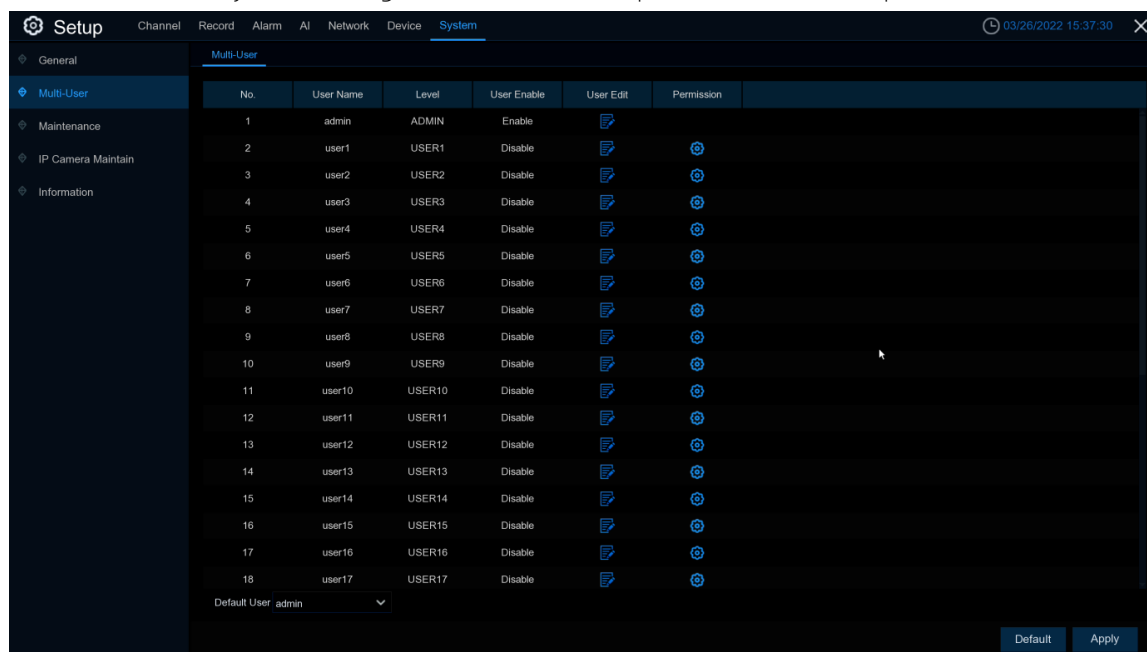

The system supports the following account types:

- **ADMIN** — **System Administrator**: The administrator has full control of the system, and can change both administrator and user passwords and enable/disable password protection. (8.2.2 and above version won't be allowed to change administrator password and name.)
- **USER** — **Normal User**: Users only have access to live viewing, search, playback, and other functions. You may set up multiple user accounts with varying levels of access to the system. (8.2.2 version and above support maximum 31 normal users account.)

**Default User:** Default account, the user which default to login when DVR start up.

### 5.7.2.1 Changing Password and single user number

To change the password for the administrator or user accounts, click the User Edit icon . The password has to be a minimum of 8 characters and can contain a mixture of numbers and letters. Enter your new password again to confirm, and then click **Save** to save your new password. You will be required to input your old password to authenticate.

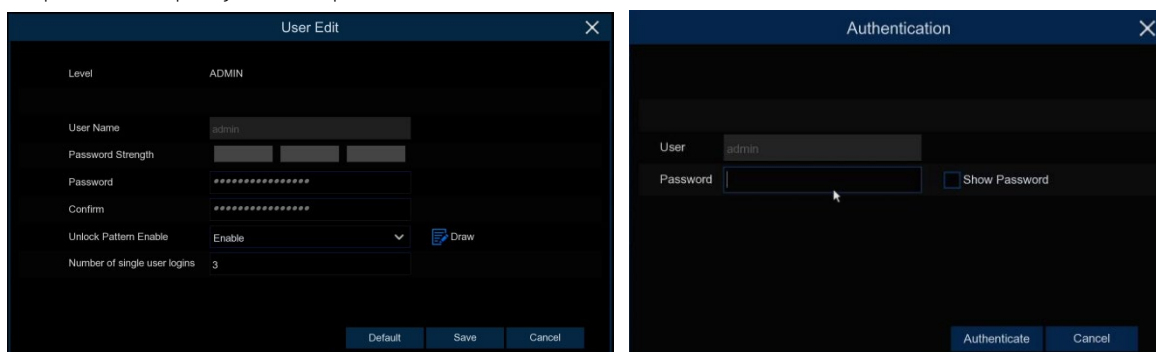

### 5.7.2.2 Add New Users

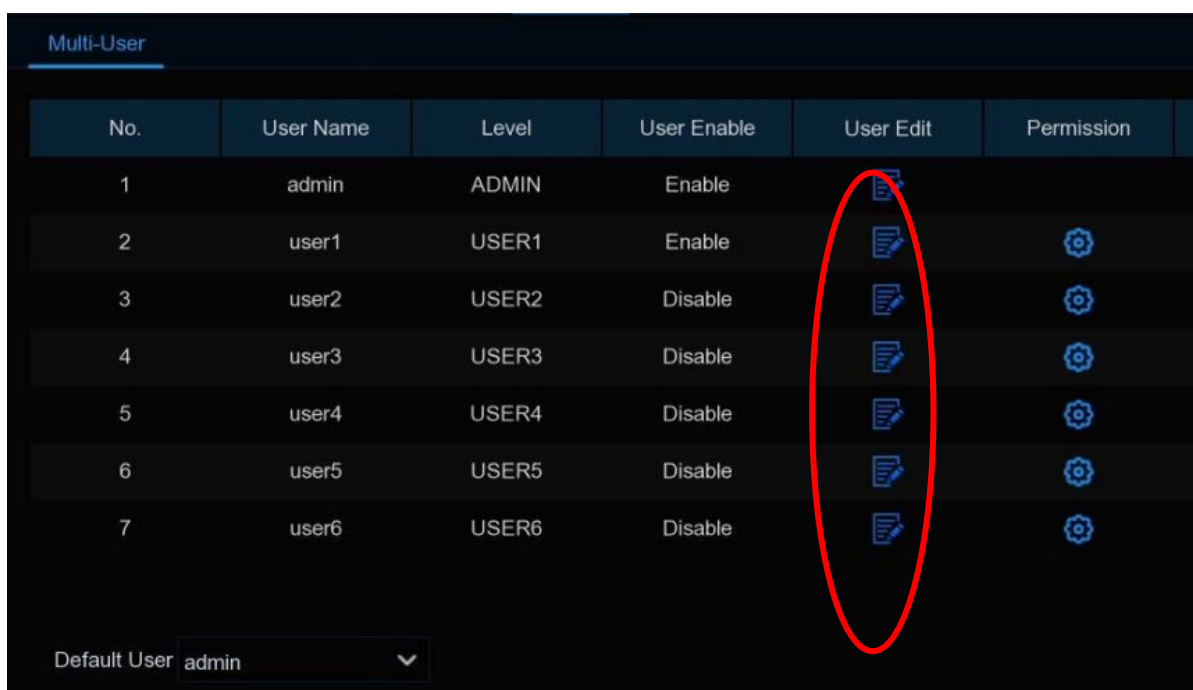

1. Select one of the user accounts that is currently disabled, click the User Edit icon .

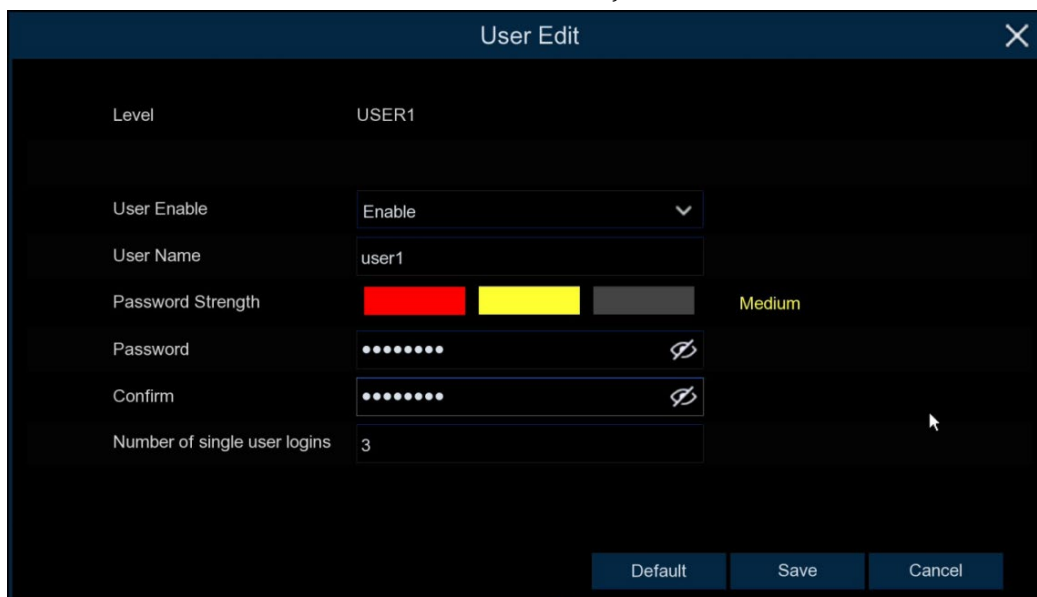









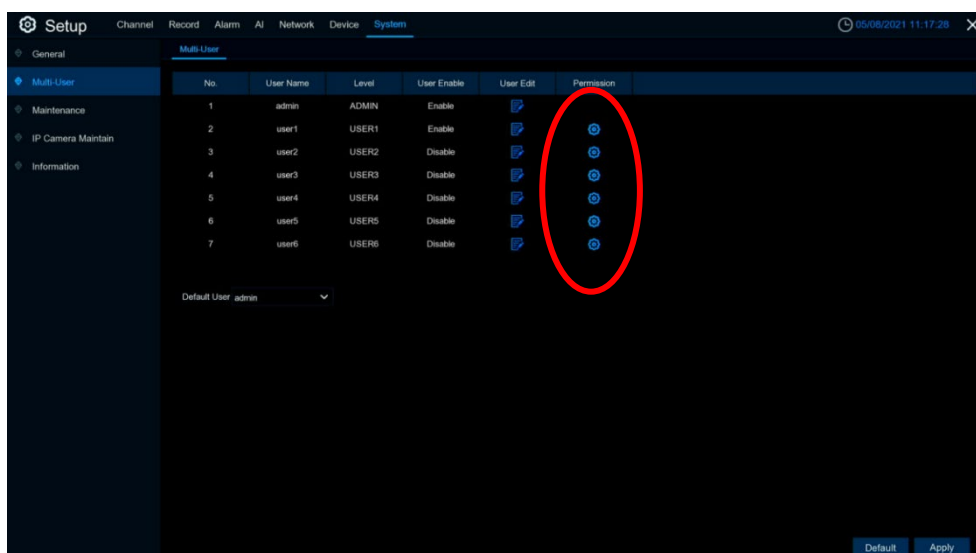





The 'User Edit' dialog box shows the configuration for 'USER1'. The 'Level' is set to 'USER1'. The 'User Enable' dropdown is set to 'Enable'. The 'User Name' field contains 'user1'. The 'Password Strength' is indicated as 'Medium' with a progress bar showing red, yellow, and grey segments. The 'Password' and 'Confirm' fields are masked with dots and have copy icons. The 'Number of single user logins' is set to '3'. At the bottom, there are 'Default', 'Save', and 'Cancel' buttons.

2. Select **Enable** from the drop-down next to **User Enable**.
3. Click the field next to **User Name** to change the user name for the account.
4. Select **Enable** from the drop-down next to **Password Enable**.
5. Click the field next to **Password** to enter the desired password.
6. Click the field next to **Confirm** to reenter the password.
7. Click **Number of single user logins** to set single user logins.
8. Click **Save**. You will be required to input your Admin password to authenticate.

### 5.7.2.3 Setting User Permissions

The administrator account is the only account that has full control of all system functions. You can enable or disable access to certain menus and functions of each user account.



No.	User Name	Level	User Enable	User Edit	Permission
1	admin	ADMIN	Enable		
2	user1	USER1	Enable		
3	user2	USER2	Disable		
4	user3	USER3	Disable		
5	user4	USER4	Disable		
6	user5	USER5	Disable		
7	user6	USER6	Disable		

The 'Permission' column contains icons for each user, which are circled in red in the original image. The 'Default User' is set to 'admin'.



1. Click the edit icon  under Permission tab

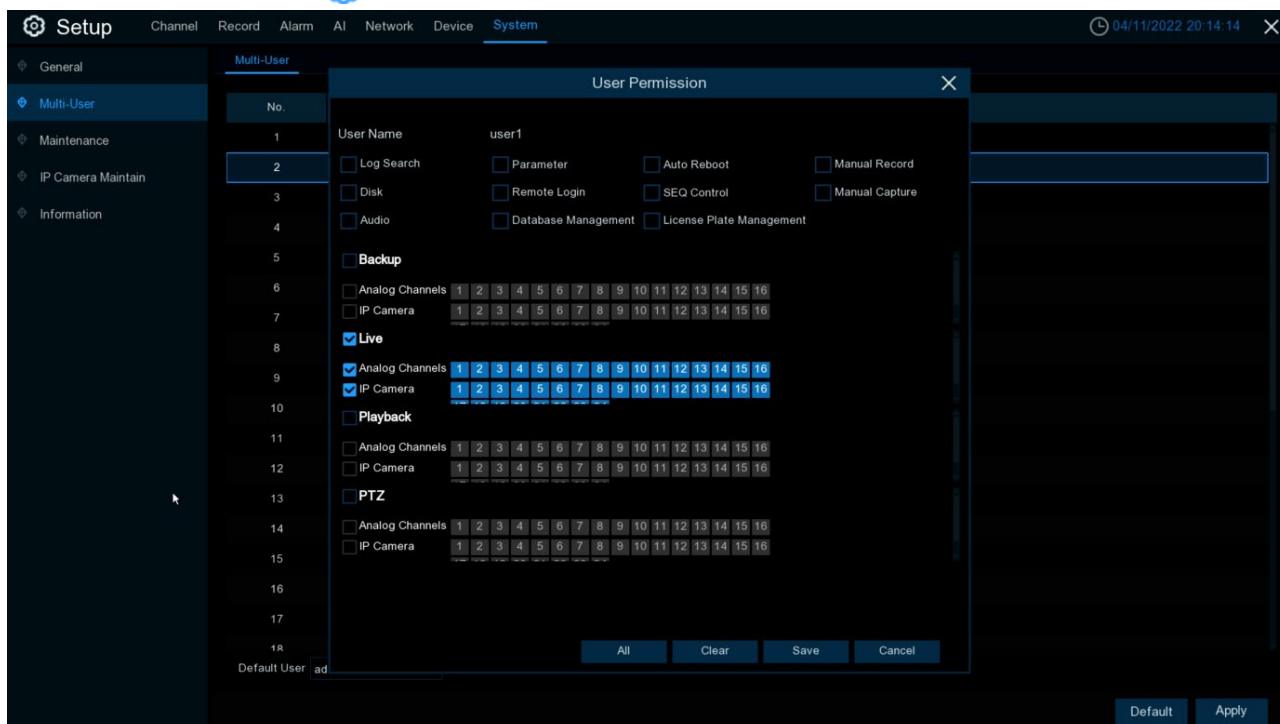

Check the boxes next to any system menus or capabilities you would like the user to access. Click **All** to check all boxes. Click **Clear** to check none of the boxes.

There is the following permissions to choose from:

- **Log search:** To see all of logs.
- **Parameter:** To set up all of pages parameters.
- **Maintenance:** Operation System version update, load to default settings, device reboot, device shut down and etc.
- **Manual Record:** Manually start the video and stop the video manually.
- **Disk:** Control and manage HDD and U-disk.
- **Remote Login:** Whether have permission to visit DVR remotely.
- **SEQ Control:** View the real-time preview of all channels.
- **Manual capture:** Manually start the grabbing and can stop the video manually.
- **Audio:** Control channel audio and intercom.
- **Database Management:** Whether it can be operated on the AI database
- **License Plate Management:** Whether it can be operated on the License Plate database
- **Backup:** After the enable box "√" in front of "backup" and select-able channels, ordinary users have the permissions of the selected channel video.
- **Live:** After the enable box "√" in front of "Preview" and the passage that can be viewed, the ordinary users have the permissions of the real-time preview of the selected channel.
- **Playback:** After the enable box "√" in front of "video playback" and the selected channel that can be viewed, ordinary users have the permissions of the selected channel video.

- **PTZ:** After the enable box "√" in front of "PTZ" and select-able channels, ordinary users have the permissions of PTZ operations.

2. Click **Save** button to apply your modifications.

## 5.7.3 Maintenance

In this section, you will be able to search & view the system log, load default settings, upgrade the system, export & import system parameters and manager system auto reboot.

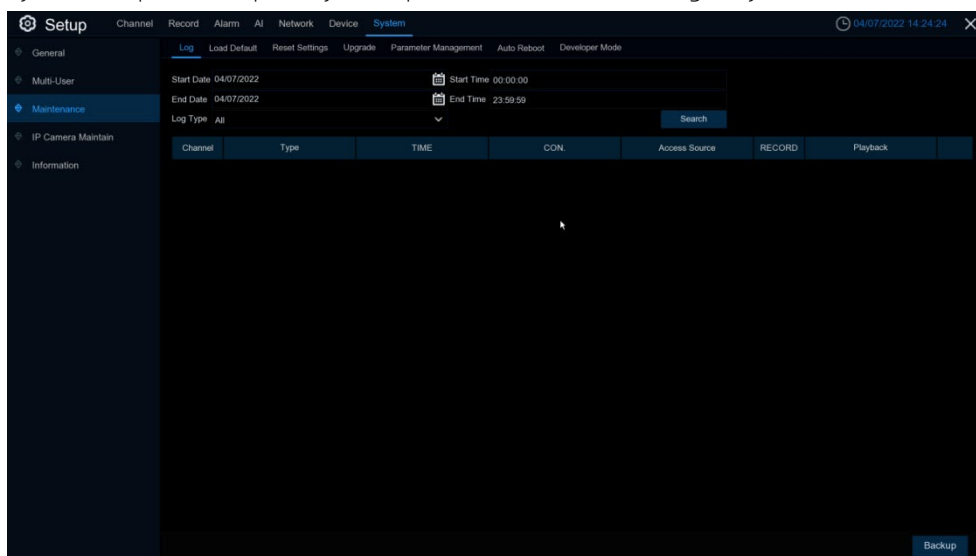

### 5.7.3.1 Log

The system *log* shows you important system events, such as motion alarms and system warnings. You can easily create a backup file of the system *log* for a set time period to a USB flash drive.

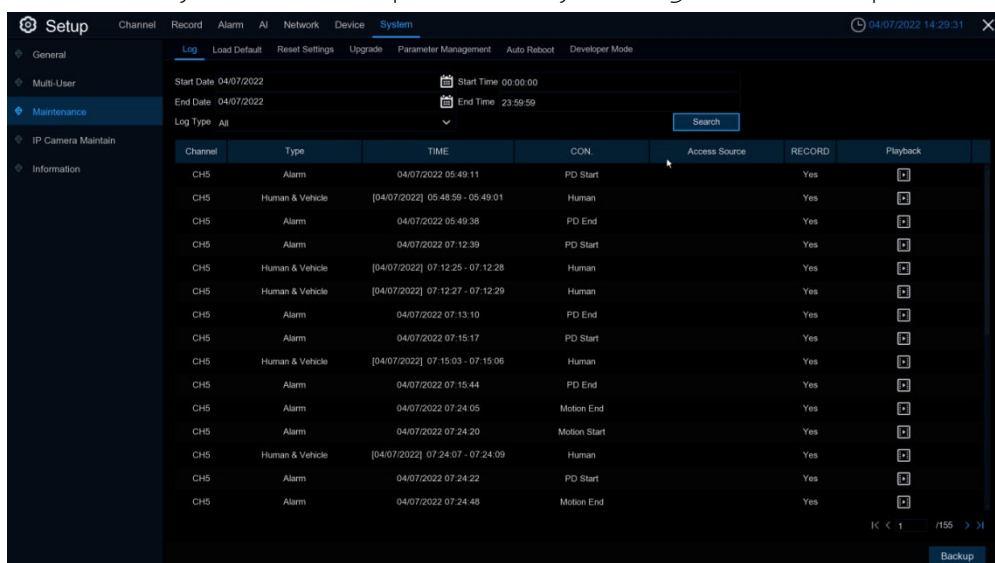

**Log search and backup:**

1. Click the field next to **Start Date & Start Time** to choose the starting date & time for your search from the on-screen calendar.
2. Click the field next to **End Date & End Time** to choose the end date & time for your search from the on-screen calendar.
3. Select the type of events you would like to search for from the drop-down next to **Log Type**, or select **All** to see the entire system log for the selected time period.

**system:** System setting, reboot, auto reboot, upgrade, time modify and NTP.

**configuration:** IPC preview control, Privacy areas settings, recording mode settings, recording plan settings, main code flow settings, network settings, sub-code stream settings, email settings, color settings, mobile detection settings, hard disk settings, multi-user settings, NTP settings, image control, mobile, mobile Code flow settings, RTSP settings, IP filter settings, system restoration of factory settings, audio settings, video blocking alarm settings, export settings and import settings.

**alarm:** Motion start, Motion end, IO start, IO end, Perimeter Intrusion start, Perimeter Intrusion end, Line Crossing Detection start, Line Crossing Detection end, Object Detection start, Object Detection end, Pedestrian & Vehicle start, Pedestrian & Vehicle end, Face Detection start, Face Detection end, Cross Counting start, Cross Counting end, Crowd Density start, Crowd Density end, Queue Lenth start, Queue Lenth end, Sound Detection start, Sound Detection end.

**account:** Login, logout and switch users.

**recording:** search, playback and records backup.

**storage:** Format HDD, HDD Full and HDD error.

**network:** Network down, Network up, Network error and Network mode changes

4. **Search**

5. Browse the system log from the time period:
  - o Click **Playback** to playback the event.
  - o Using menu right down **◀ < / > ▶** button to switch different pages.
6. Click **Backup** to create system log backup. Make sure your u disk connect to DVR USB port.
7. Show backup drive menu, lead to backup folder and click **OK** button to start.

### 5.7.3.2 Load Default

Reset the DVR settings to its out-of-box state. You can choose to reset all settings at once, or just settings on specific menus. Restoring default settings will not delete recordings and snapshots saved to the hard drive.

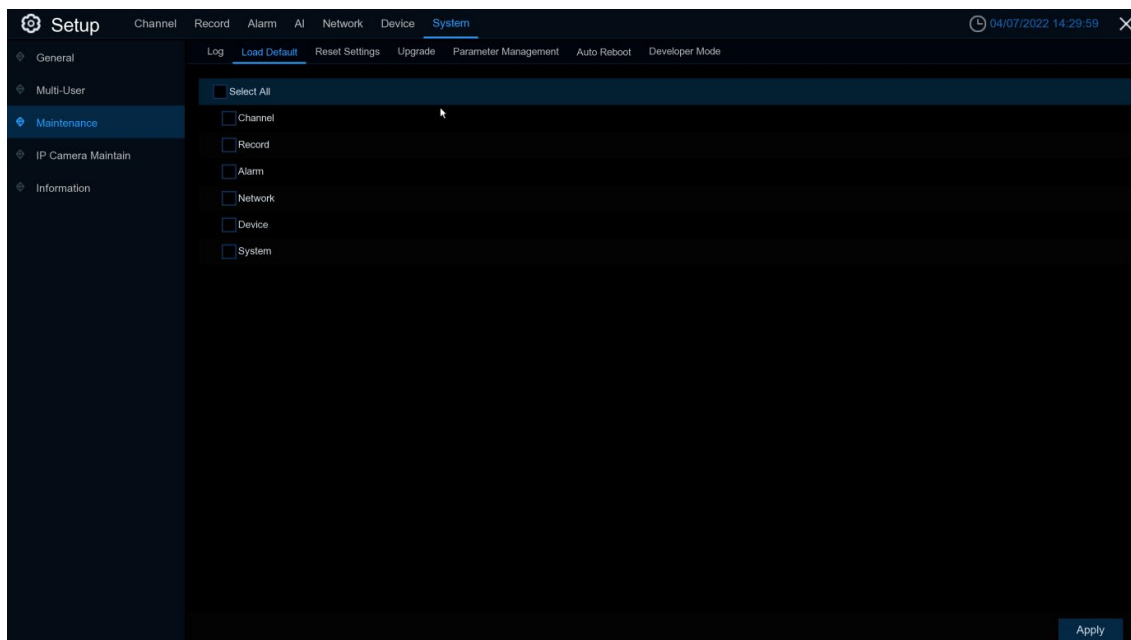

Check the items you want restore, or check [Select All](#) to choose all items. Click [Apply](#) to load default settings of your chosen items.

### 5.7.3.3 Reset Settings

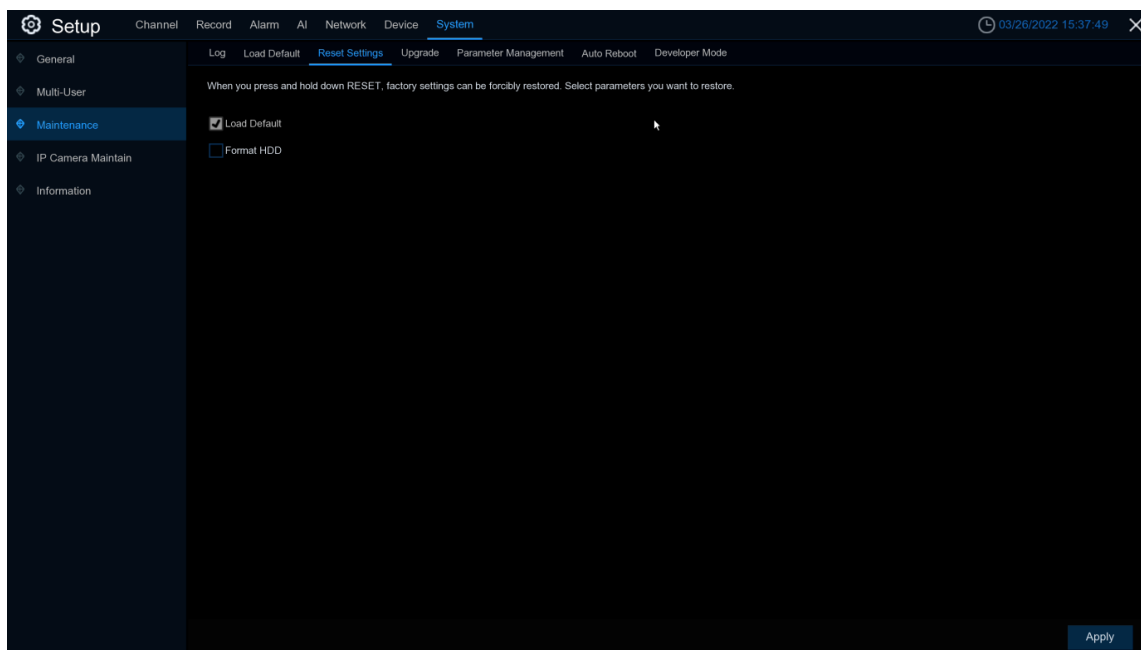

[Format HDD](#): Set up to format HDD when make setting to default.

## 5.7.3.4 Upgrade

### 5.7.3.4.1 U disk file upgrade

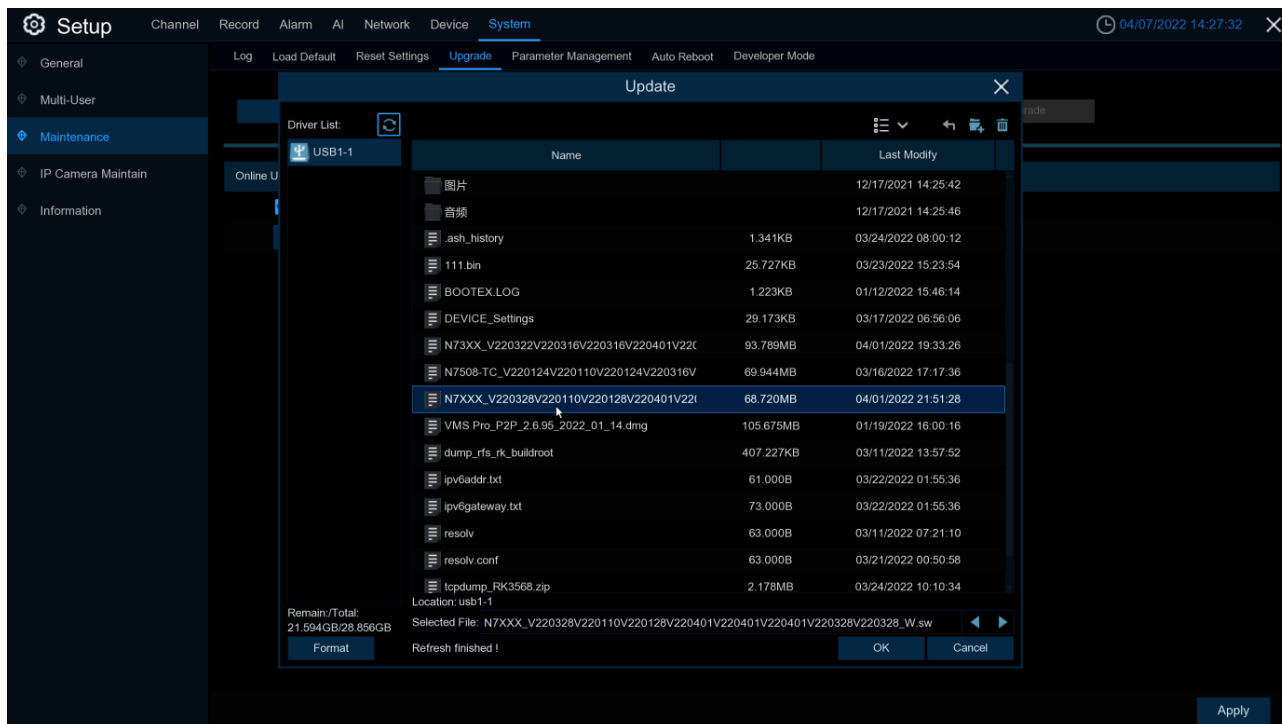

1. Copy the firmware file (.sw file) to your USB drive, and insert the USB flash drive into the DVR's USB port.
2. Click **Select File** button to choose the firmware file in your USB flash drive, then click **OK**.
3. Click **Upgrade** button to start system upgrade. The system upgrade will last around 5-10 minutes, please **DO NOT** power off the DVR or remove the USB from DVR during firmware upgrade.

### 5.7.3.4.2 Online upgrade

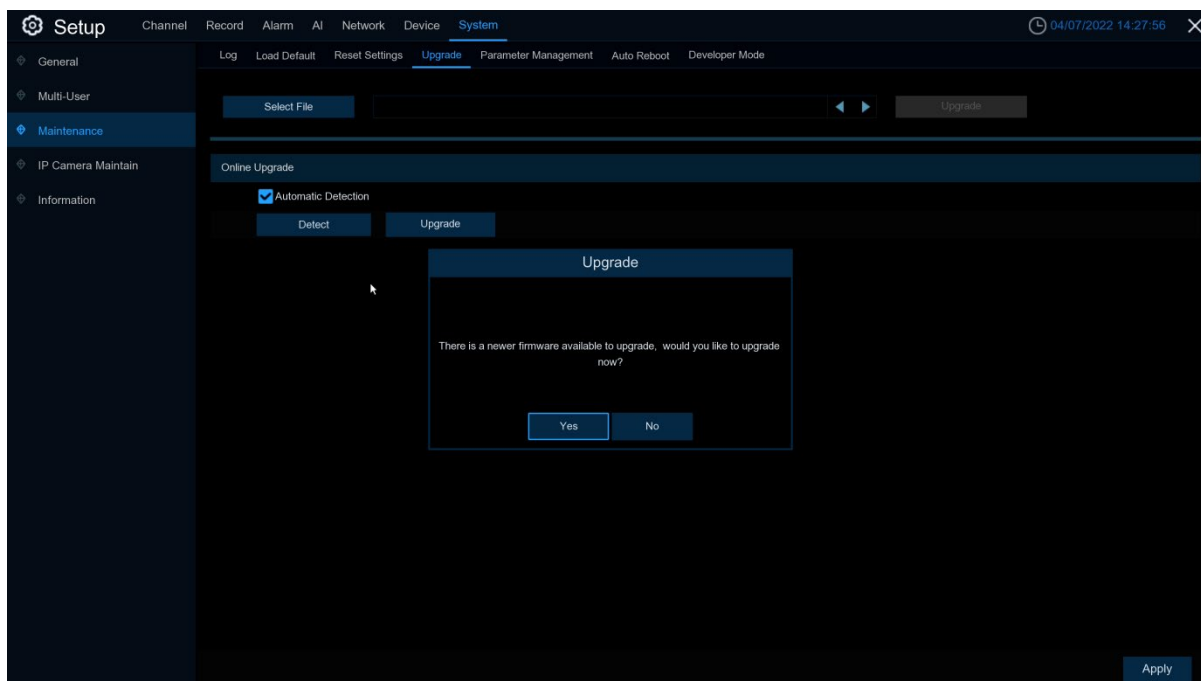

After uploading the upgrade firmware to the server path completely. Click **Detect** button to detect online upgrade file manually. Enable **Automatic Detection**---Detect the upgrade file automatically.

(1) When turn on **automatic detection**, the DVR will check whether it's maintenance reboot while power on. If so, pass to detect there is new firmware package. (Judgment method: The system current time is 30 minute later than the auto reboot maintenance time setting. )If it's not reboot because maintenance, the detection will be running after 5minute later. While there is new firmware, the upgrade bar will show "There are new firmware available" , the user Click this channel upgrade, it'll download firmware.

(2) Enable **Automatic Detection**, it'll detect whether there are new firmware periodicity.If so, the upgrade page will show "There are new firmware available" , the user Click this channel upgrade, it'll download firmware.The detection cycle is the random time after reboot period time 18~23 hours(including the maintenance, the unit is second).This cycle is from the device power on randomly and won't change this detect cycle until the device power off.

(3) During the system running, the user can Click **Detect** to check whether there is new firmware.After Click, it'll be a box prompt is detecting, after the detection is complete, the status bar display the result.Note: Detect manually won't influence the detection cycle.

(4) **Automatic Detection** ---From turn on to turn off, the detection cycle will stop.

**Automatic Detection** ---From turn off to turn on, the detection cycle will start.The detection cycle is randomly in this time point 18~23hours later.After turning on the button, the detection will start 1 minute delay.Note: If during this minute, the user turn off the menu again, it'll stop counting and won't detection any more until turn on this function again.

**Note:** The neutral program does not currently support FTP online upgrades

### 5.7.3.5 Parameter Management

You can *export* the main menu settings you have configured to a USB flash drive, or import an exported setting file from USB flash drive to the DVR.

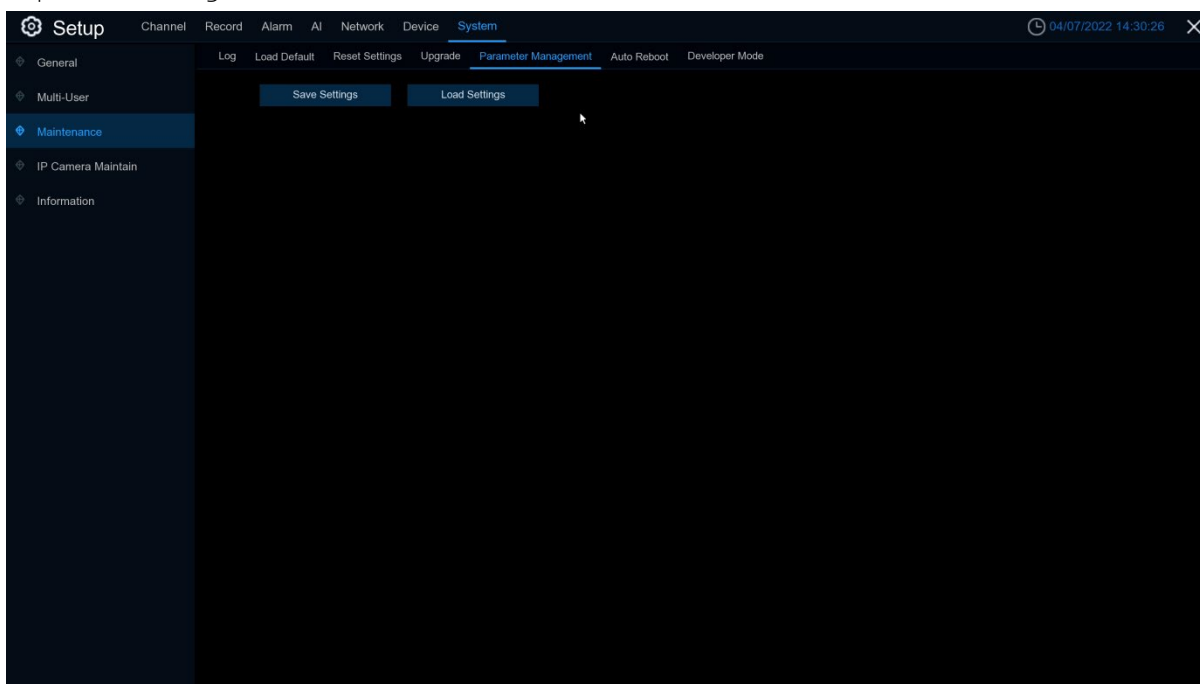

**Save Settings:** Click to save the DVR current system settings to the USB device. You will be required to input the Admin password to authenticate.

**Load Settings:** Once you have created a system settings export, you can import the settings on another DVR. Click **Load Settings** button to navigate to the system settings file you want to import from your USB flash driver. You will be required to input the Admin password to authenticate.

### 5.7.3.5 Maintenance

This menu allows the system to auto reboot the DVR regularly. It is recommended to leave this function enabled, as it maintains the operational integrity of your DVR.

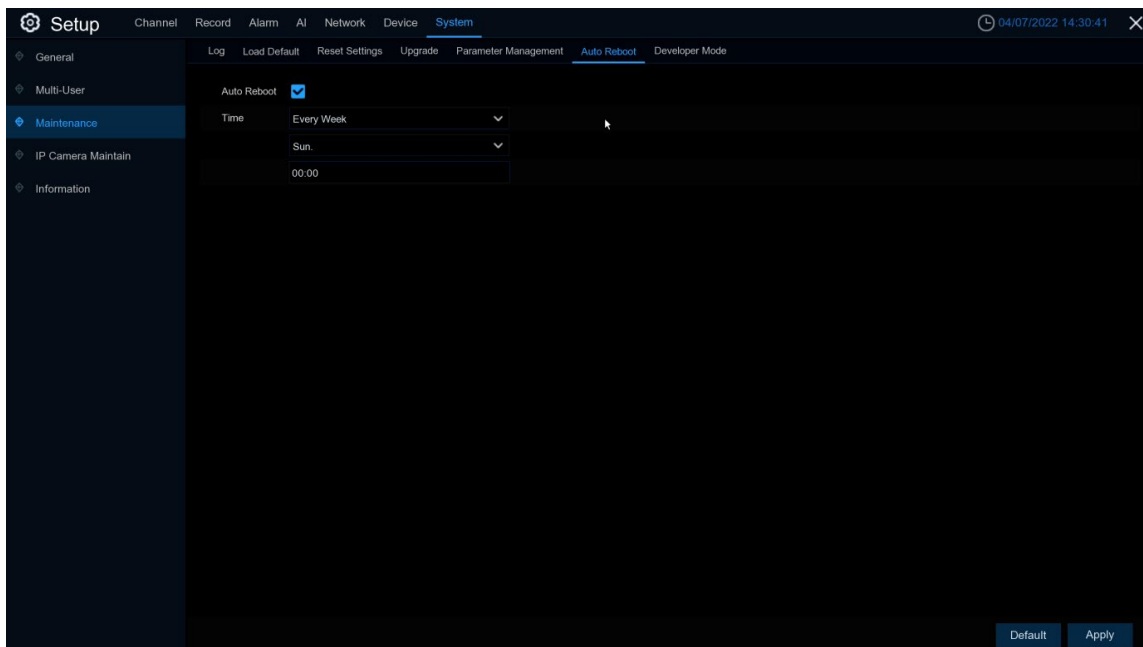

**Auto Reboot:** Click to enable this function.

**Time:** You can set the DVR to reboot by day, week or month.

### 5.7.3.6 Developer Mode

Only some devices support. This menu can save the serial port log to the USB flash disk.

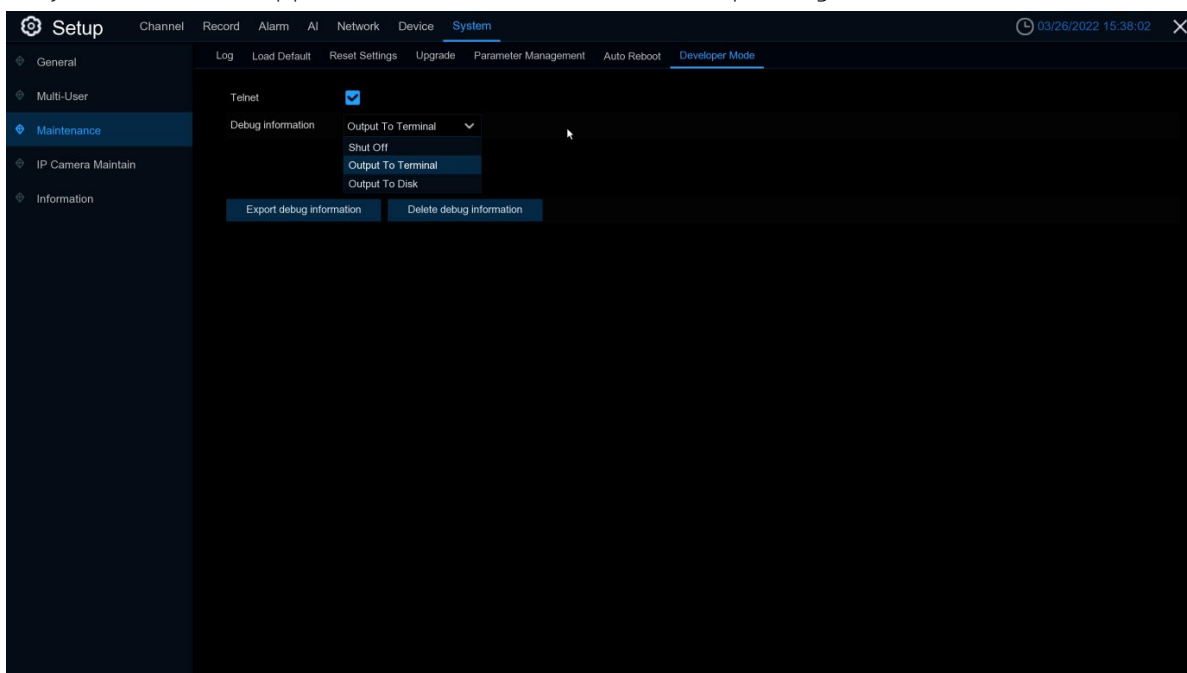



**Telnet:** Enable this menu can use Telnet to login device.

**Debug information:** Select log save position

**Shut Off:** Don't save serial logs

**Output To Terminal:** Output serial logs to terminal

**Output To Disk:** Save serial logs to HDD.

**Export debug information:** Export serial logs to u disk drive.

**Delete debug information:** Delete collect serial logs.

## 5.7.4 IP Camera Maintain

This menu allows you to upgrade the IP camera's firmware and restore default settings of IP camera.

### 5.7.4.1 Upgrade IP Camera

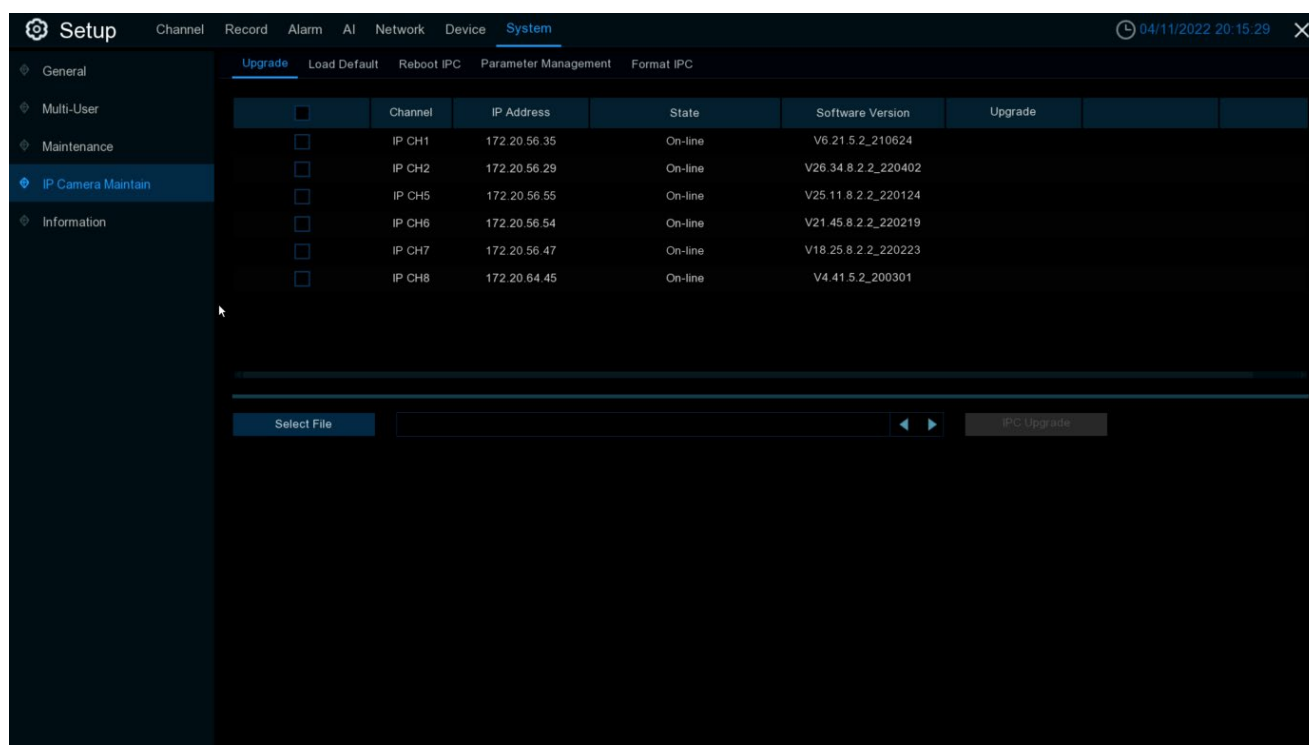

1. Choose one of the IP cameras you want to upgrade firmware
2. Click **Select File** select the update file from your USB flash drive, then click **OK**.
3. Click **IPC Upgrade** button to start upgrading. You will be required to input the Admin password to authenticate. Please **DO NOT** power off the DVR and IP camera or remove the USB during the upgrading.

**Auto Upgrade:** Some IPC supports upgrading using the upgrade package in FTP. You only need to open FTP in the IE menu of IPC. Then upload the upgrade package to upgrade IPC FTP on DVR. Select **enable / disable** to enable or disable the feature.

**Automatic Detection:** Automatically detect upgrades. Check whether there is the latest upgrade package in the FTP server at regular intervals and when starting up. If yes, you will be prompted whether to upgrade please view [5.7.3.4.2 Onlie Upgrade](#)).If yes, you will be prompted whether to upgrade

**Enable/Disable** this function.

**Detect:** Manually check for the latest upgrade package.

**Upgrade:** If the latest upgrade package is detected, click to upgrade.

### 5.7.4.2 Load Default Settings for IP Camera

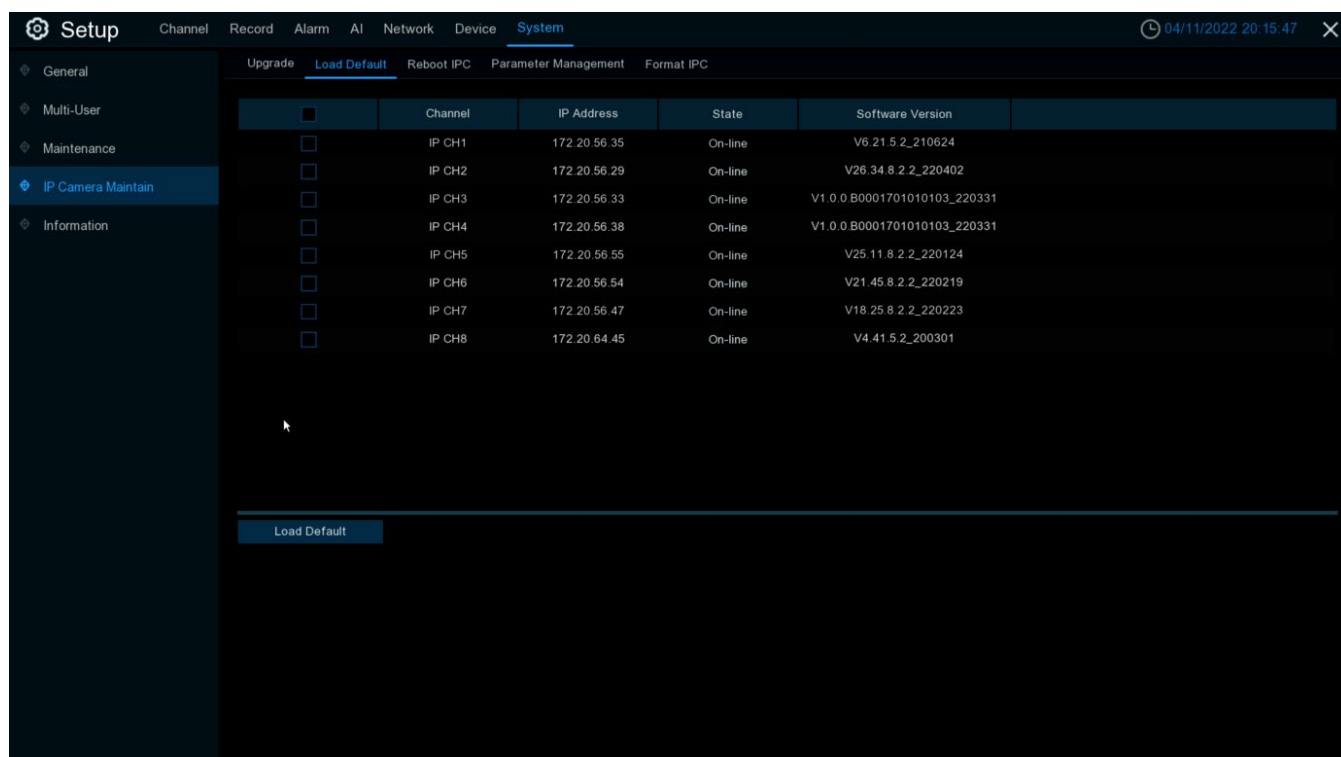

1. Choose the IP cameras you want to restore.
2. Click **Load Default** to restore settings. You will be required to input the Admin password to authenticate.

### 5.7.4.3 Reboot IPC

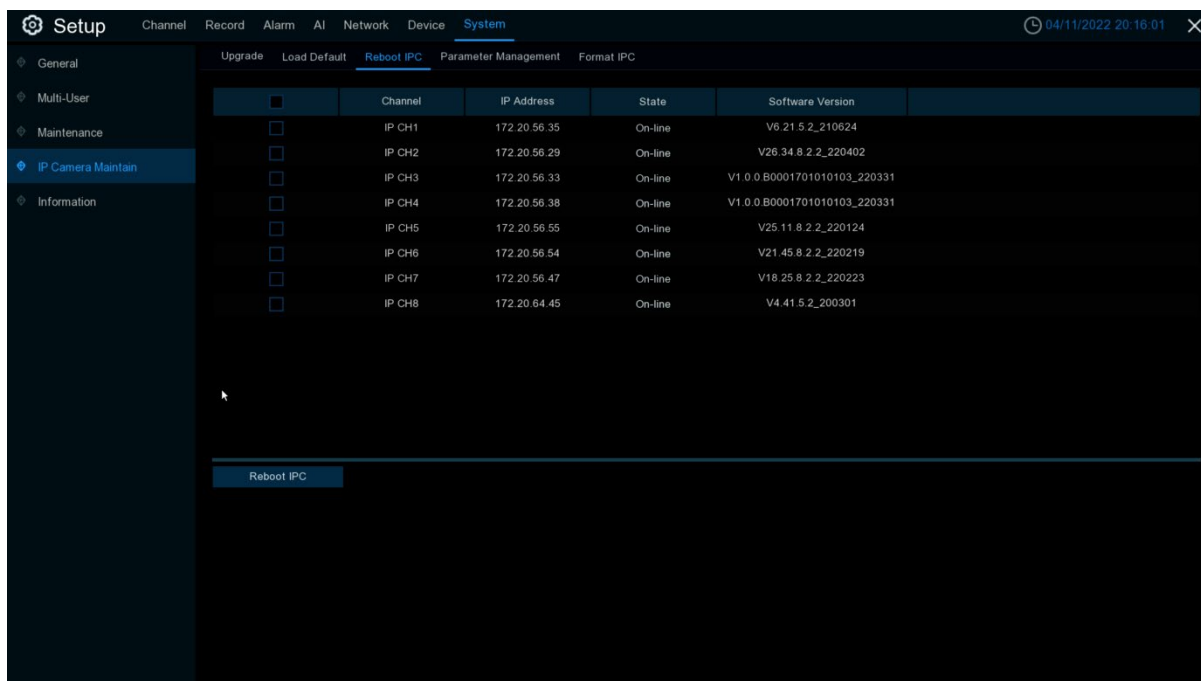

You can restart IPC in this menu. Check IPC and click [reboot IPC](#).

### 5.7.4.4 Manage IPC parameters

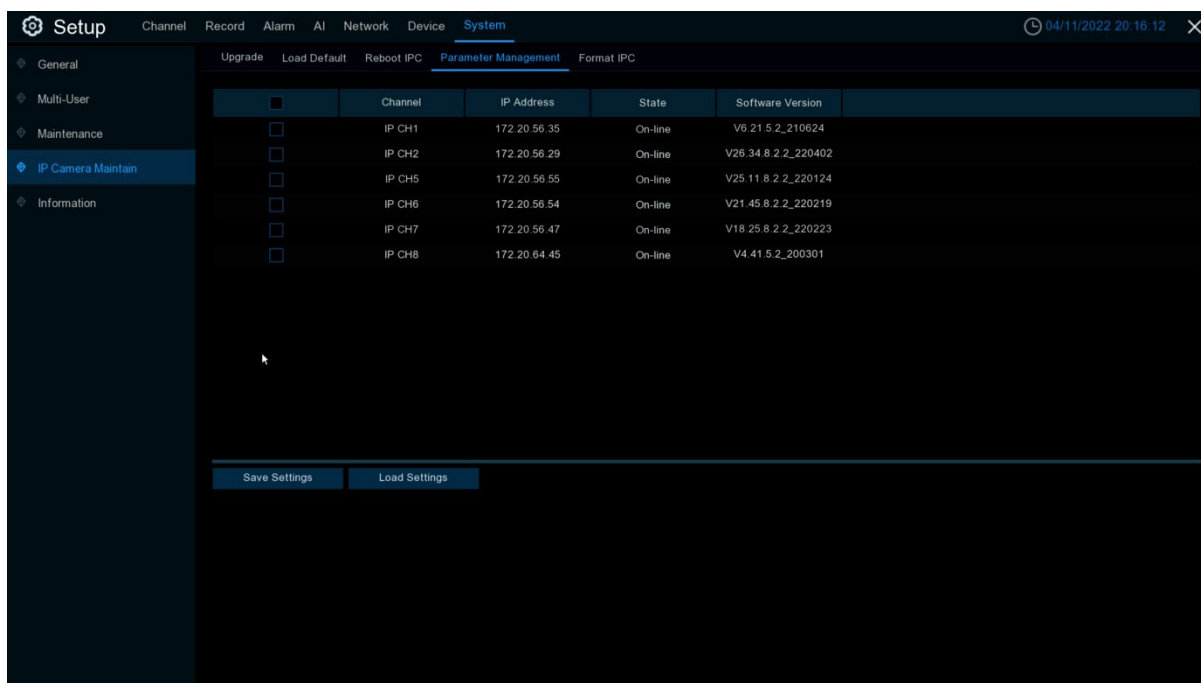

Export parameters, check IPC, click Save settings, and the USB flash disk path will pop up. After selecting the path, click OK to export IPC to USB flash disk. Check IPC and click load settings to import parameter files from USB flash disk into the IPC.

## 5.7.4.5 Format IPC

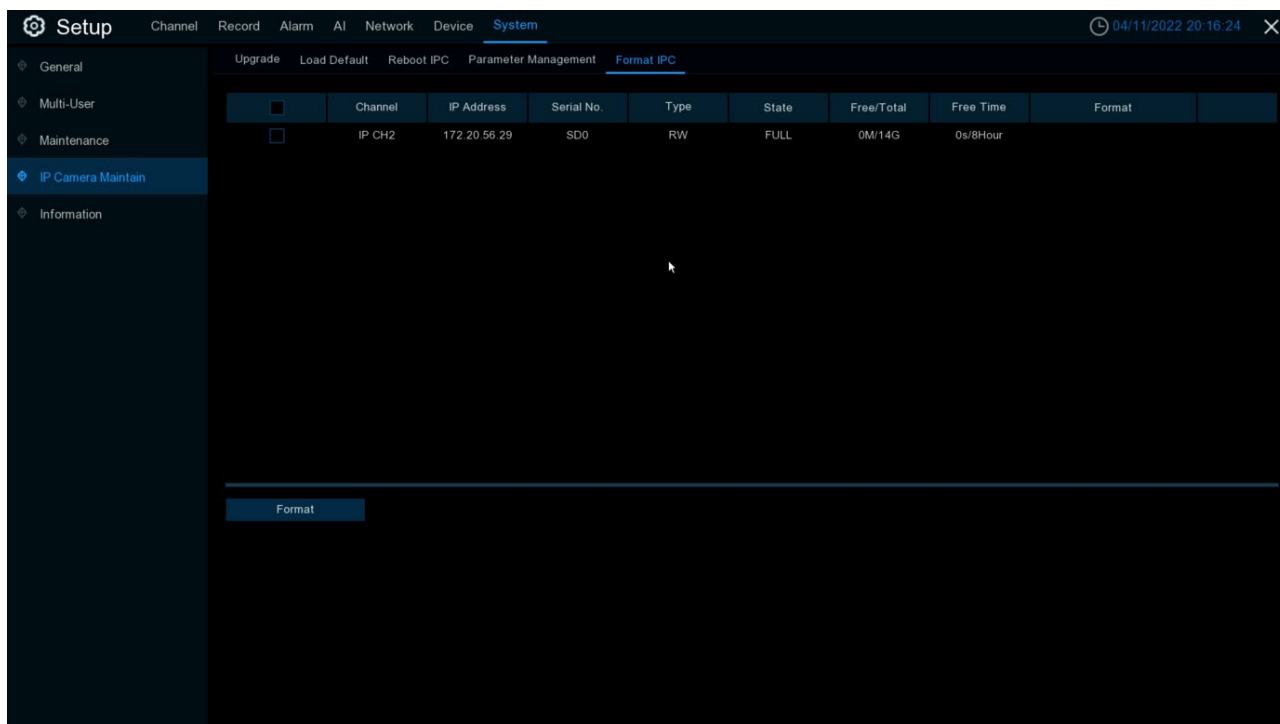

This function can detect SD memory card connected to an IPC with the API protocol, and click Format's SD card for the IPC that can be formatted.

**Note:** DVR and IP camera need version 8.2.2 and above.

## 5.7.5 System Information

This menu allows you to view the system information, channel information, record information & network status.

### 5.7.5.1 Information

View system information such as device ID, device model name, IP address, MAC address, firmware version and more.

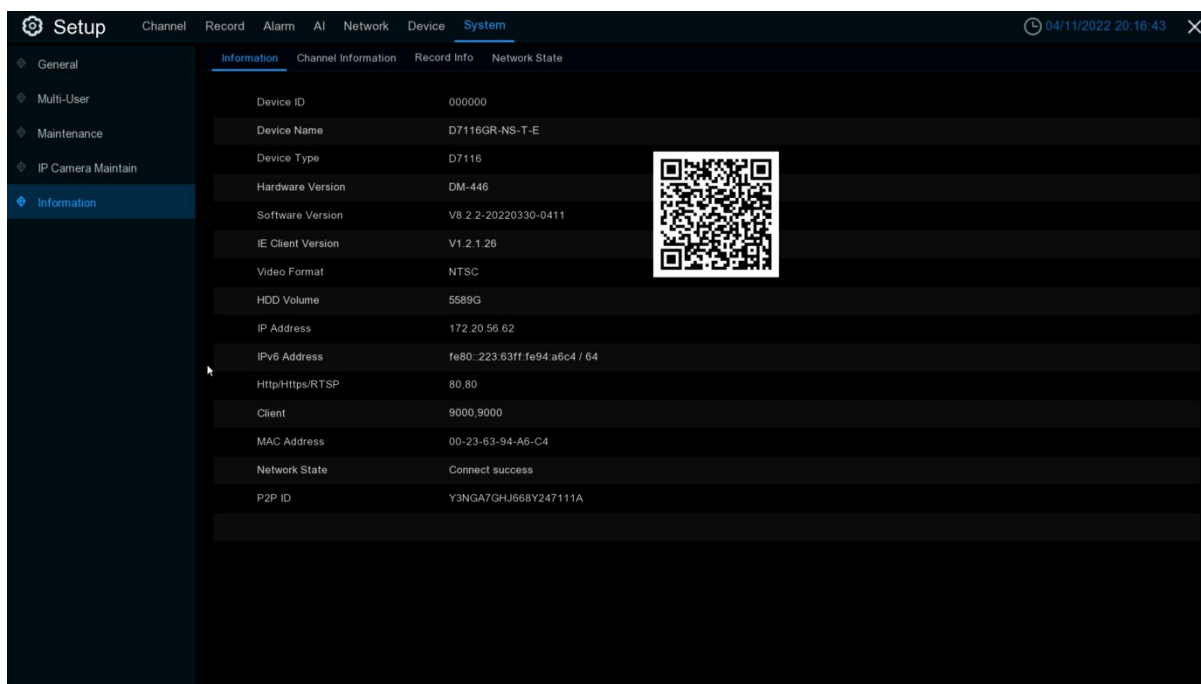

If your DVR supports P2P function, you will find the P2P ID & P2P QR code in the information page. You can scan this QR cord with mobile app to remote view the DVR.

### 5.7.5.2 Channel Information

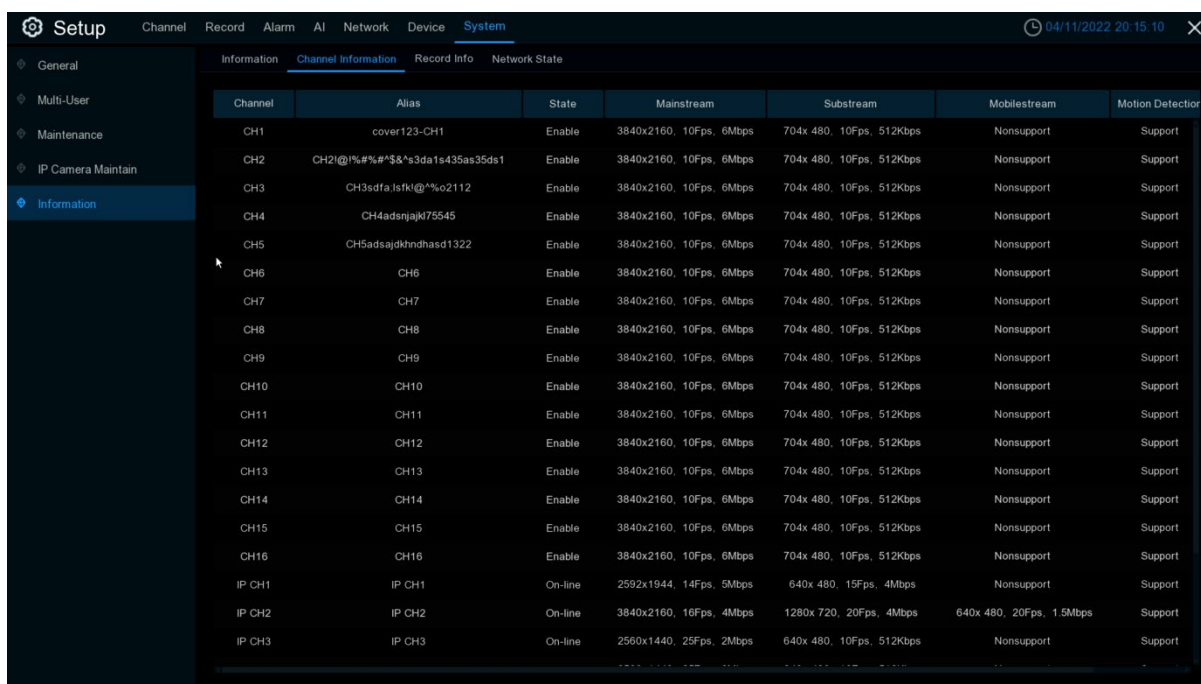

View channel information for each connected camera such as alias, mainstream and substream recording specifications, motion detection status & privacy zone.

### 5.7.5.3 Record Information

Channel	Record State	Record Switch	Stream Type	Resolution	FPS	Bitrate
CH1	ON	Enable	DualStream	3840x2160   704x480	10Fps   10Fps	6Mbps   512Kbps
CH2	ON	Enable	DualStream	3840x2160   704x480	10Fps   10Fps	6Mbps   512Kbps
CH3	ON	Enable	DualStream	3840x2160   704x480	10Fps   10Fps	6Mbps   512Kbps
CH4	ON	Enable	DualStream	3840x2160   704x480	10Fps   10Fps	6Mbps   512Kbps
CH5	ON	Enable	DualStream	3840x2160   704x480	10Fps   10Fps	6Mbps   512Kbps
CH6	ON	Enable	DualStream	3840x2160   704x480	10Fps   10Fps	6Mbps   512Kbps
CH7	ON	Enable	DualStream	3840x2160   704x480	10Fps   10Fps	6Mbps   512Kbps
CH8	ON	Enable	DualStream	3840x2160   704x480	10Fps   10Fps	6Mbps   512Kbps
CH9	ON	Enable	DualStream	3840x2160   704x480	10Fps   10Fps	6Mbps   512Kbps
CH10	ON	Enable	DualStream	3840x2160   704x480	10Fps   10Fps	6Mbps   512Kbps
CH11	ON	Enable	DualStream	3840x2160   704x480	10Fps   10Fps	6Mbps   512Kbps
CH12	ON	Enable	DualStream	3840x2160   704x480	10Fps   10Fps	6Mbps   512Kbps
CH13	ON	Enable	DualStream	3840x2160   704x480	10Fps   10Fps	6Mbps   512Kbps
CH14	ON	Enable	DualStream	3840x2160   704x480	10Fps   10Fps	6Mbps   512Kbps
CH15	ON	Enable	DualStream	3840x2160   704x480	10Fps   10Fps	6Mbps   512Kbps
CH16	ON	Enable	DualStream	3840x2160   704x480	10Fps   10Fps	6Mbps   512Kbps
IP CH1	ON	Enable	DualStream	2592x1944   640x480	14Fps   15Fps	5Mbps   4Mbps
IP CH2	ON	Enable	DualStream	3840x2160   1280x720	16Fps   20Fps	4Mbps   4Mbps
IP CH3	ON	Enable	DualStream	2560x1440   640x480	25Fps   10Fps	2Mbps   512Kbps
IP CH4	ON	Enable	DualStream	2560x1440   640x480	25Fps   10Fps	2Mbps   512Kbps

View recording *information* for each connected camera such as bitrate, stream type, recording resolution and frame rate (FPS).

### 5.7.5.4 Network State

Attribute	Value
WAN	
IP Address	172.20.56.62
Subnet Mask	255.255.255.0
Gateway	172.20.56.1
MAC Address	00-23-63-94-A6-C4
IPv6 Address	fe80::223:63ff:fe94:a6c4 / 64
IPv6 Gateway	fe80::/64
DHCP	Enable
DNS1	172.18.1.222
DNS2	8.8.8.8
PPPoE	Disable
Port	
Http/Https/RTSP	80,80_Inactive_Disable
Client	9000,9000_Inactive_Disable
Total Band Width:	128Mbps
Used Band Width:	55.5Mbps

View network *information*.

**Total Band Width:** It shows the DVR's total input band width for IP cameras.

**Used Band Width:** It shows the used band width of IP cameras.

# Chapter 6 AI Scenario

AI scenario application function you real real view of the face attendance, more intuitive and convenient to view the real situation.

## 6.1 Face attendance

Face attendance screen, which can record face attendance in real time and check the attendance results in real time.



1. Interface theme of face attendance.

2. Click  to enter the playback face attendance search interface, and select the face pictures in the face group by default.

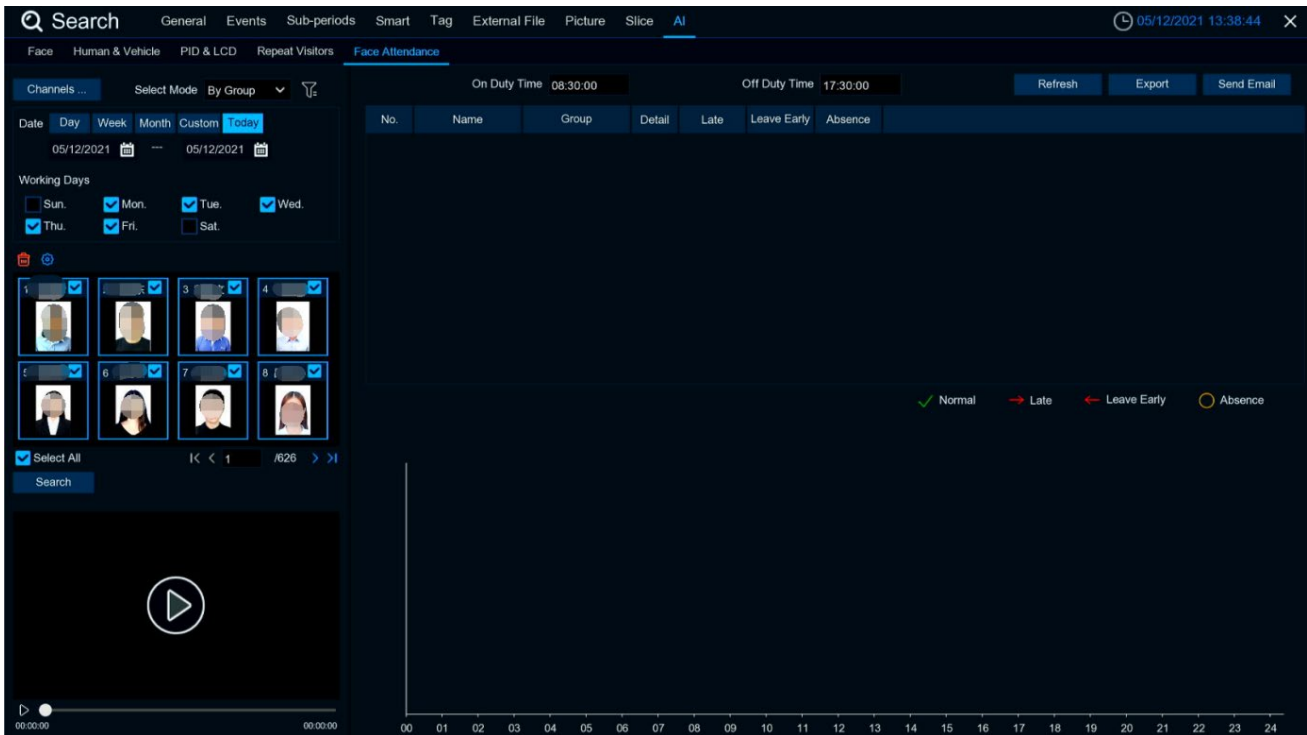

3. Click  to enter the setup interface.

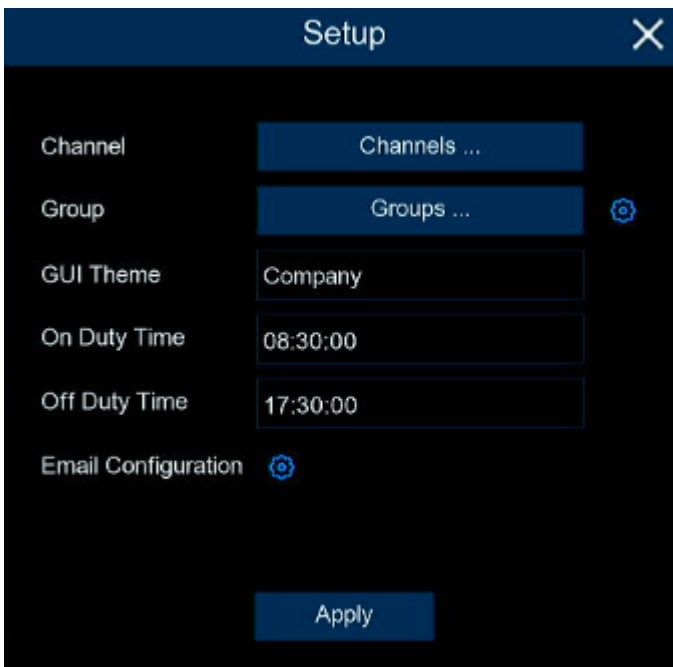

Channels: Channel selection



**Groups:** Select the faces of those face database for attendance, and click  to pop up to the AI face database Settings interface.



**GUI Theme:** Main interface diagram

**On Duty Time:** Set up the duty time

**Off Duty Time:** Set up the off duty time

**Email Configuration:** Send face email configuration, click  to send face attendance result email configuration.

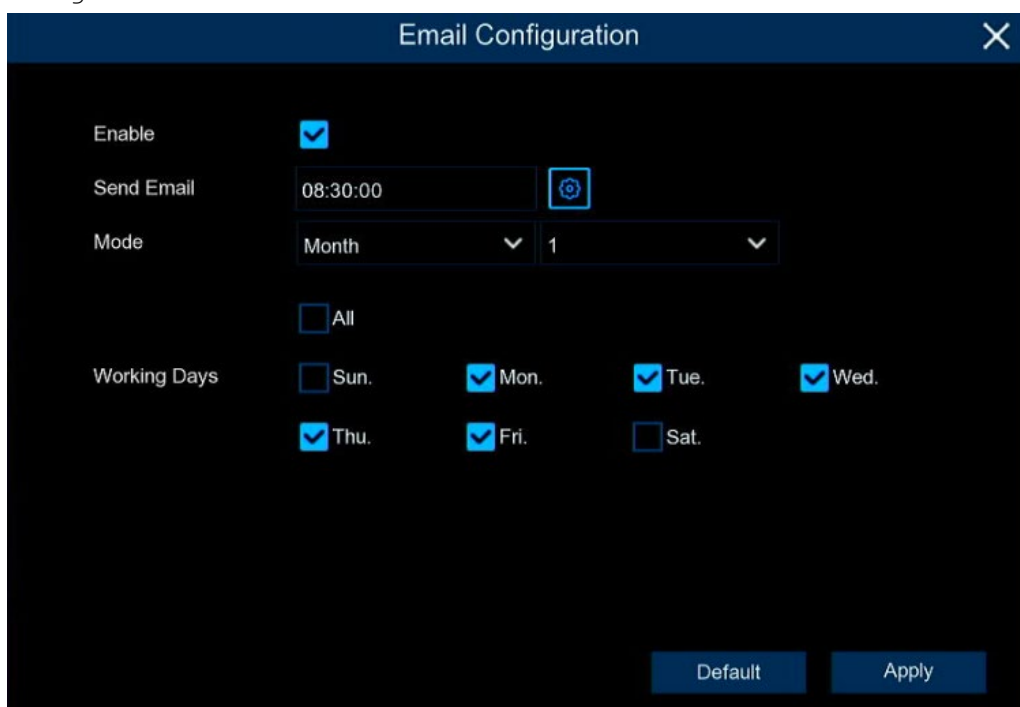

**Enable:** Enable email to send face attendance results (the attendance result is a form file)

**Send Email:** Set the time of sending the face attendance result email, click the pop-up system email setting interface on the right side  to configure the system email, Please view [5.5.3.1 Email Configuration](#)

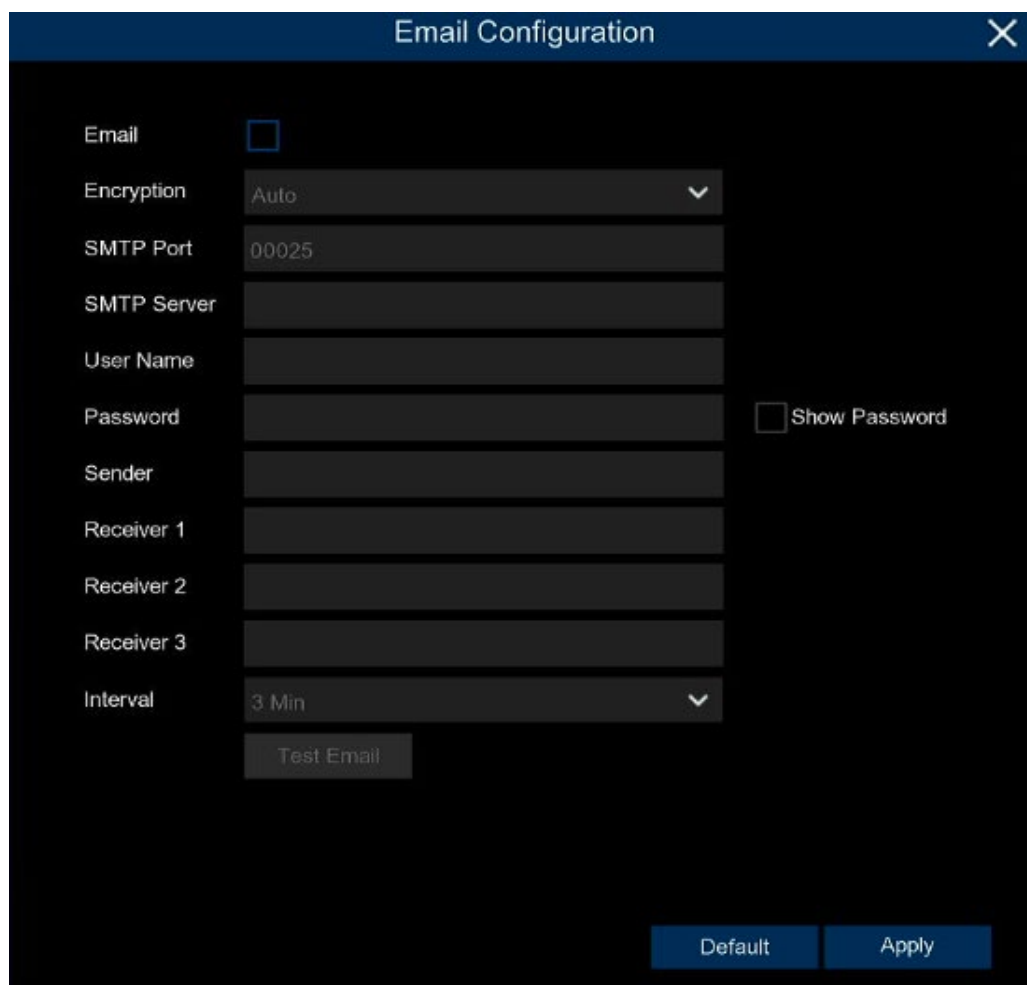

**Mode:** The mode of sending face attendance results, Day, Week and Month

**Day:** Send it once a day, and send you yesterday's face attendance results.



**Week:** send once a week, you can choose the week to send sent face attendance results for the email time forward a week. For example:

When an email is sent on Monday, the attendance record is sent on last Monday and last Sunday.

When sending an email on Tuesday, the attendance record is last Tuesday to Monday.



**Month:** Send once a month, you can choose the day of each month to send the sent face attendance results for sending the email time pushed one month forward. For example:

When an email is sent on the 10th of each month, the attendance record is sent from the 10th of last month to the 9th of this month.

if the email is sent on May 10th, the attendance record sent is the attendance record from April 10th to May 9th.

**Working Days:** Select a working day, check **All**, every day is a weekday

**Apply:** Click Apply to save the settings

**Default:** Send attendance Mail Settings Recovery default

4. Displays the current date and time

5. Current total number of people attendance situation



Total number of attendance attendance required



Number of attendance



No attendance



6. The attendance status of each face group

7. Channel has image, selected  **Channels** to choose channel

8. Select the number of graph windows, single windows , two windows , four windows



9. Face real-time attendance push, display attendance face picture, name, from the group name, work attendance time and off-work attendance time.

10. The interface also displays the maximum number of face attendance pushes, with 1 , 6 

12 

## 6.2 Cross Counting

This is an AI application based on cross-count functions that helps control the attendance of customers / visitors / vehicles in public places such as restaurants, parks, zoos, theaters, museums, and parking lots.

### 6.2.1 Channel

Count and view real-time results through a single camera. Mainly used for small places with single entrances and exits.

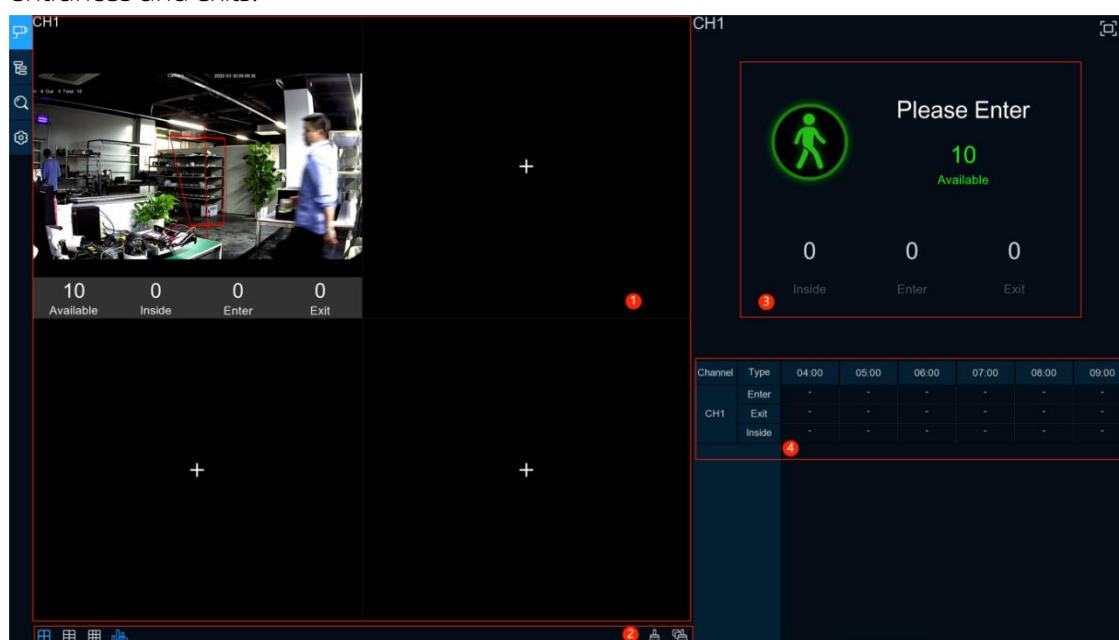

1.Channel drawing and real-time line crossing statistical data, the drawing  channel can be selected in [Channels](#).





**Available:** Number of remaining allowed

**Inside:** Current existing quantity in the control area

**Enter:** Number of recorded entries

**Exit:** Number of departures recorded

2.Select the number of drawing windows, four windows  , six windows  , nine windows  .

Click  display / hide the statistics under the channel. Click  to clear the current selected channel statistics, , click  to clear all the channel statistics.

3.Real-time count data information, click  to display the total statistics on the full screen.

4.Data and exit information of each channel in each time period.

## 6.2.2 Group

Statistics and view real-time results by group. It is mainly used in large places with multi-channel entrances and is monitored by multi-channel cameras.

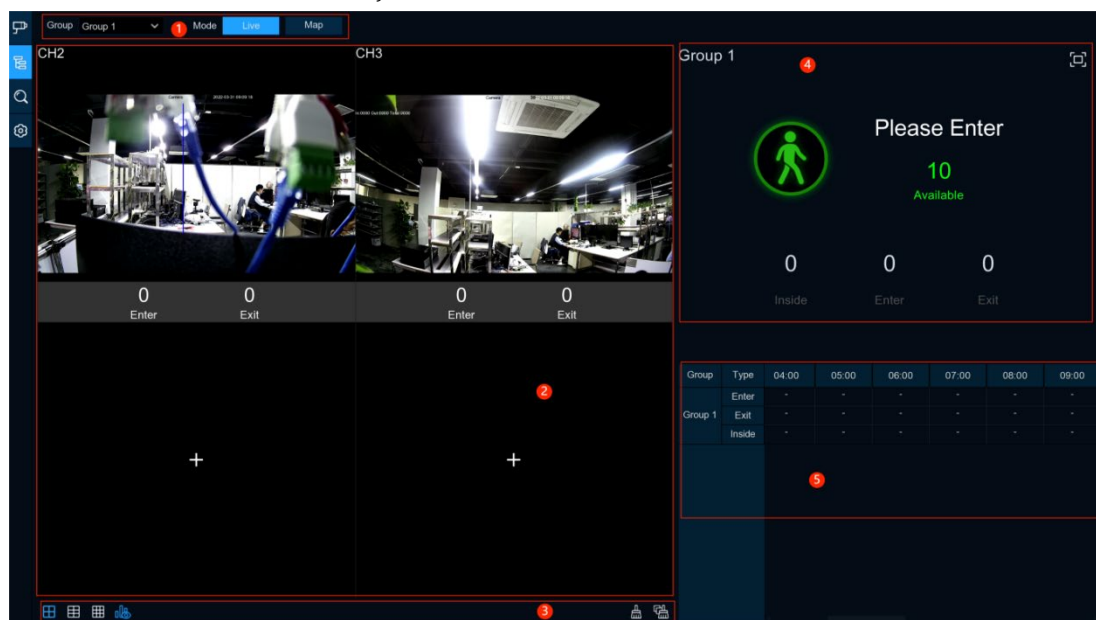

1. Group can select the displayed group information displayed, Live displays the channel preview screen and statistics, and Map shows the map information.



2. Channel drawing and real-time line crossing statistical data, select in  Group to select each group drawing channel.



Enter: Number of recorded entries

Exit: Number of departures recorded

3. Select the number of drawing windows, four windows  , six windows  , nine windows  .

Click  display / hide the statistics under the channel. Click  to clear the current selected channel statistics, , click  to clear all the channel statistics.



4. Real-time count data information, click  to display the total statistics on the full screen.

Available: Number of remaining allowed

Inside: Current existing quantity in the control area

5. Data and entry and exit information of each group and each time period.

(Graph 2)

6. Map information configuration, click  to add a map picture, click  to set the position of the IPC schematic map on the map, click  to display the map information and the Cross -Counting statistics of the current group in the full screen

### 6.2.3 Search



Search for channels and groups separately. Select the channel or group that you want to search for, set the search duration by day, week, month, or year, and select the type of target that you want to search for. Click the search icon and the results appear on the right side of the window.

### 6.2.4 Setup

#### Configuration Settings

Image Configuration

Advertise Mode  Keep Aspect Ratio

SEQ Dwell Time 3 Image 

Describe: Set the advertising picture, whether the advertising picture is stretched or not, and the advertising polling time

**Channel** 

Channel	Enable	Capacity	Setup	Alarm
IP CH1	<input type="checkbox"/>	10		
IP CH2	<input type="checkbox"/>	10		
IP CH3	<input type="checkbox"/>	10		
IP CH4	<input type="checkbox"/>	10		
IP CH5	<input type="checkbox"/>	10		
IP CH6	<input type="checkbox"/>	10		
IP CH7	<input type="checkbox"/>	10		
IP CH8	<input checked="" type="checkbox"/>	10		

**Group** 

Group	Add IP Camera	Enable	Capacity	Start Time	End Time	Type	Alarm
Group 1		<input type="checkbox"/>	10	00:00:00	23:59:59	Person	
Group 2		<input type="checkbox"/>	10	00:00:00	23:59:59	Person	
Group 3		<input type="checkbox"/>	10	00:00:00	23:59:59	Person	
Group 4		<input type="checkbox"/>	10	00:00:00	23:59:59	Person	
Group 5		<input type="checkbox"/>	10	00:00:00	23:59:59	Person	
Group 6		<input type="checkbox"/>	10	00:00:00	23:59:59	Person	
Group 7		<input type="checkbox"/>	10	00:00:00	23:59:59	Person	
Group 8		<input type="checkbox"/>	10	00:00:00	23:59:59	Person	



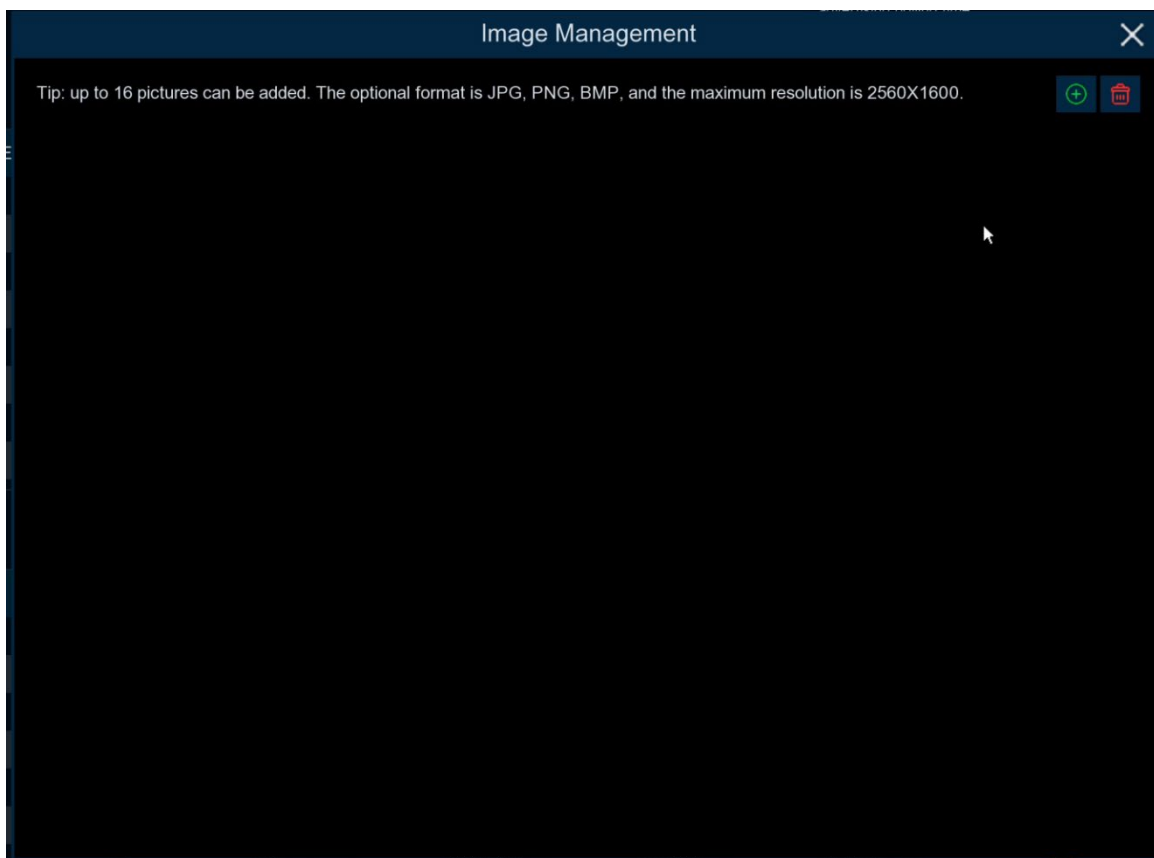

Apply

1. Check **Advertise mode** for AD mode. set the SEQ residence time in seconds, which determines the time that each image stays on the screen, by default to 3 seconds. Click **Image** to load ad pictures from USB memory and supports the addition of up to 16 images in jpg, png and bmp format, picture resolution can't over 2560x1600.



Click  add new picture, click  delete added picture one by one.

Check **Keep Aspect Ratio** box if you want to display an image with the original aspect ratio, or unchecked the box if you want the image to stretch out and appear in the full screen. Return to Channel View Mode or Group View Mode, and click the full-screen button in the upper right corner to display your ad image and the real-time count data for the selected channel or group.

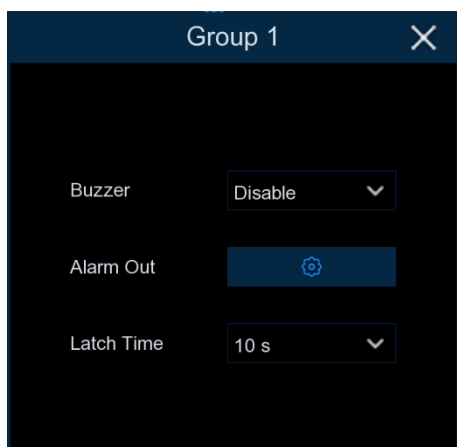

2. Set **Enable** selects which channels to display on the channel page. If the camera in the channel supports AI functionality, **Setup** and **Alarm** icons will be blue . Instead, if the camera does not support AI functionality, the icon will be gray . Set up **Capacity** which is the maximum limit for attendance. Click **Setup**  to configure the detection condition. Click **Alarm**  to enter Trigger when the number is 0.



**Buzzer:** Set the buzzer duration in seconds when the available number is 0.

**Alarm Out:** If your DVR supports a connection to an external alarm device, you can set it to sound an alarm.

**Latch Time:** Configure the external alarm time with the available number of 0.

3. Click the Add IP Camera  icon to add the channel to the group. Up to eight groups can be set, but can only be added to one group per channel. If channels are enabled in channel view mode, they are not allowed to add to any group. Select the Enable box to activate the group. You can set the number of **Capacity**, **Start Time**, **End Time**, detection type ( **Person**, **Vehicle** and **Motion** ) . Click **Alarm**  to enter configuration page when the number is 0.

## 6.3 Object Classification

Face, Human, Motor Vehicle, NON-Motor Vehicle detection scene interface display full screen, it can **view detection results real time**.

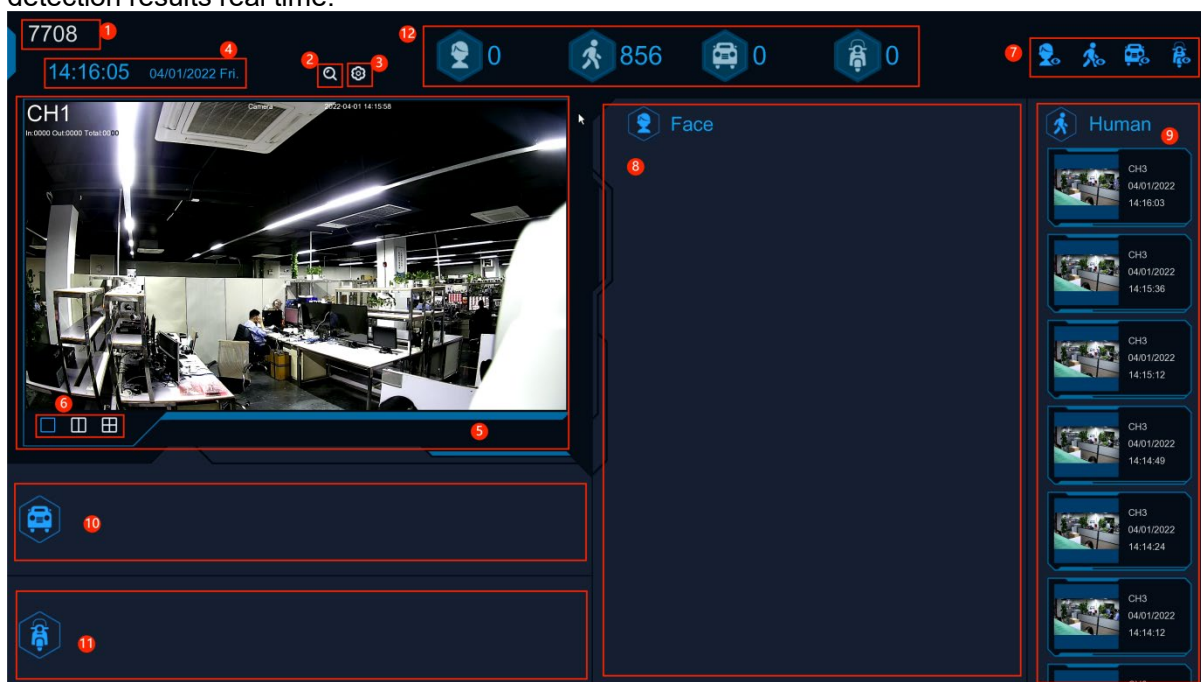



1. Interface theme of machine and non-human statistics

2. Click  to enter playback human&Vehicle search interface.

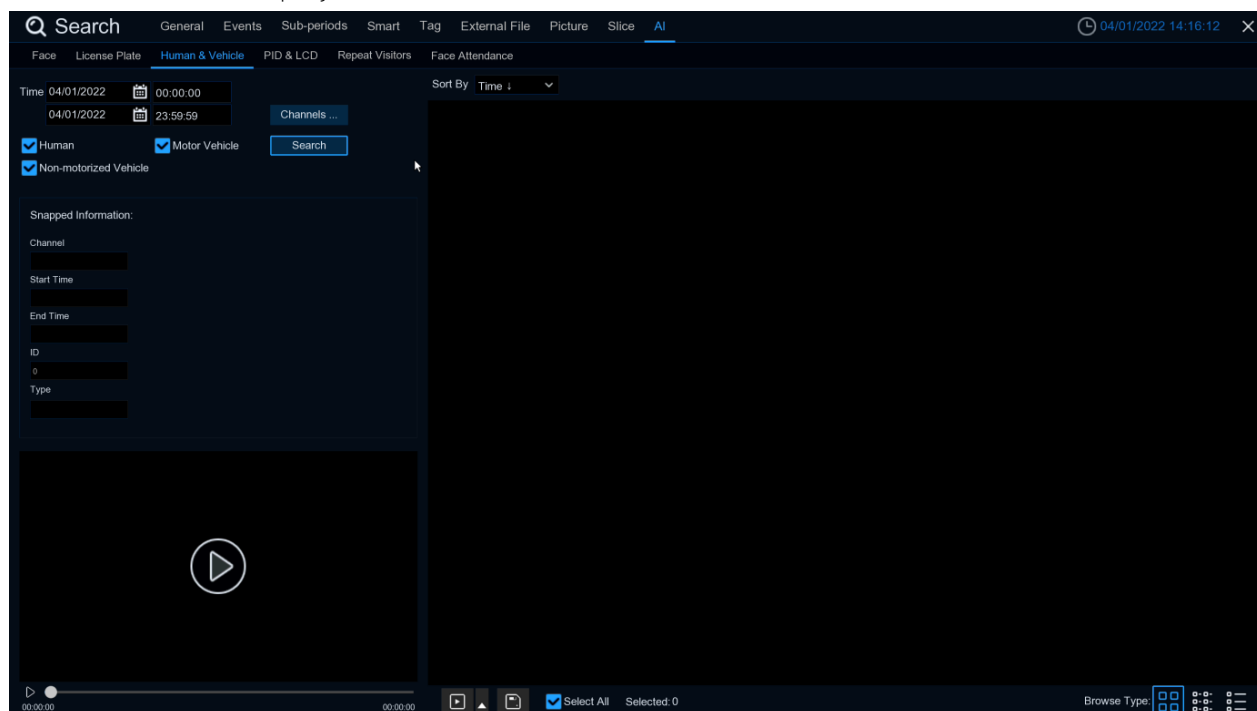

3. Click  to enter setup page.

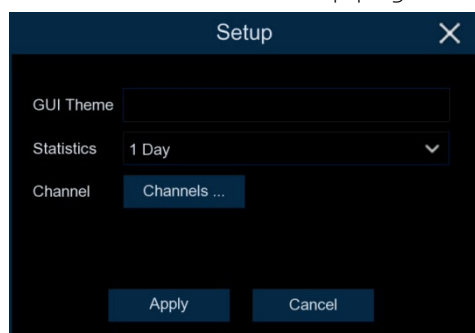

**GUI Theme:** Local Theme

**Statistics:** Statistical time, you can choose 1 day, 2 days, 3 days, 4 days, 5 days, 6 days, 7 days, week, month and year.

**Channels:** Channel selection, you can select the statistical channels.

4. Show the current date and time

5. Channel diagram, In  **Channels** select the channels

6. Select the number of drawing Windows, one window , two windows  four windows .

7. Real-time push display switch, click the icon to display / hide the corresponding detection results of real-time push

8. Real-time push of face detection, and display of the detected face picture, name and source group name.
9. Real-time push of humanoid detection, showing the detected humanoid pictures, detection channels and detection time
10. Real-time push of motor vehicle type detection, showing the detected motor vehicle pictures, detection channels and detection time
11. Real-time push of non-motor vehicle testing, display the detected non-motor vehicle pictures, detection channels and detection time
12. Statistics of the number of human faces, human shapes, vehicle models and non-motor vehicles captured.

## Chapter 7 Search, Playback & Backup

The Search function gives you the ability to search for and play previously recorded videos as well as snapshots that are stored on your DVR's hard drive. You have the choice of playing video that matches your recording schedule, manual recordings or motion events only. The Backup function gives you the ability to save important events (both video and snapshots) to a USB flash drive.

### 7.1 Using Search Function

Click  **Search** button in the Start Menu to enter search section.

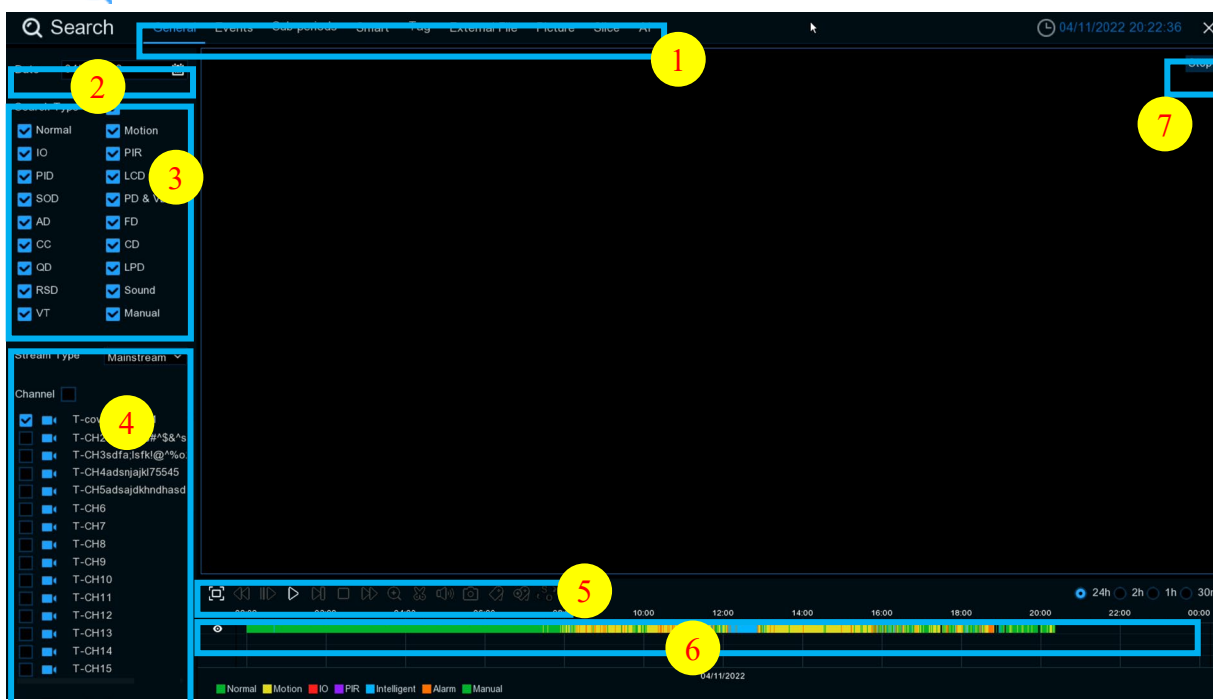

- 1. Search Options:** The system provides various search & playback methods: General, Events, Sub-periods, Smart & Pictures
- 2. Search Date:** Search by a date to play back.
- 3. Search Type:** The system provides different search types to narrow your search.
- 4. Channel Selection:** Choose the channels you want to search & play.
- 5. Video Playback Controls:** Control the video playback.



 Enlarge the video playback to full screen

 Rewind, x2, x4, x8 and x16

 Slow Play, 1/2, 1/4 and 1/8, 1/16 speed

 Play

 Pause

 Play frame by frame. Click once to play a frame of the video

 Stop



 Fast Forward, x2, x4, x8 and x16

 Digital Zoom: Click to zoom in then click -and-drag on a camera image during playback to zoom in on the selected area. Right-Click to return to regular playback.

 Video Clip. Quickly save a section of video to a USB flash drive. View more on [7.1.1.1 Video Clip Backup](#)

 Save Video Clip.

 Volume Control: scroll the slider bar to increase or decrease volume.

 Snapshots: to capture a snapshot image to your USB flash drive. If the video playback is in split-screen view, move the mouse cursor to the channel you want to capture, and then click the  icon to save the snapshot.

 Add default bookmark

 Add custom bookmarks.

 Switch the original proportional screen or stretching screen.

- 6. Timeline:** Continuous recordings are shown with colored bars to represent different types of recording (legend shown in the bottom-right corner of the display). Use the timeframe options () to view a smaller or larger time period.

Different types of recording shown in different colors:



Continuous Recording in **Green** color.

Motion Recording in **Yellow** color.

I/O Recording in **Red** color.

Motion & I/O Recording in **Orange** color.

Intelligent Recording in **Blue** color.





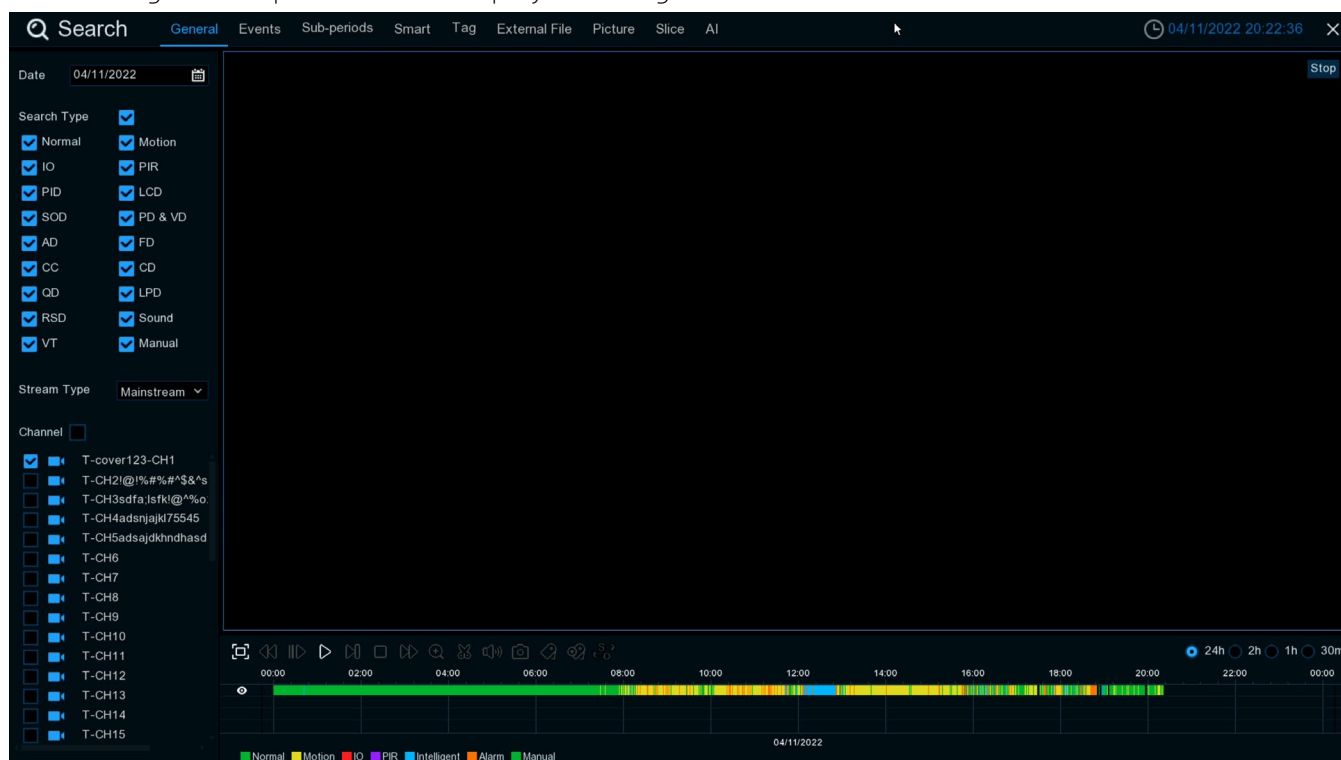

PIR Recording in **Purple** color.

**7. Playback Status:** display the video play status.

## 7.1.1 Search & Play Video in General





This menu gives an option to search & play recording for a selected date.

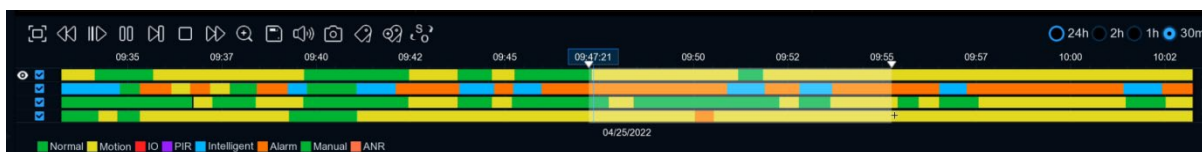

1. Click  icon to search for video recording from the calendar.
2. Choose **Search Type**
3. Check channels you would like to search, or check **Channel**, to search all connected channels.
4. The search result will display on the timeline from 00: 00 to 24: 00.
5. Click  button to start playback.
6. Control the playback with buttons on **Video Playback Controls**.
7. Use the timeframe options () to view a smaller or larger time period.
8. If you want to quickly save a section of video during playing back to a USB flash drive, use the  **Video Clip** backup function.
9. Tag function, click  to add **Costumed Tag**. Click  to add **Default Tag**. You can make a mark at the current time of the current channel. After the addition is completed, you can jump to the previously made "mark" in the label return interface to play back.

### 7.1.1.1 Video Clip Backup



1. Insert your USB flash drive to the DVR.
2. Start a video recording playback.
3. Click  icon.
4. Check the channel(s) you want to make a video clip backup.
5. Move the mouse cursor to the timeline where you want to start the video clip.
6. Press and hold the left button of your mouse, and drag the drag the cursor to the timeline where you want to end the video clip.
7. The  icon has been changed to  icon, click  to save the video clip.
8. Select a file type for your backup files, click **Save** button to save the video clips. Please make sure your USB driver has enough space to save the video clips.

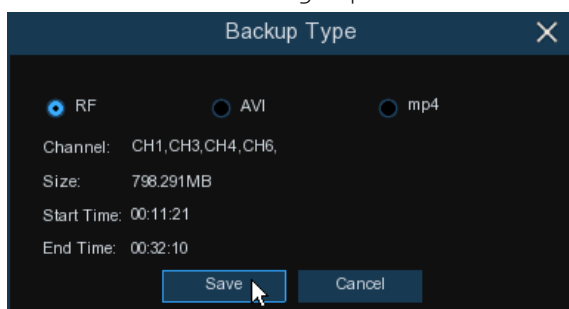

9. The backup drive menu appears. Navigate to the folder you want the backup files to save in.
10. Click **OK** to begin. The progress bar at the bottom of the window shows you the progress of the backup.

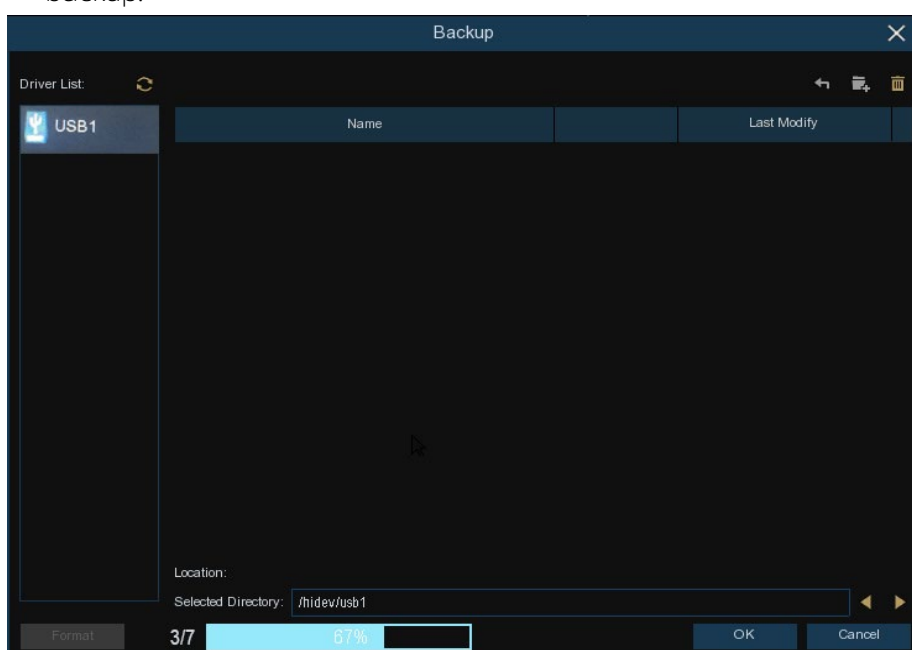

## 7.1.2 Event Search, Playback & Backup

Event search lets you view a list of video recordings with the channel, start and end time, and recording type conveniently summarized. You can also quickly back up events to a USB flash drive.

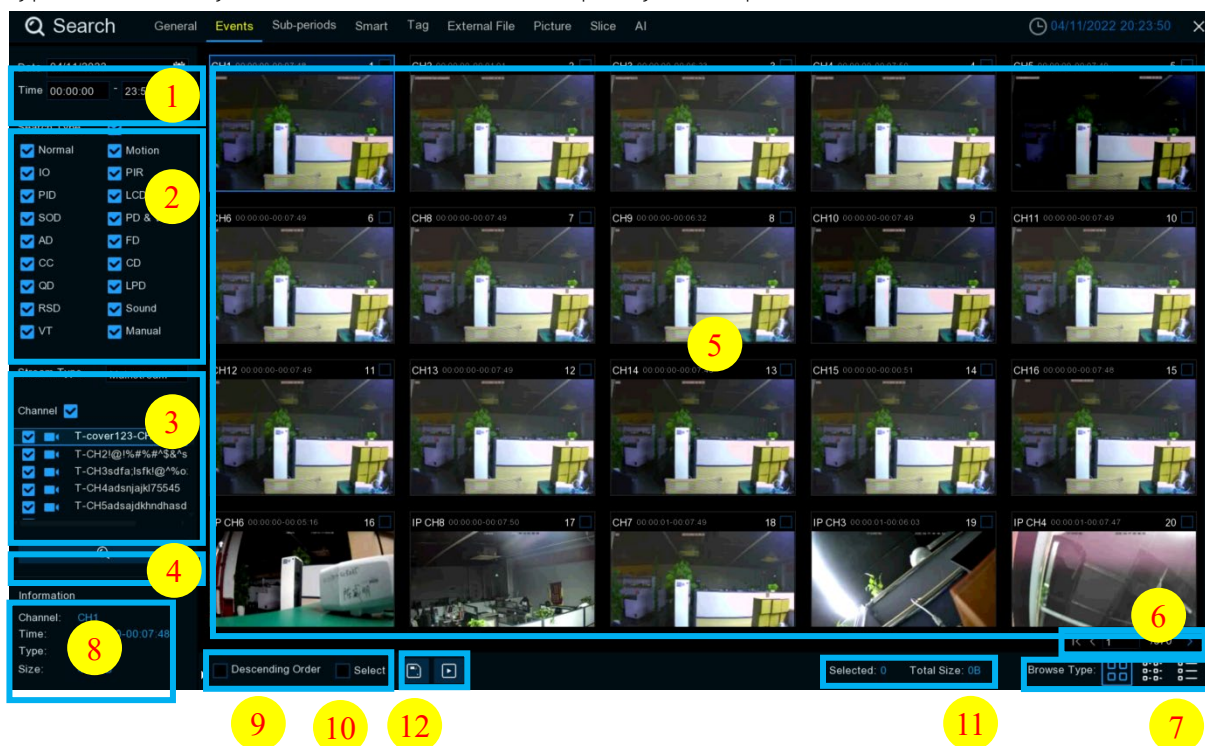

To search, play & back up for events:

1. Choose the date & time you want to search.
2. Check the recording types you want to search, or check **Search Type** to choose all.
3. Choose the channels you want to search, or check **Channel** to choose all channels.
4. Click icon to start search.
5. Events fitting your search criteria are displayed in list form. You can double Click the left button of your mouse upon one of the events to play the video immediately.
6. Click icons in the bottom-right corner of the menu to browse between pages of events, or input the page you want to browse.
7. You can switch the view of list form in by Click below icons which is show at the right bottom corner of the screen:

**Thumbnails view.** You can view the snapshots of the events.

**List view.** The events will be displayed in list.

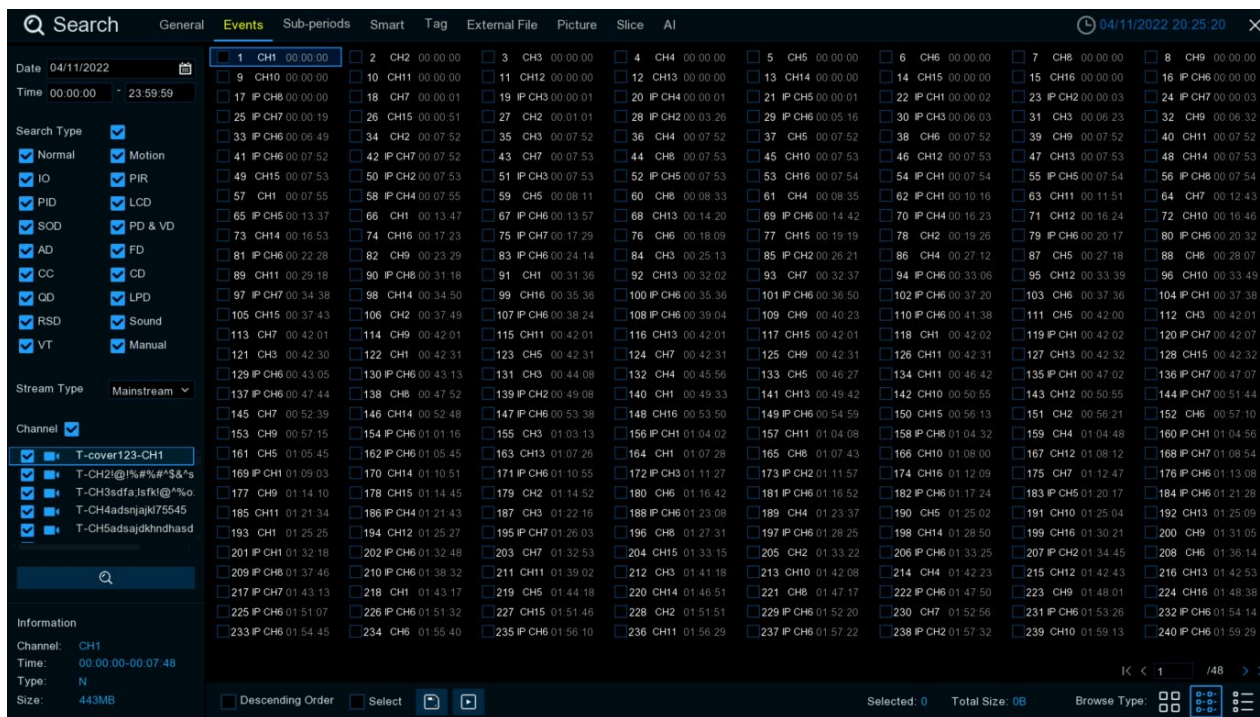

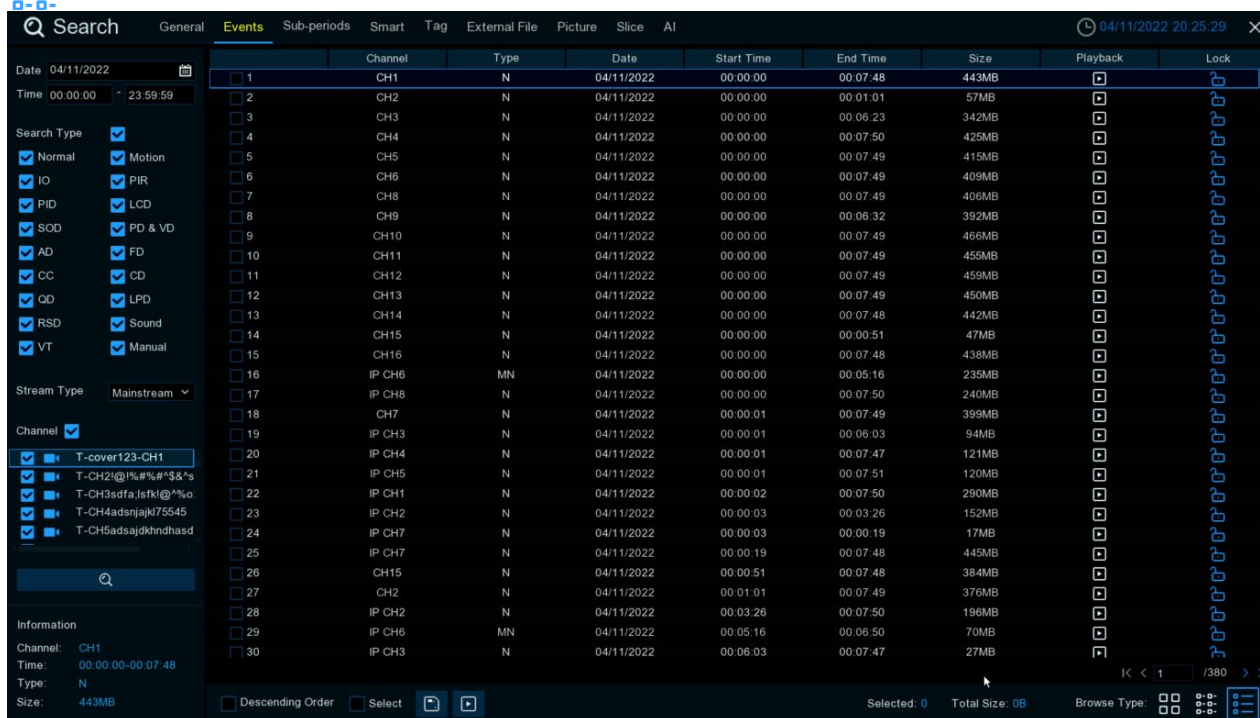

Detailed view. You can view the details of the events.









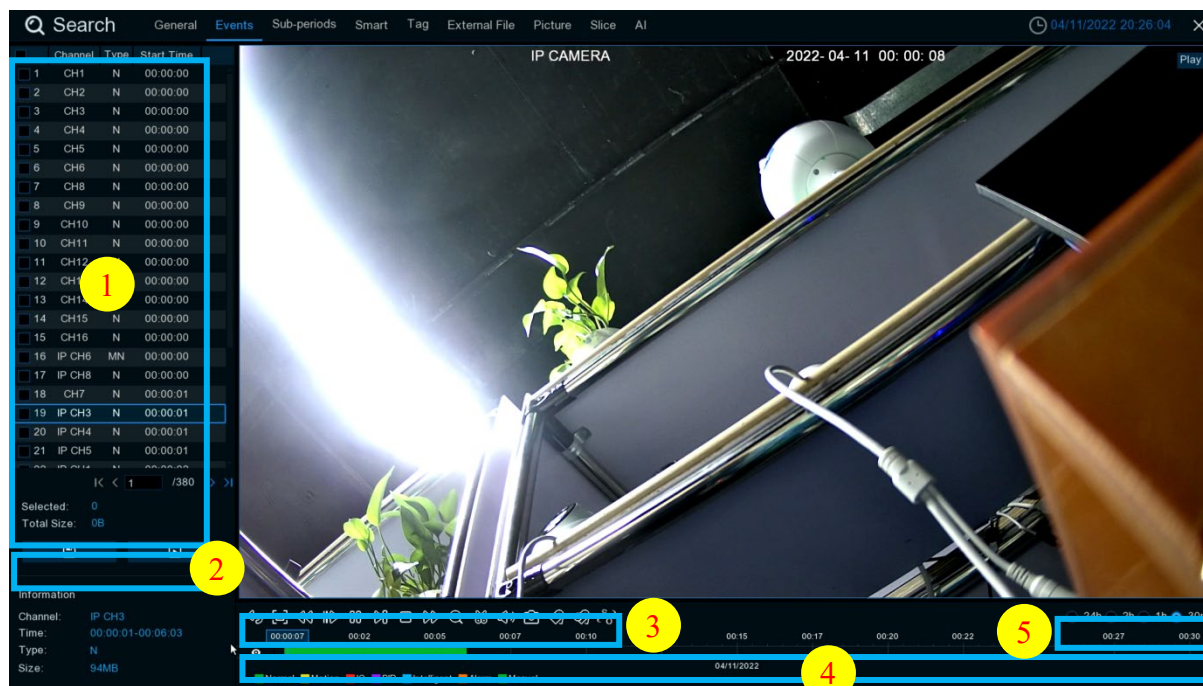

In the detailed view mode, you can lock the video events to keep events from being overwritten in the hard drive. Click the icon to lock or Click to unlock the events.

1. Check the box next to the number of the event to select files, or check the box next **Select** to select all events in the page.
2. The number of selected files, total size information will be displayed at the right bottom of the screen.

3. After selecting file, you can Click  icon to save the video to USB flash drive. Or Click  icon into event playback control window to play the video.

### 7.1.2.1 Event Playback Control



1. Event List, you can select the events here.
2. Click  icon to save your selected event videos to USB flash drive. Click  icon to play video.
3. Control the playback with buttons on [Video Playback Controls](#). You can Click  icon or Click right button of your mouse to exit the playback and return to event search window.
4. The event you are playing now will be displayed on the timeline.
5. Use the timeframe options (     ) to view a smaller or larger time period.

### 7.1.3 Sub-periods Playback

Sub-periods playback allows you to play multiple normal recordings and motion events simultaneously from a single channel. With normal and event recordings, the video is divided evenly depending on the split-screen mode that has been selected. For example, if the video is an hour long and you have selected Split-screens x 4, each split-screen will play for 15 minutes.



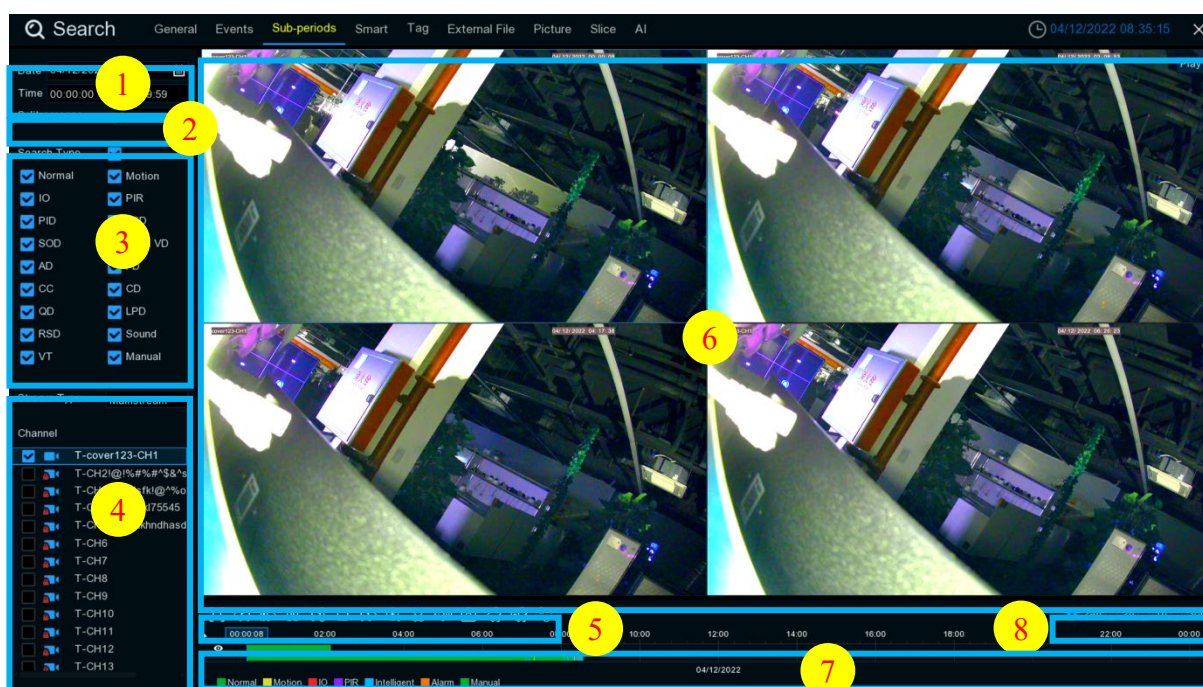



To search & play video in sub-periods:

1. Choose the date & time you want to search.
2. Choose the split-screens you want the videos to be played in.
3. Check the recording types you want to search, or check **Search Type** to choose all.
4. Choose the channels you want to search. Please note that this function only supports to search & play one channel at a time.
5. Click the play button  to start playing. Control the playback with buttons on **Video Playback Controls**.
6. Videos are being played in split-screens.
7. Click the left button of your mouse upon a particular split-screen, the time period of the video split-screen will be displayed on the timeline. The color bar on the top of the timeline indicates the time span of the video split-screen you have Click ed. The color bar on the bottom of the timeline indicates the time span for the whole videos you have searched.



8. Use the timeframe options ( 24h  2h  1h  30m) to view a smaller or larger time period.
9. Tag function, click  to add **Costumed Tag**. Click  to add **Default Tag**. You can make a mark at the current time of the current channel. After the addition is completed, you can jump to the previously made "mark" in the label return interface to play back.

## 7.1.4 Smart Search & Playback

Smart mode allows you to easily search & play the motion events in one or more specific areas of the channel.



This feature can identify whether it is triggered by the Motion in Motion. If so, it will be displayed as blue

in the playback time bar below. Click  button to enter smart area set up page.

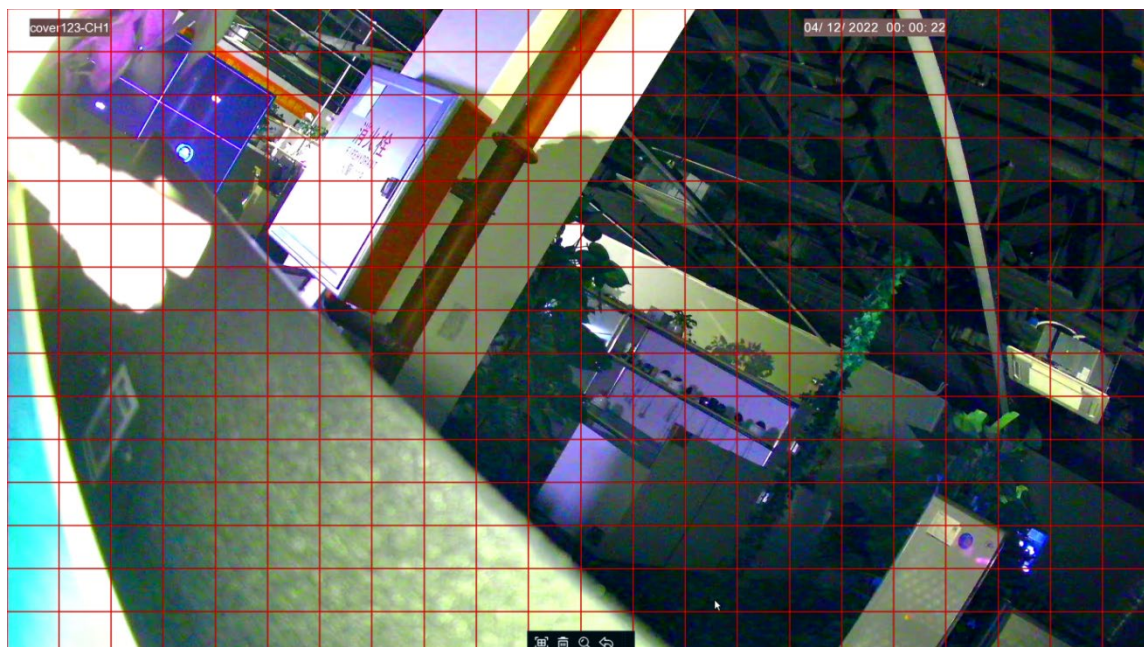

Click this icon  on [Video Playback Controls](#), the camera will be shown in full screen and the Smart controls bar will be visible.

## 7.1.5 TAG playback

In tag playback, you can find all added tags. And perform playback, editing and deletion operations. Click Edit to modify the label name, and click Delete to delete the label.

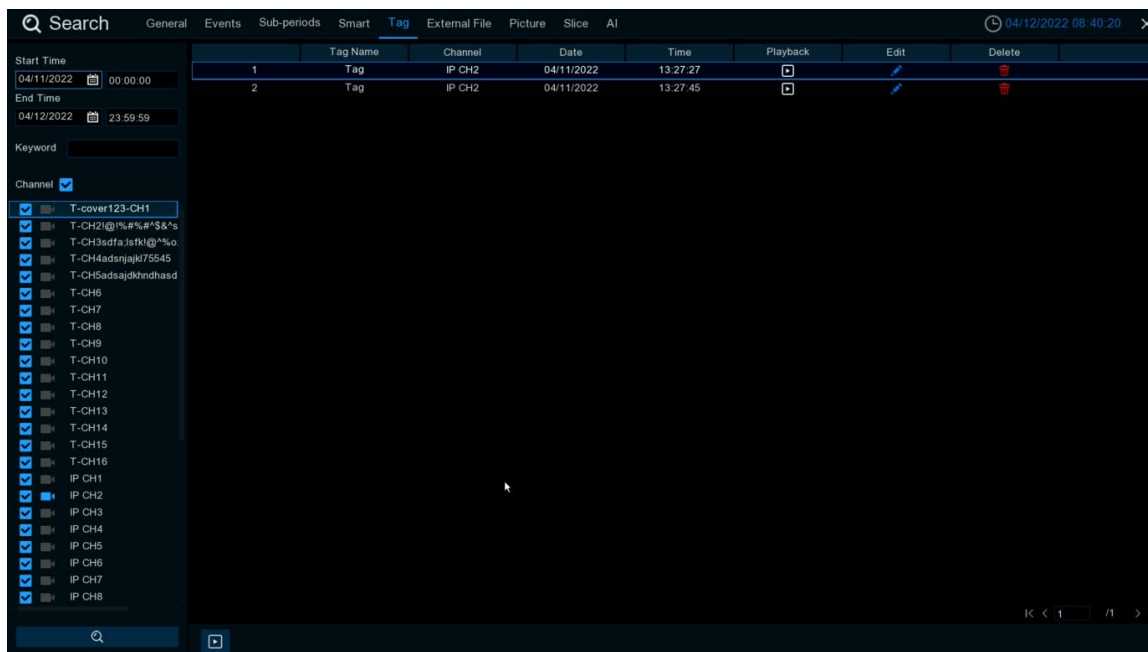

## 7.1.6 External file playback

Here you can play videos in the external U disk. Select files on the left to play automatically.

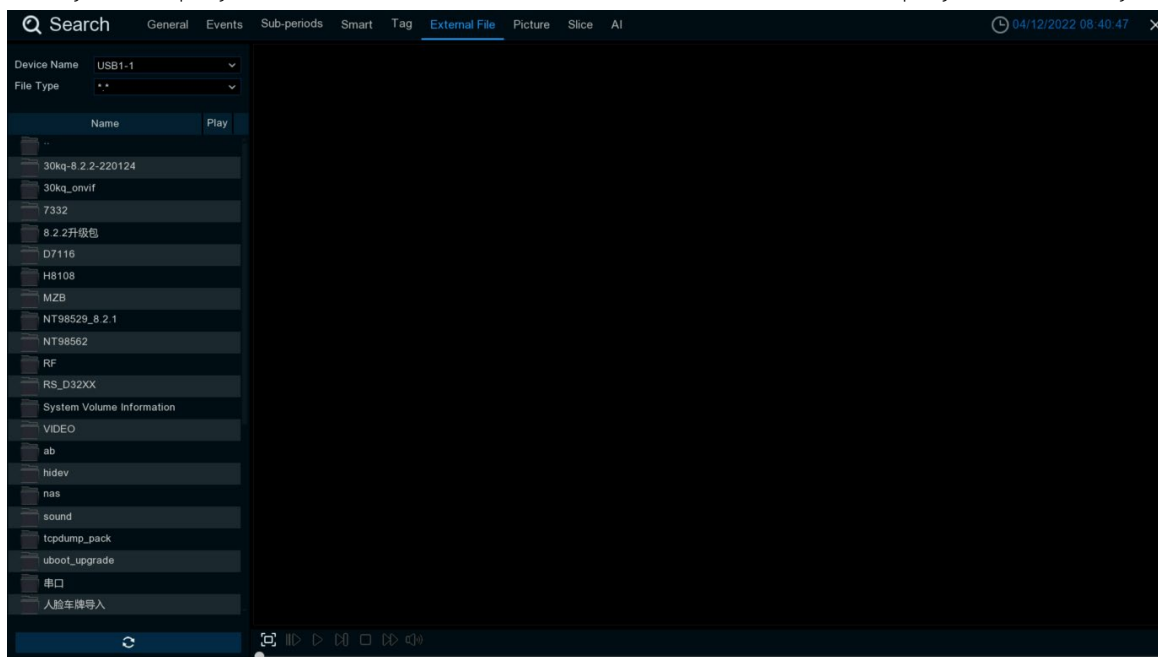

## 7.1.7 Picture Search & View

This function can be used to search, play and copy snapshots to a USB flash drive.

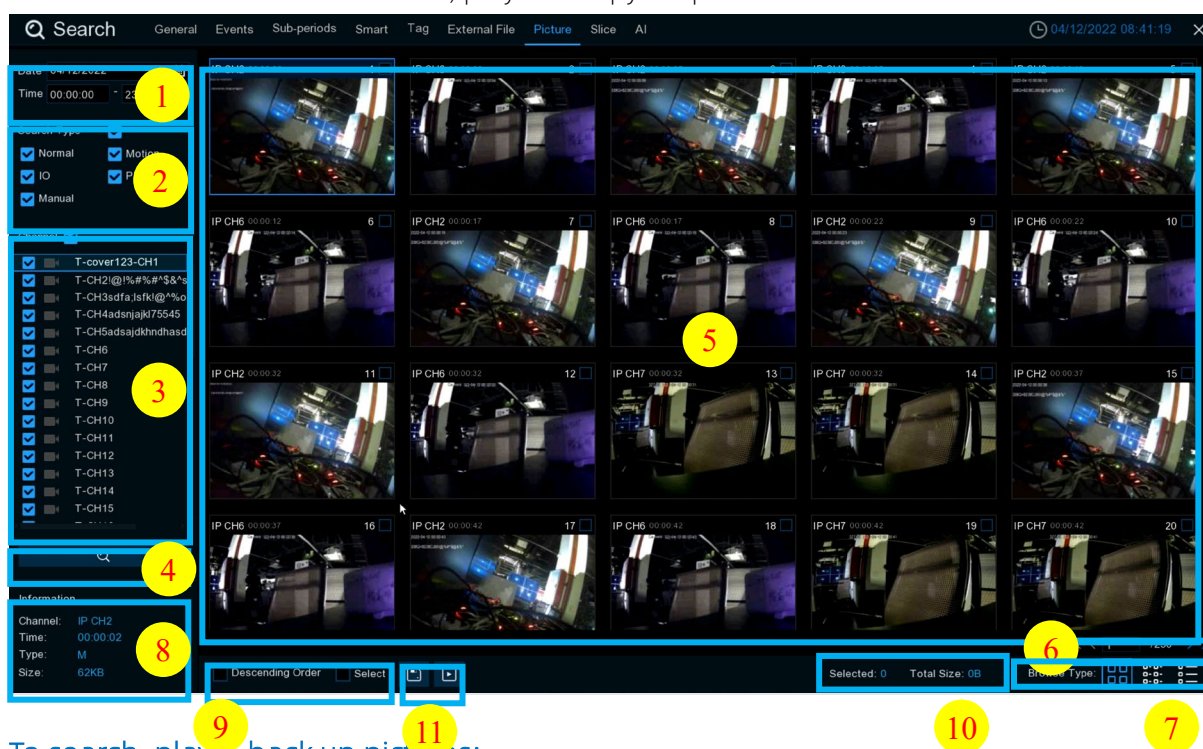

To search, play & back up pictures:

1. Choose the date & time you want to search.
2. Check the picture capture types you want to search, or check **Search Type** to choose all.
3. Choose the channels you want to search, or check **Channel** to choose all channels.
4. Click button to start search.
5. Pictures fitting your search criteria are displayed in list form. You can double Click one of the pictures to get a larger view.
6. Click icons in the bottom-right corner of the menu to browse between pages of pictures, or input the page you want to browse.

7. You can switch the view of list form in by Click below icons which is show at the right bottom corner of the screen:



Thumbnails view. You can view the snapshots of the events.



List view. The events will be displayed in list.

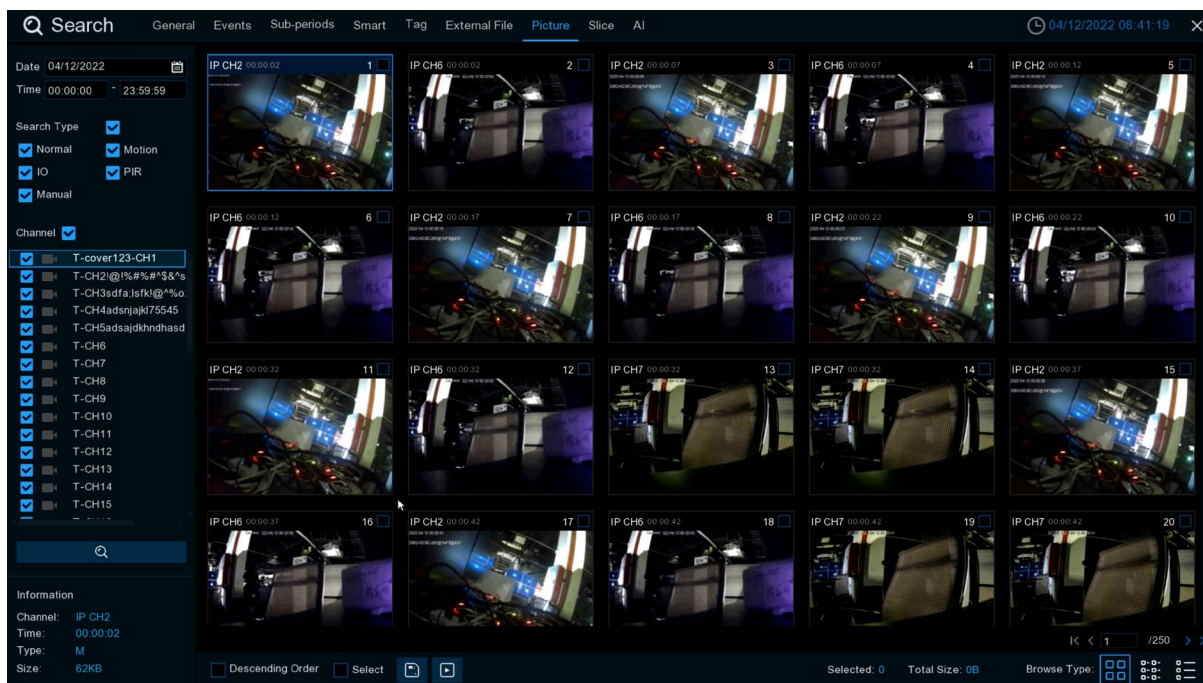

List view. The events will be displayed in list.

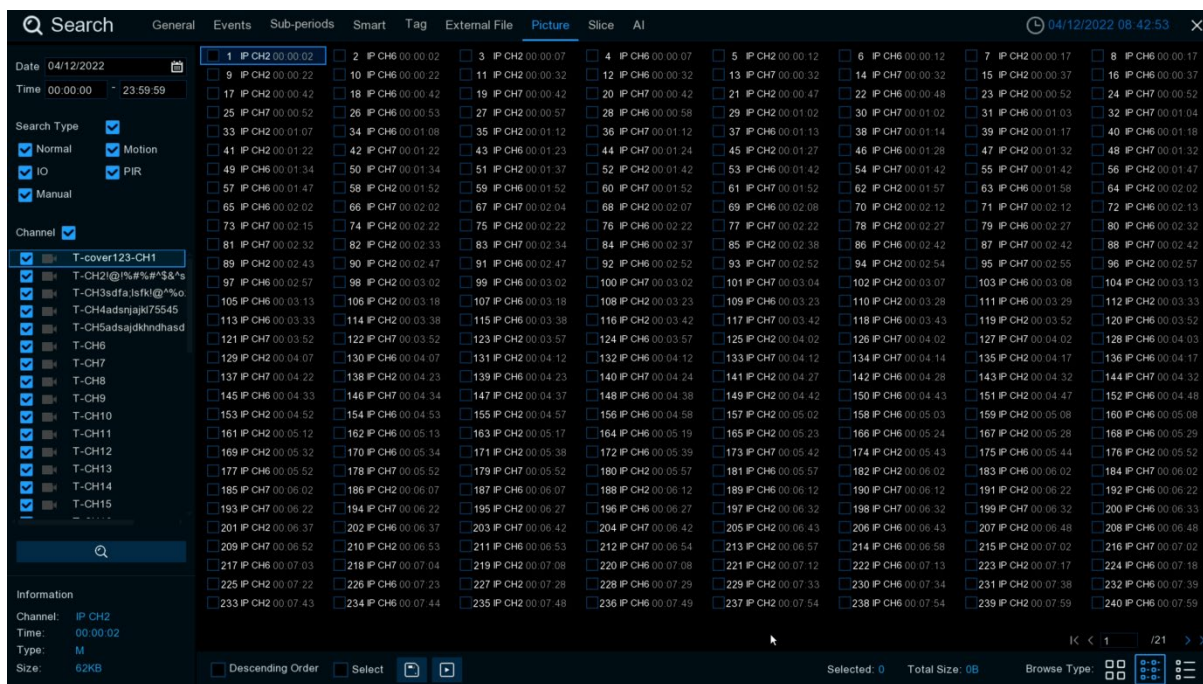



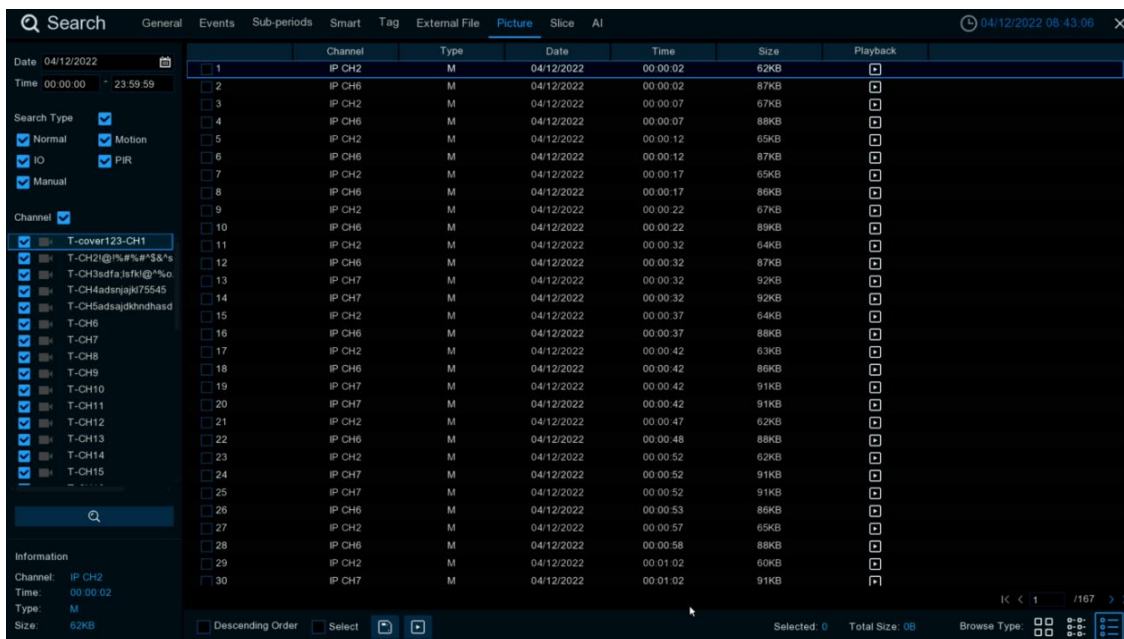





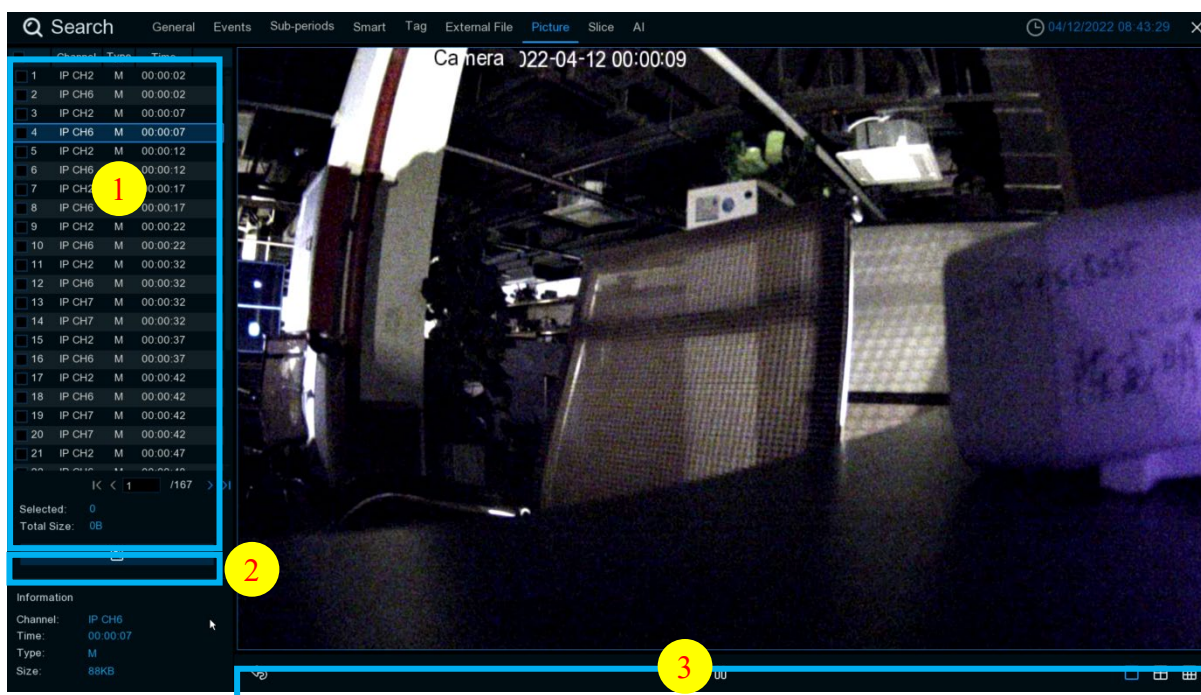

Detailed view. You can view the details of the events.



8. When you Click the left button of your mouse upon one of the pictures, system will show the picture information on the left bottom corner of the screen.
9. Check the box next the number of the event to select files, or check the box next **Select** to select all pictures in the page.
10. The number of selected files, total size information will be displayed at the right bottom of the screen.
11. After selecting file, you can Click button to save the pictures to USB flash drive. Or Click button to go into picture preview control window.

### 7.1.7.1 Picture Preview Control



1. Picture List, you can select the pictures here.
2. Click  button to save your selected pictures to a USB flash drive. Click  button to view the pictures in slideshow.
3. Press  button to exit preview control window and go back to picture search window.  
 Press  button to pause, press  to resume slideshow.  
 Press  button to display previous snapshot or group of snapshots, press  to display the next snapshot or group of snapshots.  
 Click  button to view a single snapshot at a time, click  button to view four snapshots at a time, press  buttons to view nine snapshots at a time.

## 7.1.8 Slice Playback

Video playback allows you to see 60 minutes of video clips within an hour on a certain day, a certain month, a certain year, with 1 minute for each clip.

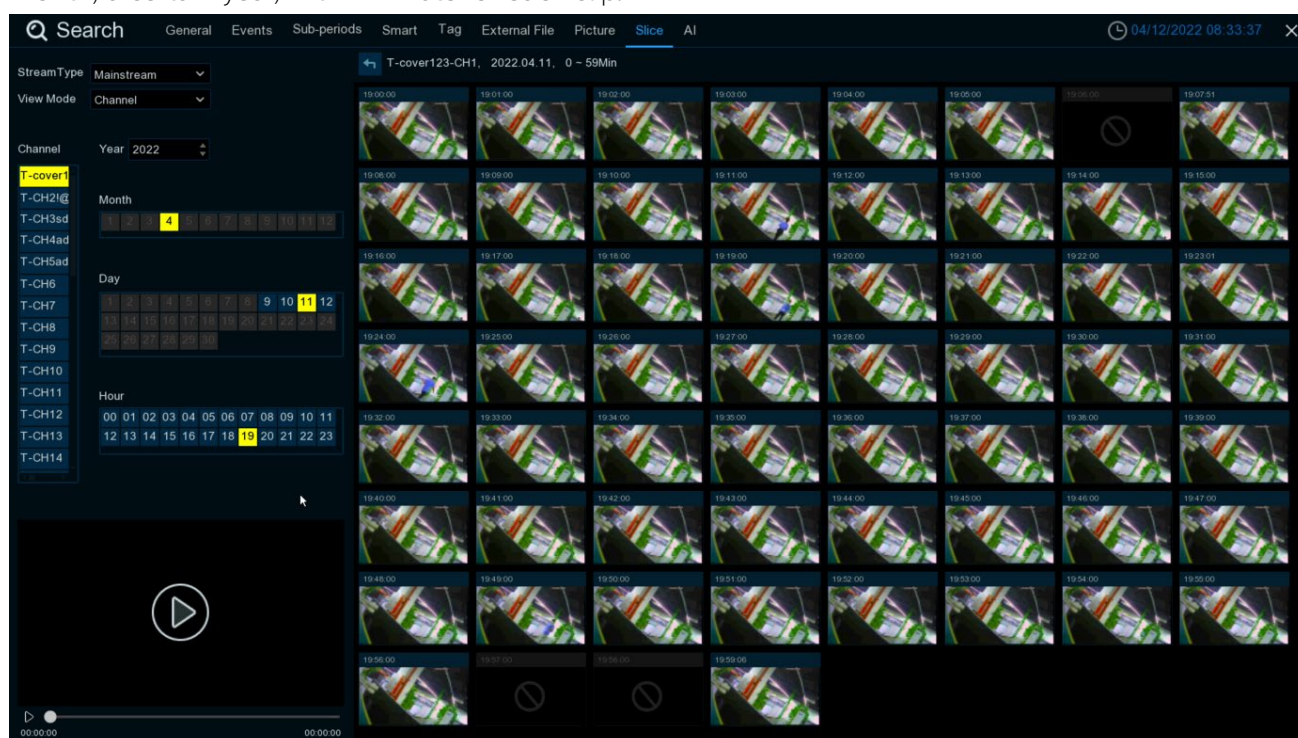





1. Select channel and stream.
2. Select the channel and date to play.
3. The results that meet the search criteria are displayed in the form of a list. You can use the left mouse button on one of the events to play the video in a small window.
4. Small window play preview. Click the enlarge button in the upper right corner of the small window to enter full screen play mode.

## 7.1.9 AI

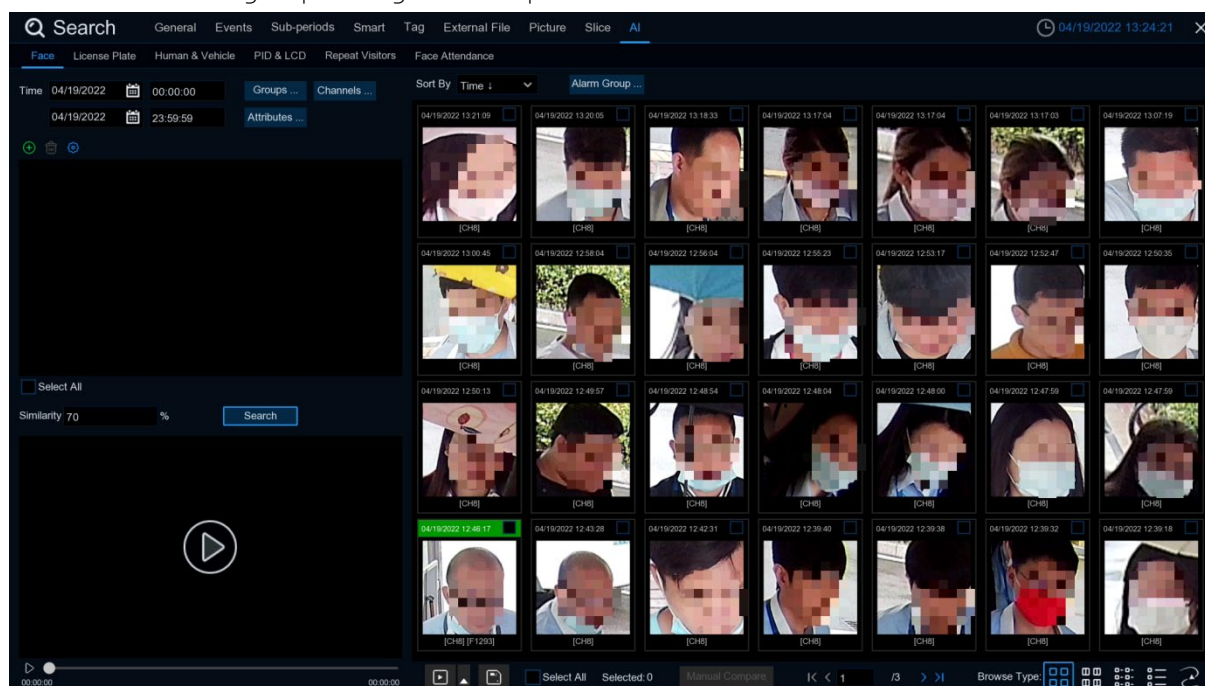
### 7.1.9.1 Face

Select the date, time, channel and face group and click search, you can search the everyone face information of the group during this time period.





1. Click  to customize to add the search face. Choose **Groups** to select the face pictures of the whole group of the face database for comparison search.
2. Click **Channels** to select the channel for the search
3. Click **Attributes** to set the face attribute conditions for the search, and you can choose to select Gender, Age, Mask, Glasses and Expression
4. Click **Alarm Groups** to select the face group where the face contrast has occurred
5. Select the search area picture, click  to delete the picture, click  to pop up to the AI face database setting interface.
6. Right-select **Import To** in the search results to import this image into the face database grouping..
7. In the search results, right-select **Detail Information** to view the details of the face.
8. Click **Custom Playback** to enter the time when the face is detected for playback.
9. Click  to view the different viewing methods.

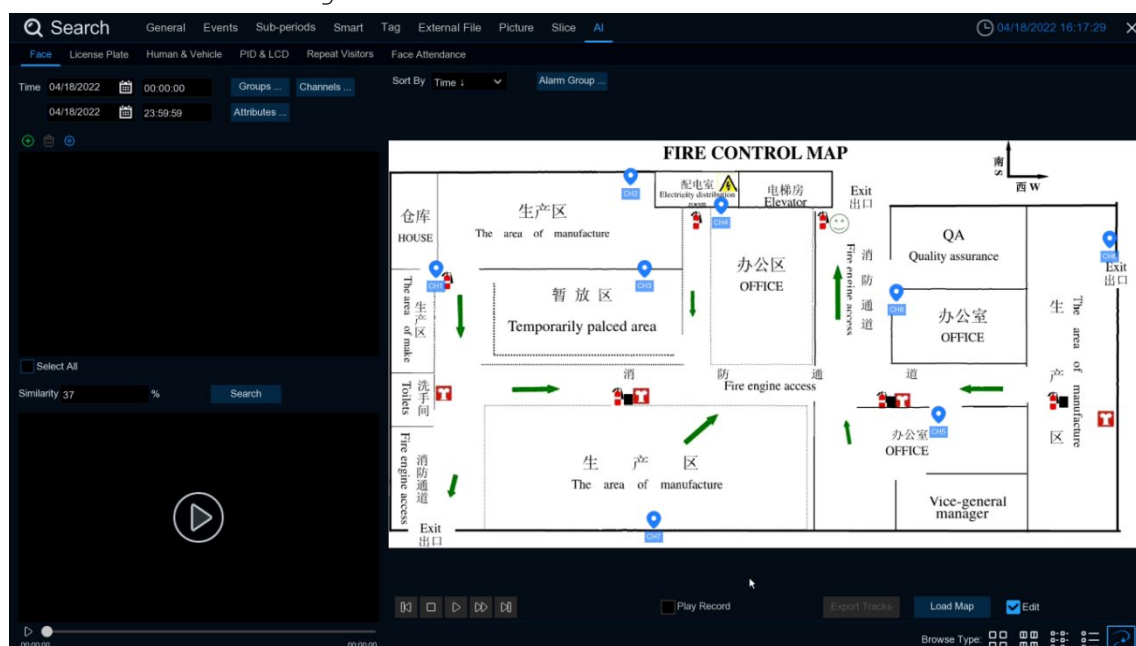

### 7.1.9.1.1 Track

Click  on the lower right corner to enter the electronic track chart menu.



Click Load Map to pop up U disk, select map to add. Click Edit to drag the IPC icon to the location you want to place, unchecked and exit edit mode. Then Click  select the face from the local face library or U disk, click search (only support one face search), you can search out the IPC that has detected the face, there will be a color mark on the map.

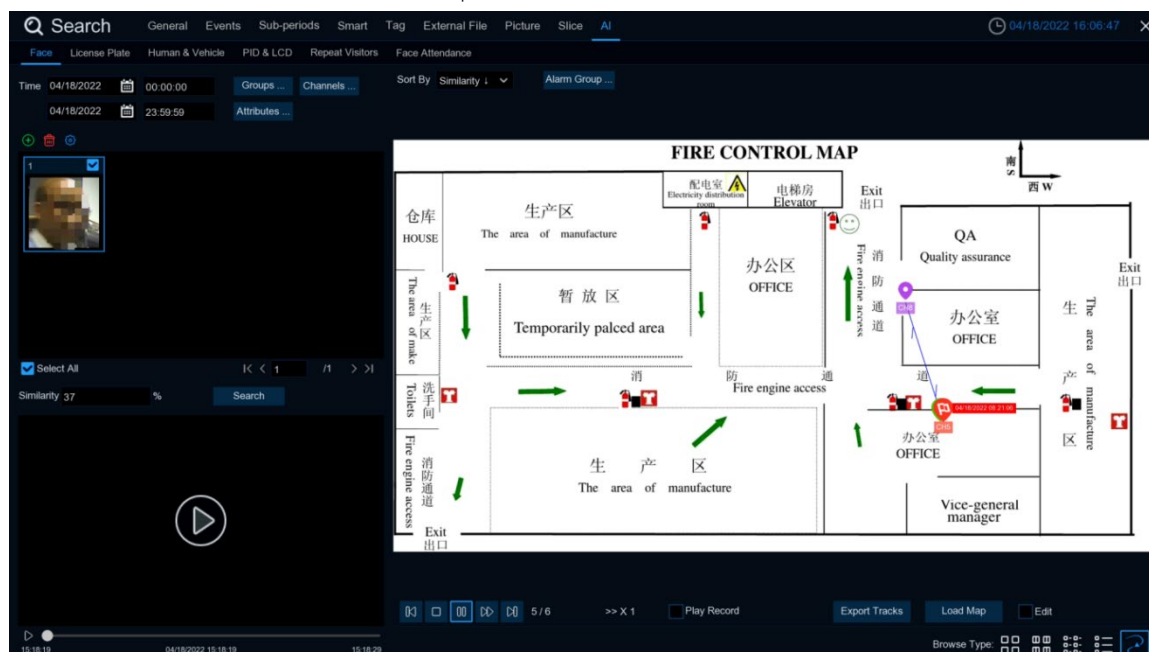

If you click the left button on an IPC icon and play back, there will be a simple playback in the lower right corner. If multiple IPC detect the face, the point playback will automatically judge the person's movement and introduce an arrow.

## 7.1.9.2 License Plate

If the alarm is triggered and the video is recorded, you can view the video details or export in this interface.

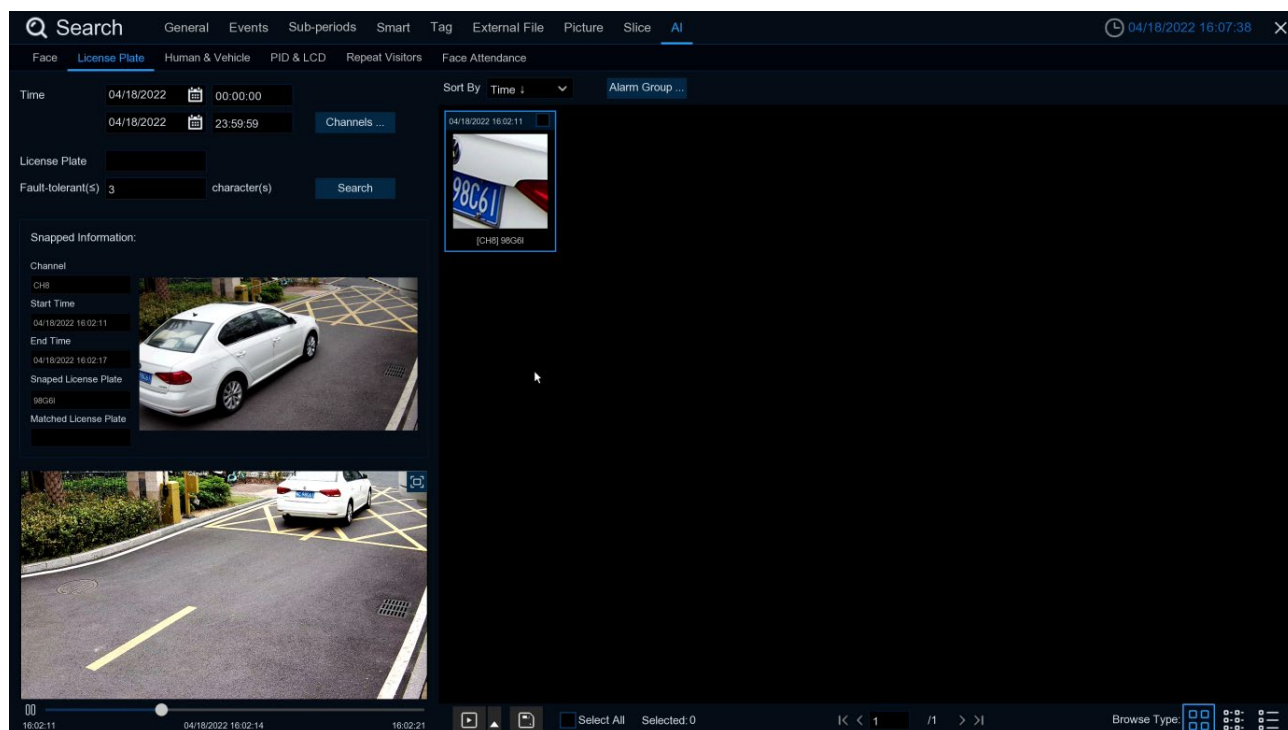

**Time:** Set the time period to query the license plate detection event. The date can be set by Click  on it.

**License Plate:** Filter and query according to the license plate information.

**Fault-tolerant:** Fault tolerance rate, such as when set to three characters, the white list in the group is B594SB, and also triggered when a license plate number of B734KB enters the monitoring area. That is, the detection license plate number has 0~3 characters and the database license plate number is different will be identified.

**Snapped Information:** Details of the alarm event, with the following five items:

**Channel:** Channel selection

**Start Time:** Start time of the event.

**End Time:** End time of the event.

**Snapped License Plate:** The license plate number captured by the camera by taking the license plate photo.

**Matched License Plate:** License plate number obtained from the database.

**Sort By:** Event videos are sorted by time.

**Channels:** License plate detection events triggered by each channel

**Search:** Query according to the selected settings.

**Alarm Group:** Select the different groups in the database to compare and search for the display results.

 This function is to Click the triangle icon in the lower right corner of the event video when selected: 5s, 10s, 20s, 30s, 1min, 2min, 5min, 10min, Custom Playback. If 30s, the video will be extended by 30 seconds.

 You can back up the video to the U disk, the video format support RF, AVI, MP4 three.

 All videos are selected and the number of videos selected.

 Click to turn the page.

Click  to select different views.

Choosing an event right-Click pop two features:

**Detail information:** View the event details.

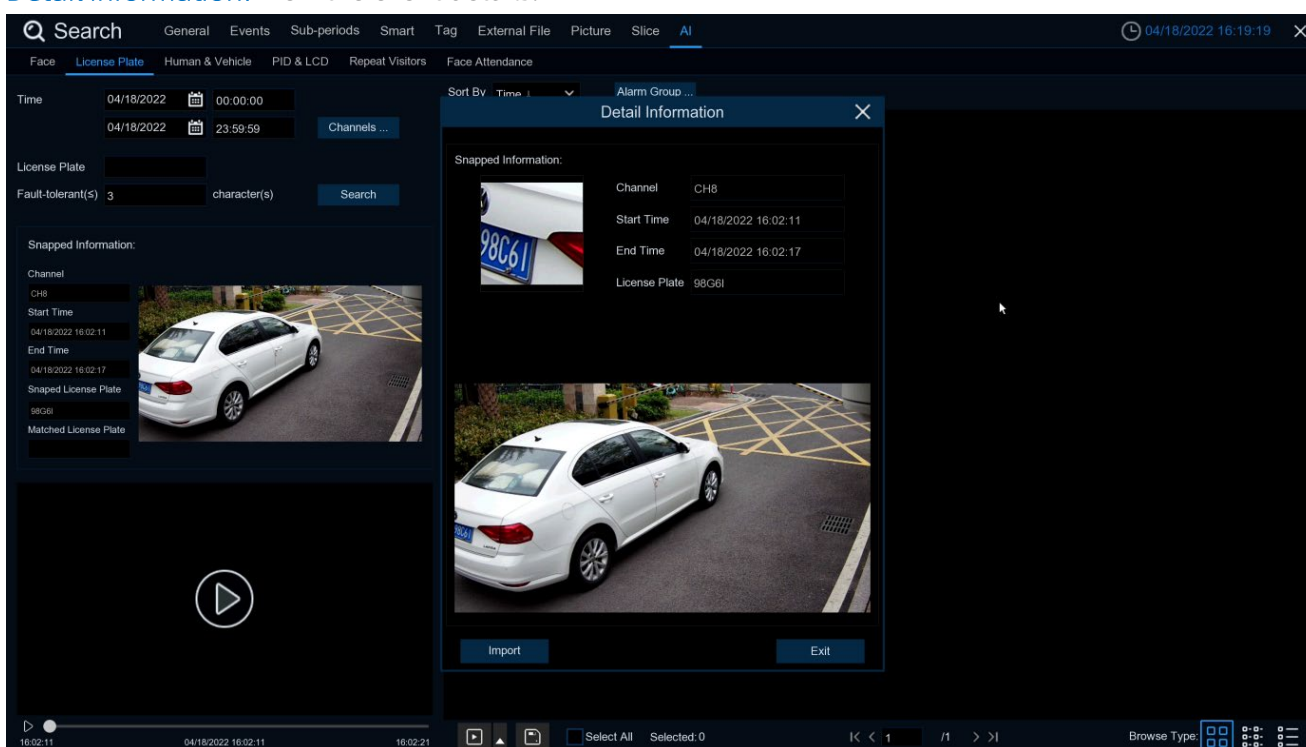

**Custom Playback:** Playback settings, click to set how long the event plays earlier and how long it delays. The maximum time limit is 10Min.

Double-Click the event or drag to the bottom-left corner to play the event video.

### 71.9.3 Pedestrian & Vehicle

After selecting the date, time, channel, and pedestrian and car shop type, click to search to search for the pedestrian and car shop information of the group during this time period.

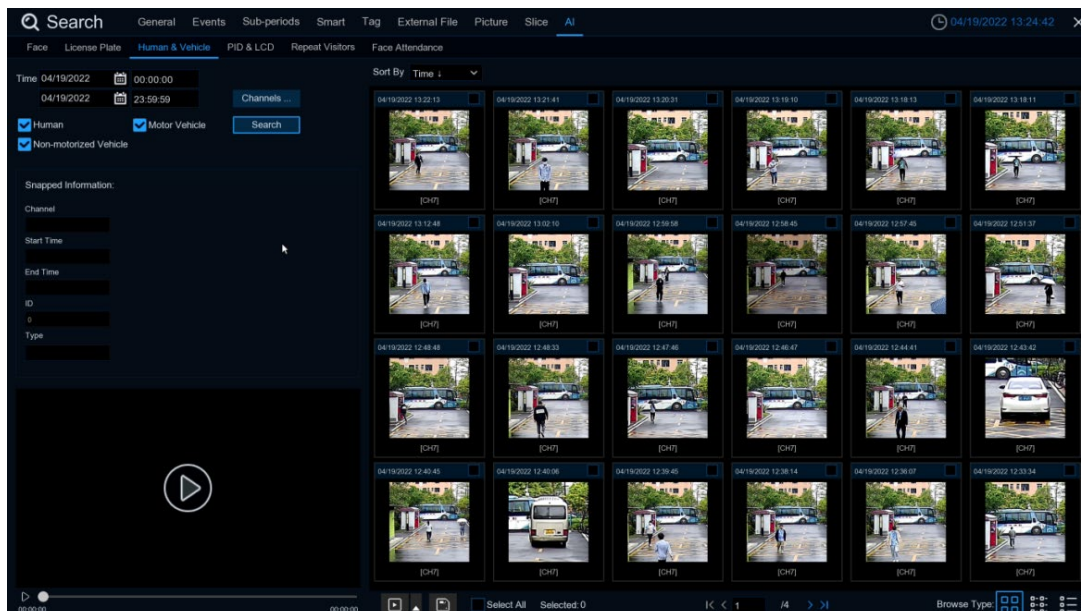

Left Click will have basic information on the left side, right click will customize playback and view details. Click on the lower left corner to play for simple playback, double-Click to zoom in, and enter the normal playback mode.

### 71.9.4 Perimeter Intrusion & Line Crossing

Select the date, time, channel, and alert type, and the person and car type to search for the Perimeter Intrusion and Line Crossing triggered by the group during this time period.

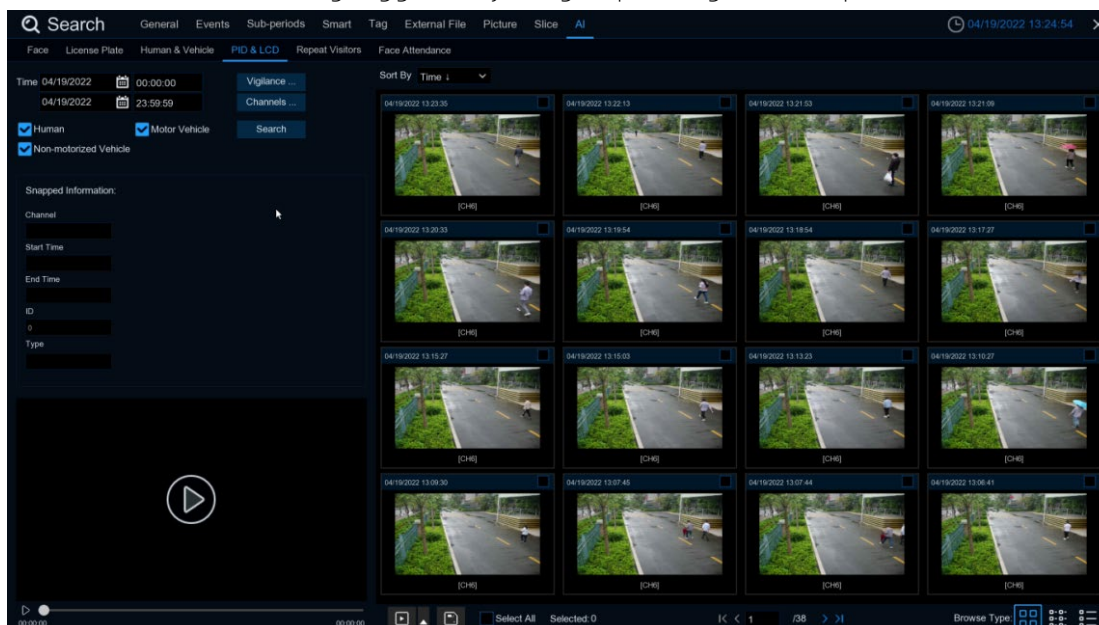



Left Click will have basic information on the left side, right click will customize playback and view details. Click on the lower left corner to play for simple playback, double-Click to zoom in, and enter the normal playback mode.

### 7.1.9.5 Repeat Visitors

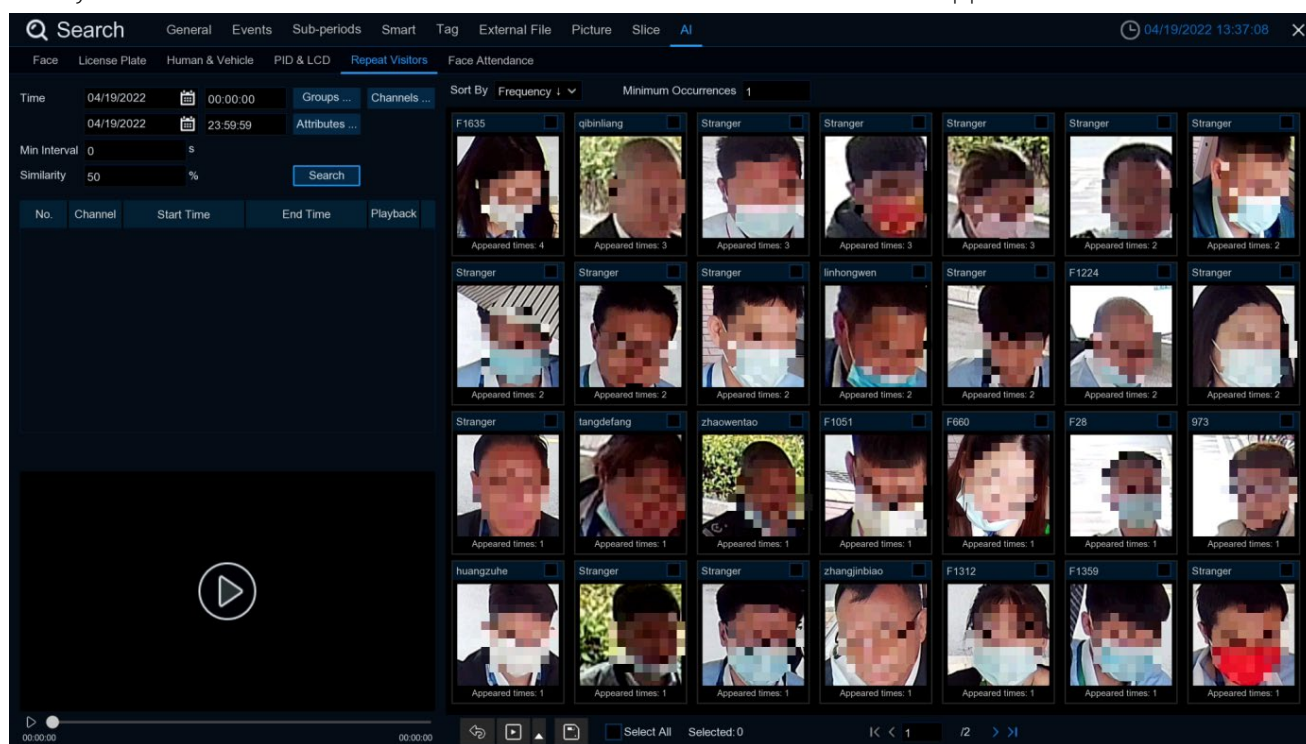
Here you can search and count all the number of times the same face has appeared.



1. Select the date and time that you want to search for.
2. Select the face library group you need to contrast and search groups by default.
3. Select the channel that you need to search for.
4. Select the corresponding face attribute in the face attribute **attribute** interface.
5. Enter the minimum number of seconds separated by interval.
6. Left Click the search results, click the search results, on the left there will be detailed playback and information, right click to import the face library or edit the face library picture information and view the details.
7. Enter the **Minimum number** of face appearances at Minimum Occurrences for filtering
8. Click Sort By to sort, with a rise or down order of time or quantity
9. Check the search results or Click All to select all the search results, click  icon to customize the play, or Click  to backup the picture and video to the USB flash drive.

## 7.1.9.6 Face Attendance

The attendance system lets you check to see if someone appears at the specified time. And automatically determine whether they are late or leave early.

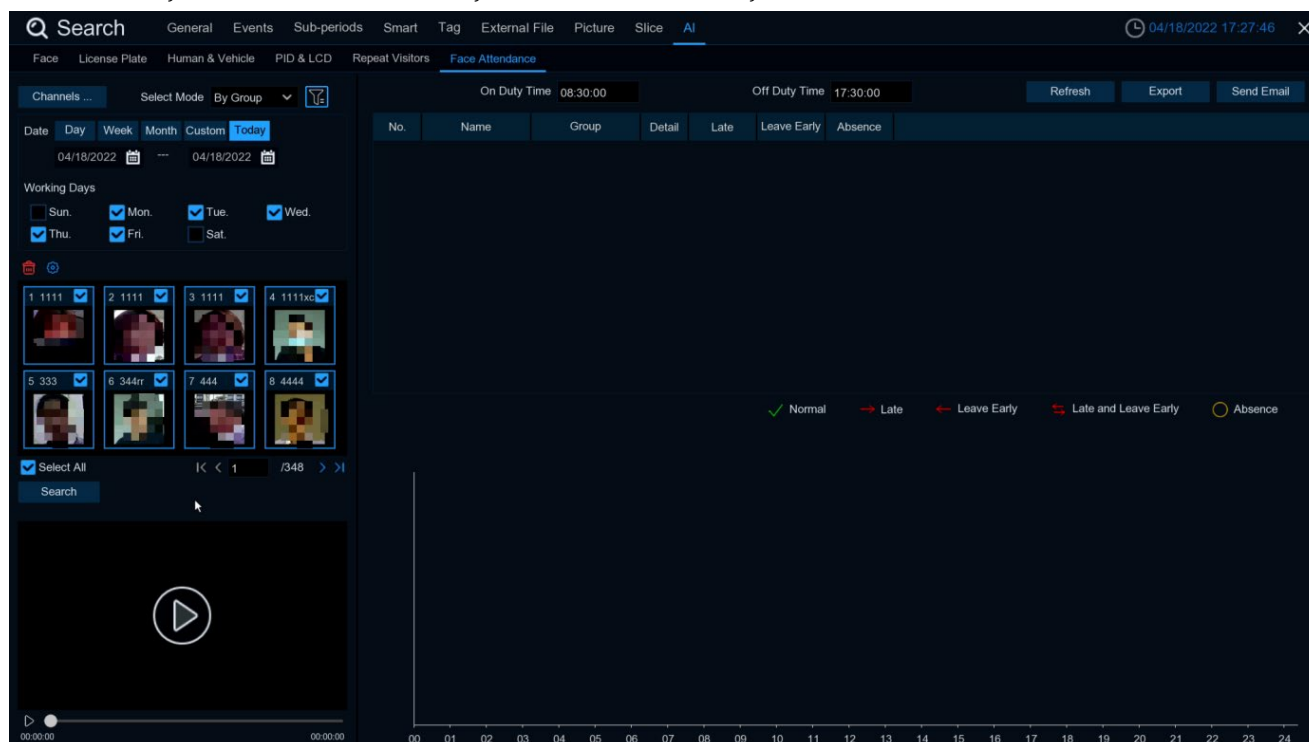

1. **Channels:** Select the channel for face attendance
2. **Select Mode:** Select the face picture of attendance, with By Group and By Person modes
  - By Group:** Select face pictures through the face group, that is, add shuffling all face pictures.
  - By Person:** Through the face map selection, click the right button of By Person to pop up the face map interface of the selected face library.
3. **Date:** Select the search date, the default is the system time day, and there are five selection modes: Day, Week, Month, Custom, and Today.
4. **Working Days:** Select the working days
5. **On Duty Time:** Set up the working hours
6. **Off Duty Time:** Set up the closing time
7. Click **Search**.ou can search for the results.

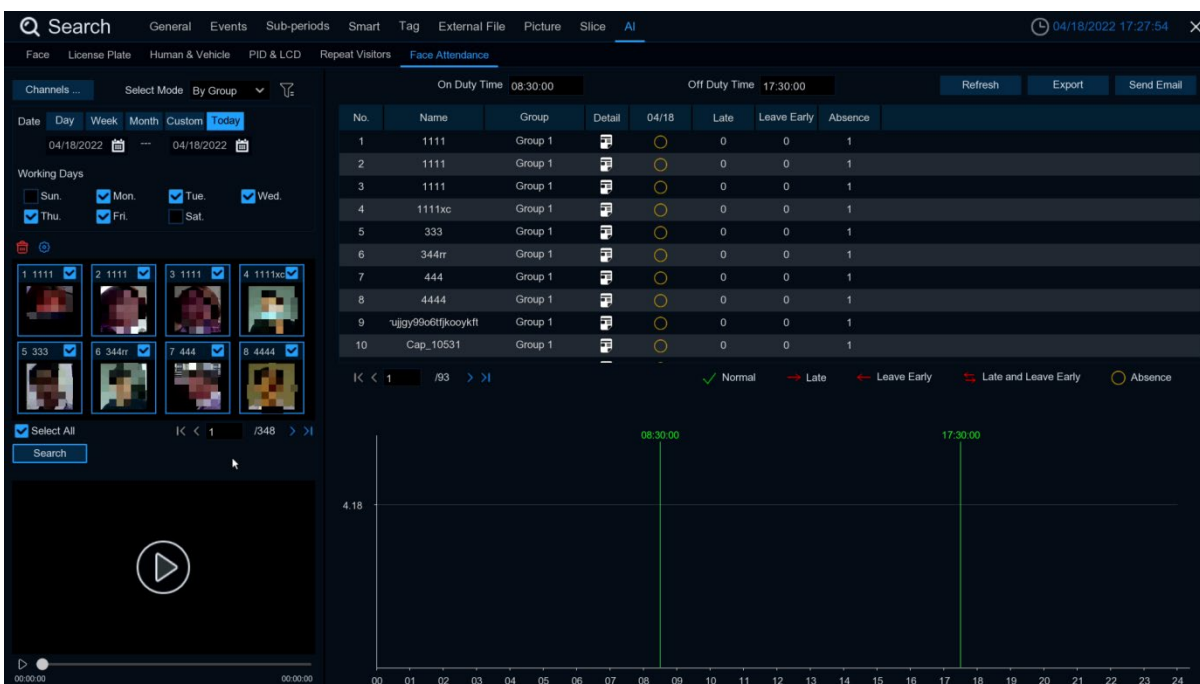

Click on a result, and all the detection records are displayed below. Click  Detail on the Detail icon to enter the details interface.

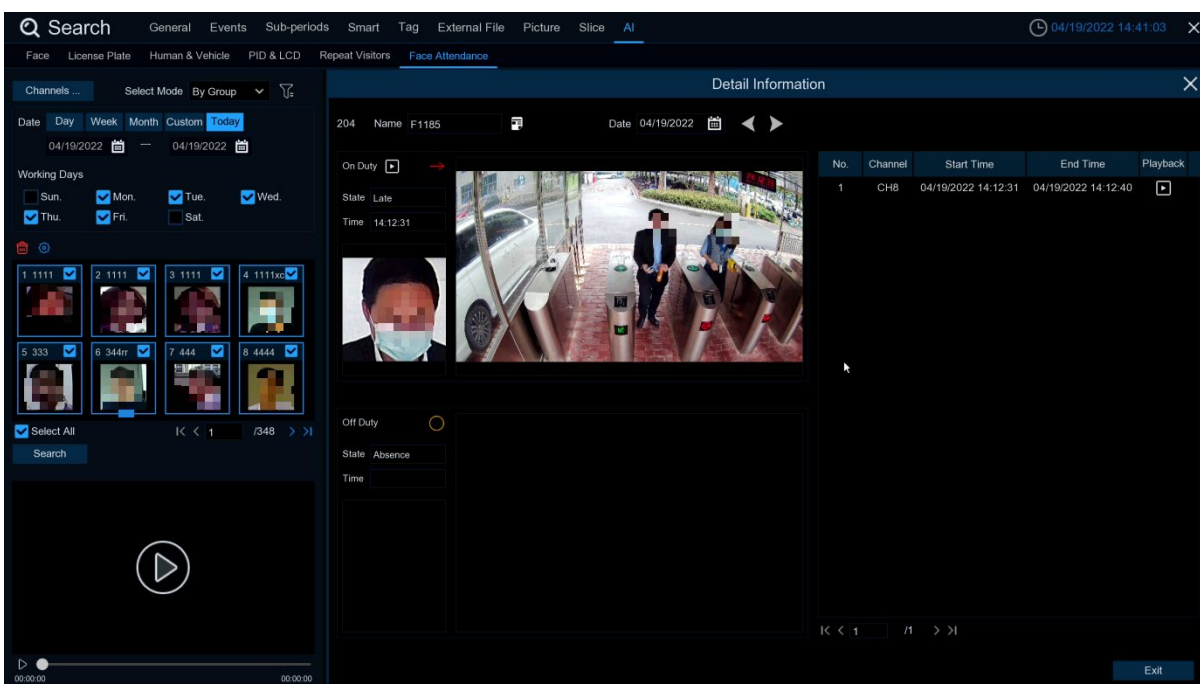

Here are details on attendance, including the first appearance and the last appearance. Click  to perform a simple playback in the lower left corner.

Click **Export** to save the searched attendance information generation file to the U disk.

Click **Send Email** to send the searched attendance information generation file to the mailbox.

## Chapter 8 Remote Access via Web Client

Use the Web Client to remotely access your DVR at any time via a PC. Before you access the Web Client, you need to ensure that the internet settings of the DVR are configured properly.

### 8.1 Basic System Environment Requirements

The minimum requirements for hardware and OS required to run Web Client are given as below.

Item	Minimum	Recommended
CPU	Intel® Core™ i5 CPU	Intel® Core™ i5 CPU or higher
RAM	4G or more	8G or more
Hard Drive	500G or more	1000G or more
Display RAM	2G or more	4G or more
Display Resolution	1280*1024	1920*1080
OS	Windows 7 or above Mac OS X® 10.9 or above	
DirectX	DirectX 11	
Direct3D	Acceleration Function	
Ethernet Adapter	10/100/1000M Ethernet Adapter	
IE	Microsoft Internet Explorer Ver. 11, 10, 9, 8 or above	
Mozilla Firefox	V51 or below. It doesn't support V52 or above version.	
Google Chrome	V44 or below. It doesn't support V45 or above version.	
Mac Safari	5.1 or above	



## 8.2 Web Plugin Download and Installation

To access the Web Client, do the following:

### For IE Browser:

1. Launch the explorer on your PC and enter the DVR IP address or DDNS domain name (Host Name) you have set on DVR in the URL box.

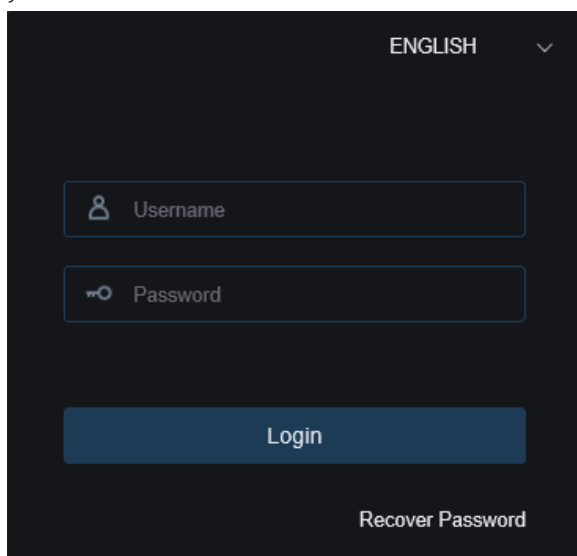

2. For the first time you run the web client, system will require to install the web client plugin. Click **download** to download the plugin and install to your computer.

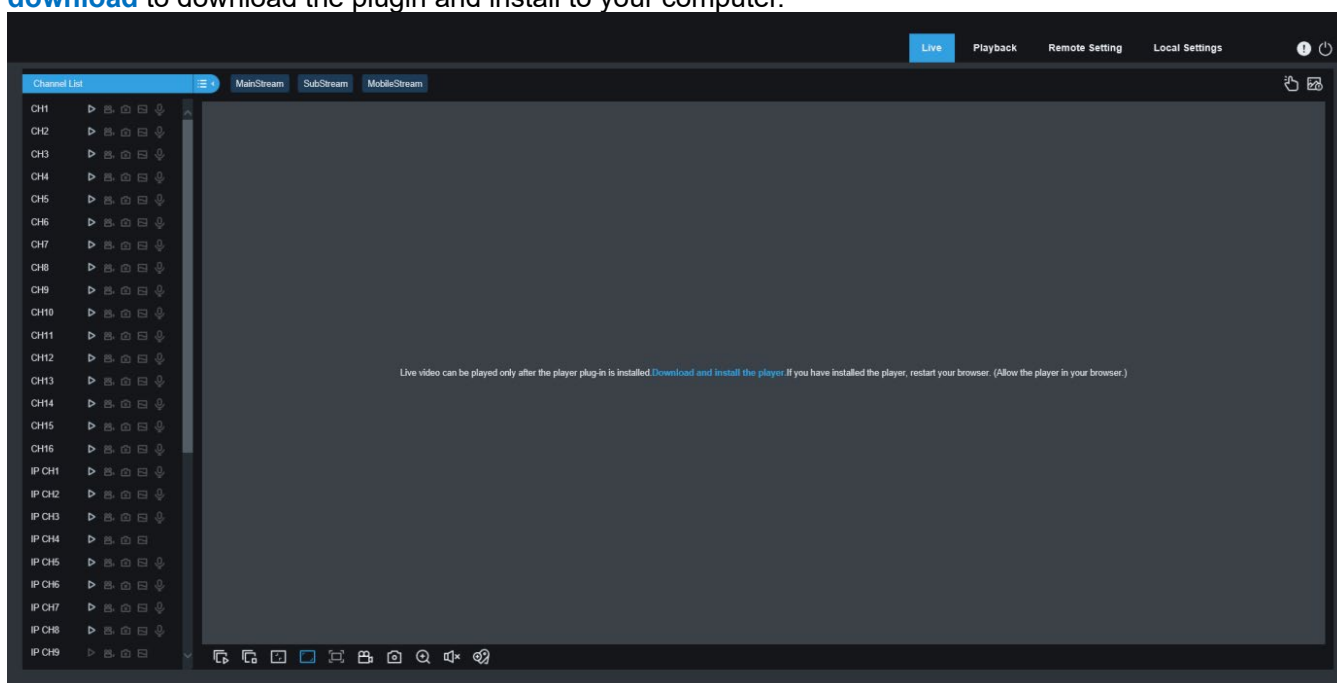

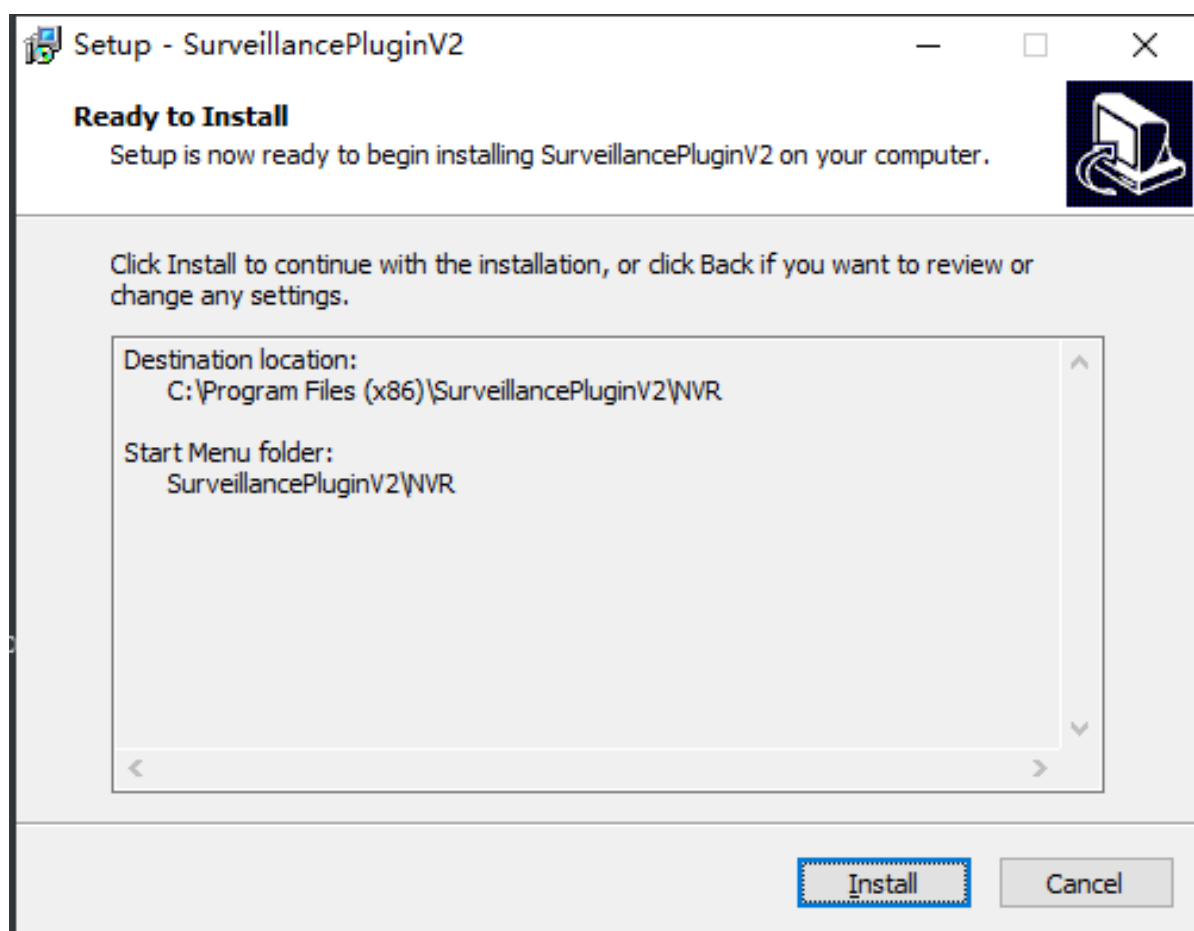

3. After installing the plug-in, close & launch again your browser and repeat step 1 to open the login page. Input your user name and password to login the web client.

**Note:** When using Apple Safari/Google browser/Firefox browser/Microsoft Edge browser, you do not need to download the plug -in, you can log in to DVR directly.

## 8.3 Web Client Manager

The web client supports to fully control the DVR with administrator account. Please make sure to protect your user name & password for preventing illegal login.

### 8.3.1 Live Interface

This is the first screen that opens after you have logged in to the Web Client. Here you can open or close live preview, record video to local computer manually, take snapshots of the screens, PTZ control, color adjustment, etc.



#### 1- Channel: Quick turn on camera channel

Click icon show channels list.

Click icon shut up channels list.

Enable/off live streaming. While real time streams turn on, the icon is blue.

Manual record, click and start to record manually. Click icon again to stop recording and the records saved to local PC. Manual recording icon shows blue which recording.

 Manual capture. Click to save the snapshot to your local PC.

 Bitrate icon. Camera set up main/sub/mobile streaming. Mobile stream only be used in IP channels.

**2- Realtime setting:**

**Main stream:** High video quality to view on main stream.

**Sub stream:** Middle video quality to view on main stream.

**Mobile stream:** The lowest video quality to view on mobile stream. Advantage: use smaller bandwidth, only support on IP camera.

**3- Main menu:**

**Preview:** Check realtime video on camera.

**Playback:** Check the records in DVRHDD drive.

**Remote setting:** DVR menu to set up device parameters.

**Local setting:** Set up Web records and picture save location, select video" file type" .

**4- Information:** Mouse stop, check system user, IE version and plug-in version .IE version and [Cancel](#).

**5- Manual Alarm:** Manual enable /disable Alarm Out



6- Color setting: Click to hidden the settings.



7- AI alarm: Trigger AI alarm push, click  Click AI type detection, click  to delete.

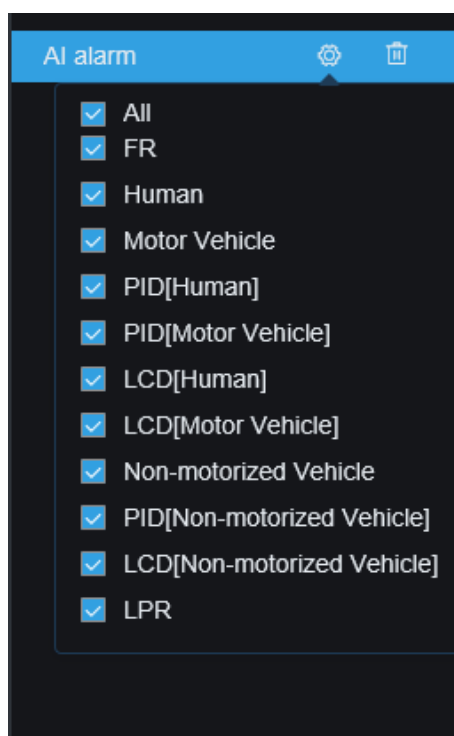

8- PTZ Control: Click to show/hidden PTZ.

9- PTZ Control Plug-in

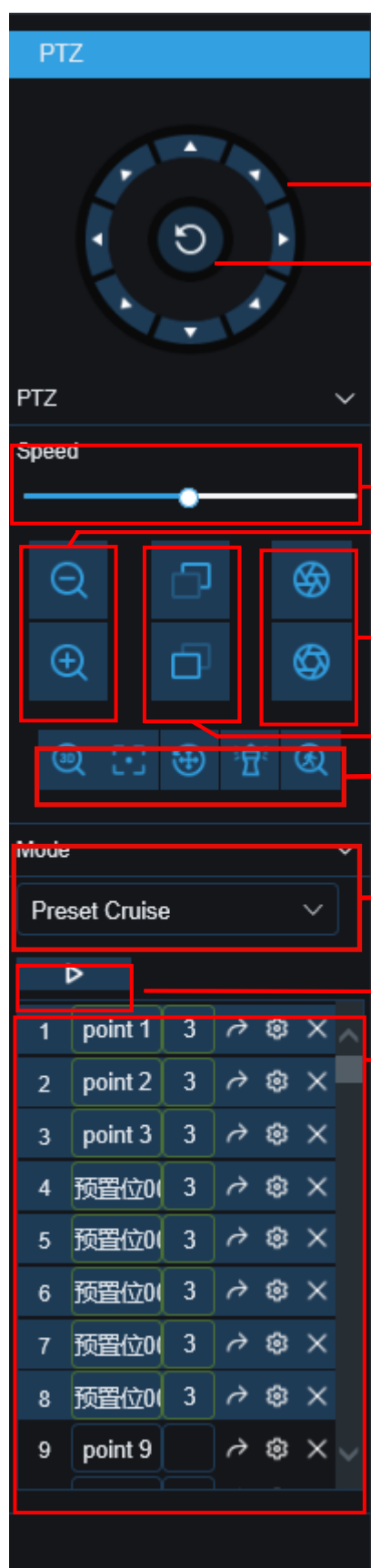

- Direction arrow: long-pressing the surrounding direction keys can control the level of PTZ levels, vertical and etc.move PTZ
- Default cruise
- PTZ speed: adjustment horizontal bar is divided into 1--100
- Zoom+/Zoom -: Click- /+ to control lens enlarge and narrow
- IRIS: Clickthis button to adjust IRIS enlarge or narrow
- Focus: Click- /+ adjustment the lens focus
- The first icon is 3D PTZ, the second is auto focus, the third is reset PTZ, the fourth is watch point mode, the fifth is manual human tracking.Please view in [5.1.4.1 PTZ Control](#)
- PTZ Mode: PTZ, PRESET, Line Scan, Watch Mode, Tour, Pattern Scan Please view in [5.1.4.1 PTZ Control](#)
- Cruise: Start/stop PTZ cruise
- Preset: modify preset point name, move to, add, delete

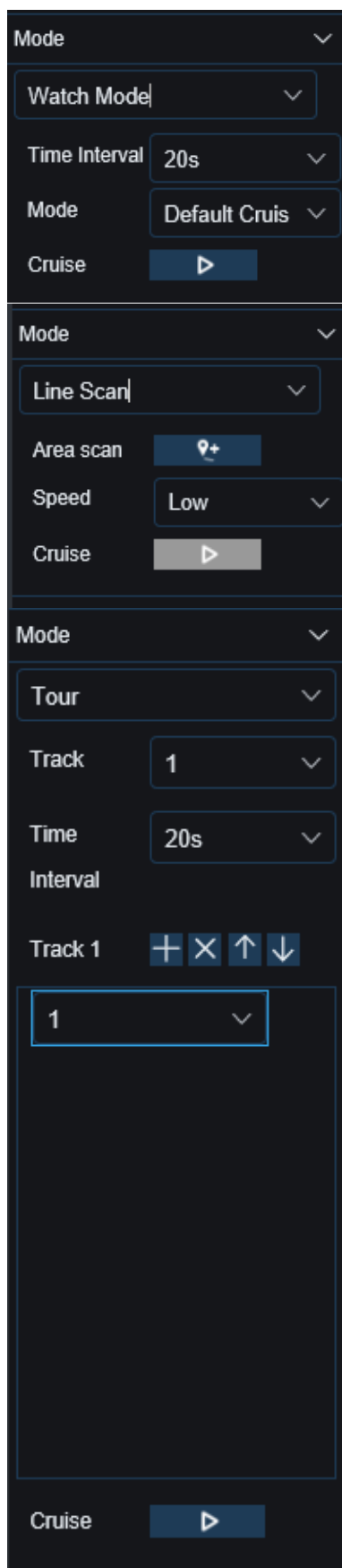

Watch Mode:

Time Interval: watch mode waiting time interval, the time since stop watch mode operation.

Mode: select watch mode, default/preset/line scan/tour/pattern scan

Line Scan:

Area scan: Click to record the start position, after moving PTZ, click to record the stop position.

Speed: Line scan speed.

Click to start line scan, PTZ start line scan. PTZ only move in the same horizontal direction on this mode.

Tour:

Time Interval: every point stay time.

Click to add preset point, click to delete preset point, click / move up/move down preset points, click to start cruise.

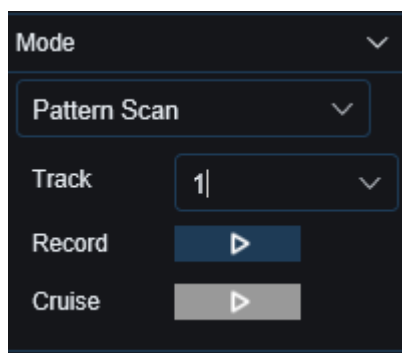

Pattern Scan:

Record: Click  to record the cruise route, click  to stop record.

Cruise: Click  to cruise the recorded route

10-Live View Control Buttons:



 switch windows modes

 Open all of channels

 Close all of channels

 Original: display preview with original scale

 Stretch: stretch the live window to suitable every scale screen

 full screen

 Manual record: Click the manual recording of all the display channels. Click again to stop recording. Manual video is saved to your PC

 Manual capture: Click to grab the screen of all the current display channels to save to your computer

 Digital: Click live image, click -one part of image zone to enlarge.Right-Click to return back normal view.

 Volume control: adjust level volume +/- .  Mute mode

 Intercom: Click to speak with DVR, re-Click to turn off. (Note: this function need DVR supports)

 White light, manual control siren and white light (Need IPC supports) .

 Siren, manual control siren to alarm (Need IPC supports) .

 Click to add customize tag please ([7.1.5 TAG Playback](#))

11-Guide: display the current channel number.Use direction keys to control.

12-Page: Click channels to show on the screen.



## 8.3.2 Playback

You can search & play recording videos stored in the HDD inside the DVR, and download the videos to your computer.

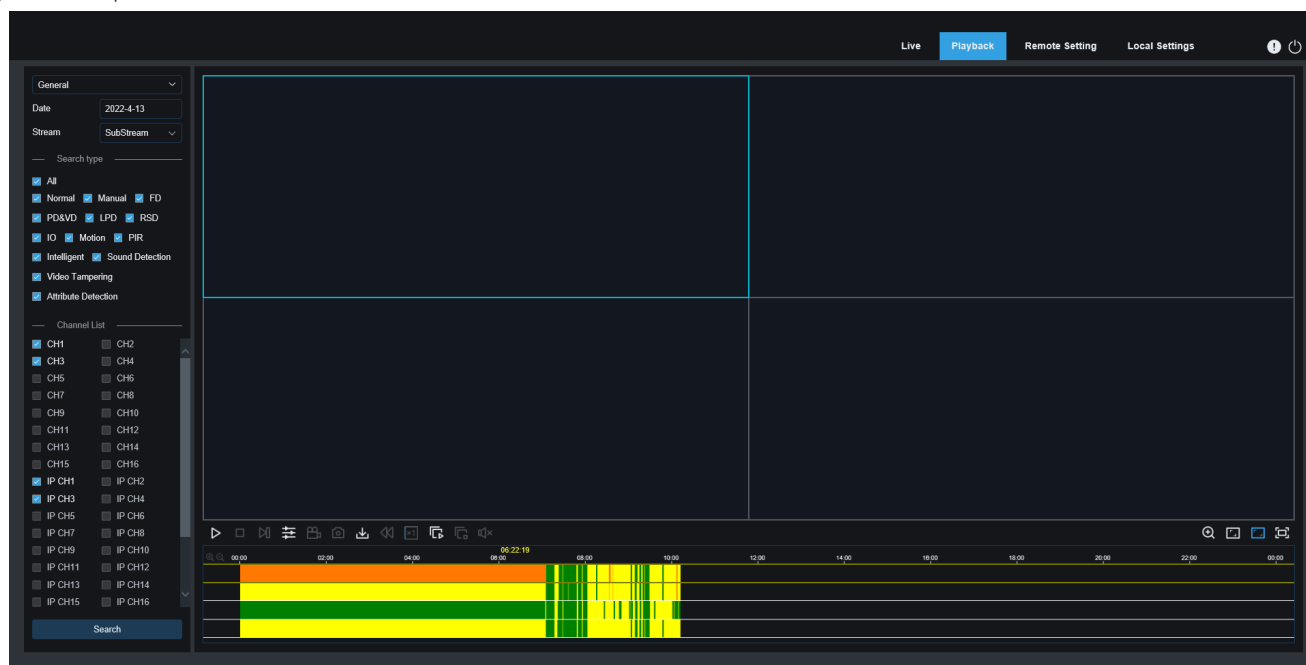

### To search recordings:

1. Click **Playback** in the top-right corner of the window.
2. Select a day on the calendar to search for recordings from. Days with recordings appear with a red underline.
3. Select the recording type to search for from the dropdown next to **Type**, or select **All** to search for all recordings.
4. To choose the video stream you want to search & play. If you want to play Substream recordings, please make sure you had set the DVR to record with Dualstream at [5.2.2.1 Record](#).
5. Check the channels you would like to search for recordings from. Check **Synchronous playback** to play all channels at once.
6. Click **Search**.
7. Recordings that fit your search will be displayed in the timeline. Click a section of video where you would like to begin playback and click the ► play button.

### 8.3.2.1 Playback Control Buttons

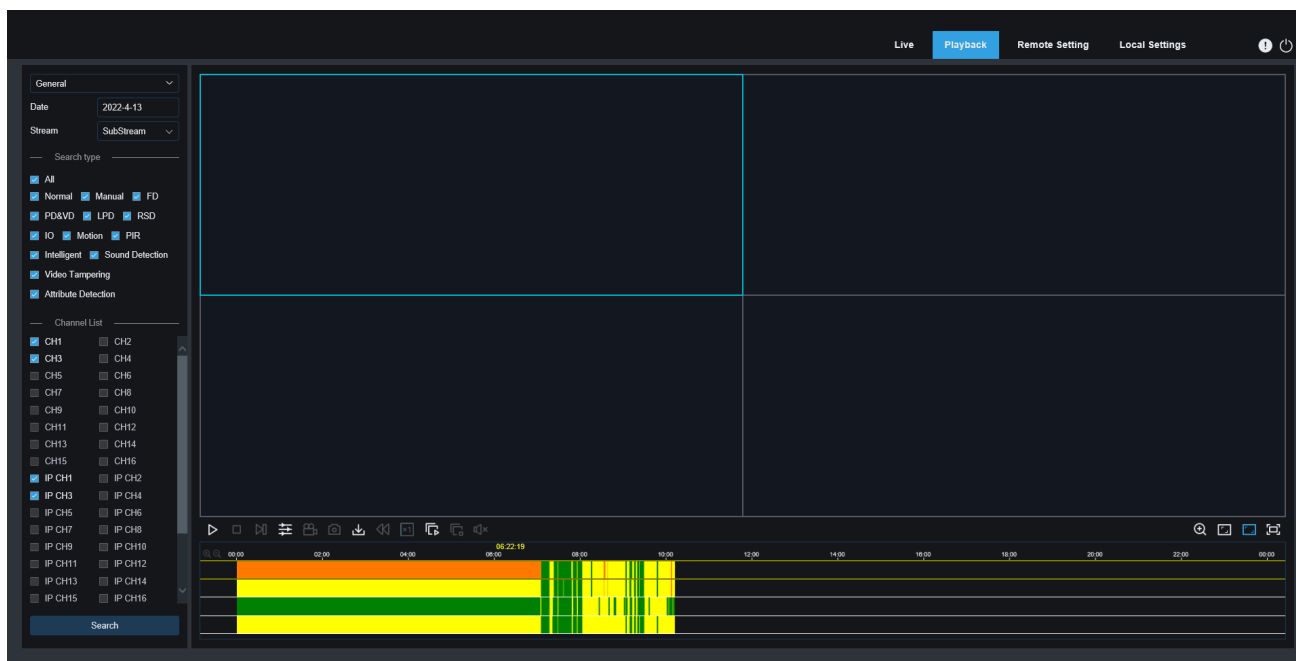

 Play the recordings

 Pause

 Stop

 Go Forward One Frame: Move frame-by-frame through playback. Only available when the **Synchronous playback** option is not checked.

 **Synchronous playback:** Click to play the selected channel at the same time at the same time.

 Click upon one of the channels which is being played and then click record button to record current video to your computer. Click again to stop recording.

 Click upon one of the channels which is being played and then click capture button to take a snapshot and save to your computer.

 Opens the Download menu, which allows you to download several video recordings at once.

	<input type="checkbox"/>	Start Time	End Time	Status	File Size
1	<input type="checkbox"/>	2021-02-20 00:00:00	2021-02-20 00:06:01	Not Downloaded	180.91M
2	<input type="checkbox"/>	2021-02-20 00:06:01	2021-02-20 00:14:28	Not Downloaded	253.81M
3	<input type="checkbox"/>	2021-02-20 00:14:28	2021-02-20 00:22:58	Not Downloaded	253.99M
4	<input type="checkbox"/>	2021-02-20 00:22:58	2021-02-20 00:31:24	Not Downloaded	253.73M
5	<input type="checkbox"/>	2021-02-20 00:31:24	2021-02-20 00:39:49	Not Downloaded	253.62M
6	<input type="checkbox"/>	2021-02-20 00:39:49	2021-02-20 00:48:19	Not Downloaded	253.86M
7	<input type="checkbox"/>	2021-02-20 00:48:19	2021-02-20 00:56:49	Not Downloaded	253.90M
8	<input type="checkbox"/>	2021-02-20 00:56:49	2021-02-20 01:05:18	Not Downloaded	253.83M
9	<input type="checkbox"/>	2021-02-20 01:05:18	2021-02-20 01:13:44	Not Downloaded	253.55M
10	<input type="checkbox"/>	2021-02-20 01:13:44	2021-02-20 01:22:10	Not Downloaded	253.46M
11	<input type="checkbox"/>	2021-02-20 01:22:10	2021-02-20 01:30:36	Not Downloaded	253.67M
12	<input type="checkbox"/>	2021-02-20 01:30:36	2021-02-20 01:39:06	Not Downloaded	253.98M
13	<input type="checkbox"/>	2021-02-20 01:39:06	2021-02-20 01:47:35	Not Downloaded	253.62M
14	<input type="checkbox"/>	2021-02-20 01:47:35	2021-02-20 01:56:01	Not Downloaded	253.58M

14 Row / Page 1 / 14Page

Choose the files you want to download, press [Start Download](#) button to begin, you will see the download status. Press [Stop Download](#) button to stop.

 **Playback Speed:** Click to choose the playing speed.

 **Play All Channels:** Click to play all channels you have chosen to searched. Only available when the [Synchronous playback](#) option is not checked.

 **Stop All Channels:** Click to stop playing all channels. Only available when the [Synchronous playback](#) option is not checked.

 **Digital Zoom:** Click upon on a playing video, then click -and-drag over an area of the video to enlarge. Right-Click to return to the normal display.

 **Original Proportions:** Shows the playing video at the original proportions.

 **Stretch:** Stretch the playing video to fit the full area for each channel on screen.

 To enlarge the web client to full screen.

### 8.3.2.2 Picture playback

After setting the capture in [5.2.3.1 Capture](#) After setting the capture in [5.2.3 Capture](#), you can search the captured image here.

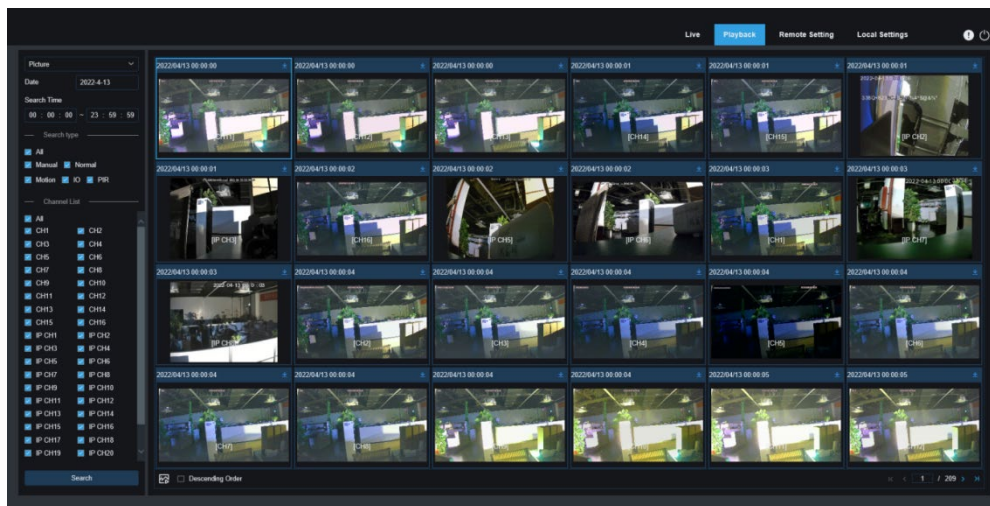

#### Search capture:

1. Click playback in the upper right corner of the window.
2. Select picture from the drop-down menu in the upper left corner.
3. Select a day to search on the calendar. The date with the snapshot is underlined in red.
4. Select the image type to search from the list in the search type menu, or select all to search all types.
5. Check the channel to search for videos.
6. Click Search.
7. The picture that meets your search conditions will be displayed on the right side

You can double-Click any picture to enter the small fragment back interface, click  to return to the previous page.

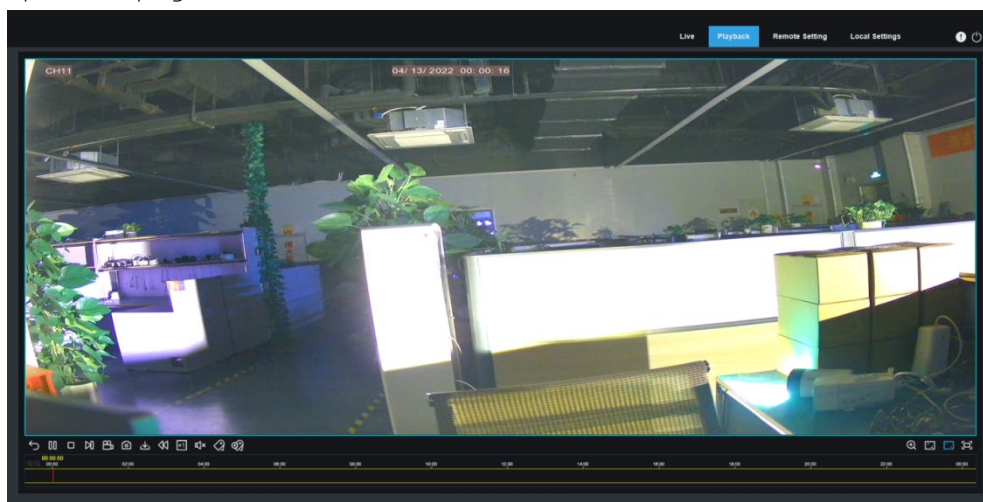

### 8.3.2.3 Tag playback

In this menu, you can view all the tags that have been added.

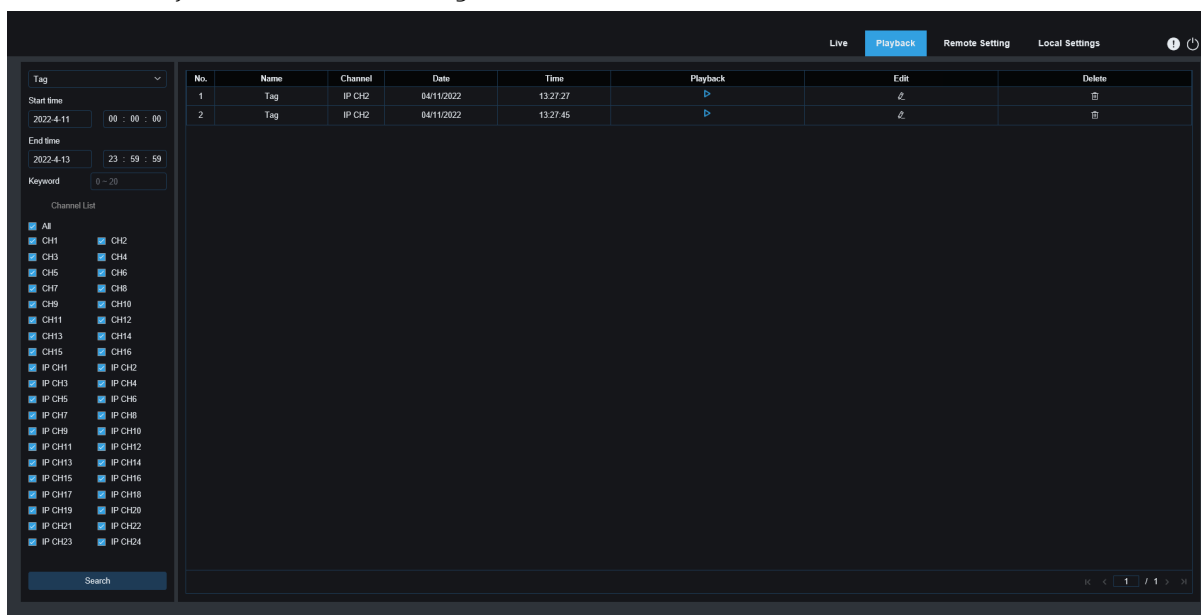

Please view [7.1.5 Tag playback](#).

### 8.3.2.4 Smart playback

On [5.1.6 Motion](#) set up motion detection, human triggering motion detection alarm, you can find Smart Pickled Played Video.

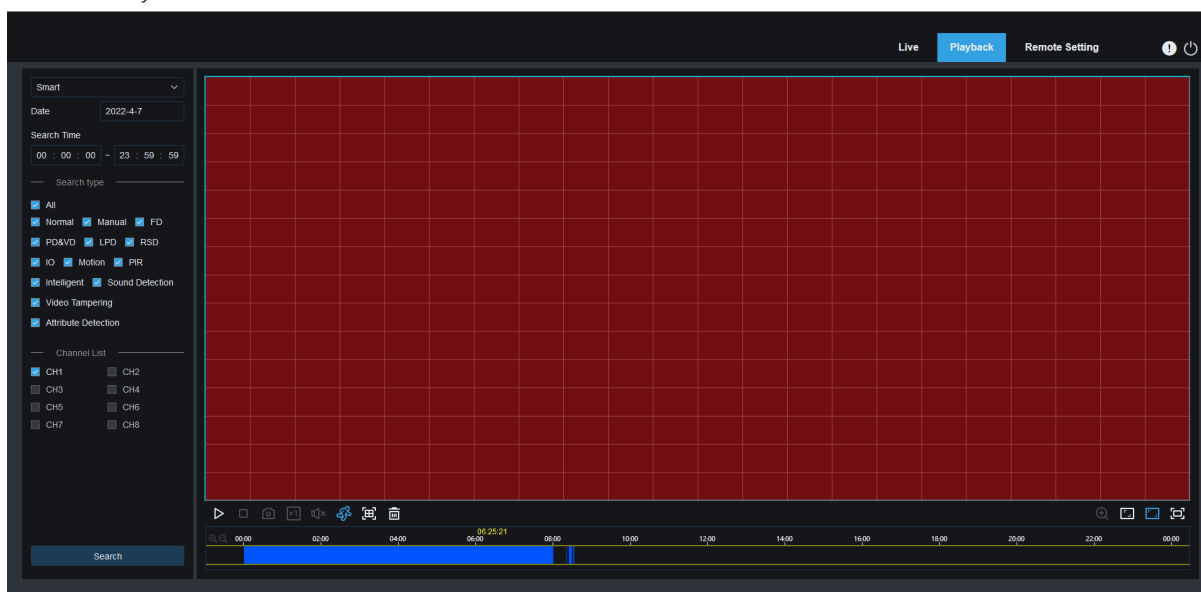

Click  button to show smart set up area, click  button to select all area. Click  to delete all selected area.



## 8.3.4 Local Setting

Set download locations for recordings and snapshots taken using Web Client, and choose file type for video files.

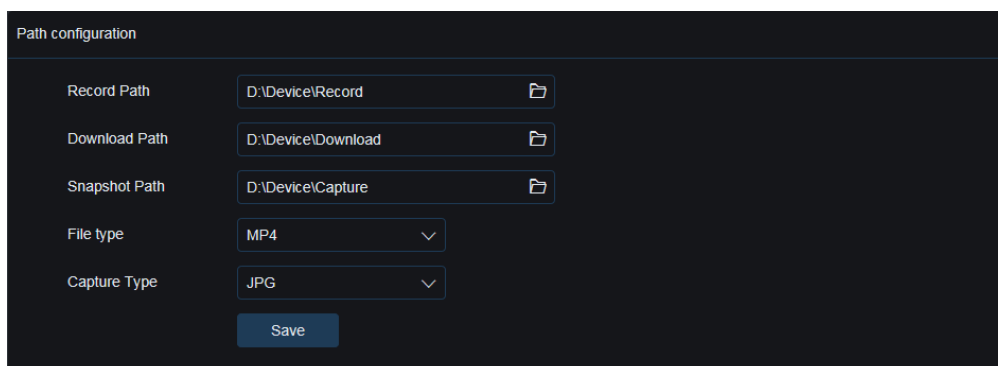

The screenshot shows a 'Path configuration' window with a dark background. It contains five rows of settings:

- Record Path:** A text input field containing 'D:\Device\Record' and a folder icon to its right.
- Download Path:** A text input field containing 'D:\Device\Download' and a folder icon to its right.
- Snapshot Path:** A text input field containing 'D:\Device\Capture' and a folder icon to its right.
- File type:** A dropdown menu with 'MP4' selected and a downward arrow.
- Capture Type:** A dropdown menu with 'JPG' selected and a downward arrow.

At the bottom center of the window is a blue 'Save' button.

**Record Path:** Click  to browse for and select the folder where you would like the manual video recordings to be saved on your computer.

**Download Path:** Click  to browse for and select the folder where you would like to save the download video recordings to your computer.

**Snapshot Path:** Click  to browse for and select the folder where you would like the manual capture snapshots to be saved on your computer.

**File Type:** Choose your preferred file type for manual recordings.

**Capture Type:** Choose your preferred file type for manual capture.

**Save:** Click to save the modifications.

## Chapter 9 Viewing Backed Up Video on PC/Mac

This section will help you to play the backup files with the powerful video player which is attached in the CD.

For Mac users, please install the app "VideoPlayer\_x.x.xx\_xxxx\_xx\_x.dmg" , for example:

VideoPlayer\_1.0.15\_2017\_01\_6.dmg.

For PC users, please install the software "VideoPlayer\_x.x.xx\_xxxx\_xx\_xx.exe" , for example:

VideoPlayer\_1.0.15\_2017\_01\_06.exe.

### Minimum System Requirements

- Intel Pentium 4 or above
- Microsoft Windows XP / Vista / 7 / 8 / 10
- 256MB RAM
- 16MB video memory

1. Install the Video Player software in the CD and run.

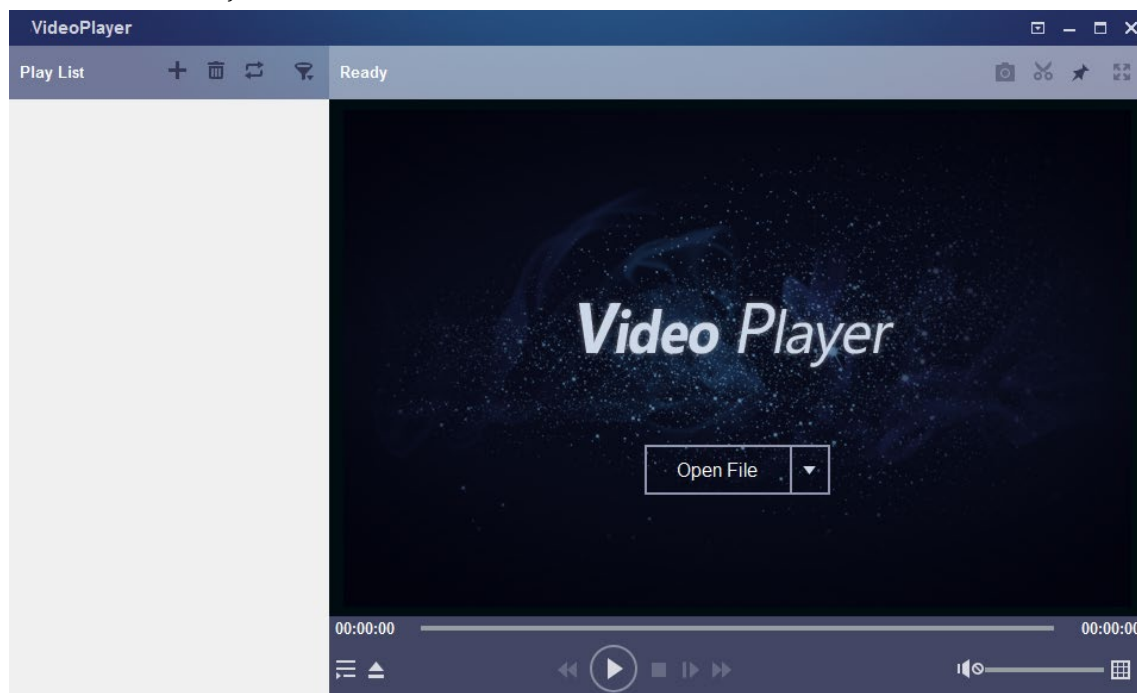

2. Copy the backup files to your computer.





Click **Open File** button or Click **+** button on the Play List to load single or multiple video files. It supports to add & play “.rf” , “.avi” , “.mp4” , “.264” and “.265” files. Click **▼** button to load a folder with backed-up videos.

## Video Player Control











### 1. Play List

-  Add files
-  Remove files
-  To choose play mode: play a single file and stop. play all listed files by sequence. repeat one file. repeat all files.
-  Filter by file name

### 2. Hide/Show Playlist

-  Click to open files or load a folder.



### 3. Play Controls

-  Play
-  Pause
-  Stop
-  Play frame by frame. Click once to play a frame of the video
-  Slow Play, 1/2, 1/4 and 1/8, 1/16 speed
-  Fast Forward, x2, x4, x8 and x16

### 4. Volume control

-  Multi-screen play. It allows to play multiple videos at a time. When you choose multi-screen, you can drag the video in Play List to the play screen.

### 5. Take snapshot

-  To save a video clip to your computer. Press once to start, press again to end the video clip.
-  Keep the video player on top
-  Enlarge the video play screen to full screen

### 6. **Advanced Setup Menu** allows to choose the OSD language of the video player, and configure the setting of video player.

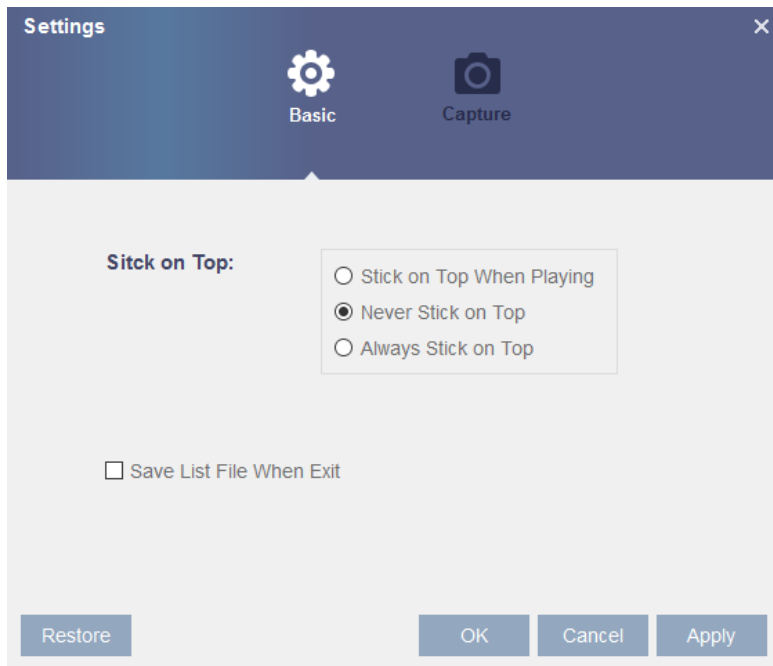

Basic Settings: Set on-top mode

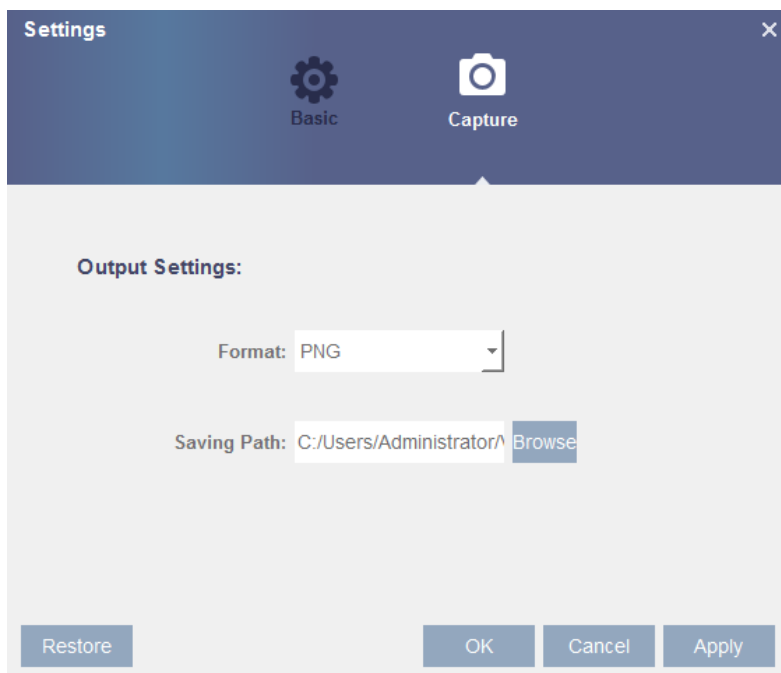

Capture Settings: Set the format and the path to save snapshots.

# Chapter 10 Appendix

## 10.1 Troubleshooting

1. Q: What can I do if the system does not detect the HDD?

A: Check if the power supply system is properly connected and data cord and power cables are securely connected, and if something wrong with the HDD interface. Or you may check if your HDD is supported by referring to the specifications or descriptions.

2. Q: I have changed the password but forget the new password, how can I access the system?

A: If you forget system password, please consult with our technical personnel. We strongly suggest user to set password easy to be remembered and relatively safe. If you have safety requirement, please do not set very simply password, such as 000000.

3. Q: We see abnormal video signal or even no video signal by connecting the DVR and camera together. Power supply for both devices is OK. What is wrong?

A: Check network cable at DVR side to see if the cable is firmly connected and if it is worn out and needs to be replaced, or to check if NTSC or PAL is selected consistently.

4. Q: How to prevent DVR from being influenced by heat?

A: The DVR needs to dissipate heat while it is running. Please place the DVR in a place with good air circulation and away from heat sources to ensure stability and life of the DVR.

5. Q: The remote controller of DVR doesn't work while the monitor screen is OK and panel keys are functional. Why?

A: Operate again by aiming the remote controller at the IR receiver on front panel. If it still doesn't work, please check if the batteries in the remote controller are dying. If not, check if the remote controller is broken.

6. Q: I want to take out HDD from my PC and install it in DVR. Can it work?

A: All HDDs supported by the system can be used. But remember, once DVR runs, the data on your HDD will be lost.

7. Q: Can I playback while recording?

A: Yes. The system supports the function of playing while recording.

8. Q: Can I clear some records on HDD of DVR?

A: In consideration of the file security, you may not clear part of records. If you want to remove all the records, you can format HDD.

9. Q: Why can't I log in DVR client?

A: Please check if the network connection settings are correct and RJ-45 port is with good contact. And check if your account and password are correctly input.

10. Q: Why can't I find any records during playback?

A: Please check if the data line connection for HDD is OK and system time is properly adjusted. Try a few times and restart. If it still doesn't work, check if the HDD is broken.

11. Q: Why DVR cannot control PTZ?

A: Please check if:

- a) PTZ in the front side is malfunctioned.
- b) Setting, connection and installation of PTZ decoder are not correct.
- c) PTZ setting of DVR is not correct.
- d) Protocol of PTZ decoder does not match that of DVR.
- e) Address of PTZ decoder does not match that of DVR.
- f) If many decoders are connected, the farthest side of AB line of PTZ decoder should be added 120Ω resistance to realize reflection suppression and impedance matching. Otherwise, PTZ control will be unstable.

12. Q: Why doesn't dynamic detection work?

A: Please check if the motion detection time and motion detection regional setting are correct and if the sensitivity is set too low.

13. Q: Why doesn't alarm work?

A: Please check if the alarm setting, alarm connection and alarm input signals are correct.

14. Q: Why does buzzer keep alarming?

A: Please check the alarm setting, check if motion detection function is enabled and object motion is detected all the time and if I/O alarm is set as Always Off. Besides, refer to corresponding HDD alarm setting.

15. Q: Why can't I stop recording by pressing "STOP" button or Click "Stop Recording" in context menu?

A: Pressing Stop or Stop Recording can only stop manual record. If you want to stop Scheduled recording in certain time quantum, please change the setting to No Record. To stop Startup recording, please change record mode to scheduled recording or manual recording. Then you may stop recording by the prescribed methods. And another way of stopping recording is to set channel as off status in record setting.

## 10.2 Usage Maintenance

1. To shut down DVR, please firstly shut down the system and then turn off the power. Do not turn off the power directly or HDD data will be lost or damaged.
2. Please keep DVR away from heat sources or places.
3. Clean the internal dust regularly. Make sure the good ventilation of DVR so as to ensure the good heat dissipation.

4. Please do not hot plugging audio and video cables, or cables connected to ports like RS-232 or RS-485. Otherwise the ports will be damaged.
5. Please check the HDD cable and data cable regularly to see if they are ageing.
6. Please prevent the audio and video signals of DVR from being intervened by other electronic devices, and prevent the HDD from being damaged by static electricity and induced voltage. If the network cable is frequently plugged, it is suggested to replace connecting line regularly, or the input signal may be unstable.
7. This is a class of product. It maybe bring wireless interference in life. Under this situation, it need user to make measures.

### 10.3 Accessories (For reference only)



**USB mouse**



**Power Adapter**



**Warranty Card**

#### CAUTION

RISK OF EXPLOSION IF BATTERY IS REPLACED BY AN INCORRECT TYPE

DISPOSE OF USED BATTERIES ACCORDING TO THE INSTRUCTIONS

# CONCORD

[www.concordconnect.com.au](http://www.concordconnect.com.au)