

digitech

Metal Detector with Waterproof Coil



Model:
QP2308

Instruction Manual

Thanks for choosing our metal detector. With this metal detector, you can hunt for coins, relics, jewelry, gold, and silver just about anywhere. The detector comes with high sensitivity and strong ability of discrimination. It is versatile and easy to use.

The detector's features include:

LCD Display: Shows the probable type of metal, the depth of the target, range of DISC, the level of SENS, and battery condition. It also has digital display for target ID.

Three Tone Audio Discrimination: Sounds three distinctive tones (high, medium and low) for different types of metal.

Seven Controls:

--**POWER:** Turns on or off the power.

--**VOLUME/BACKLIGHT:** Short press for adjusting volume level. Press it for about 2 seconds to turn on the backlight.

--**MODE:** Press it to select desired operation mode. There are four modes to be selected from MODE indicator on LCD.

--**INCREASE (+):**To increase the level of volume, sensitivity and the range of discrimination working with VOLUME, SENS and DISC.

--**DECREASE (-):**To decrease the level of volume, sensitivity and the range of discrimination working with VOLUME, SENS and DISC.

--**SENS:** Adjusts the level of sensitivity working with "+" or "-" control button.

--**PP:** Pinpoints the location of the target accurately.

Headphone Jack: Lets you connect headphones of 3.5mm and operate without trouble.

240mm Waterproof Search coil: Lets you use the detector even if you must put it under shallow water.

Adjustable Shaft: Lets you adjust the length of shaft for comfortable use.

Power: The detector requires two 9-volt alkaline batteries (not incl.).

ASSEMBLING THE DETECTOR

Assembling your detector is easy and requires no special tools. Just follow these steps:



1. Unscrew the fixing knob on the lower stem and remove the knob connector. Place the washers into the groove of the lower stem. Then insert the stem and align the holes on the search coil bracket and the stem. Push the connector through the holes and tighten the knob.

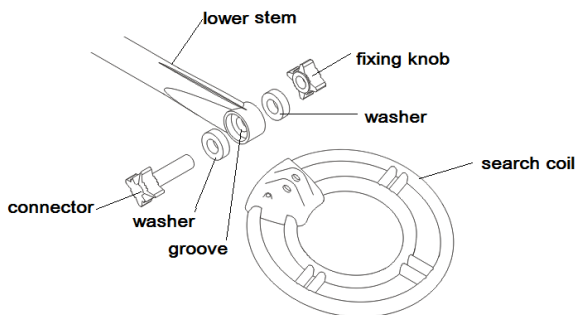

2. Press the silver button in the lower stem, and slide the stem into the middle stem.

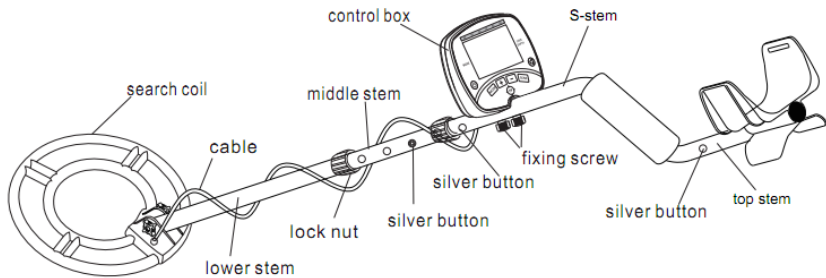

3. Press the silver button in the middle stem, and slide the stem into the S stem. Tighten the lock nut on the S stem.
4. Press the silver button in the top stem, and slide the top stem into the S stem.
5. Adjust the stem to a length that you feel comfortable when you stand upright with the detector in your hand, and the search coil is level with the ground with your arm relaxed at your side. Then counter-clockwise rotate to tighten the lock nut on the middle stem.
6. Fix the control box on the S stem and tighten the fixing screw properly. Wind the search coil cable around the stem. Insert the search coil's cable plug into the five-pin jack at the back of the control box.

Caution:

- Do not over-tighten the search coil or use tools such as pliers to tighten it.
 - The search coil's plug fits into the connector only in one way. Do not force the plug and do not pull on the cable or you could damage it.
7. Stand and stretch your arm, holding the metal detector to make the search coil above the ground for about 1 to 5 cm. Rotate the stem's lock nut counterclockwise to tighten it.

INSTALLING THE BATTERIES

1. Turn off the power before installing the batteries.
2. Slide the battery cover off in the direction of the arrow.
3. Place two 9V alkaline batteries into the battery compartment matching the polarity symbols (+ and -) marked inside.

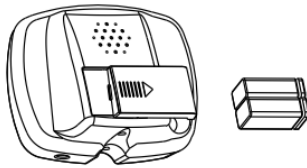

Note: The detector will maintain full performance until the batteries need to be replaced. Replace batteries when there is no segment remaining on battery level indicator. Alkaline batteries should be used.

Warning:

- Dispose of old batteries properly. Never bury or burn them.

Cautions:

- Use only fresh alkaline batteries of required size.
- Do not mix the old and new batteries or different types of batteries.
- If you don't plan to use the detector for a week or more time, remove the batteries. Batteries can leak chemicals that can destroy electronic parts.

USING HEADPHONES

1. It is recommended to choose the headphones with volume control.
2. Insert the headphones' 3.5mm plug into the headphone jack at the bottom of the control box. At this time the internal speaker disconnects.

CONTROL PANEL

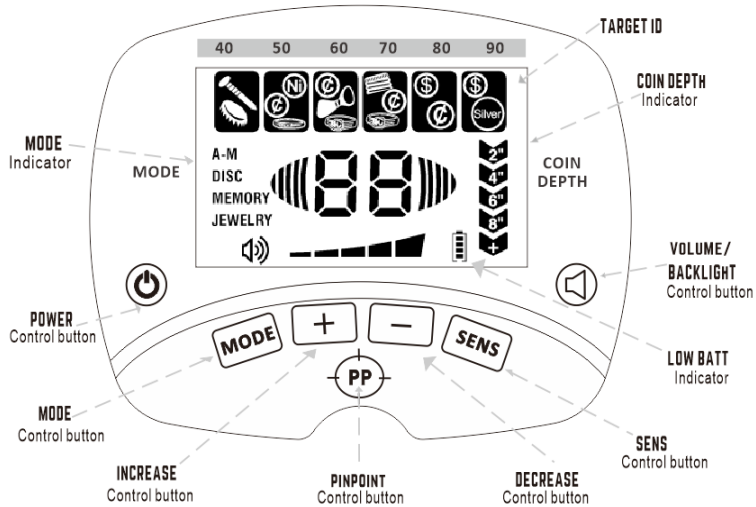

1. LCD DISPLAY

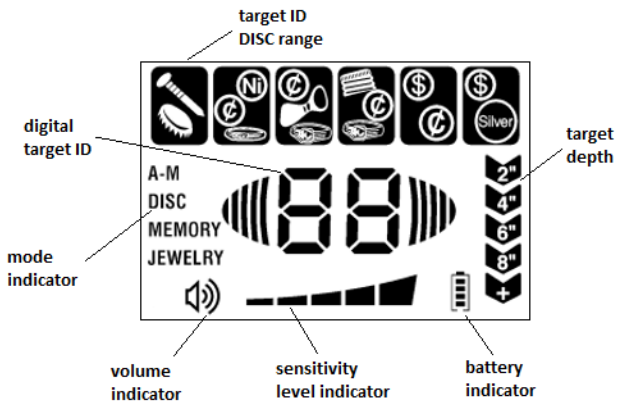

2. CONTROL BUTTONS

POWER : Press the button to power on the detector. Press it again to power off the detector.

VOLUME/BACKLIGHT : Short press for adjusting volume level. Press

it for about 2 seconds to turn on the backlight. Long press again to turn off the backlight.

Note: As the backlight consumes more power, it's better to turn off it in light places.

MODE  : There are four modes to be selected from MODE indicator on LCD.

SENS  : Used to adjust sensitivity level. Press SENS, then press + or - button to increase or decrease the sensitivity. The level will be displayed on the LCD.

INCREASE (+)  : To increase the level of sensitivity and the range of discrimination working with SENS and DISC.

DECREASE (-)  : To decrease the level of sensitivity and the range of discrimination working with SENS and DISC.

PP  : Pinpoints the location of the target accurately.

SEARCH MODES

The detector includes four search modes: A/M (ALL METAL), DISC (DISCRIMINATION), MEMORY, JEWELRY. Select the mode that suits the targets you hope to find.

- **A/M (ALL METAL) Mode**

This mode is designed to detect all types of metal.

- **DISC (DISCRIMINATION) Mode**

The DISC mode can eliminate the unwanted metal targets and works with “+”.

- **MEMORY**

The detector is designed to detect the only memorized metal target.

- **JEWELRY Mode**

This does not mean that the detector will search only for jewelry while in

JEWELRY Mode. It simply indicates that the discrimination pattern is optimized for locating most jewelry items. The JEWELRY mode will still find coins, relics and other non-jewelry items. It ignores most nails and small iron pieces automatically.

OPERATION

Step 1. Turning on the detector

Press **POWER** button to turn on the detector.

After about 2 seconds the detector enters into stand-by state. LCD displays four modes indicator, SENS level, and battery level.

Note: If no button is pressed or no target is detected within about 15 minutes, the detector will turn off automatically.

Step 2. Testing and using the detector

To learn how the detector reacts to different metals, you should test it before you use it the first time. You can test the detector indoors and outdoors.

Indoor Testing and Use

1. Press power button to turn on the detector.

2. Setting the operation mode

(1) **A-M (ALL METAL)** mode:

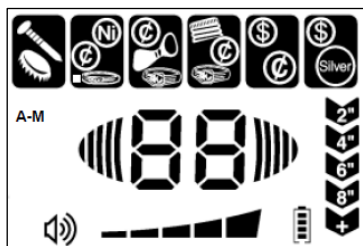

Press MODE to select **A-M** (ALL METAL) mode. **A-M** is displayed on LCD. This means ALL METAL mode is selected. You can detect all kinds of metal.

(2) **DISC (DISCRIMINATION)** Mode

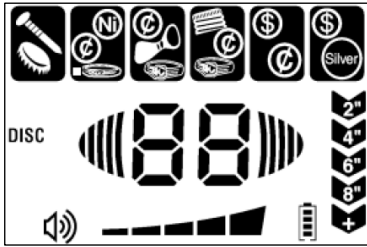

The DISC mode can eliminate the unwanted metal target(s) and works with “+”.

- a. Press MODE to select **DISC**. **DISC** is displayed on LCD. This means **DISC** mode is selected.
- b. Press “+” to eliminate the unwanted target(s) in sequence from left to right. The eliminated target icon(s) will disappear on LCD. The detector will not detect such target(s).

User can select several targets to be eliminated by using **DISC** mode. But silver target such as one dollar coin or 25 cent can’t be eliminated. Because they are valuable.

- c. To pick up the eliminated target ID, simply press “-” and the recovered target icon(s) will be displayed again on LCD.

(3) MEMORY Mode



Press MODE to select **MEMORY**. **MEMORY** is displayed on LCD. This means **MEMORY** mode is selected.

This mode is designed to detect the only memorized metal target. For example, if you want to find 1cent coin, sweep a sample of 1cent over the search coil. The detector will memorize the target. LCD only displays the

memorized target icon and other target icons will be removed. In this case the detector will only detect 1cent coin and will have no response to other metal targets.

(4) JEWELRY Mode

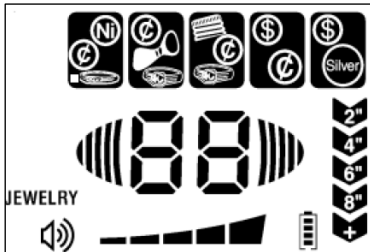

Press MODE to select **JEWELRY**. **JEWELRY** is displayed on LCD. This means **JEWELRY** mode is selected.

The JEWELRY mode is designed to find jewelry such as rings, bracelets, necklaces. It also can find coins, relics and other non-jewelry items. It ignores most nails and small iron pieces automatically. Iron target ID will not appear on LCD. In this mode, the detector will not respond to iron. If you don't want to detect iron, you can use JEWELRY mode for detection.

Step 3. Adjusting sensitivity

Press SENS, then + or – to increase or decrease the sensitivity.

Step 4. Place the detector on a wooden or plastic table, then remove any watches, rings, or metal jewelry you are wearing.

Step 5. Adjust the search coil so the flat part points towards the ceiling.

Note:

Never test the detector on a floor inside a building. Most buildings have metal of some kind in the floor, which might interfere with the objects you're testing or mask the signal completely.









Step 6. Slowly sweep a sample of the material you want the detector to find (such as a gold ring or a coin) 2-3 inches or more above the face of the search coil. When the detector detects any metal, it sounds a tone and the target icon will flash. Also LCD displays the digital value of target as well as the depth of it. Please note that the depth is only a reference.

Note:

If you are using a coin, the detector will detect it more easily if you hold it so a flat side is parallel with the flat side of the search coil. A sweep with the side of coin over search coil might cause false indication and unstable display of target.

TARGET INDICATIONS

Target	Iron	5 cent Nickel Jewelry	Pull tab Jewelry	1cent/zinc S-caps Jewelry	10 cent Copper coin	25 cent Silver coin
Tone	Low	Low	Medium	Medium	High	High
ID Display	 (flash)	 (flash)	 (flash)	 (flash)	 (flash)	 (flash)
Digital value	1-40	41-55	56-65	66-75	76-85	86-99

Note: There is a wide variety of metals and no target can be identified for certain until unearthed. This table is for general reference only.

OUTDOOR TESTING AND USE

Step 1. Press power button to turn on the detector.

Step 2. Follow the step 2 described in section of **Indoor Testing and Use** to set the operating mode.

Step 3. Follow the step 3 described in section of **Indoor Testing and Use** to set the level of sensitivity.

Note:

In order to detect the target deeply buried, you can adjust the SENS to a high level. But not to set the level of SENS to Max. level, or the detector will receive interference and false signal from broadcast antenna and other electrical lines. The detector will have unstable and irregular indications.

Step 4. Find an area on the ground outside where there is no metal.

Step 5. Place a sample of the material you want the detector to find (such as a gold ring or a coin) on the ground.

Note:

If you are using valuable metal such as gold to test the detector, mark the area where you place the item, to help you find it later. Do not place it in tall grass or weeds).

Step 6. Hold the search coil level to the ground about 1~2 inches above the surface, slowly move the search coil over the area where you placed the sample, sweeping the search coil in a side-to-side motion.

- Never sweep the search coil as if it were a pendulum. Raising the search coil while sweeping or at the end of a sweep will cause false readings.

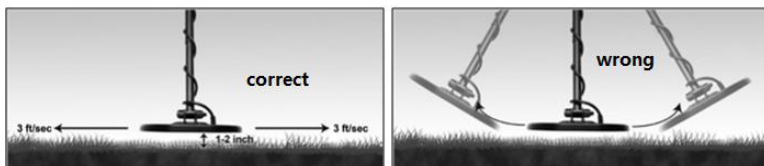

- Sweep slowly, hurrying will cause you to miss targets.
- It's better you sweep the search coil from side to side in an arc line of 3 inches motion and keep the search coil parallel with the ground

If the detector detects the item, it sounds a tone, and the target icon flashes. Also LCD displays the digital value of target as well as the depth.

If the detector does not detect the item, make sure that the mode is set correctly for the type of metal you're searching for. Also make sure that you're moving the search coil correctly.

Notes:

- The detector responds with a signal when it detects most valuable metal objects. If a signal does not repeat after you sweep the search coil over the target a few times, the target is probably junk metal.
- False signals can be caused by trashy ground, electrical interference, or large irregular piece of junk metal.
- False signals are usually broken or non-repeatable.

Using BACKLIGHT

In dark area, you can use BACKLIGHT for better searching. Press **VOLUME/BACKLIGHT** button for about 2 seconds to turn on the backlight. Long press it again to turn the light off.

Note:

- To save power, the backlight will turn off automatically after 10 minutes.
- As the light consumes more power, it's better to turn off the backlight in normal environment.

PP (PINPOINT)

After you find a metal object, you can use PP to pinpoint the target.

- (1) Press PP button, "PP" on LCD flashes. When LCD displays steady "PP", you can start to move the search coil slowly above the sound area. If the detector finds the target, it sounds a tone. Also the digital value of the target and depth are displayed on LCD.
- (2) Press PP button again. After steady "PP" displays, sweep the search coil, keeping the same distance of search coil, sound disappears. Closer the search coil to the sound area, the detector sounds again.

Repeat the above steps until the detector displays the constant signal where the location of the target is.

FACTORS THAT AFFECT THE DETECTING

It's difficult to have an accurate detecting result. Sometimes the detecting may

be restricted by some factors:

- The angle of the target buried in the soil.
- The depth of the target.
- The level of oxidization of the target.
- The size of the target.
- Electro-magnetic and electrical interference surrounding the target.

In area of highly mineralized ground, or fertile ground, or wet sand, the detector will sound even if there is no metal. In this case, you can lower the sensitivity.

Meantime enhance the distance between the search coil and the ground.

Metallic digging tools will also affect the detection if they are near the search coil. So it's better place them a little far away.

Troubleshooting Guide

Problem	Reason	Suggestion
The detector displays or sounds without detecting any target	<ol style="list-style-type: none"> 1. The detector may receive interference and false signal from broadcast antenna and other electronic lines 2. The humidity of environment may be extremely high 	<ol style="list-style-type: none"> 1. Change searching place 2. Wait for some time to check again
The detector sounds false signals.	<ol style="list-style-type: none"> 1. Sensitivity set too high/ environmental electromagnetic interference 2. Sweeping the detector's search coil too fast or at wrong angle 3. Using 2 detectors in close proximity 	<ol style="list-style-type: none"> 1. Reduce sensitivity 2. Sweep the search coil more slowly and hold the detector correctly 3. Keep two detectors at least 6 meters(20') apart
The detector does not detect anything	<ol style="list-style-type: none"> 1. Sensitivity set too low 2. Target range is eliminated 3. Search coil is not parallel to the ground 	<ol style="list-style-type: none"> 1. Increase sensitivity 2. Recover all target range 3. Adjust the search coil angel to be parallel to the ground
LCD display multiple target categories or emits several sounds at once	<ol style="list-style-type: none"> 1. There may be over one kind of metal targets 2. The detector can't identify the target. Sometimes, oxidized metal also causes the excursion of target arrow and tone. 	<ol style="list-style-type: none"> 1. Reduce the sensitivity to eliminate the detection of the deeper target 2. Sweep the search coil with different angles
The detector does not function.	<ol style="list-style-type: none"> 1. Five-pin cable not connected well 2. Dead battery 	<ol style="list-style-type: none"> 1. Re-plug it properly 2. Replace batteries

Distributed by:
Electus Distribution Pty Ltd
46 Eastern Creek Dr,
Eastern Creek NSW 2766 Australia
Ph 1300 738 555
Int'l +61 2 8832 3200
Fax 1300 738 500

www.electusdistribution.com.au