

POWERTECH

MB4108

5040Wh Power Station



Instruction Manual

CONTENTS

Warnings & Safety Information	3
Before First Use	4
Box Contents	4
Product Diagram.....	5
LCD Screen Description	6
Usage Instructions.....	6
Charging Instructions	8
Other Functions	13
FAQ	14
Error Codes.....	15
Maintenance	17
Specifications.....	17
Warranty Information.....	18

WARNINGS & SAFETY INFORMATION

WARNING: The manufacturer is not responsible for any potential injury from misuse

- Read this user manual carefully before using the product to ensure that you completely understand the product and can correctly use it. After reading this user manual, keep it properly for future reference.
- Improper use of this product may cause serious injury to yourself or others, or cause product damage and property loss. Once you use this product, it is deemed that you understand, approve and accept all the terms and content in this document.
- In compliance with laws and regulations, the Company reserves the right to final interpretation of this document and all documents related to this product. This document is subject to changes updates, revisions, or termination) without prior notice. Please visit the official website to obtain the latest product information.
- No compensation for losses caused by the use of non-standard connectors.

BEFORE FIRST USE

Prior to using your product, please read all the safety and operating instructions thoroughly. Please ensure you follow the steps below before using the product. We recommend you keep the original packaging for storing the product when not in use.

Please pay close attention to the section entitled Warnings & Safety Information. Find a safe and convenient place to keep this instruction manual for future reference.

Unpack the product but keep all packaging materials until you have made sure your new product is undamaged and in good working order. Ensure you have all accessories listed in this manual.

BOX CONTENTS

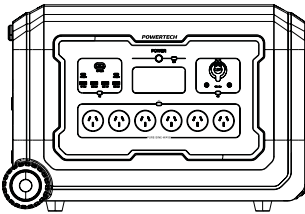

Power Station

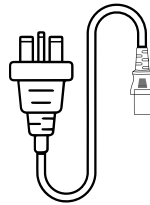

Mains Charging Cable

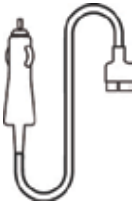

12V Charging Cable

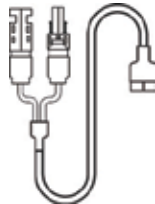

Solar Charging Cable



User Manual

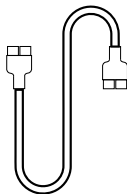

Anderson Cable

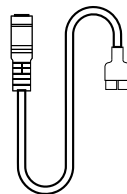

Anderson 7909 Cable

PRODUCT DIAGRAM

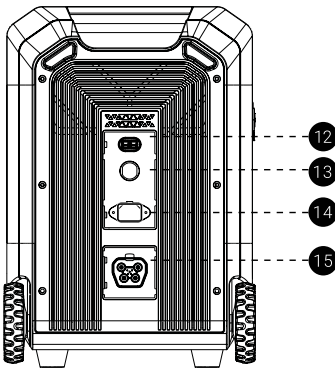
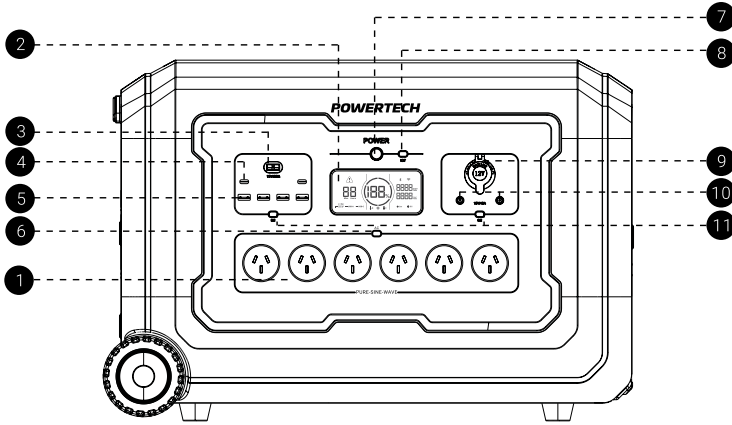

- | | |
|----------------------------------|-----------------------------------|
| 1. AC Output Port (16A Max) | 10. DC 5521 Output Port |
| 2. LCD Screen | 11. DC Output Power On/Off Switch |
| 3. Anderson Output Port | 12. Anderson input port |
| 4. USB-C Output Port | 13. Reset switch |
| 5. USB-A Output | 14. AC input port |
| 6. AC Output Power On/Off Switch | 15. Fuel Pack Connection Port |
| 7. Main Power On/Off Switch | |
| 8. 10T On/Off Switch | |
| 9. 12V Car Charger Output Port | |

LCD SCREEN DESCRIPTION

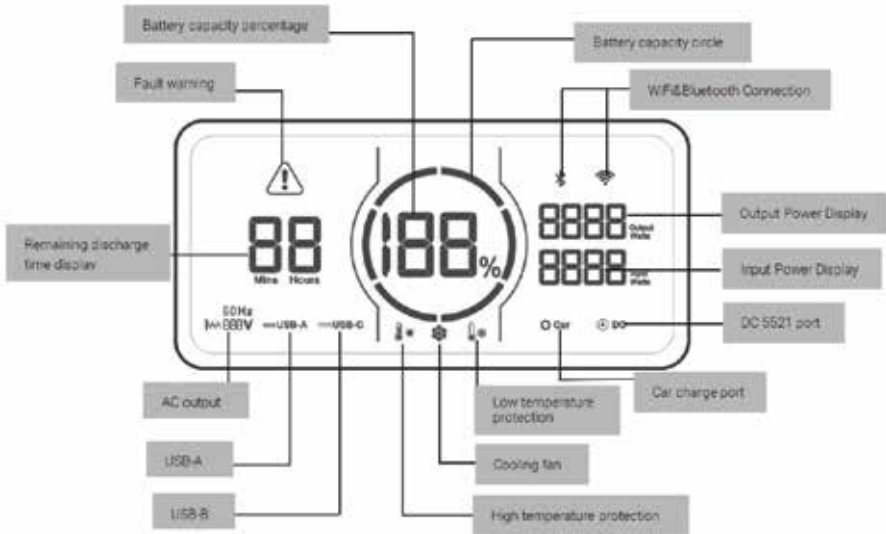

USAGE INSTRUCTIONS

LCD battery capacity circle indicates battery level. The capacity circle is divided into six sections, accounting for approximately 17%~35%~51%~68%~85%~100% of the capacity. When in use, the LCD display automatically wakes up. When discharging, the blue capacity segment disappears from the display, indicating remaining capacity. When charging, the blue battery capacity circle flashes clockwise along the trajectory, which indicates that the device is currently charging. The number on the right side of the energy circle now displays the real-time input power. After full charging, all blue capacity segments will be illuminated and keep in stable. After charging is completed, please unplug the charger.

Press and hold the power button, the product will turn on, the LCD screen will light up, and the power button indicator light will turn to a steady state; press and hold the power button for about 3 seconds or more, the LCD screen will display the word "off" and then release it, the product will shut down, and the LCD display will turn off. When the main power button is turned on, lightly press the switch button of each functional area, and the corresponding function icons on the LCD screen will light up at the same time. At this time, the functions in this area can be used normally; tap the corresponding functional area button again, and the corresponding LCD screen icons will turn off. This area function stops working.

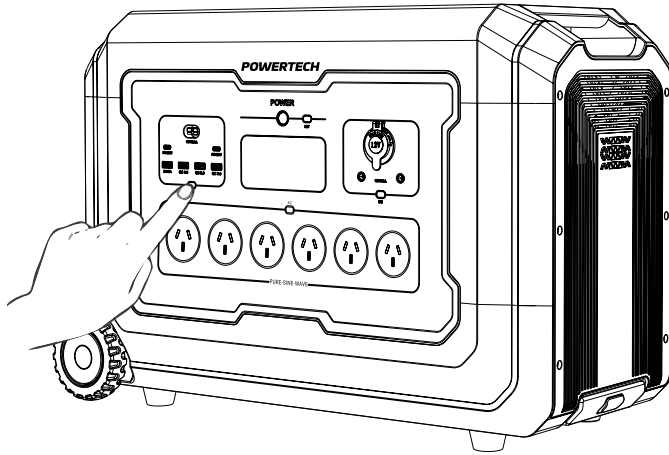

NOTE: After the product is turned on, short press the main power button, the LCD screen will turn off but the product will not be turned off.

NOTE: If the product is not operated within 5 minutes, the product will enter the sleep state and the LCD screen will automatically turn off. When the product has a load change or operation, the LCD screen automatically lights up.

NOTE: The default standby time of this product is 12 hours. If the other output power buttons are not turned on and the product is not connected to any load, the product will automatically shut down after 12 hours, and the standby time can be set on the APP.

CHARGING INSTRUCTIONS

AC Charging

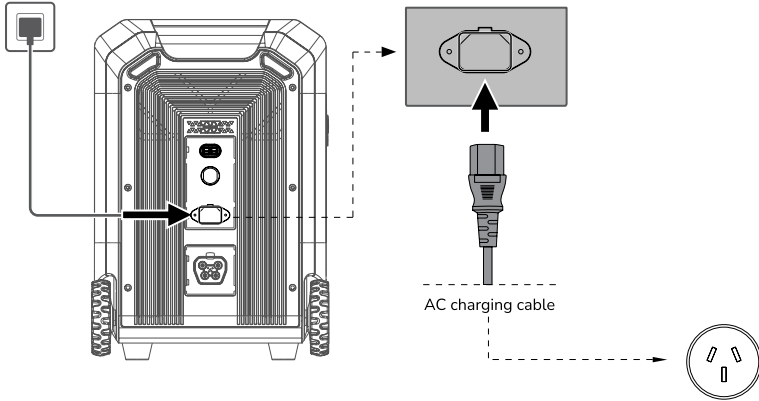

Use the standard AC charging cable to charge the device, connect as shown in the figure, when the input power on the screen shows a reading, the device starts to charge. The maximum fast charge can be 2000W and the device can be fully charged in about 2.8 hours.

NOTE: Please use the AC Charging Cable included in the package for fast charging. Do not use other cables to charge. Plug directly into an AC wall outlet and make sure that the wall output current is more than 10A. Otherwise, reduce the unit charging speed with the AC Charge Speed Switch. The Company takes no responsibilities for any consequences caused by failures to follow instructions, including but not limited to charging with other AC charging cables.

Fast charge & Slow charge function Settings

Note: The product must be turned on, and the input and output ports must be cut off.

1. Long press the DC button +IOT button and hold for 5 seconds, the screen flashes and shows the word "SET", the product enters the input power switching interface, then tap the IOT button to switch, L means slow charge (1000W input), H means fast charge (2000W input);
2. After switching, hold down the POWER button for 3 to 5 seconds to confirm the setting. The screen stops flashing and the word "SUC" will be displayed, which indicating that the setting is successful.
3. Exiting the fast charge/Slow charge switch function, please press and hold the POWER button again for 3-5 seconds.

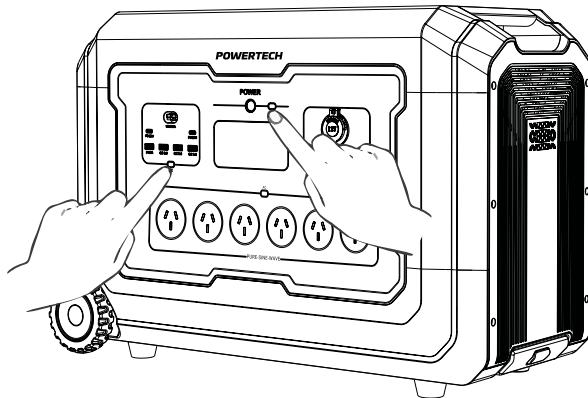

Solar Charging

Connect the standard solar panels to the device by using the fittings "Anderson to MC4 cable" x1 and "MC4 to 7909 cable" x6. Up to 6 standard solar panels can be connected to the device, which takes about 3.5 hours to be fully charged.

NOTE: The solar charging cable (MC4-7909 cable) and solar panel need to be purchased separately.

NOTE: When using the matching solar panel to charge this product, please connect it according to the user manual.

NOTE: Before connecting the solar panel, please confirm that the output open circuit voltage of the solar panel is within 150V to avoid damage to the product.

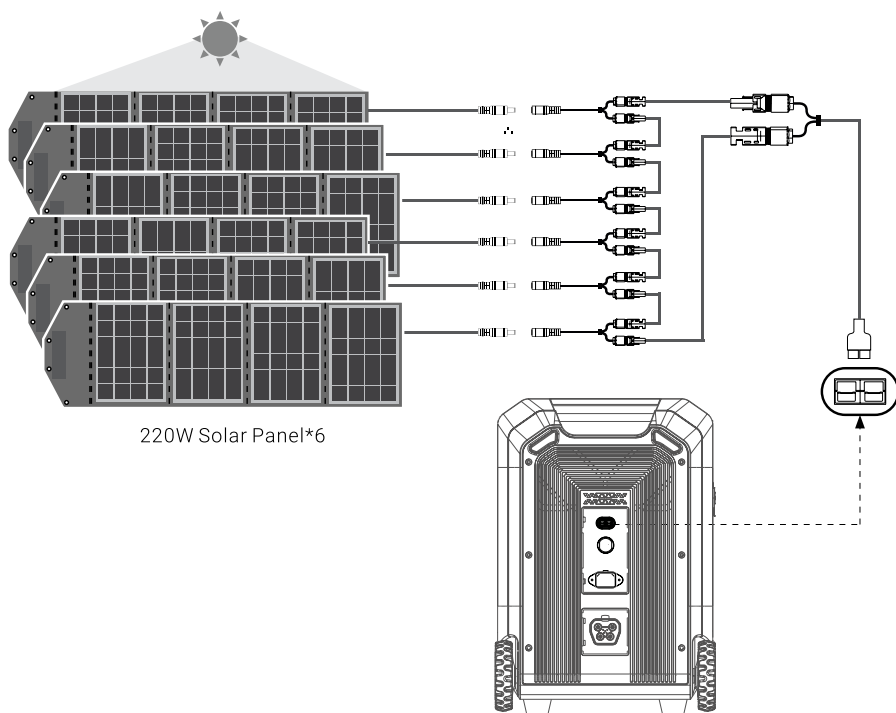

Car Charging

Use the car charger port of the car to charge this product, supporting 12V/ 8A car charging. For protecting the car battery from losing power and unable to start, it is necessary to use the car charger to charge after the car is started.

At the same time, ensure that the car charger port and the cigarette lighter of the car charger input cable are in good connection. The company shall not be held responsible for any loss caused by non-compliance with the standard operation.

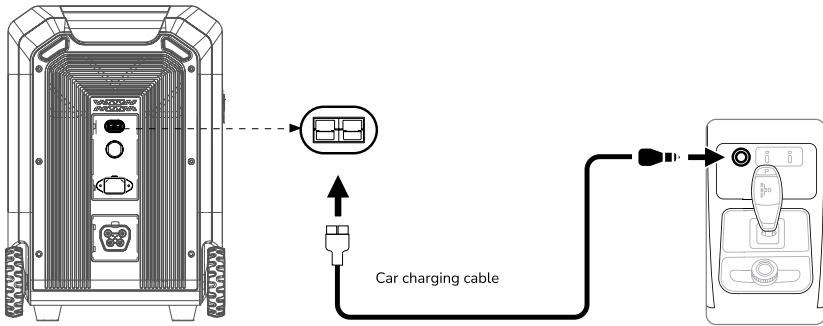

Extended Battery Charging

Power pack(up to one) can be connected to this product. Use the product-specific power pack cable to connect the product and the battery pack, and the device starts to charge when a reading appears on the input power on the screen.

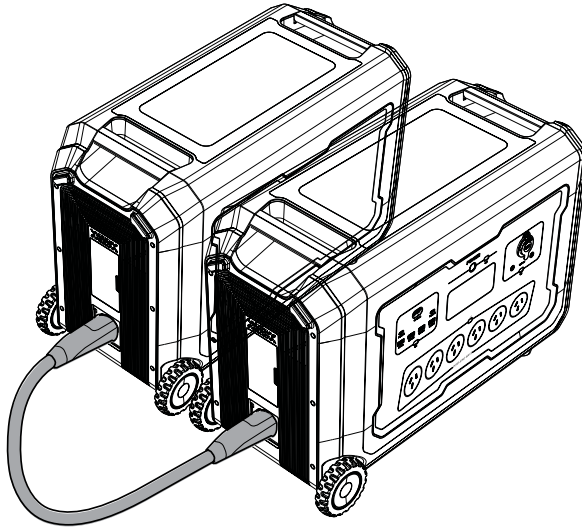

NOTE: Please make sure that both the product and the power pack are turned off before connecting the extended battery to this product.

NOTE: After this product is connected to the extended battery, make sure that the LCD display of this product shows the input power, before turning on.

WARNING: Do not directly connect or remove the power pack during the charging and discharging process. If you need to connect or remove the power pack when using, please turn off the power before operating.

WARNING: Do not use your hands or other objects to touch the metal terminals at the connection port of the power pack. If there are foreign objects attached to the metal terminals, please lightly wipe with a dry cloth.

WARNING: The device only allows to plug in and unplug the battery pack in the shutdown status:with the device on, to plug or unplug battery packs will trigger the overcurrent protection. If damage under this situation,no warranty allowed.

OTHER FUNCTIONS

Circuit Break Protection Function

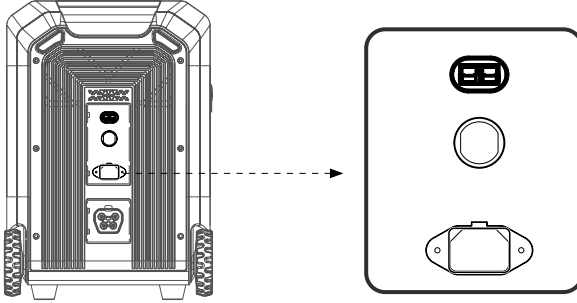

The main function of the circuit breaker is to cut off and connect the load circuit, and cut off the fault circuit to prevent the expansion of the accident and ensure safe operation. In the case of electrical overload or abnormal operation, if a fault occurs, the circuit breaker will automatically disconnect the switch to protect electrical appliances and circuits.

1. Please turn on the AC IN switch when charging by mains electricity.
2. Please turn on the AC OUT switch when loading with AC output, otherwise there will be no output at the AC output port;
3. Please turn on the AC IN and AC OUT switches at the same time if you want to use EPS function (Load takes precedence over charging: charging+load < 2000W).

1. What type of battery does the product use?

This product uses high-quality lithium iron phosphate batteries.

2. What equipment can be connected to the AC output port of the product?

The AC output port of this product has a rated power of 5000W and a peak power of 7000W. It can power most household appliances. However, it is recommended that you confirm the power of the appliance before use and ensure that the sum of the power of all load devices is less than the rated power.

3. How to know how long the product can provide power?

The LCD screen of this product will display the battery life, and devices with stable power consumption can be estimated based on this time.

4. How to tell if the product is charging?

When charging, the LCD screen will display the remaining charging time, and the power indicator circle outside the battery power percentage will begin to rotate in a circular motion, and the input power will be displayed.

5. How to clean this product?

Please use a dry, soft, clean cloth or paper towel to wipe this product.

6. How to store the product?

When storing, please turn off this product first and then store it in a dry, ventilated place at room temperature. Do not place this product near water and fire sources. During long-term storage, it is recommended to charge and discharge the battery every three months to extend the service life of this product.









7. Can this product be brought on board a plane?















No.

8. Is the actual output capacity of the product consistent with the capacity specified in the user manual?

The capacity indicated in the user manual is the rated capacity of the battery pack of this product. Since this product has a certain efficiency loss during the charging and discharging process, the actual output capacity of the product is lower than the capacity specified in the user manual.

ERROR CODES

FAULT CODE	FAULT INFORMATION	STATUS	REMARKS
E000	AC output short circuit protection	Flashing, no output 	Press the AC output power on/off button for recovery
E001	Output overload protection	Flashing, no output 	Flashing icons indicates which circuit overload. Overload protection needs to be restored manually, UPS function overload 3600W 1 sec.
E002	AC Battery low voltage protection	The corresponding function icon flashes and the corresponding port has no output.	After protection, restart corresponding function keys to restore functions, and recharge it timely
E003	AC output over-voltage and low voltage protection	Flashing, no AC output 	You need to manually press the AC power button to recover
E004	Abnormal AC input frequency	Flashing, no output 	Automatically recover when frequency is normal
E005	High and low bus voltage, over-current	Flashing, no output at all ports 	You need to manually press the AC power button to recover
E006	Inverter over-temperature charging over-temperature protection	Flashing, no output 	Temperature lower down to normal level, it will recover automatically
E007	PV input over-voltage and low voltage protection.	No PV charging	Return to normal charging after the photovoltaic input voltage is normal.
E008	12V30A overload short circuit protection	Flashing, no output 	Need to manually press the DC ON/OFF switch to restore
E009	24V auxiliary power overload short circuit alarm	The DC board reports a fault, but does not turn off the output.	Reduce the load on DC port.
E010	Overload and short circuit of the cigarette lighter socket	Flashing, no output 	You need to manually press the DC power button to recover

FAULT CODE	FAULT INFORMATION	STATUS	REMARKS
E011	Overload and short circuit of the USB-A port	Flashing, no output at all ports  	You need to manually press the DC power button to recover
E012	Overload and short circuit of the USB-C port	Flashing, no output at all ports  	You need to manually press the DC power button to recover
E013	Battery low voltage protection when DC discharge	Flashing, no output 	Restart the corresponding function button to restore the function and charge in time
E020	BMS communication failure	Flashing, no output at all ports 	Check BMS communication cable
E021	Battery cell high voltage alarm	E021 code flashing	Set the device aside and wait for the battery voltage to recover automatically
E022	Battery cell low voltage alarm	Battery capacity percentage flashing	Connect the AC charging cable and keep charging until the voltage is normal
E023	Total battery voltage is too high	E23 code flashing but output is normal	Set the device aside and wait for the battery voltage to recover automatically
E024	Total battery voltage is too low	Flashing, no output at all ports 	Connect the AC charging cable and keep charging until the voltage is normal
E025	Battery high temperature	Flashing, no output at all ports  	Automatically resumes after temperature recovery
E026	Battery low temperature	Flashing, no output at all ports  	Automatically resumes after temperature recovery
E027	System overload	Flashing, AC output close, DC output is normal, the AC load is higher than 2100W or AC+DC load is higher than 2100W 	You need to manually press the AC power ON/OFF button to recover
E028	Charging over-temperature	Flashing, charging stop  	Automatically resumes after temperature recovery

MAINTENANCE

1. Please store the product away from water sources, heat sources, and metal objects.
2. In order to extend the service life of the battery, it is recommended to use or store this product in an environment of 20C to 30°C.
3. If long-term storage is required, please charge and discharge this product once every 3 months (first discharge to 0%, then fully charge, then discharge to 60% for long-term storage); products that have not been charged or discharged for more than 6 months warranty will not be provided.
4. For safety reasons, do not store this product in an environment above 45°C or below -10 C for a long time.
5. If the product is seriously low on power and idle for too long, the product will enter deep sleep mode, and the product must be charged before use again.

SPECIFICATIONS

Model		S5
AC Output	Rated Voltage	230VAC
	Rated Power	5000W
	Peak Power	7000W
	Frequency	50Hz (60Hz)
DC 12V & Car Lighter Output	Rated Voltage	12V
	Rated Power	120W
USB-A Output		5V/3A; 9V/2A; 12V/1.5A [18W Max] 5V/2A (Some iPhones are not applicable)
USB-C Output		5V/3A; 9V/3A; 12V/3A; 15V/3A; 20V/5A [60W Max]
Solar Output		12V/30A
AC Charge Input		220~240Va.c 10A 2000W
Solar Input		12~150Vd.c 15A 2100W Max
Rated Capacity		5040Wh
Rated Voltage		48 Vdc
Battery Type		LiFePO4
IP Grade		IP21
Working Temperature		0°C~40°C
Dimension		641.5 x 304.5 x 437.5mm
Net Weight		51kg

WARRANTY INFORMATION

Our product is guaranteed to be free from manufacturing defects for a period of 12 Months.

If your product becomes defective during this period, Electus Distribution will repair, replace, or refund where a product is faulty; or not fit for intended purpose.

This warranty will not cover modified product; misuse or abuse of the product contrary to user instructions or packaging label; change of mind and normal wear and tear.

Our goods come with guarantees that cannot be excluded under the Australian Consumer Law. You are entitled to a replacement or refund for a major failure and for compensation for any other reasonably foreseeable loss or damage. You are also entitled to have the goods repaired or replaced if the goods fail to be of acceptable quality and failure does not amount to a major failure.

To claim warranty, please contact the place of purchase. You will need to show receipt or other proof of purchase. Additional information may be required to process your claim.

Any expenses relating to the return of your product to the store will normally have to be paid by you.

The benefits to the customer given by this warranty are in addition to other rights and remedies of the Australian Consumer Law in relation to the goods or services to which this warranty relates.

This warranty is provided by:

Electus Distribution

Address 46 Eastern Creek Drive, Eastern Creek NSW 2766

Ph. 1300 738 555