

GT4136

# ***R/C Fighter Plane***



***User Manual***

## FEATURES:

- 1) RTF package, including all set of flight equipments. Just spend 2 minutes for easy assemblage and 1 hour for recharging the battery, the airplane is ready to go.
- 2) Designed with high simulation of a real airplane, with perfect structure to guarantee great flight performance.
- 3) Made of high quality EPP material for reliable impact resistance, duration and easy fixing.
- 4) Featured with reasonable design of climbing angle, powerful motors, easy to take-off and excellent gliding performance.
- 5) Equipped with built-in gyroscope to enhance the stability of flight.

## PACKING LIST

Parameter:

Weight: 36g

Length: 380mm

Wingspan: 290mm

Control Distance: 100m +/-

Flight Time Per Charge: 15' +/-

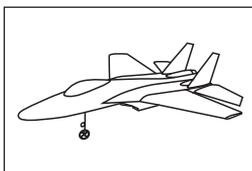

Airplane x 1 (RTF)

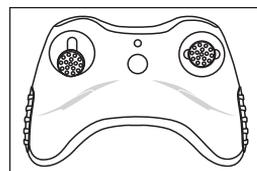

Controller x 1

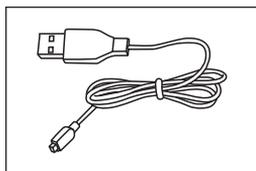

USB Charger x1

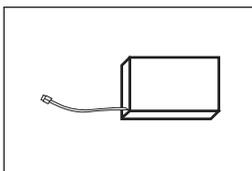

3.7V Li-Po Battery x1

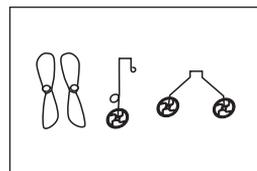

Accessory Kit x 1  
(Landing Gear Setx 1,  
Spear Propeller x 2)

**Attention: The flight performance may be affected by wind, adjust the airplane in the windless or breeze day.**

**Attention: This product is built with gyroscope that will adjust the flight balance automatically during flight. But if the airplane deformation exceeds the limit, the gyroscope may not be able to adjust the flight balance completely. In this case, you may need to adjust the airplane shape manually.**

**Attention: Once the propeller is broken, bent or deformed, replace the propeller immediately so as to avoid further damage to the airplane.**

# INSTALLATION:

## 1. To install the tail fins

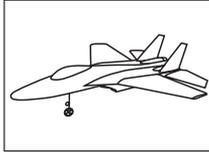
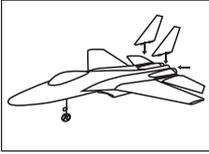

The vertical tail is properly fastened to the fuselage.

## 2. To install the landing gears

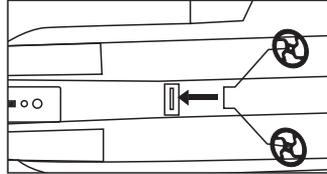
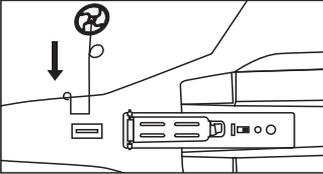

Install the landing gears as per illustrations.

## 3. To install the battery

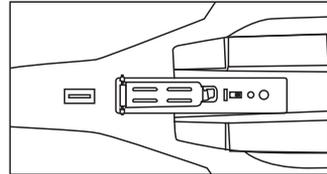
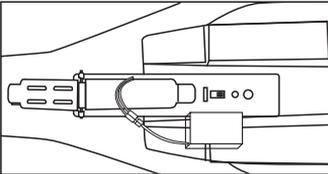

Install the battery to the airplane and close the battery compartment door as per illustrations.

# CONTROLLER

## Function of the keys

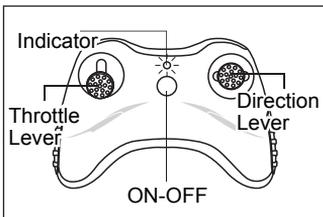

Low battery alarm: if the indicator keep flashing after signal synchronization, that shows the batteries of the controller is power weak, please replace the batteries before playing.

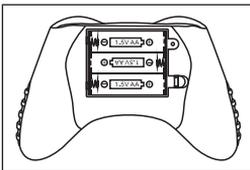

Attention:

Different type of batteries or new and used batteries are not to be mixed. Insert the batteries to the battery compartment with correct polarity.

Uses 3 "AA" batteries  
(not included)

## SIGNAL SYNCHRONIZATION FOR 2.4GHZ

- 1) Turn on the power of the airplane, the indicator on the airplane will keep flashing, it shows the airplane is pairing signal.
  - 2) Push the throttle lever to the lowest position and turn on the power of the controller, the indicator will keep flashing, it shows the controller is pairing signal.
  - 3) When both the indicators on the airplane and the controller stop flashing and keep light on, it shows the synchronization is successful.
- You are now able to control the airplane.

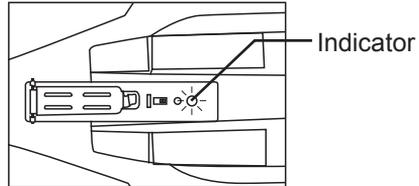
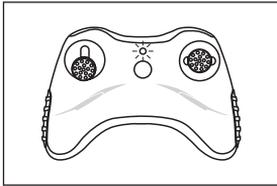

The indicator on the controller keeps flashing. It shows pairing signal.  
The indicator on the helicopter keep light on, it shows signal synchronization is successful.

## BATTERY RECHARGING

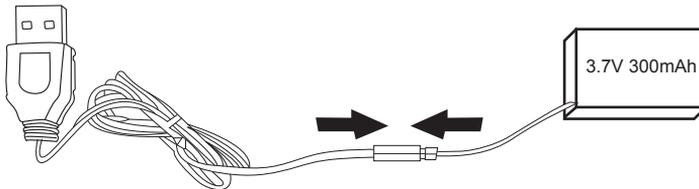

- 1) Connect the charging pin of the battery with the USB, and plug the USB to the USB hub of the power supply. The red indicator on the USB will light on, it shows the battery is being charged.
- 2) It takes about 40 minutes to charge. When the indicator on the USB lights off, it shows the charging is complete.
- 3) If the indicator on the USB keep flashing, it shows the USB or the battery is damaged, please replace them immediately.

## ATTENTION:

- \* Charging battery should be supervised by an adult.
- \* Charging must be kept away from flammable and explosive places.
- \* If the battery gets bulging, stop using it immediately.
- \* Take the battery out from the airplane after playing and keep it separately.

# ABOUT FLYING:

## 1) Environment for flying:



Not in windy weather



Not in rain or snow

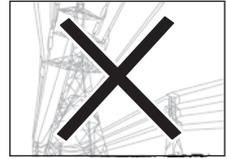

Not near the high-voltage lines



Not in crowd



Not around tall building



Be careful to fly around water area

**Please fly the airplane in the wide open areas, such as parks, outdoor fields and squares.**

## 2) Preparation

- A. Recharge the battery of the airplane fully. Install the battery to the airplane and close the battery compartment door properly.
- B. Make sure the batteries in the controller are full.
- C. Turn on both the airplane and the controller, synchronize the signal.
- D. Throttle up the controller to see if the propellers spin properly.
- E. Observe the airplane to make it is not deformed. (as figures)

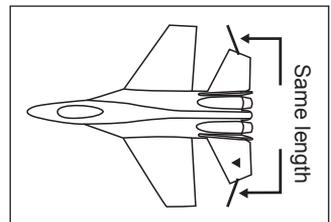
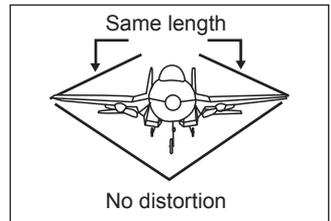

**Now your airplane is ready to fly.**

## 3) Operation

### A. Ground takeoff

Place the airplane on the flat ground, facing against the wind, throttle up gradually to the top, the airplane will slid forward and takeoff from the ground. When it is in the air with certain altitude, you can adjust the throttle lever to control the flight height and use the direction lever to control the flight direction.

## B. Hand-throw Takeoff

Hold the airplane at your hand and throttle up the lever, the propellers will spin fast, throw the airplane obliquely against the wind. After it flies in the air, use the throttle lever to control the flight height and the direction lever to control the flight direction.

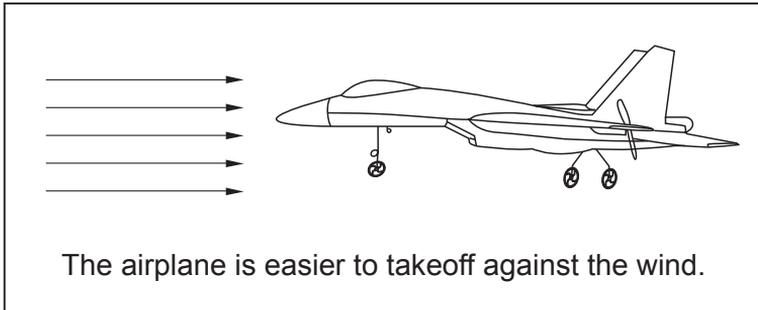

## C. Turning Skill

When you are controlling the flight direction, use the direction lever by point touch, do not push and hold the lever to one point, so as to avoid the airplane from dropping rapidly by large angle spiral or even causing crash. The airplane flies much faster downwind than against wind, when you are turning the airplane from downwind to against wind, it will have more resistance, you may need to prod the direction lever a few more times until it succeeds.

## D. Landing Skill

If you push the throttle lever to the top but the airplane does not climb up, it shows the battery of the airplane is power weak. You need to land the airplane as soon as possible. Turn the airplane against the wind, land the airplane softly by prodding the control levers.

# AIRPLANE ADJUSTMENT

## 1) The head is too heavy / light

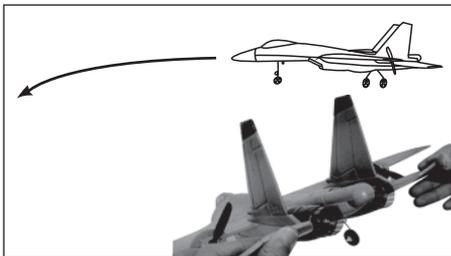

The head is too heavy during flight, fold the edge of the horizontal tail upwards.

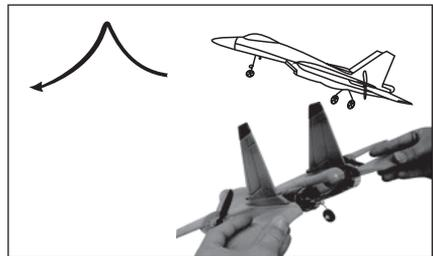

The head is too light during flight, fold the edge of the horizontal tail downwards.

## 2) The airplane does not fly straight

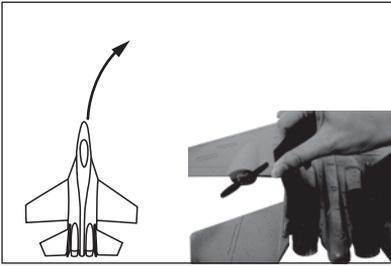

The airplane leans to the right during flight, fold the vertical tail to the left.

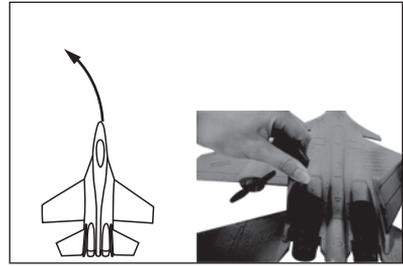

The airplane leans to the left during flight, fold the vertical tail to the right.

After the adjustment, fly the airplane again and adjust it again if needed until it can fly straight properly.

## REPLACING PROPELLERS

If the propellers get broken or bent during flight, please replace them with the spare propellers included in the package. Make sure to replace the propellers with correct types (As Figures).

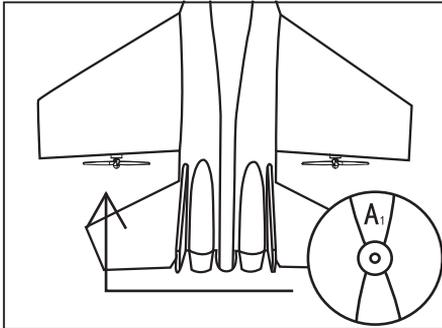

The propeller marking with A1 or A2 is to install on the left of the airplane.

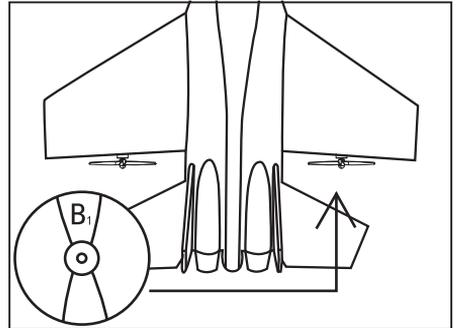

The propeller marking with B1 or B2 is to install on the right of the airplane.

# WARRANTY INFORMATION

Our product is guaranteed to be free from manufacturing defects for a period of 12 Months.

If your product becomes defective during this period, Electus Distribution will repair, replace, or refund where a product is faulty; or not fit for intended purpose.

This warranty will not cover modified product; misuse or abuse of the product contrary to user instructions or packaging label; change of mind and normal wear and tear.

Our goods come with guarantees that cannot be excluded under the Australian Consumer Law. You are entitled to a replacement or refund for a major failure and for compensation for any other reasonably foreseeable loss or damage. You are also entitled to have the goods repaired or replaced if the goods fail to be of acceptable quality and failure does not amount to a major failure.

To claim warranty, please contact the place of purchase. You will need to show receipt or other proof of purchase. Additional information may be required to process your claim.

Any expenses relating to the return of your product to the store will normally have to be paid by you.

The benefits to the customer given by this warranty are in addition to other rights and remedies of the Australian Consumer Law in relation to the goods or services to which this warranty relates.

This warranty is provided by:

Electus Distribution

Address 46 Eastern Creek Drive, Eastern Creek NSW 2766

Ph. 1300 738 555