

GH2047

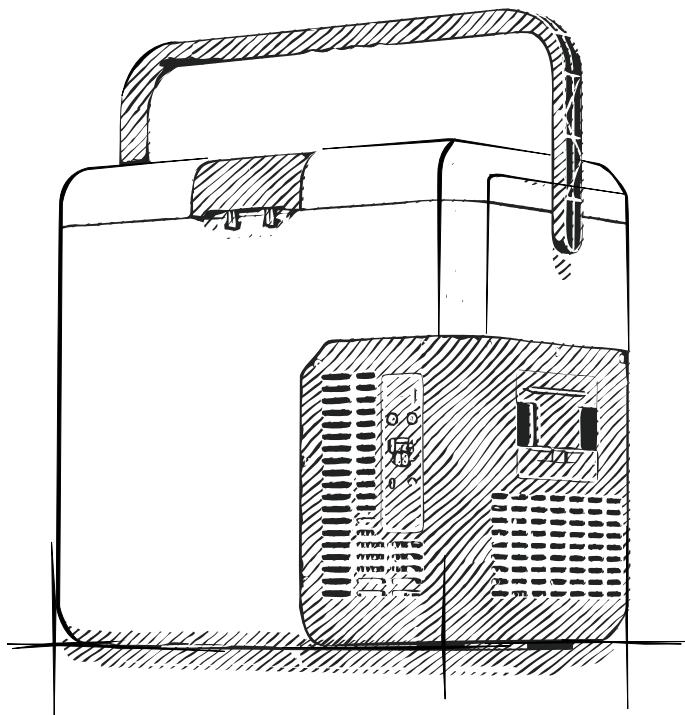

18L PORTABLE FRIDGE/FREEZER



INSTRUCTION MANUAL

CONTENTS

Warnings & Safety Information	3
Before First Use	4
Features	5
Box Contents	5
Product Diagram	5
Product Dimensions	6
Operation	6
Battery Usage	10
Food Storage	10
Troubleshooting	11
Specifications	12
Cleaning, Care, Storage & Maintenance	13
Smart Control - Fridge App Instructions	14
Warranty Information	16

WARNINGS & SAFETY INFORMATION

WARNING: The manufacturer is not responsible for any potential injury from misuse

Warnings

- Do not operate the appliance if it is visibly damaged.
- Do not block the gaps of the fridge with things like pins or wires, etc.
- Do not expose the appliance to rain or immerse it in water.
- Do not place the appliance near naked flames or other heat sources (heaters, direct sunlight, gas ovens etc.)
- Do not store any explosive substances like spray cans with a flammable propellant.
- Ensure the supply cord is dry and not trapped or damaged. Do not locate multiple portable socket-outlets or portable power supplies at the rear of the appliance.
- Check the voltage specification on the type plate corresponds to that of the energy supply. The appliance is only to be used with the power supply unit provided with the appliance.
- Do not use electrical appliances inside the food storage compartments of the appliance, unless they are of the type recommended by the manufacturer.
- Once unpacked and before turning on, the appliance must be placed on a level surface for more than 6 hours.
- Make sure that the appliance stays horizontally when it is running. The tilt angle must be less than 5° for long time running and be less than 45° for short time running.
- Keep the ventilation openings in the unit casing or in the built-in structure free of obstacles.
- Keep the appliance stable on the ground or in the car; Do not drain upside down.

Caution

- Repairs may only be carried out by qualified personnel. Incorrect repair may cause danger. The lamp and supply cord must be replaced by the manufacturer or qualified persons.
- The installation of DC power in a boat must be handled by qualified electricians.
- Children shall not play with the appliance. Cleaning and user maintenance shall not be made by children without supervision.
- The appliance can be used by children aged from 8 years and above and persons with reduced physical, sensory or mental capabilities or lack of experience and knowledge if they've been given supervision or instruction concerning use of the device in a safe way and understand the hazards.

Notice

- Disconnect the power supply before each cleaning and maintenance and after every use.
- Do not use sharp tools to defrost; Do not damage the refrigerant circuit.
- Risk of child entrapment. Before you throw away your old refrigerator or freezer: take off the doors: leave the shelves in place so that children may not easily climb inside.
- Check if the cooling capacity of the appliance is suitable for storing the food or medicine. Food may only be stored in its original packaging or in suitable containers.
- If the appliance is left empty for long periods, switch off, defrost, clean, dry, and leave the door open to prevent mould developing within the appliance.
- The appliance is intended to be used in household and similar applications such as:
 - Staff kitchen areas in shops, offices and other working environments;
 - Camping, Farm houses and by clients in hotels, motels and other residential environments;
 - Bed and breakfast type environments;
 - Catering and similar non-retail applications.
- Information, illustrations and specifications in this manual reflect the most current available at the time of publication, are subject to change without prior notice.
- Due to the flammable refrigerant and blowing gas contained in the device, comply with local regulations for disposal.

BEFORE FIRST USE

Prior to using your product, please read all the safety and operating instructions thoroughly. Please ensure you follow the steps below before using the product. We recommend you keep the original packaging for storing the product when not in use.

Please pay close attention to the section entitled Warnings & Safety Information. Find a safe and convenient place to keep this instruction manual for future reference.

Unpack the product but retain all packaging materials until you are satisfied that your new product is undamaged and in working order. Ensure you have all accessories listed in this manual.

FEATURES

- Suitable for storing 4 bottles of champagne upright
- Can be powered by an optional removable battery
- DC power connections
- High-efficiency DC compressor and conversion module
- Dual mode operation (Max & Economy)
- Digital temperature display with adjustable control
- 3 Year Warranty
- 3-stage low voltage battery protection
- USB port to charge USB devices
- APP control via Bluetooth

BOX CONTENTS

- 1 x 18L Portable Fridge/Freezer
- 1 x 12/24V Cigarette Lighter/Merit Car Charger

PRODUCT DIAGRAM

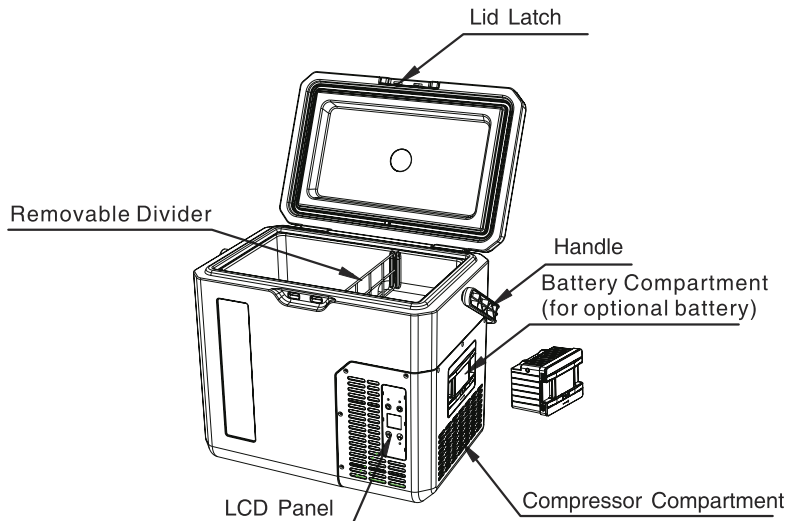

PRODUCT DIMENSIONS

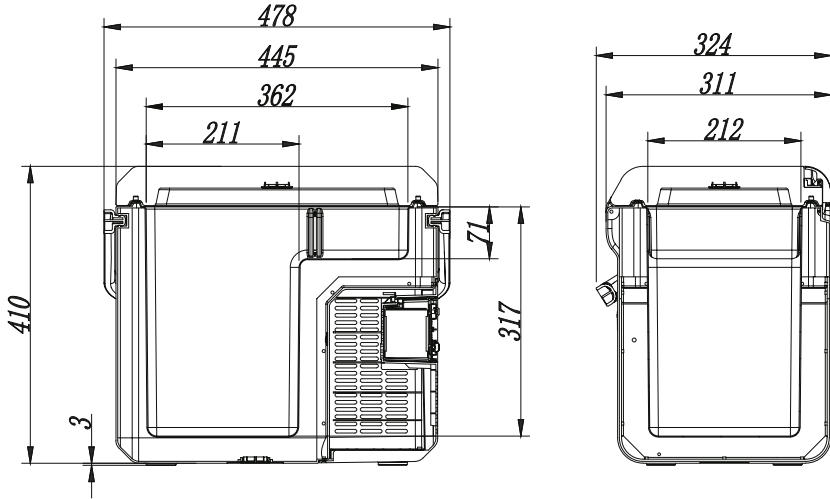

OPERATION

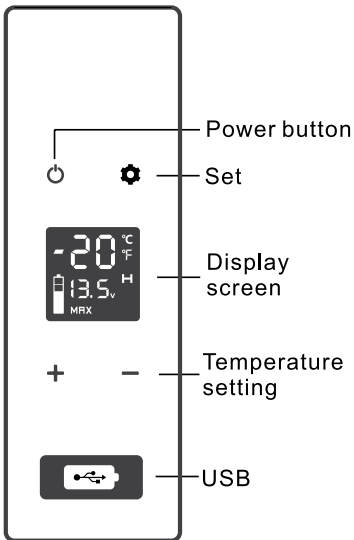

How to Turn on the Fridge

1. Connect to power
2. Press button 
3. The internal temperature will display and the compressor will start

SET: Press button  to enter different modes, ECO (Energy Saving Mode), and MAX (Fast Cooling Mode). Factory setting is MAX

Press button + or - and set the temperature to 20°C ~ -20°C

WARNING: Do not open or disassemble the battery.

Only use approved chargers with the fridge battery, incorrect chargers may result in fire, damage, a shortened battery life. Do not disassemble, impact, squeeze, crush, or throw or misuse the fridge battery, do not dispose of in fire, any of which may result in short circuit and fire or explosion. If there is swelling and heating of the fridge battery do not continue to use, it may result in fire or explosion, do not use the battery if it is wet or damp.

Battery Operation

Long press  on the battery to switch ON/OFF the battery

Tips to make the battery last longer:

1. Switch to ECO mode by pressing  on the fridge panel;
2. Set the battery protection to "L" mode (very important setting to make the battery work longer time)
3. Pre-chill the fridge to your ideal temperature in advance;
4. Do not open the door frequently;
5. Do not set the temperature too low if not necessary.

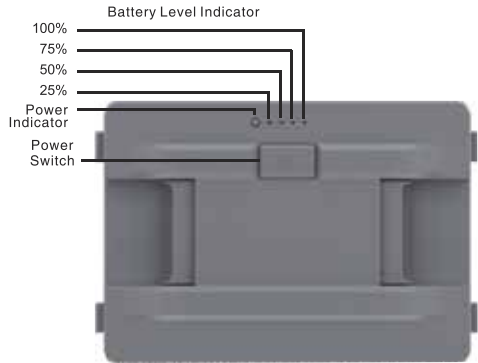

Battery Charging (for reference only)



Charge in the refrigerator
(in standby mode)

Wall outlet AC 100~240V (using dedicated adapter)

(For 15.6Ah battery, charging time~8hrs)

Car cigarette lighter DC 12/24V

(For 15.6Ah battery, if input voltage > 13.5V, charging time~8hrs)

Solar 12~50V

Connect to the "SOLAR" port of the refrigerator

(For 15.6Ah battery, when using 100W solar panel, charging time ~5hrs)



Charge separately

Battery charger (optional)

Connect to the DC charging port of the battery (For 15.6Ah battery, the charging time 8hrs)

NOTE: It is suggested to switch off the refrigerator when charging the battery as the power supply is designed to mainly power the compressor when the refrigerator is running.

NOTE: When connect to a solar panel, please place the refrigerator in a cool place to dissipate heat. The charging input power should be higher than the working power of the refrigerator (about 40-45W), or switch off the refrigerator, otherwise the battery will run out.

NOTE: It is suggested to use 100W optional solar panel. MAX Solar Input Voltage: 50V; MAX Solar Input Current:10A.

NOTE: When using a solar panel, the battery must be installed as the output of the solar panel is not suitable to power the refrigerator independently.

Checking Charge Status

When the refrigerator is powered ON and DC / AC power is connected, the battery icon on display screen will flash to show charging. To charge the fridge / freezer battery without running the compressor, simply connect the adapters without powering "ON" the fridge. To view charging status please press and hold button  for 3 seconds. The fridge's battery status and voltage will be displayed. When the battery icon stops flashing, the unit is fully charged.

WARNING: Do not charge fridge / freezer with DC 12V and Solar Panel at the same time! The fridge could be seriously damaged and pose a potential hazard to you.

AC Charging Management

If the fridge has not been used for a long time, the battery may be discharged, and the fridge will not power on. Please use the AC adapter to charge the fridge battery and run the fridge. After the fridge battery has charged up to 30%, you can switch to other methods for charging.

Car Cigarette Lighter Charging Management

The product has a three-level battery protection function, which not only guarantees the normal operation of the product, but also protect the battery of the vehicle. When in the power-on state, long press SET button for 3 seconds and the display screen flashes H, select low voltage production Low, Medium, and High by clicking button .

NOTE: The factory default is set to Low protection.

Voltage Reference

MODE \ INPUT	DC 12V		DC 24V	
	CUT OUT	CUT IN	CUT OUT	CUT IN
L	8.5V	10.9V	21.3V	22.7V
M	10.1V	11.4V	22.3V	23.7V
H	11.1V	12.4V	24.3V	25.7V

H should be set when the product is connected to car power, and M or L should be set when it is connected to a portable battery or other back-up battery. Because of the different output voltages between vehicles, the battery protection level can be set from H to M or from M to L if there is a voltage protection code F1 shown on the panel. The battery protection level should be set to H if the product will keep working after turning off the car engine, or the product may drain the battery.

NOTE: When using the optional battery, the fridge may enter F1 mode. In this case, you will need to set the protection mode to Low.

Solar Charging Management

To make sure your fridge is being charged by a solar panel, please turn the fridge on first. The battery icon will flash on the display screen to show the charging status. The fridge can be turned off while it is being charged. Press and hold  button for over 3 seconds to check the battery status and voltage. An extension cable may be required to keep the fridge in a cool place (to avoid overheating) while the solar panel is in the sun. Input power for charging should be higher than the refrigerator power draw (about 40-45w), otherwise the optional battery will not charge at the same time. To ensure that solar charging power is higher than refrigerator working power, a 100-Watt solar panel is advised.

BATTERY USAGE

Optional Removable Battery: The lithium battery is back up power to keep the refrigerator working for short periods while off grid.

Notice: When not using the battery power or fridge for a long time, please turn off the battery output. (Hold setting button for 3 Sec).

Maintain Battery Charge:

1. Home / Hotel: Use AC adapter to charge unit from AC outlet.
2. Car / Boat: Use DC port to power the fridge and charge the battery.
3. Off Grid: Put the optional battery inside the battery compartment of the fridge, and connect the optional solar panel to the fridge. Or use portable 12V power system / solar system.

WARNING: Do NOT connect the solar panel directly to the battery.

Extended battery usage:

1. Cool down the fridge before your journey: It is always suggested to charge fridge battery and cool the fridge down in advance with the mains to DC adapter from the wall outlet the day before the trip. To prepare for off-grid fridge usage, place food and beverages inside fridge for cooling the day before. This will not only keep the optional battery more durable, but also save energy for outdoor activities once on battery mode.
2. Disconnecting the Battery: The battery can be removed or disconnected with the side button. This prevents the battery from discharging. The product will work from the AC adapter or car outlet without the optional battery installed. Note: Please charge fully the optional battery before it is put into storage 1 month or more.

FOOD STORAGE

Freezer (-4° F~32° F)(-20°C~0°C):

Meat should be cut and packed properly when placed in the fridge.

Do not put the fresh food and frozen food together.

Do not store glass containers or other containers which seal in liquid in the freezer, to avoid explosion.

Refrigerator (32° F~50° F)(0°C~10°C):

Egg, butter, milk and bottle drinks can be stored.

All food should be packed appropriately before being stored in the fridge.

Place food in refrigerator after it gets cool in order to save energy.

TROUBLESHOOTING

ISSUE	SUGGESTED REMEDY
Refrigerator does not work	<ul style="list-style-type: none"> • Check if the switch is on. • Check if the plug and socket are connected well. • Check if the fuse has been burnt. • Check if the power supply is malfunctioned. • Switch on/off the fridge frequently may cause start delay of the compressor
Refrigerator compartments are too warm	<ul style="list-style-type: none"> • The lid is opened frequently. • A large amount of warm or hot food was stored recently. • The refrigerator has been disconnected for a long time.
Food is frozen	The temperature was set too low
There is "water flow" noise from inside the refrigerator	It's a normal phenomenon, caused by the flow of refrigerant.
There are waterdrops around the refrigerator casing or door gap	It's a normal phenomenon, the moisture will condense to water when it touches a cold surface of the refrigerator.
The compressor is slightly noisy when starting	It's a normal phenomenon, the noise will be reduced after the compressor works stably.
Code F1 displayed	Possible cause: low voltage to fridge. Adjust the battery protection from High to Medium or from Medium to Low.
Code F2 displayed	Possible cause: condenser fan is overloaded. Disconnect power to fridge for 5 minutes & re-start. If the code shows again, contact manufacturer for service.
Code F3 displayed	Possible cause: the compressor starts too frequently. Disconnect power to fridge for 5 minutes & re-start. If the code shows again, contact manufacturer for service.
Code F4 displayed	Possible cause: compressor not kicking in. Disconnect power to fridge for 5 minutes & re-start. If the code shows again, contact manufacturer for service
Code F5 displayed	Possible cause: overheating of the compressor & electronics. Disconnect power to fridge for 5 minutes & re-start. If the code shows again, contact manufacturer for service.
Code F6 displayed	Possible cause: no parameter can be detected by the controller. Disconnect power to fridge for 5 minutes & re-start. If the code shows again, contact manufacturer for service.
Code F7 or F8 displayed	Possible cause: temperature sensor is faulty. Contact manufacturer for service.

SPECIFICATIONS

Input Voltage	12 / 24V DC
Average Power Consumption	45W
Power Consumption	0.22kw.h / 24hr
Rated Current	4.0A (12V)/2.0(24V)
Temperature Range	-20°C to + 20°C (with ambient temperature at 25°C)
Refrigerant	R134a
Insulation	100% CFC & HFC free PU Foam insulation

CLEANING, CARE, STORAGE & MAINTENANCE

WARNING: Never use hard or sharp tools to remove ice or to loosen objects frozen in place.

Cleaning

- Unplug the device first to avoid electric shock.
- Use wet cloth to clean the device and dry it.
- Remove the cover and drain from the hole at the bottom of the device.
- Do not soak the device in water and do not wash it directly.
- Do not use abrasive cleaning agents as these can damage the device.

Storage



- If the device will not be in use for a long time, please follow the steps:
- Turn off the power and remove the plug.
- Remove all the items stored in the device.
- Remove the cover and drain from the hole, wipe off excess water with a soft rag.
- Leave the lid slightly open to prevent odour formation.
- Put the device in a cool and dry place.

Defrosting

- Humidity can form frost in the interior of the cooling device or on the evaporator, which will affect the cooling performance. Defrost the device regularly to avoid this.
- Switch off the device.
- Take out the contents of the device.
- Keep the lid open.
- Remove the cover and drain from the hole.
- Wipe off the defrosted water.

SMART CONTROL - FRIDGE APP INSTRUCTIONS

Downloading the "BRASS MONKEY" Application

- Using a pre-installed QR reader on your handheld smart device scan the QR code in the manual or on the carton, or search for the "BRASS MONKEY" APP in the iTunes™ App Store (for Apple™ devices) or Google store (Android Devices)
- Start the application and select the Searchfunction.
- The application will prompt you to pair the fridge by pressing the set button  on the fridge's control panel. Once set button  has been activated, the fridge will be paired with your smart device and the application will switch to a control panel allowing you to control the fridge's functions.

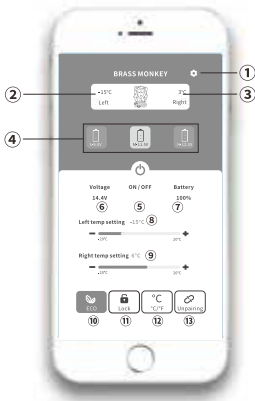

- ① SET
- ② Freezer zone current temperature
- ③ Refrigerator zone current temperature
- ④ Battery protection mode: High/Medium/Low
- ⑤ Turn ON/OFF the fridge
- ⑥ Current voltage
- ⑦ Battery capacity (Battery is not supported on this model)
- ⑧ Freezer zone temperature setting
- ⑨ Refrigerator zone temperature setting
- ⑩ ECO (Energy-saving) / MAX (Fast cooling) mode switch
- ⑪ Children's Lock/ Unlock
- ⑫ Celsius / Fahrenheit switch
- ⑬ Unpair the device and return to Search

Note:

* Click the lock icon  on the APP to lock/unlock the control panel on the fridge, if locked, the fridge can only be controlled by the APP.

Please scan the QR code to download APP

QR Code for Apple™ Devices



QR Code for Android Devices



WARRANTY INFORMATION

Our product is guaranteed to be free from manufacturing defects for a period of 3 years. If your product becomes defective during this period, Electus Distribution will repair, replace, or refund where a product is faulty; or not fit for intended purpose.

This warranty will not cover modified product; misuse or abuse of the product contrary to user instructions or packaging label; change of mind and normal wear and tear.

Our goods come with guarantees that cannot be excluded under the Australian Consumer Law. You are entitled to a replacement or refund for a major failure and for compensation for any other reasonably foreseeable loss or damage. You are also entitled to have the goods repaired or replaced if the goods fail to be of acceptable quality and failure does not amount to a major failure.

To claim warranty, please contact the place of purchase. You will need to show receipt or other proof of purchase. Additional information may be required to process your claim.

Any expenses relating to the return of your product to the store will normally have to be paid by you.

The benefits to the customer given by this warranty are in addition to other rights and remedies of the Australian Consumer Law in relation to the goods or services to which this warranty relates.