

15L
Fridge / Freezer
GH-2202
User Manual

FEATURES

- Can be powered by 2 optional removable batteries
- DC power connections
- High-efficiency DC compressor and conversion module
- Dual mode operation (Max & Economy)
- Digital temperature display with adjustable control
- 2 Year Warranty
- 3-stage low voltage battery protection
- USB port to charge USB devices
- APP control via Bluetooth

BOX CONTENTS

1 x Portable Fridge / Freezer
1 x 12 / 24V Car Cigarette Power Lead

SPECIFICATIONS

Input Voltage:	12 / 24V DC
Average Power Consumption:	45W
Power Consumption:	0.22kw.h / 24hr
Rated Current:	4.0A(12V)/2.0(24V)
Temperature Range:	-20°C to + 20°C (with ambient temperature at 25°C)
Refrigerant:	R134a
Insulation:	100% CFC & HFC free PU Foam insulation

SAFETY

- The installation of DC power sources in a boat must be handled by a qualified electrician
- Make sure to connect power to the suitable voltage socket
- No electrical devices are to be used inside the product
- The product can be powered on only after being unpacked and put on a flat level surface for over 6 hours
- Fridge operating angle: The fridge can be operated indefinitely at up to 5 degrees, and can be operated at between 6 and 45 degrees for up to 30 mins.
- Product must be well ventilated. Ensure there is a minimum of 200mm clearance at the back, and 100mm around the sides
- The product should be in a well-ventilated space, away from heat sources. Try to avoid direct exposure to sunlight
- Keep product stable
- When there is water inside the fridge, do not turn the product upside down to empty. Dry the water with a soft cloth.
- Do not put metal in the air inlet vent, outlet vent, or gap
- Do not connect to other power except 12V / 24V DC, or the 240V AC to 12V DC adapter (sold separately)
- Do not soak the product in water or wash with water
- The product should not be repaired. If there is any issues please consult the place of purchase
- Turn off the product before cleaning to avoid electric shocks or other issues
- Keep product away from wet or humid places

PRODUCT STRUCTURE

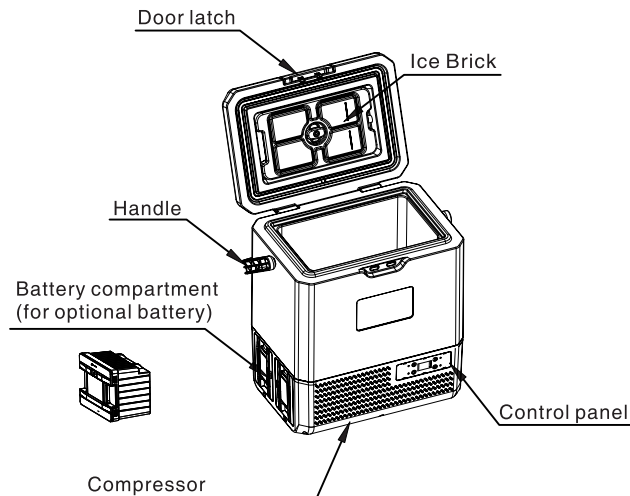

*Note: the ice brick can be removed by rotating the knob. Add water to the ice brick, do not exceed 400ml. The ice brick is used to improve insulation, do NOT drink the water inside the ice brick, do not let children play with it.

DIMENSIONS

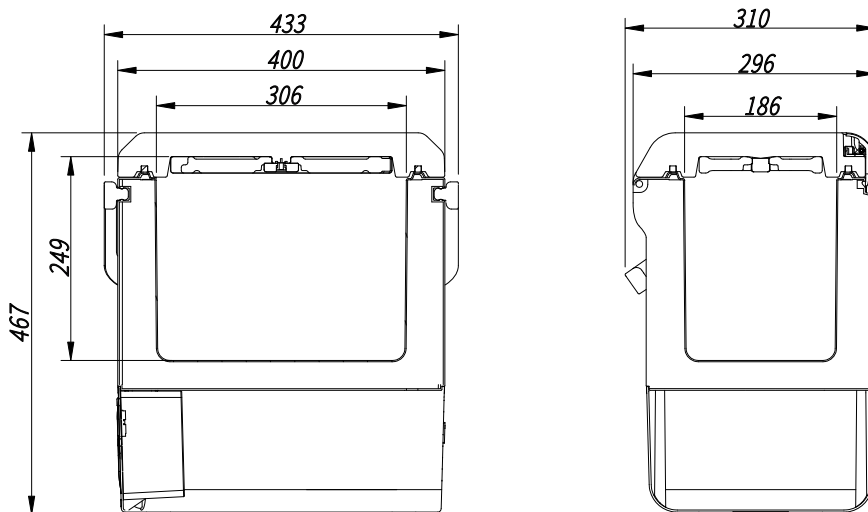

GH-2202

OPERATION

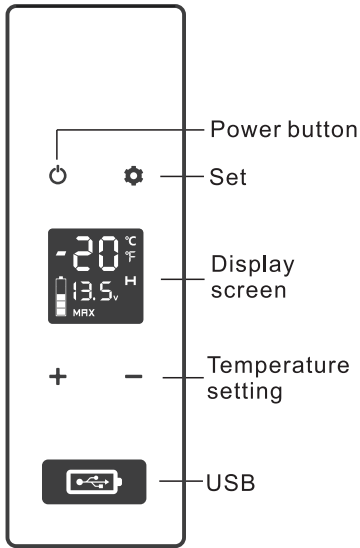

- **How to Turn on the Fridge**

1. Connect to power

2. Press button

3. The internal temperature will display and the compressor will start

- **SET:** Press button to enter different modes, ECO (Energy Saving Mode), and MAX (Fast Cooling Mode). Factory setting is MAX

- Press button + or - and set the temperature to 20°C ~ -20°C

Recommended temperature for common food:

Drinks	Fruits	Vegetable	Delicatessen	Wine	Ice cream	Meat
5°C/41°F	5~8°C/41~46°F	3~10°C/37~50°F	4°C/39°F	10°C/50°F	-10°C/14°F	-18°C/0°F

POWER SUPPLY AND CHARGING

- Power Supply: The refrigerator can be powered by 12V / 24V DC power
 - Optional removable Lithium battery if there is no connection of DC / AC power. DC / AC power will run the refrigerator, and charge the optional removable battery simultaneously.
 - 100-240VAC to 12VDC adapter (optional)
 - Battery Charging: connect the fridge to DC/AC, and place the battery into the fridge battery case, the battery will be charged automatically. But the power supply will mainly power the compressor when the refrigerator is running, which will cause the battery to charge slowly. If you want to charge the battery quickly, please turn off the refrigerator. Or you can take out the battery from the fridge case and charge it by the optional battery charger from wall power.
- Notice: the battery must be removed from the appliance before it scrapped;
The fridge must be disconnected from the supply mains when removing the battery; the battery needs to be disposed safely.



Optional Removable Battery



With optional 100-240VAC to 12VDC adapter



Car cigarette lighter with DC cable



DC cable
(included)



Battery Charger for wall power
(Optional)

Optional Removable Battery Information:

Battery Model	Capacity	Rated Voltage	Charging Limited Voltage	Max Charging Current
GH-2206	15.6AH	11.1V	12.6V	4A

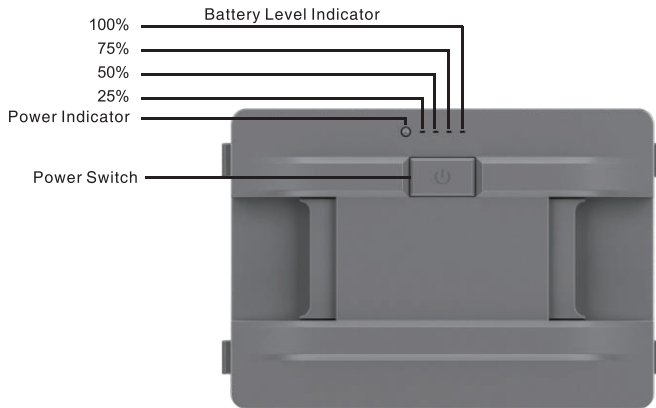

 **Warning:** please do not open or disassemble the battery.

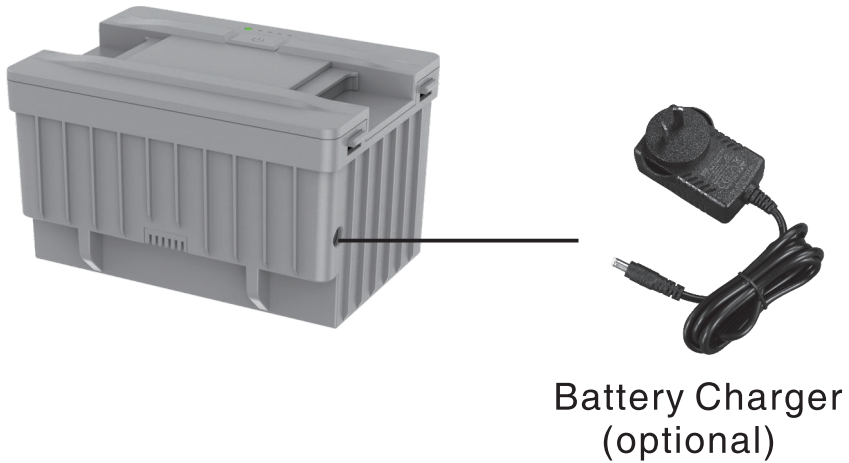

- **Checking Charge Status:** When the refrigerator is powered ON and DC / AC power is connected, the battery icon on display screen will flash to show charging. To charge the fridge / freezer battery without running the compressor, simply connect the adapters without powering "ON" the fridge. To view charging status please press and hold button  for 3 seconds. The fridge's battery status and voltage will be displayed. When the voltage reaches 12.6V and the battery icon stops flashing, the unit has been fully charged and wiring should be disconnected to prevent internal component from damage.

 **Warning:** Do not charge fridge / freezer with DC 12V and Solar Panel at the same time! The fridge could be seriously damaged and pose a potential hazard to you.

- **AC Charging Management**

If the fridge has not been used for a long time, the battery may be discharged, and the fridge will not power on. Please use the AC adapter to charge the fridge battery and run the fridge. After the fridge battery has charged up to 30%, you can switch to other methods for charging.

- **Car Cigarette Lighter Charging Management**

The product has a three-level battery protection function, which not only guarantees the normal operation of the product, but also protect the battery of the vehicle. When in the power-on state, long press SET button for 3 seconds and the display screen flashes H, select low voltage production L(ow), M(edium), and H(igh) by clicking button . The factory default is set to H(igh) protection.



H should be set when the product is connected to car power, and M or L should be set when it is connected to a portable battery or other back-up battery. Because of the different output voltages between vehicles, the battery protection level can be set from H to M or from M to L if there is a voltage protection code F1 shown on the panel. The battery protection level should be set to H if the product will keep working after turning off the car engine, or the product may drain the battery.

BATTERY USAGE

- **Optional Removable Battery:** The lithium battery is back up power to keep the refrigerator working for short periods while off grid.
- **Notice:** When not using the battery power or fridge for a long time, please turn off the battery output. (Hold setting button for 3 Sec).
- **Maintain Battery Charge:**
 1. Home / Hotel: Use AC adapter to charge unit from AC outlet.
 2. Car / Boat: Use DC port to power the fridge and charge the battery.

- **Extended battery usage:**

1. **Cool down the fridge before your journey:** It is always suggested to charge fridge battery and cool the fridge down in advance with the mains to DC adapter from the wall outlet the day before the trip.

To prepare for off-grid fridge usage, place food and beverages inside fridge for cooling the day before. This will not only keep the optional battery more durable, but also save energy for outdoor activities once on battery mode.

2. **Disconnecting the Battery:** The battery can be removed or disconnected with the side button. This prevents the battery from discharging. The product will work from the AC adapter or car outlet without the optional battery installed. **Note:** Please charge fully the optional battery before it is put into storage 1 month or more.

FOOD STORAGE

- **Freezer (-4° F~32° F)(-20°C~0°C):**



1. Meat should be cut and packed properly when placed in the fridge.
2. Do not put the fresh food and frozen food together.
3. Do not store glass containers or other containers which seal in liquid in the freezer, to avoid explosion.

- **Refrigerator (32° F~50° F)(0°C~10°C):**

1. Egg, butter, milk and bottle drinks can be stored.
2. All food should be packed appropriately before being stored in the fridge.
3. Place food in refrigerator after it gets cool in order to save energy.

SMART CONTROL FRIDGE APP APPLICATION INSTRUCTION

Search for the "ROVIN FRIDGE" application in the iTunes App store (for Apple devices) or Google store (Android Devices).

- Connect the fridge to power and switch it on using the control panel.
- Start the application and select the "Search" function.
- The application will prompt you to pair the fridge by pressing the set button  on the fridge's control panel, Once set button  has been activated, the fridge will be paired with your smart device and the application will switch to a control panel allowing you to control the fridge's functions.

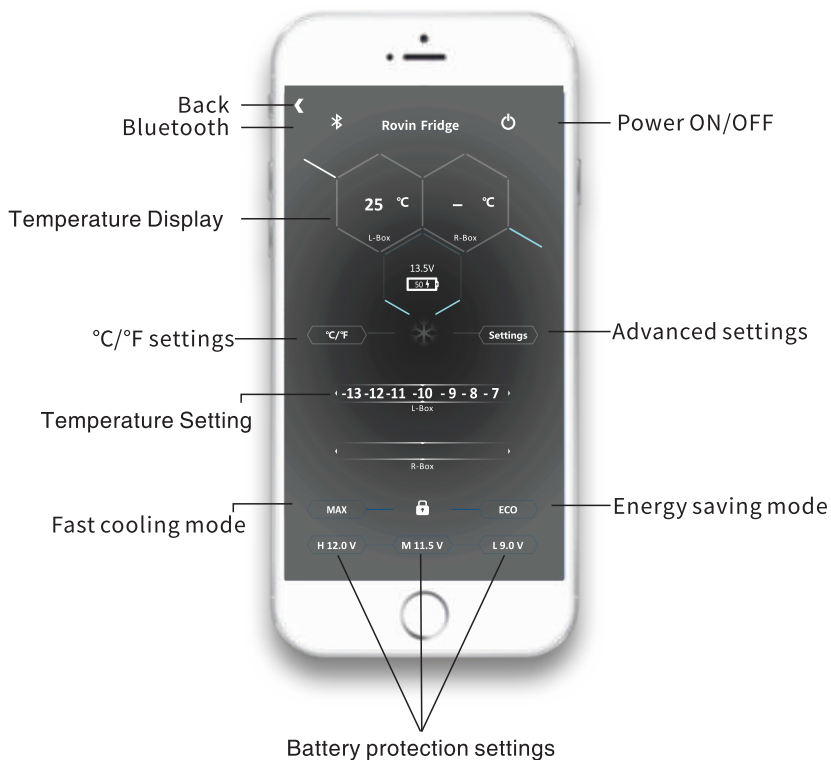

Please scan the QR code to download APP

QR Code for Apple Devices



QR Code for Android Devices



CLEANING & MAINTENANCE

Cleaning:

- Unplug the device first to avoid electric shock.
- Use wet cloth to clean the device and dry it.
- Do not soak the device in water and do not wash it directly.
- Do not use abrasive cleaning agents as these can damage the device.

Storage:

If the device will not be in use for a long time, please follow the steps:

- Turn off the power and remove the plug.
- Remove all the items stored in the device.
- Wipe off excess water from the fridge with a soft rag.
- Put the device in a cool and dry place.
- Leave the door slightly open to prevent odors from forming.

Defrosting:

Humidity can form frost in the interior of the cooling device or on the evaporator.

This reduces the cooling capacity. Defrost the device in good time to avoid this.

- Switch off the device.
- Take out the contents of the device.
- Keep the door open.
- Wipe off the defrosted water.



Never use hard or sharp tools to remove ice or to loosen objects which have frozen in place.

TROUBLESHOOTING

- The product is not working:
 - If using the 240VAC to 12VDC adapter (sold separately) check the power supply is working
 - If using the DC cable please ensure the cable still works.
 - Check the power supply is working
 - Check if the plug and socket are connected
 - Check the fuse
 - Check power switch on control panel is on
 - Compressor starts delay protection for 3 minutes after turning on
- Food inside the product is frozen:
 - Temperature is set too low
- Water flowing sound inside the tank:
 - Refrigerant is flowing, this is normal
- Water drops around the case or door gap:
 - When moisture in the air meets the lower temperature case, it will naturally become liquefied and condensed. Wipe away with a towel or soft cloth
- Code F1 displayed:
 - Low voltage protection, which can be solved by setting the battery protection button from H to M or from M to L
- Code F2 displayed:
 - Fan overload protection. Please turn off the product and restart it after 30 minutes. If the code displays again, please contact the place of purchase
- Code F3 displayed:
 - Compressor frequent start protection. Please turn off the product and restart it after 30 minutes. If the code displays again, please contact the place of purchase
- Code F4 displayed:
 - Compressor is overloaded or working at a low speed. Please turn off the product and restart it after 30 minutes. If the code displays again, please contact the place of purchase

- Code F5 displayed:
 - High temperature compressor module protection. Please move the product to a ventilated area and turn it off for 30 minutes then restart it. If the code displays again, please contact the place of purchase
- Code F6 displayed:
 - No parameter can be detected by the controller. Please restart the product. If the code displays again, please contact the place of purchase
- Code F7 / F8 displayed:
 - Temperature sensor error protection. Please check the sensor terminal

The warranty for this product is 2 years from date of purchase. During the warranty period the following are excluded from coverage:

- Intentional damage
- Damage by fire, flood, etc
- Damage or malfunction caused by incorrect usage and not following this user manual
- Damage or malfunction caused by disassembling

Distributed by:

TechBrands by Electus Distribution Pty. Ltd.

320 Victoria Rd, Rydalmere, NSW 2116, Australia

Ph: 1300 738 555

Int'l: +61 2 8832 3200

Fax: 1300 738 500

www.techbrands.com

Made in China