

GH1676

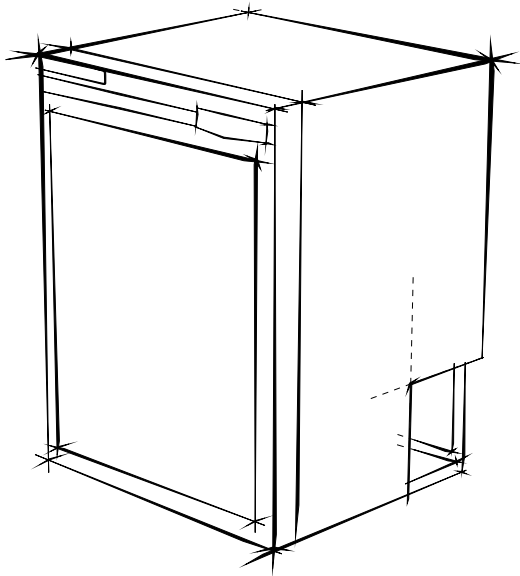

**65L
CARAVAN
FRIDGE**



INSTRUCTION MANUAL

CONTENTS

| | |
|---|----|
| Warnings & Safety Information | 3 |
| Before First Use | 4 |
| Features | 5 |
| Box Contents | 5 |
| Product Diagram | 5 |
| Operation | 6 |
| Installation..... | 7 |
| Door Hinge Direction | 8 |
| Troubleshooting | 9 |
| Cleaning, Care, Storage & Maintenance..... | 10 |
| Smart Control - Fridge App Instructions | 11 |
| Specifications | 12 |
| Warranty Information..... | 12 |

WARNINGS & SAFETY INFORMATION

WARNING: The manufacturer is not responsible for any potential injury from misuse

Warnings

- Do not operate the appliance if it is visibly damaged.
- Do not block the gaps of the fridge with things like pins or wires, etc.
- Do not expose the appliance to rain or immerse it in water.
- Do not place the appliance near naked flames or other heat sources (heaters, direct sunlight, gas ovens etc.)
- Do not store any explosive substances like spray cans with a flammable propellant.
- Ensure the supply cord is dry and not trapped or damaged. Do not locate multiple portable socket-outlets or portable power supplies at the rear of the appliance.
- Check the voltage specification on the type plate corresponds to that of the energy supply. The appliance is only to be used with the power supply unit provided with the appliance.
- Do not use electrical appliances inside the food storage compartments of the appliance, unless they are of the type recommended by the manufacturer.
- Once unpacked and before turning on, the appliance must be placed on a level surface for more than 6 hours.
- Make sure that the appliance stays horizontally when it is running. The tilt angle must be less than 5° for long time running and be less than 45° for short time running.
- Keep the ventilation openings in the unit casing or in the built-in structure free of obstacles.
- Keep the appliance stable on the ground or in the car; Do not drain upside down.

Caution

- Repairs may only be carried out by qualified personnel. Incorrect repair may cause danger. The lamp and supply cord must be replaced by the manufacturer or qualified persons.
- The installation of DC power in a boat must be handled by qualified electricians.
- Children shall not play with the appliance. Cleaning and user maintenance shall not be made by children without supervision.
- The appliance can be used by children aged from 8 years and above and persons with reduced physical, sensory or mental capabilities or lack of experience and knowledge if they've been given supervision or instruction concerning use of the device in a safe way and understand the hazards.

Notice

- Disconnect the power supply before each cleaning and maintenance and after every use.
- Do not use sharp tools to defrost; Do not damage the refrigerant circuit.
- Risk of child entrapment. Before you throw away your old refrigerator or freezer: take off the doors: leave the shelves in place so that children may not easily climb inside.
- Check if the cooling capacity of the appliance is suitable for storing the food or medicine. Food may only be stored in its original packaging or in suitable containers.
- If the appliance is left empty for long periods, switch off, defrost, clean, dry, and leave the door open to prevent mould developing within the appliance.
- The appliance is intended to be used in household and similar applications such as:
 - Staff kitchen areas in shops, offices and other working environments;
 - Camping, Farm houses and by clients in hotels, motels and other residential environments;
 - Bed and breakfast type environments;
 - Catering and similar non-retail applications.
- Information, illustrations and specifications in this manual reflect the most current available at the time of publication, are subject to change without prior notice.
- Due to the flammable refrigerant and blowing gas contained in the device, comply with local regulations for disposal.

BEFORE FIRST USE

Prior to using your product, please read all the safety and operating instructions thoroughly. Please ensure you follow the steps below before using the product. We recommend you keep the original packaging for storing the product when not in use.

Please pay close attention to the section entitled Warnings & Safety Information. Find a safe and convenient place to keep this instruction manual for future reference.

Unpack the product but retain all packaging materials until you are satisfied that your new product is undamaged and in working order. Ensure you have all accessories listed in this manual.

FEATURES

- High efficiency DC compressor and module which is robust and durable.
- Fast cooling to 0° C (based on 25° C ambient temperature).
- Intelligent voltage detect system to protect car battery.
- CFC free and low energy consumption.
- Designed to be powered by 12V/24V DC.
- LCD display for temperature setting.
- Bluetooth APP for temperature monitor and control.

BOX CONTENTS

1 x 65L Caravan Fridge

PRODUCT DIAGRAM

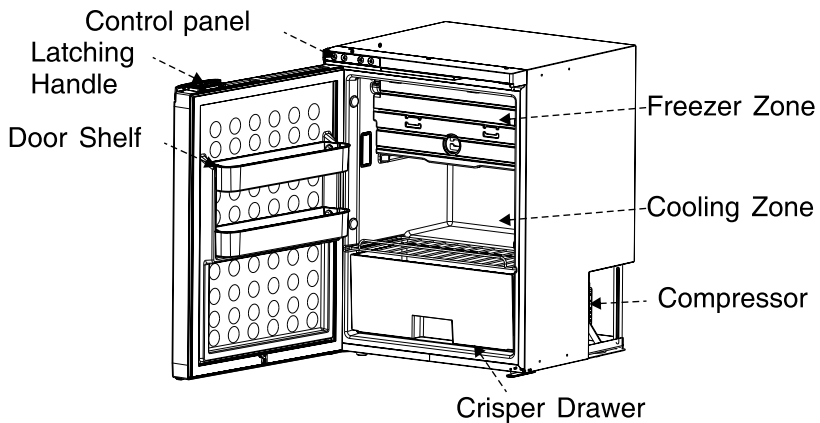

OPERATION

How to Turn on the Fridge

- Connect to 12/24V power
- press the power button
- The internal temperature will display

Temperature Setting

- Press , to display 'FR'(freezer zone temperature setting) or 'RE' (refrigerator zone temperature setting).
- Select either the fridge zone or the freezer zone temperature. You cannot select separate temperatures for each zone at the same time; you must choose which zone you want to more accurately control the temperature of. The zone not selected to control the temperature of will be then cooled as a slave zone relative to the temperature set by the other zone.
- Press "+" or "-" to adjust the temperature of the respective zone.



To Reset

- Power off the fridge
- Holding the setting button  until E1 is displayed.
- Press button "+" and "-" at the same time until the display is as below.



Battery Protection Mode Setting

The product has a three-level battery protection function, which not only guarantees the normal operation of the product, but also protect the battery of the vehicle.

When powered on, long press settings button  for 3 seconds and the display screen flashes H, select low voltage production L(ow), M(edium), and H(igh) by clicking settings button . The factory default is set to L(ow) protection.

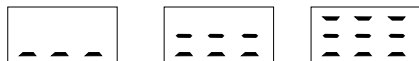

From left to right: L/M/H.

H should be selected when the fridge is connected to the vehicle starter battery, and M or L should be selected when powering from a deep cycle battery. If error code F1 is shown on the panel it means that the fridge is in voltage protection mode, meaning the fridge will operate again once the battery is charged or the battery protection model is lowered from H to M, or M to L.

INSTALLATION

Ensure that the refrigerator is in good order and not damaged when opening the packaging for the first time.

Any transportation damage must be reported promptly to the place of purchase within 24 hours of taking delivery.

Handle the product with the utmost care and attention.

1. When installing in a cavity/cabinet.

The refrigerator dimensions are 470*430*630mm (A*C*B), there should be enough space (75mm minimal) at the rear and top of the refrigerator to ensure adequate ventilation. There should be a minimum of 7.5mm of space on each side.

Cabinet dimensions suggested 485*505*705mm (A1*C1*B1).

Always place the refrigerator on a flat and level surface that is adequate to support its weight. Place the refrigerator in a location away from heat sources and ensure that it has enough ventilation.

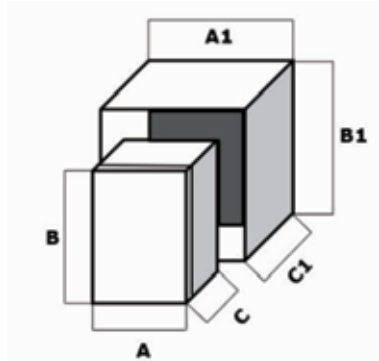

2. Connect to a power supply

Connect the refrigerator to the vehicle 12/24VDC system directly, the minimal cable cross-section as per the below table based on the overall length of wire between the refrigerator and the battery. Enough excess wire needs to be kept to allow for moving the fridge into and out of the cabinet.

| Wire Length to Refrigerator | Wire Gauge |
|-----------------------------|------------|
| Maximum 6 m | 14AWG |
| Maximum 11m | 12AWG |
| Maximum 17m | 10AWG |

It is highly recommended that the installation fridge is carried out by a qualified person.

3. Push the refrigerator into cabinet

Push the refrigerator into the cabinet carefully to avoid scratching the floor, and that the power cable is kept loose, is not kinked or damaged.

4. Mount the fridge with the cabinet wall

Mounting points (holes) are built into the side wall of the refrigerator, a hole needs to be drilled into the cabinet to line up with the mounting points on the side of the fridge.

Fix the fridge with screws (M5, 15mm minimum to the cabinet walls, then use the screw covers included to hide the screws. A total 4 screws are required (not included) for installation into a cabinet.

5. Verify the installation

Once the installation had been finished, check the continuity of the negative circuit and carry out all electrical safety testing provided for by current regulations. Protect and fix the cables in order to prevent accidental pulling of the cable and from it disconnecting from any connections or the power source and ensure it doesn't come into contact with heat sources with a temperature of 50°C or more, or with sharp objects.

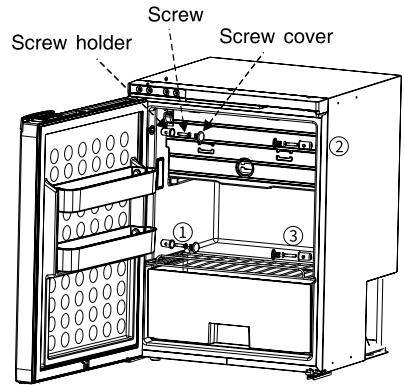

DOOR HINGE DIRECTION

1. Unscrew the bottom hinge (9)
2. Take off the door body (keep the fridge stable)
3. Unscrew and take off the door latch (8), install it into the new location of door latch (6)
4. Remove the door head decorative sheet (5), install it into new location of the door head decorative sheet (7).
5. Move the top door axle (1) and bottom door axle (3) to new position (2)(4)
6. Install the door to the refrigerator, fasten the top door axle with the top hinge; install the bottom hinge screws (4), fix the door with the hinge;
7. Close the door, the door opening direction is now reversed.

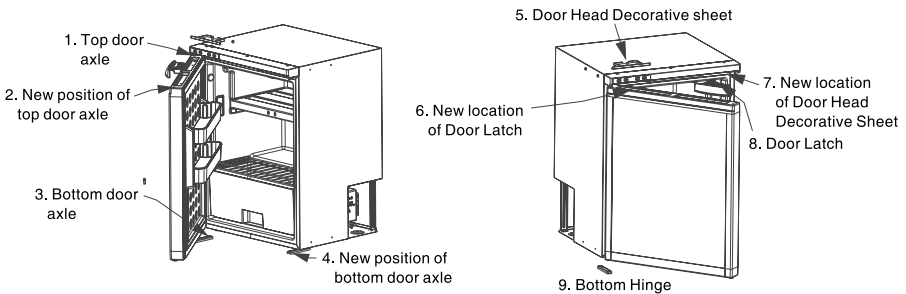

TROUBLESHOOTING

| ISSUE | SUGGESTED REMEDY |
|---|---|
| Refrigerator does not work | <ul style="list-style-type: none"> • Check if the switch is on. • Check if the plug and socket are connected well. • Check if the fuse has been burnt. • Check if the power supply is malfunctioned. • Switch on/off the fridge frequently may cause start delay of the compressor |
| Refrigerator compartments are too warm | <ul style="list-style-type: none"> • The lid is opened frequently. • A large amount of warm or hot food was stored recently. • The refrigerator has been disconnected for a long time. |
| Food is frozen | The temperature was set too low |
| There is "water flow" noise from inside the refrigerator | It's a normal phenomenon, caused by the flow of refrigerant. |
| There are waterdrops around the refrigerator casing or door gap | It's a normal phenomenon, the moisture will condense to water when it touches a cold surface of the refrigerator. |
| The compressor is slightly noisy when starting | It's a normal phenomenon, the noise will be reduced after the compressor works stably. |
| Code F1 displayed | Possible cause: low voltage to fridge. Adjust the battery protection from High to Medium or from Medium to Low. |
| Code F2 displayed | Possible cause: condenser fan is overloaded. Disconnect power to fridge for 5 minutes & re-start. If the code shows again, contact manufacturer for service. |
| Code F3 displayed | Possible cause: the compressor starts too frequently. Disconnect power to fridge for 5 minutes & re-start. If the code shows again, contact manufacturer for service. |
| Code F4 displayed | Possible cause: compressor not kicking in. Disconnect power to fridge for 5 minutes & re-start. If the code shows again, contact manufacturer for service |
| Code F5 displayed | Possible cause: overheating of the compressor & electronics. Disconnect power to fridge for 5 minutes & re-start. If the code shows again, contact manufacturer for service. |
| Code F6 displayed | Possible cause: no parameter can be detected by the controller. Disconnect power to fridge for 5 minutes & re-start. If the code shows again, contact manufacturer for service. |
| Code F7 or FS displayed | Possible cause: temperature sensor is faulty. Contact manufacturer for service. |

CLEANING, CARE, STORAGE & MAINTENANCE

WARNING: Never use hard or sharp tools to remove ice or to loosen objects frozen in place.

Cleaning

- Unplug the device first to avoid electric shock.
- Use wet cloth to clean the device and dry it.
- Remove the cover and drain from the hole at the bottom of the device.
- Do not soak the device in water and do not wash it directly.
- Do not use abrasive cleaning agents as these can damage the device.

Storage



- If the device will not be in use for a long time, please follow the steps:
- Turn off the power and remove the plug.
- Remove all the items stored in the device.
- Remove the cover and drain from the hole, wipe off excess water with a soft rag.
- Leave the lid slightly open to prevent odour formation.
- Put the device in a cool and dry place.

Defrosting

- Humidity can form frost in the interior of the cooling device or on the evaporator, which will affect the cooling performance. Defrost the device regularly to avoid this.
- Switch off the device.
- Take out the contents of the device.
- Keep the lid open.
- Remove the cover and drain from the hole.
- Wipe off the defrosted water.

SMART CONTROL - FRIDGE APP INSTRUCTIONS

Downloading the "BRASS MONKEY" Application

- Using a pre-installed QR reader on your handheld smart device scan the QR code in the manual or on the carton, or search for the "BRASS MONKEY" APP in the iTunes™ App Store (for Apple™ devices) or Google store (Android Devices)
- Start the application and select the Searchfunction.
- The application will prompt you to pair the fridge by pressing the set button  on the fridge's control panel. Once set button  has been activated, the fridge will be paired with your smart device and the application will switch to a control panel allowing you to control the fridge's functions.

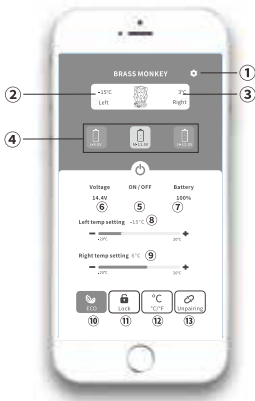

- ① SET
- ② Freezer zone current temperature
- ③ Refrigerator zone current temperature
- ④ Battery protection model: High/Medium/Low
- ⑤ Turn ON/OFF the fridge
- ⑥ Current voltage
- ⑦ Battery capacity (Battery is not supported on this model)
- ⑧ Freezer zone temperature setting
- ⑨ Refrigerator zone temperature setting
- ⑩ ECO(Energy-saving) / MAX(Fast cooling) mode switch
- ⑪ Children's Lock/ Unlock
- ⑫ Celsius / Fahrenheit switch
- ⑬ Unpair the device and return to Search

Note:

* Click the lock icon  on the APP to lock/unlock the control panel on the fridge, if locked, the fridge can only be controlled by the APP.

Please scan the QR code to download APP

QR Code for Apple™ Devices



QR Code for Android Devices



SPECIFICATIONS

| | |
|--------------------------|--------------------------|
| Rated Voltage | DC 12/24V |
| Power Consumption | 60W |
| Capacity | 65L |
| Noise Emission | ≤45dB |
| Temperature Range | 0-8°C(RE)/ -12~-20°C(FR) |
| Climate Class | T/ST/N/SB |
| Dimensions(W*H*D) | 430*630*470 mm |
| N.W. | 19.06KG |
| G.W. | 21.21KG |

WARRANTY INFORMATION

Our product is guaranteed to be free from manufacturing defects for a period of 3 years. If your product becomes defective during this period, Electus Distribution will repair, replace, or refund where a product is faulty; or not fit for intended purpose.

This warranty will not cover modified product; misuse or abuse of the product contrary to user instructions or packaging label; change of mind and normal wear and tear.

Our goods come with guarantees that cannot be excluded under the Australian Consumer Law. You are entitled to a replacement or refund for a major failure and for compensation for any other reasonably foreseeable loss or damage. You are also entitled to have the goods repaired or replaced if the goods fail to be of acceptable quality and failure does not amount to a major failure.

To claim warranty, please contact the place of purchase. You will need to show receipt or other proof of purchase. Additional information may be required to process your claim.

Any expenses relating to the return of your product to the store will normally have to be paid by you.

The benefits to the customer given by this warranty are in addition to other rights and remedies of the Australian Consumer Law in relation to the goods or services to which this warranty relates.

Electus Distribution
Address 46 Eastern Creek Drive, Eastern Creek NSW 2766
Ph. 1300 738 555