



DIGITECH

DC-1068

DC-1069



Professional FM Transceiver Instruction Manual

Use of the citizen band radio service is licensed in Australia by ACMA Radiocommunications (Citizen Band Radio Stations) Class Licence and in New Zealand by MED General User Radio Licence for Citizens Band Radio. Operation is subject to conditions contained in those licences.

Controls and Indicators

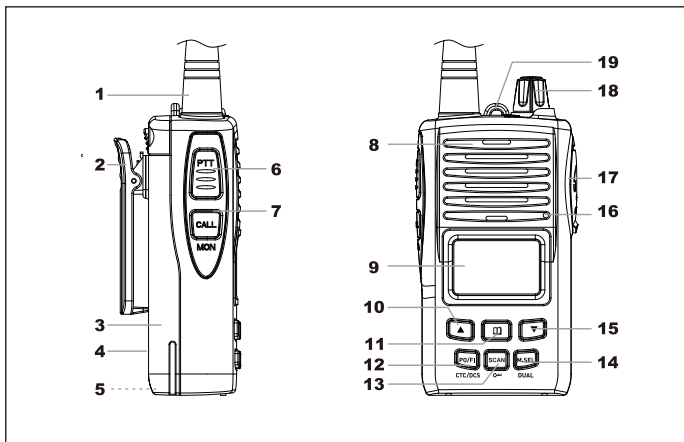

1. Antenna
2. Belt Clip
3. Battery compartment with Battery
4. Charger connector
5. Battery compartment cover latch
6. Push to Talk **PTT** button
7. Call / Monitor button
8. Speaker Grill
9. LCD Display
10. Up ▲ button (CHANNEL/ MENU)
11. Menu button
12. Police, Fire / CTCSS, DCS key
13. Scan, Group scan/ key lock button
14. Memory select / Dual Watch
15. Down ▼ button (CHANNEL/ MENU)
16. Microphone
17. Ear-mic / Charge Jack
18. On-off switch/ volume control
19. Lanyard holder

LCD Display

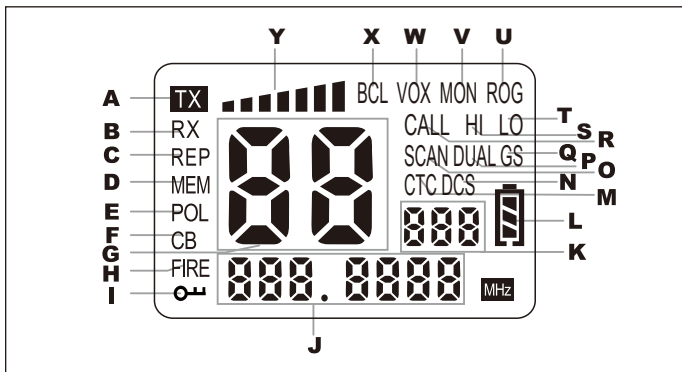

- A. TX Icon- is lighted when the radio is in Transmit mode.
- B. RX Icon- is lighted when the radio is in Receive mode.
- C. REP Icon- is lighted when the repeater function is ON.
- D. MEM Icon- memory indicator.
- E. POL Icon- Police band indicator.
- F. CB Icon- Citizen band indicator.
- G. Selected channel indicator.
- H. FIRE Icon- Fire station band indicator.
- I. Keypad key Lock Icon.
- J. Channel Frequency indicator.
- K. CTCSS/DCS sub-code number.
- L. Battery status indicator.
- M. CTCSS Icon
- N. DCS Icon.
- O. Scan Icon- Channel/memory channel scanning.
- P. Dual Icon-Dual watch function.
- Q. GS Icon-Group scanning function.
- R. Call Icon-Call tone transmit.
- S. HI Icon- 5 Watts transmission
- T. LO Icon- 1 Watts transmission
- U. ROG Icon- Roger tone indicator.
- V. MON Icon- Monitoring weak signal.
- W. VOX Icon- Voice activate transmission.
- X. BACL Icon- Busy Channel indicator.
- Y. TX/RX Level indicator.

Feature

- FM transmission
Frequency:476.425 - 477.4125MHz
1~80 channels
- 1W/5W output power selection
- TOT timer
- Police channel
- Fire channel
- 100 programeable receiver channel
- 38 CTCSS and 104 DCS
- External headset (earphone, microphone and ext PTT)
- VOX function (off, 1,2,3,4,5)
- Call tone melody (10 songs)
- Rotary switch volume with power on/off
- LCD back-light function (3 colors)
- Key back-light
- 5 steps adjustable and automatic squelch function
- 20 memory store
- Repeater function
- Key lock function
- Key tone function (selectable on/off)
- Roger tone function (selectable on/off)
- 4 level battery indicator
- Tx and Rx icon
- Dual watch function
- Scan channel/Memory scan/ Group Scan
- IP67 water proof
- 1200mAh Li-ion battery pack
- Charging indication (icon flashing)
- Cigarette car charger plug (optional)

Installation

1. Removing the Belt Clip
 - a. Pull the Belt Clip Latch away from the unit.
 - b. While pulling the Belt Clip Latch, push up the Belt Clip as shown in Figure 1.

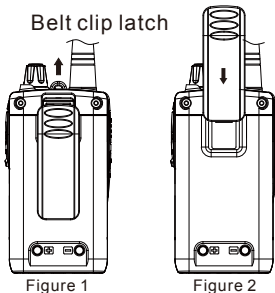

2. Installing the Belt Clip
 - a. Slide the Belt Clip into the slot as shown in Figure 2.
 - b. A “click” indicates the Belt Clip is locked into position.

3. Installing the supplied Li-ion Rechargeable Battery (Battery built-in to the battery cover).

- a. Install the supplied Li-ion rechargeable battery as shown in Figure 4.
- b. Lock the Battery into position as shown in Figure 5.

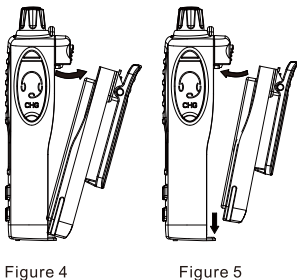

4. Charging the Rechargeable Battery pack.

Recommend to turning OFF the unit while charging.
Charge the Battery pack 10-14 hrs. prior to initial use.

5. Screw the supplied antenna into the antenna socket firmly.

To Charge the unit using Charger pod

1. Place the unit into the charger pod (Figure 5);
2. Insert the socket plug on the end of the AC-DC adaptor or Car Charger to the socket at the back of the charger pod (Figure 6);
3. The LED indicator on the charger pod will turn to RED once electricity get connected.
4. The LED indicator on the charger pod will turn to Green once charge fully.

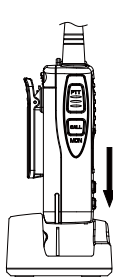

Figure 5

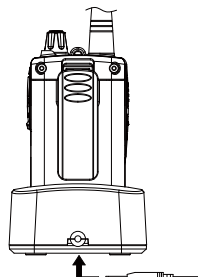



Figure 6

NOTE: The unit can be charged while ON or OFF mode.

Or Charge the unit directly

1. Insert the socket plug of the Car Charger into the charger jack (CHG) located on the right of the unit. (Figure 7);
2. The unit indicate the  icon without blinking when the battery is fully charged.

NOTE: The unit can be charged while OFF mode.

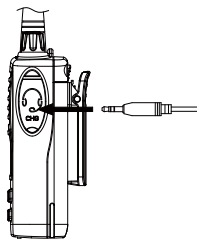

Figure 7

To Charge the battery pack using Charger pod

1. Insert the socket plug on the end of the AC-DC adaptor or Car Charger to the socket at the back of the charger pod (Figure 9);
2. The LED indicator on the charger pod will turn to RED once electricity get connected.
3. The LED indicator on the charger pod will turn to Green once charge fully.

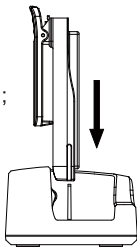

Figure 8

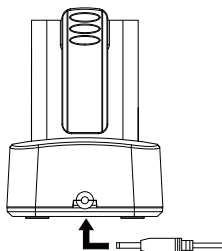

Figure 9

Battery Pack Warning

1. This equipment contains a Li-ion Battery Pack.
2. Do not mix with different battery types.
3. Do not dispose of the battery in fire.
4. Do not short-circuit the Battery Pack.



The exclamation point within an equilateral triangle is intended to alert the user to the presence of important operating and maintenance (servicing) instructions in the literature accompanying the appliance.

Operation

Turning on the radio

Rotate the ON/OFF volume knob clockwise to turn ON and adjust the volume, then going to self-inspection.

A series of tones will indicate the radio is on and full screen displayed 1 second.

If it is the first time to turn on the radio, the default parameter as below:

Parameter	Default setting
Channels	CB 001
CTCSS privacy codes	00
DCS privacy codes	00
SQ Level	03
DUPLE	OFF
TX power	Hi(5W)
VOX Level	OFF
MEM Channel	/
GS	OFF
Call Tone	1
BUSY	OFF
Roger Tone	OFF
BEEP	OFF
Backlight	ORANGE
Lock states	UNLOCK

Turning off the radio

Rotate the ON/OFF volume knob counterclockwise to turn OFF radio.

Channel Selection

Press the ▲ or ▼ button one time to select the desired channel (1-80).

Press and hold the ▲ or ▼ button, the selection will move quicker.

- Before selecting a channel for transmitting, always listen on it and ensure it is not already being used. Always avoid selecting a busy channel when the unit keeps on receiving signal from unknown party. The icon 'RX' will be displayed.

Repeater function

The repeater function is a third party facility that is only available in some



local areas. When the repeater function is on, the REP icon will be displayed. Only use this function for extending your communication range when you know the channel of the repeater facility in your area.

Unless it is necessary, avoid operation on locally used repeater input channels (channels 1-8 and 41-48) or locally used repeater receiving channels (channels 31-38 and 71-78).

If you transmit on Ch01 Duplex mode, you are actually transmitting on Ch31 the repeater station down-converts your signal and retransmits on Ch01.

Operating the UHF CB Radio in Duplex Mode

Press  button once, the duplex icon flashes;

Press  or  to change the setting between ON or OFF (standard channel numbering).

REP icon appears when a selected channel is set to Duplex Mode.



NOTE

- Only channels 01-08 and channels 41-48 are available for Duplex. Check with your local Retailer for information on available repeaters.

Sending a Call Tone

With the unit in normal mode, press the **CALL/MON** button. The microphone will be muted and the unit will transmit the current Call tone to other users with the same channel and CTCSS code.

The **TX** icon will be displayed on the LCD display.

Call tone can only be transmitted once (not more than 3 sec) in any 60 sec period.

It means that the unit will not transmit a call tone more than once no matter how many times you press the **CALL/MON** button within a minute.

Selecting a channel

Before selecting a channel for transmitting, always listen on it and ensure it is not already being used.

Always avoid selecting a busy channel when the unit keeps on receiving signal from unknown party. the RX icon will be displayed.

The factory default start up channel is channel 01 and sub-channel 00.

Press **▲** or **▼** to select the desired channel.

Channel Banks

The unit has three banks (groups) of channels to select from:

CB UHF CB + user programmable RX channels¹

POL Pre-programmed Police frequencies²

FIRE Pre-programmed Fire & Ambulance frequencies²

When the CB icon is showing the 80 UHF CB and any selection or scanning. The 80 UHF CB channels are numbered 01-80.

The user programmable RX channels are numbered 81-180 and only show, in the CTCSS/DCS code area, when programmed.

When the POL icon is showing then pre-programmed icon is showing then pre-programmed fire & ambulance frequencies do not have channel numbers, instead PO appears in the channel display for a police frequency and FI appears for a fire or ambulance frequency.

Press PO/FI to select the desired channel banks combination.

The channel banks can be selected as follows:

---- CB ----
POL ---- ----
---- ---- FIRE
POL ---- FIRE
POL CB ----
---- CB FIRE
POL CB FIRE



NOTE

¹ Available frequencies & channels are within 400-520MHz band only in 12.5kHz steps.

²Police, Fire & Ambulance reception is unencrypted analogue. For Australia, Channels 05 and 35 are reserved for Emergency calls.

CTCSS (Continuous Tone Coded Squelch System)

The unit has 38 CTCSS private codes available.

Different CTCSS tones may be associated to different channels. To choose the desired CTCSS code:

Press and hold CTC/DCS button until the CTCSS code number blinks;

Press ▲ or ▼ button to select the desired CTCSS code number;

Press and hold ▲ or ▼ button to move faster through the selection;

Press **CTC/DCS** once to store the new setting.

DCS (Digital Coded Squelch)

The unit has 104 DCS private codes available.

Different DCS tones may be associated to different channels.

DCS codes follow after the 38 CTCSS codes.

Follow the steps for setting a CTCSS code, Press ▲ or ▼ button until the DCS codes flashes.

Press **CTC/DCS** to store the new setting.



NOTE

Selecting a CTCSS/DCS code will disable the CTCSS/DCS feature. To communicate between two or more units, both the channel and CTCSS/DCS code selections must be the same; To communicate with other models and brands of units, the actual frequency and CTCSS/DCS frequency must be matched; CTCSS/DCS codes on emergency channels 5 and 35 are prohibited.

HI/LOW power setting

This feature permits the selection of the transmitting power level to high or low. Before transmitting a speech to other units, press the **[M]** button two times to select the desired power output 1W(LO) or 5W(HI).

VOX Sensitivity Level setting

In VOX mode, the unit will transmit a signal only when it is activated by your voice or other sounds around you. The unit will transmit for a further for 1 second even if you stop talking.

To set the VOX sensitivity level:

1. Press **[M]** button three times, the **vox** icon will display and the current VOX level will start blinking on the LCD display.
2. Press the **[▲]** or **[▼]** button to select the VOX level sensitivity or OFF.

The highest sensitiving level is 5.

SQ Level setting

1. Press the **[M]** button four times.
2. Press the **[▲]** or **[▼]** button to select the desired level 1-5. Level 1 has better sensitie will noise.
3. Press PTT to return.

Memory setting

1. Press **[M]** button five times, until the **MEM** icon is displayed and channel number is blinking.
2. Press **[▲]** or **[▼]** button to select desired channel, then press **PTT** button to confirm the channel.
The most channel you can store 20 channels.

Memory Select function

1. Press the **[M.SEL]** button enter the Memory Select mode.
2. Press the **[▲]** or **[▼]** button to select the program memory channel.
3. Press the **[M.SEL]** button to return.



- while the **[M.SEL]** icon is lighted, you can select the programmed memory channels only.
- Press the **[M.SEL]** button for return, you can select all channels as desire.

Scanning

Channel scan performs searches for active signals in an endless loop of channels.

Scan only checks channels or frequencies that are in the SCAN Memory, which are indicated by the MEM icon. The unit has two Scan Memory modes:

Open Scan(OS) mode and Group Scan (GS) mode, to give you flexibility and allow you to use the unit more effectively. Furthermore, any combination of the three channel groups can be scanned by pressing CTC/DCS during scan to select the desired channel groups.

Press scan to start scanning. The SCAN icon appears.

The scan direction can be changed at any time by pressing ▲ or ▼.

Press SCAN to stop scanning.

Add/Remove channels from scan Memory

Select which scanning mode you wish to use OS or GS.

Select the channel you want to store.

Press and Hold MEM to store. MEM icon appears.

To remove the channel from SCAN memory, press and hold MEM once more.

The MEM icon disappears.

Group Scan(GS) Mode

GS Mode has no channels in the SCAN Memory by default.

Channels must be added to the GS SCAN Memory before group scan can start. To add/remove channels from GS SCAN Memory.

To select GS Scan Mode:

1. Press  button six times, the GS setting flashes.
2. Press ▲ or ▼ to change the setting between ON and OFF.

Call Tone setting



Press  button seven times, the call icon flashes.

Press ▲ or ▼ to change the setting between 1 to 10.

Busy Channel Lockout

If the channel is already in use, you can prevent the UHF CB Radio from transmitting. This is particularly important when using CTCSS/DCS.

Press  button eight times, the BCL icon flashes.

Press  or  to change the setting between ON and OFF.

Roger Beep

Press  button nine times, the roger beep icon flashes.

Press  or  to change the setting between ON and OFF.



Key Beep

Press  button ten times, the key beep setting flashes.

Press  or  to change the setting between ON and OFF.

Backlight colour

Press  button eleven times, the backlight colour setting flashes.

Press  or  to select colour (3 colours:orange/red/green)

100 User programmable RX Channels

The unit has 100 receive only channels (Ch81 to Ch180) which can be programmed with frequencies ranging from 400-520MHz (in 12.5kHz steps). The extra RX channels only appear, as part of the CB channel bank, when a frequency has been programmed to a channel. There are two ways to programme RX channels:

If you know the frequency you may manually programme it to a channel.

Store a Police or Fire (& Ambulance) frequency to a channel.

Manually Programme a RX Channel

In CB channel (UHF CB channel):

Press and hold  button, the lowest available empty RX channel will flash.



Press  or  if you wish to select another RX channel.

Press SQ to begin the frequency edit. The MHz digit range flashes. Use MENU to shift between MHz range (between 400-520MHz) & kHz range (in 12.5Hz steps).

Press  or  to select the desired frequency within MHz & kHz ranges.

When finished press CALL/MON. the channel flashes to enable selection for programming of next channel if desired.

Store a Police or Fire frequency to a RX channel



Select the Police or Fire (& Ambulance) channels group by pressing CTCSS/DCS, and then select a desired frequency using  or .

Or during SCAN, when scan stops on a Police or Fire (& Ambulance) frequency which you wish to store press MENU to stay on that frequency.

Press and hold MENU, the lowest available empty RX channel will appear, alternating with the selected Police and Fire (& Ambulance) frequency.

Change the RX channel using  or  if desired.

Key Lock

Press and hold the  button for 2 seconds to activate/deactivate the Key Lock feature, the  icon will appear/disappear on the LCD display.

Battery Level Indicator

While the battery at low voltage, the  icon is blinking for every 1 second on LCD display.

The unit can indicate the  icon and containing is blinking in turn while charging.

The unit indicate the  icon without blinking when the battery is fully charged.

Channel Table

Channel Number	Frequency (MHZ)	Channel Number	Frequency (MHZ)	Channel Number	Frequency (MHZ)
1*	476.4250	28	477.1000	55	476.7875
2*	476.4500	29	477.1250	56	476.8125
3*	476.4750	30	477.1500	57	476.8375
4*	476.5000	31*	477.1750	58	476.8625
5*	476.5250	32*	477.2000	59	476.8875
6*	476.5500	33*	477.2250	60	476.9125
7*	476.5750	34*	477.2500	61++	–
8*	476.6000	35*	477.2750	62++	–
9	476.6250	36*	477.3000	63++	–
10	476.6500	37*	477.3250	64	477.0125
11	476.6750	38*	477.3500	65	477.0375
12	476.7000	39	477.3750	66	477.0625
13	476.7250	40	477.4000	67	477.0875
14	476.7500	41*	476.4375	68	477.1125
15	476.7750	42*	476.4625	69	477.1375
16	476.8000	43*	476.4875	70	477.1625
17	476.8250	44*	476.5125	71*	477.1875
18	476.8500	45*	476.5375	72*	477.2125
19	476.8750	46*	476.5625	73*	477.2375
20	476.9000	47*	476.5875	74*	477.2625
21	476.9250	48*	476.6125	75*	477.2875
22+	476.9500	49	476.6375	76*	477.3125
23+	476.9750	50	476.6625	77*	477.3375
24	477.0000	51	476.6875	78*	477.3625
25	477.0250	52	476.7125	79	477.3875
26	477.0500	53	476.7375	80	477.4125
27	477.0750	54	476.7625		

* Channel 5 and 35 are for emergency calling. Please do not use these sub-channels in non-emergency cases.

+ Speech telephony is inhibited on Channel 22 and 23.

* Channel 1-8 and 31-38, 41-48 and 71-78 are used as repeater channels with 750kHz offset. Channels 1-8 and 41-48 are used for mobile reception and channels 31-38 and 71-78 for mobile transmission.

Only use this repeater function when a long distance communication via the local repeater facility is specifically required. Unless it is necessary, to avoid operation on locally used repeater input channels (channels 31 to 38 and channels 71 to 78) or locally used repeater receiving channels (channels 1 to 8 and channels 41 to 48) is recommended.

++ Channel 61, 62 and 63 are reserved for future use. They cannot be activated until approved by the ACMA CBRS Class Licence in Australia.

CTCSS Frequency Table

Sub Channel	Frequency (HZ)	Sub Channel	Frequency (HZ)	Sub Channel	Frequency (HZ)
1	67.0	14	107.2	27	167.9
2	71.9	15	110.9	28	173.8
3	74.4	16	114.8	29	179.9
4	77.0	17	118.8	30	186.2
5	79.7	18	123.0	31	192.8
6	82.5	19	127.3	32	203.5
7	85.4	20	131.8	33	210.7
8	88.5	21	136.5	34	218.1
9	91.5	22	141.3	35	225.7
10	94.8	23	146.2	36	233.6
11	97.4	24	151.4	37	241.8
12	100.0	25	156.7	38	250.3
13	103.5	26	162.2		

DCS Frequency Table

Channel Number	Octal Code	Channel Number	Octal Code	Channel Number	Octal Code
1	023	36	223	71	445
2	025	37	225	72	446
3	026	38	226	73	452
4	031	39	243	74	454
5	032	40	244	75	455
6	036	41	245	76	462
7	043	42	246	77	464
8	047	43	251	78	465
9	051	44	252	79	466
10	053	45	255	80	503
11	054	46	261	81	506
12	065	47	263	82	516
13	071	48	265	83	523
14	072	49	266	84	526
15	073	50	271	85	532
16	074	51	274	86	546
17	114	52	306	87	565
18	115	53	311	88	606
19	116	54	315	89	612
20	122	55	325	90	624
21	125	56	331	91	627
22	131	57	332	92	631
23	132	58	343	93	632
24	134	59	346	94	654
25	143	60	351	95	662
26	145	61	356	96	664
27	152	62	364	97	703
28	155	63	365	98	712
29	156	64	371	99	723
30	162	65	411	100	731
31	165	66	412	101	732
32	172	67	413	102	734
33	174	68	423	103	743
34	205	69	431	104	754
35	212	70	432		

Specifications

General

Frequency Control	PLL
Frequency Tolerance	2.5PPM (at 25°C)
Transmit	2.5PPM (at 25°C)
Receive	0°C to +55°C
Operation Temperature	Flexible whip
Antenna	Built-in Electret type
Microphone	Liquid Crystal Display
Display	8Ω, 1 Watt
Speaker	Rechargeable Li-ion
Power Source	Battery pack 7.4V 1200mAh

Transmitter

Frequency Range	476.425 - 477.4125MHz
Frequency Stability	±3 PPM
Power Output	1W & 5W
Spurious Emissions	1 μW
Current Drain	800mA (1W), 1650mA (5W)

Receiver

Receiver Type	Double Conversion Super Heterodyne Phase Locked Loop system for Local Oscillator
Frequency Range	400.000-520.000MHz
Sensitivity (12dB SINAD)	-3 dBμV (emf)
Audio Output Power	0.5W @ 10% THD
Current Drain	Squelched 40mA
Max. Audio	350mA

Troubleshooting

- **Not enough range**
Cause: Line of sight blocked
Increase antenna height.
- **Will not transmit on 5 Watt range but will transmit on the 1 Watt range.**
Cause: Low voltage
Recharge or replace the batteries.
- **Will not transmit while charging**
Cause: Low voltage
The radio is not designed to transmit while charging.
DC or AC adaptor does not supply enough power for transmitting.
- **Battery will not charge**
Cause: Low voltage
Do not to transmit while charging.
The adaptor does not supply enough power for transmitting.

