



# INSTRUCTION MANUAL

## TX3510S

Compact fully featured 5 watt UHF CB radio



## TX3520S

Compact fully featured remote mount 5 watt UHF CB radio



## TX3540S

Compact fully featured remote mic 5 watt UHF CB radio



ScanSuite™



Full Spectrum  
Backlighting



Pure Sound



Advanced Signal  
Management



Dynamic Volume  
Control



Voice Inversion  
Scrambler



Front and Rear  
Mic Input



ScanSuite™   
faster, smarter scanning

## CONTENTS

SUPPLIED WITH.....	3	Scanning.....	13
INTRODUCTION.....	3	Open Scan.....	14
IMPORTANT INFORMATION CONCERNING UHF CB RADIO.....	3	Group Scan.....	15
Possible Issues.....	4	Network Scan.....	16
Emergency Channels.....	4	CTCSS and DCS.....	18
Telemetry Channels.....	4	Selective Calling.....	20
FEATURES.....	4	Using SelCall.....	20
GENERAL OPERATIONS.....	6	Responding to SelCall Alert.....	22
TX3510S/TX3520S Front Panel Controls.....	6	Quiet Mode.....	22
LCD Panel.....	6	Group Calling.....	24
Rear Panel.....	6	Receive-only Channels.....	25
TX3540S Controller Microphone.....	7	Configuration Menu.....	29
TX3510S/TX3520S Microphone.....	7	INSTALLATION.....	30
TX3540S Controller LCD Panel.....	7	General.....	30
GENERAL OPERATION ACROSS ALL MODELS.....	8	TX3510S and TX3540S Installation.....	30
Keypad Functions.....	8	TX3520S Installation.....	31
Volume.....	9	Microphone.....	31
Selecting Channels.....	9	DC Power Connection.....	32
Squelch.....	9	ANTENNA CONNECTION.....	33
Signal Meter.....	9	NOISE SUPPRESSION.....	33
Transmitting.....	9	Wiring.....	34
Time-Out Timer.....	10	CTCSS TONE FREQUENCY CHART.....	35
Backlighting.....	10	DCS TONE CHART.....	36
Bandwidth Filter Settings.....	11	UHF CB OPERATING FREQUENCIES.....	37
Dynamic Volume Control.....	11	SPECIFICATIONS.....	38
Voice Scrambler.....	11	SC CONTRACT WARRANTY AGAINST DEFECTS.....	39
Beep Tone Volume.....	12		
Silent Squelch Tail.....	12		
Repeaters and Duplex Mode.....	12		
Priority Channel.....	13		

## SUPPLIED WITH

<b>TX3510S</b>	<b>TX3520S</b>	<b>TX3540S</b>
TX3510S Radio	TX3520S Radio	TX3540S Radio
Mounting Cradle	TX3520S Remote Head	Mounting Cradle
Microphone	Mounting Cradle	Controller Microphone
Microphone Clip	Microphone	Microphone Extension Lead
DC Lead	Microphone Clip	8 Pin to 8 Pin Adapter
Screw Pack	DC Lead	Microphone Clip
Instruction Manual	Connecting Cable	DC Lead
	Screw Pack	Screw Pack
	Instruction Manual	Instruction Manual

## INTRODUCTION

Your GME TX3510S/TX3520S/TX3540S 80 channel radio is Australian designed and built and is the most advanced UHF Citizen Band radio available. It combines the very latest in electronic hardware with the most up-to-date computer aided design and manufacturing techniques to produce an extremely compact mobile radio with outstanding specifications and performance.

Your radio is designed for unobtrusive mounting in modern vehicles. With its built-in loud speaker and extremely small size, it can be mounted in almost any convenient location.

## IMPORTANT INFORMATION CONCERNING UHF CB RADIO

The use of the Citizen Band radio service is licensed in Australia by the ACMA Radio communications (Citizens Band Radio Stations) Class Licence and in New Zealand by the Ministry of Economic Development New Zealand (MED). A General User Radio Licence for Citizens Band radio and operation is subject to conditions contained in those licences.

The class licence for users and equipment operating in the CB/PRS 477 MHz band has been amended. This radio meets the new 80 channel standard.

In simple terms the same amount of spectrum is available; however, radio transceivers can now operate in a narrower bandwidth and hence use less spectrum. These radios are generally referred to as narrowband or 12.5 kHz radios. By using 12.5 kHz channel spacing instead of 25 kHz, the 40 channels originally allocated can now be expanded to 80 channels thereby doubling the channel capacity and relieving congestion in the UHF CB/PRS band.

Original 40 channel wideband Radios will continue to operate on the original 40 channels, however they will not be able to converse on the newer channels 41 – 80. The newer narrowband radios will be able to converse with all older 40 channel wideband radios on all channels 1 to 40 as well as the newer channels allocated from 41 to 80.

The mixing of narrowband and wideband radios in the same spectrum can cause some possible operating issues of interference and varying levels of received volume.

## POSSIBLE ISSUES

When a new narrowband radio receives a transmission from an older wideband radio the speech may sound loud and distorted – simply adjust your radio volume for best performance.

When an older wideband radio receives a signal from a new narrowband radio, the speech may sound quiet – simply adjust your radio volume for best performance.

Depending on how close your receiving radio is to another transmitting radio, there can be interference from the transmitting radio if it is using a channel adjacent to the channel you are listening to. Simply try going up or down a few channels from the currently selected channel.

The above situations are not a fault of the radio but a symptom of operating wideband and narrowband radios in the same bandwidth. This possible interference will decrease over time as the population of wideband radios ages and decreases.

Further information and updates are available from the Australian Communications and Media Authority (ACMA) at [www.acma.gov.au](http://www.acma.gov.au) and the Ministry of Economic Development (MED), Radio Spectrum Management at: [www.rsm.govt.nz](http://www.rsm.govt.nz)

## EMERGENCY CHANNELS

The ACMA has allocated channels 5/35 for emergency use only. Channel 5 is the primary Simplex Emergency Channel. Where a Channel 5 repeater is available, you should select Duplex on CH 5.

**NOTE:** Channel 35 is the input channel for the Channel 5 repeater therefore Channel 35 should also not be used for anything other than emergency transmissions.

## TELEMETRY CHANNELS

ACMA regulations have allocated channels 22 and 23 for telemetry only applications and have prohibited the transmission of speech on these channels. Consequently your radio has a transmit inhibit applied to channels 22 and 23.

In the event additional telemetry/telecommand channels are approved by the ACMA, these channels shall be added to those currently listed where voice transmission is inhibited. Currently transmissions on channels 61, 62 and 63 are also inhibited and these channels are reserved for future allocation

## FEATURES

### TRANSMIT (TX)

**Individually Programmable DUPLEX Function:** User selectable for only those individual channels in your area that have repeaters, leaving the others free for use as extra simplex channels.

### RECEIVE (RX)

**Silent Squelch Tail:** Eliminates the Squelch noise burst normally audible when the Squelch closes

**User Programmable Receive Channels:** 95

**Signal Receive Indicator:** Confirms that an incoming signal is being received

### SCANNING AND MEMORY FUNCTIONS

**Microprocessor Controlled Frequency Synthesiser:** Allows user programmable control of scanning, channel memories and selected feature options.

**Programmable Scan Function:** Scans the selected UHF CB channels with Group, Open and Network scan functions available.

**Priority Channel:** A user programmable Priority channel feature allows your working channel to be instantly recalled at the press of a key.

## SIGNAL PROCESSING

**Digital Signal Processing:** Measures, filters and compresses standard analogue audio signals and converts them into digital format. Allows advanced RF and audio processing techniques to be applied to maximise the radio's performance.

**Advanced Signal Management:** Identifies interference caused by strong local signals on adjacent channels and prevents these from opening your Squelch. ASM also minimises distortion on reception by fine tuning the receiver frequency to match that of the incoming signal.

**Dynamic Volume Control:** Automatically compensates for variations in received audio level to provide a constant audio output level to the speaker.

**User Selectable Wide/Narrow Band Filter:** To accommodate the blending of 80 channel/narrow band radios with older 40 channel wideband radios.

## PRIVACY FUNCTIONS

**Voice Inversion Scrambler:** When activated, scrambles your voice so that communications are only intelligible to others using the same scrambler technology.

**Inbuilt CTCSS & DCS:** User selectable Continuous Tone Coded Squelch System and Digital Coded Squelch system provides silent operation on individual channels.

**In-Built SelCall with Quiet Mode:** Provides selective calling of individuals or groups with fully user-adjustable 5-tone transmitted SelCall Ident. Also allows alphanumeric naming of up to 10 Idents for easier caller identification.

## PHYSICAL PROPERTIES

**Over Voltage Protection:** Special overvoltage detection circuitry protects the radio and warns of excessive voltage conditions by flashing the display.

**Rugged Construction:** With Die-cast Chassis

## USER CONTROLS AND INTERFACE

**Full Spectrum Backlighting:** User adjustable, totally customisable backlight settings to match the vehicles dashboard lighting or drivers preference.

**High Contrast Liquid Crystal Display:** Fully detailed LCD provides a visual indication of the selected channel and all selected functions at a glance.

**Front and Rear Microphone Inputs:** Convenient front and rear microphone inputs to facilitate ease of installation and operation across a range of vehicles.

**Digital Signal Strength Meter:** Provides a numeric signal strength indication in numbers from 0 to 9+

# GENERAL OPERATIONS

## TX3510S/TX3520S FRONT PANEL CONTROLS

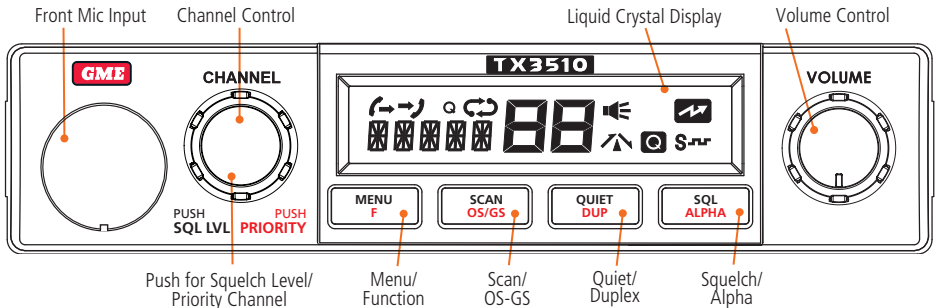

## LCD PANEL

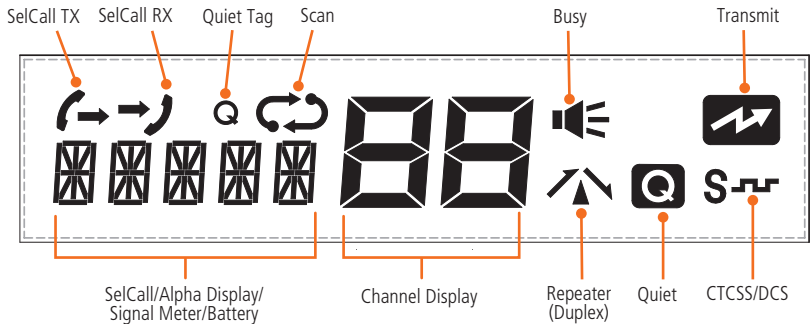

## REAR PANEL

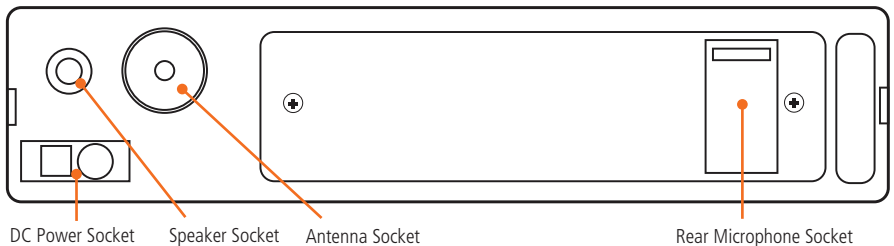

## TX3540S CONTROLLER MICROPHONE

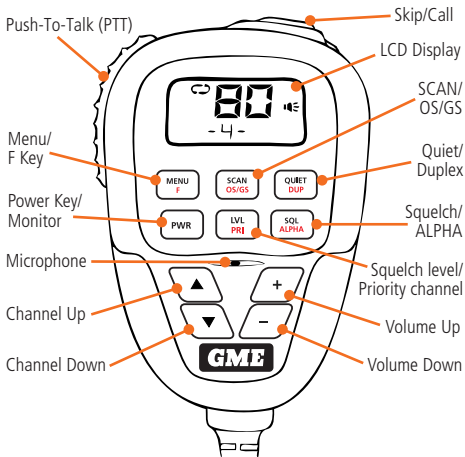

## TX3510S/TX3520S MICROPHONE

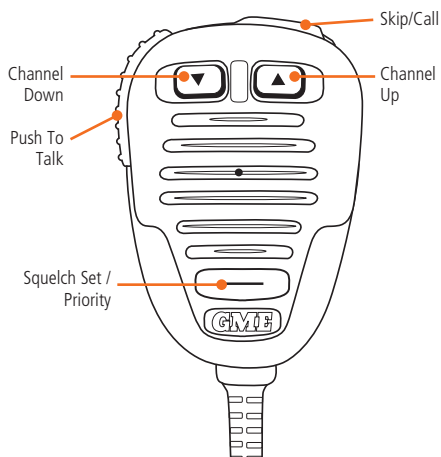

## TX3540S CONTROLLER LCD PANEL

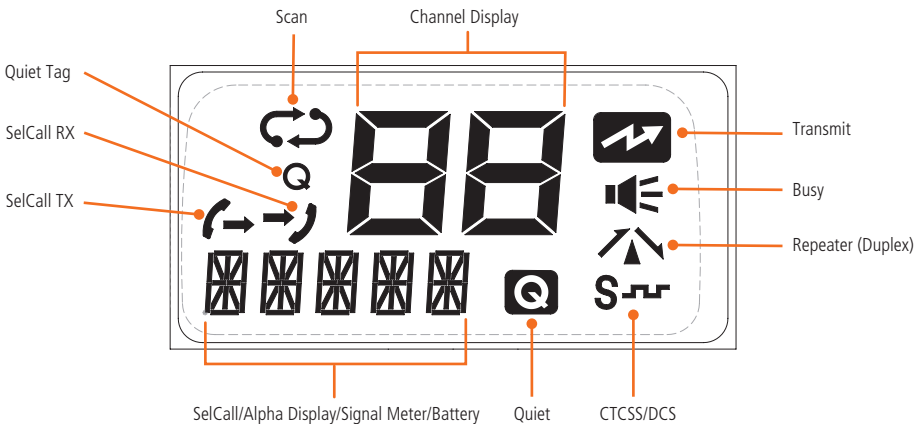















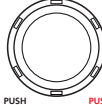

## GENERAL OPERATION ACROSS ALL MODELS

### KEYPAD FUNCTIONS

The controls on the TX3510S and TX3520S front panel and TX3540S controller microphone all have multiple functions. The primary functions are labelled in BLACK, while the secondary functions are labelled in RED. To access a primary function simply press the required key.

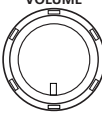
To access a secondary function, briefly press the **F** key followed immediately by the required key.

The table below shows the control functions for all models.

TX3510S/ TX3520S	TX3540S	FUNCTION
		Press and hold <b>MENU</b> to access the configuration menu. Press <b>F</b> followed by the required key to access the secondary key-functions labelled in <b>red</b> .
		Press <b>SCAN</b> to toggle scanning on or off. Press <b>F</b> followed by <b>OS/GS</b> to select Open Scan, Group Scan or Network Scan.
		Press and hold <b>QUIET</b> to tag the selected channel for use with SelCall. Press <b>QUIET</b> briefly to toggle the quiet mode on all channels that have been tagged. Press <b>F</b> followed by <b>DUP</b> to toggle duplex mode on or off on the selected channel.
		Press <b>SQL</b> briefly to toggle the Squelch on or off. Press and hold <b>SQL</b> to toggle CTCSS/DCS silent mode on or off on the selected channel. Press <b>F</b> followed by <b>ALPHA</b> to toggle Alpha or Numeric display modes.
<p style="text-align: center;">CHANNEL</p>  <p style="text-align: center;">PUSH SQL LVL      PUSH PRIORITY</p>	  	<p>Rotate the <b>Channel</b> control (or press <b>▲</b> or <b>▼</b>) to change channels.</p> <p>Press the <b>Channel</b> control (or the <b>LVL</b> key) briefly to adjust the preset Squelch level. Press <b>F</b> followed by the <b>Channel</b> control (or the <b>PRI</b> key) to recall the Priority channel.</p> <p>Press <b>F</b> then press and hold the <b>Channel</b> control (or the <b>PRI</b> key) to store the current channel as the Priority channel.</p>
<p style="text-align: center;">VOLUME</p> 	  	<p>Rotate the <b>Volume</b> control past the click (or press the <b>PWR</b> key) to switch the radio on or off.</p> <p>Rotate the <b>Volume</b> control (or press the + or - keys) to adjust the volume.</p>



**NOTE:** When using the **F** key to access other functions, **F** is displayed to indicate that 'Function' mode is activated. If the required function is not selected within 6 seconds the **F** key selection will time out with a low beep and **F** will disappear from the display.

A more detailed description of these key functions is included below. These instructions describe the radio functions using the TX3510S/TX3520S controls (with the TX3540S controls shown in brackets).

## VOLUME

Rotate the **Volume** control clockwise past the click (or press the **PWR** key) to turn the radio on. Rotate the **Volume** control left or right (or press the **+** or **-** keys) to adjust the volume.

If no sound is heard, briefly press the **SQL** key to temporarily un-mute the radio then adjust the **Volume** control while listening to the background noise. When finished, briefly press the **SQL** key again to re-mute the radio.

**NOTE:** At the minimum volume setting there is still sufficient volume to be heard in a quiet cabin environment.

## SELECTING CHANNELS

To select the required channel, rotate the **Channel** control (or press the **▲** or **▼** keys). Rotate the **Channel** control clockwise (or press **▲**) to select a higher channel or counter clockwise (or press **▼**) to select lower channels. The selected channel is displayed on the LCD.

## SQUELCH

The Squelch is used to eliminate any annoying background noise when there are no signals present. The Squelch can be opened or closed using the **SQL** key. When the Squelch is open the receiver's background noise can be heard and the **🔊** symbol is displayed. When the Squelch is closed the receiver remains quiet while there are no signals present but any incoming signals will override the Squelch and be heard in the speaker.

## Adjusting the Squelch level

The Squelch sensitivity level has been factory set to provide optimum performance under most operating conditions. If required, the sensitivity level can be adjusted to suit changing conditions.

To adjust the Squelch sensitivity, briefly press the **Channel** control (or **LVL** key). The channel display will show the current Squelch level setting in values from **SQL-1** to **SQL-9**. Rotate the **Channel** control (or press the **▲** or **▼** keys on the controller microphone) to change the Squelch setting. A Squelch setting of **SQL-1** allows the Squelch to open on very weak signals whereas a setting of **SQL-9** requires much stronger signals to overcome the Squelch. After adjusting the Squelch sensitivity, briefly press the **Channel** control (or **LVL** key) to return to normal operation.

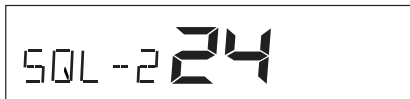

**NOTE:** The Squelch level can be actively adjusted while the radio is scanning. This allows you to tighten the Squelch in cases where an undesired weak or noisy signal is interrupting the scan.

## SIGNAL METER

The signal meter indicates the relative strength of the incoming signal in numerical format. Signal strengths are displayed on the lower left of the Channel Display in values from 0 to 9. Signals above strength 9 are displayed as 9+.

**NOTE:** Refer to the **Configuration Menu** for other options that can be displayed in this location.

## TRANSMITTING

Prior to transmitting, always check the channel is not being used. This can be done by listening to the channel or by visually checking that the **🔊** icon is not visible or the signal meter is not indicating a signal.

To transmit, press the **PTT** on the microphone. The **🗣️** icon will appear. Hold the microphone about 5-8 cm from your

face and speak at a normal voice level. The microphone is quite sensitive so it is not necessary to raise your voice or shout. Release the **PTT** when you have finished talking. The  icon will disappear.

---

**IMPORTANT:** Always listen to ensure the channel is free before transmitting.

---

## TIME-OUT TIMER

---

The radio has a built-in time-out timer that automatically limits transmissions to a maximum of 3 minutes of continuous operation. This feature is required by the ACMA to prevent accidental blocking of the frequency should your **PTT** become jammed or be otherwise pressed accidentally. The time-out period can be changed by your dealer.

When the time-out timer activates, the radio will beep for 5 seconds then the  symbol will flash continuously. Normal operation will be restored once the **PTT** is released.

## BACKLIGHTING

---

The Liquid Crystal Display and keys are backlit for easier viewing at night. The backlight remains on whenever the radio is switched on.

### Adjusting the Backlighting

---

The backlight brightness and colour can be adjusted for personal preference. There are three backlight settings available.

**BKLG (Brightness setting):** Provides a continuously variable brightness adjustment from very dim to full brightness.

**COLOR (Colour setting):** Provides a continuously variable adjustment through the full colour spectrum.

**White (Whiteness setting):** Controls the colour saturation of the selected colour from deep colour to white (no colour).

To adjust the backlighting;

1. Hold the **Channel** control (or **LVL** key) to select the Backlight mode. 'BKLG' is displayed.

2. Rotate the channel control left or right (or press ▲ or ▼ keys) to adjust the brightness.
3. Briefly press the **Channel** control (or **LVL** key) to select the Colour setting mode. 'COLOR' is displayed.
4. Rotate the **Channel** control left or right (or press ▲ or ▼ keys) to adjust the colour.
5. Briefly press the **Channel** control (or **LVL** key) to select the Whiteness setting mode. 'WHITE' is displayed.
6. Rotate the **Channel** control left or right (or press ▲ or ▼ keys) to adjust the colour saturation. For the deepest colour range, reduce the WHITE setting.

To exit, press and hold the **Channel** control (or **LVL** key).

## Auto-colour Mode

---

The radio has an automatic colour-change option that, when activated, will cause the display colour to automatically cycle through the available colour spectrum. The colour-change option can be enabled temporarily as an aid to choosing a display colour or can be set to cycle continuously as the preferred display colour setting.

To enable the auto-colour option,

7. Hold the **Channel** control (or **LVL** key) to select the Backlight mode. 'BKLG' is displayed.
8. Briefly press the **Channel** control (or **LVL** key) to select the Colour setting mode. 'COLOR' is displayed.
9. While in the colour setting mode, briefly press the **MENU** key to enable or disable the auto-colour option. When enabled, the display lighting will continuously cycle through the available colour spectrum. When disabled the display will hold the last selected colour.

To exit, press and hold the **Channel** control (or **LVL** key). If auto-colour is still enabled, the display lighting will continue to cycle through the colour spectrum until disabled using the steps above.

---

**NOTE:** The back-light setting function will automatically time out after 6 seconds if no further adjustments have been made.

---

## BANDWIDTH FILTER SETTINGS

To accommodate the blending of newer 80 channel narrowband UHF radios with the original 40 channel wideband radios, your radio has been fitted with two user selectable receiver bandwidth filters. While the use of either filter will provide superb receive audio, selecting the wideband filter while on channels 1-40 will further increase your receiver's tolerance to older 40 channel wideband radios that might otherwise sound over-modulated or mildly distorted. Select the narrowband filter to improve the selectivity of the receiver to provide greater resistance to interference from older 40 channel wideband radios operating on adjacent channels.

To select the desired filter

1. Press and hold **MENU** to enter the menu.
2. Press **MENU** repeatedly until 'NBFLT' (Narrowband Filter) or 'WBFLT' (Wideband Filter) is displayed.
3. Rotate the **Channel** control (or press ▲ or ▼ keys) to make the desired selection.

When finished briefly press the **PTT** to exit the menu.

Narrowband filter selected

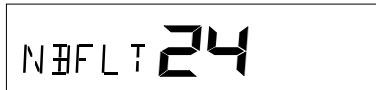

Wideband filter selected

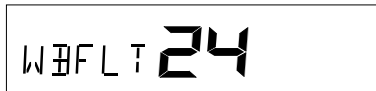

**NOTE:** The wideband receiver filter setting is only applied to channels 1 – 40. Channels 41 – 80 always use the narrowband filter.

## DYNAMIC VOLUME CONTROL (DVC)

The modulation level of signals heard on the UHF CB band has always varied considerably resulting in noticeable

differences in received audio volume between stations. Generally users have compensated for this by adjusting the **Volume** control for each incoming signal. With the introduction of 80 channel narrowband transmissions that use lower levels of modulation, the diversity in received audio volume is likely to increase further.

Your radio is able to automatically compensate for these variations in received audio level by utilising a **Dynamic Volume Control**. When activated, this feature automatically compensates for variations in received audio level resulting in a constant audio output level to the speaker.

To activate the Dynamic Volume Control

1. Press and hold **MENU** to enter the menu.
2. Press **MENU** repeatedly until 'DVCOF' (Dynamic Volume Control Off) or 'DVCON' (Dynamic Volume Control On) is displayed.
3. Rotate the **Channel** control (or press ▲ or ▼ keys) to make the desired selection.

When finished briefly press the **PTT** to exit the menu.

Dynamic Volume Control ON



Dynamic Volume Control OFF



## VOICE SCRAMBLER

Your radio incorporates a simple voice scrambler using band inversion. The scrambler is compatible with the majority of scramblers used by other manufacturers, allowing you to enjoy scrambled communications with owners of non-GME radios. Once the scrambler has been activated your transmission and reception will only be intelligible to others using the same scrambler technology.

To enable or disable the voice scrambler

1. Press and hold **MENU** to enter the menu.
2. Press **MENU** repeatedly until 'ENCOF' (Encoder Off) or 'ENCON' (Encoder On) is displayed.
3. Rotate the **Channel** control (or press ▲ or ▼ keys) to make the desired selection. Select 'ENCON' to activate the scrambler or 'ENCOF' to disable it.

When finished briefly press the **PTT** to exit the menu.

ENCOF

Scrambler Encoder OFF

ENCON

Scrambler Encoder ON

## BEEP TONE VOLUME

The Key Beeps provide audible feedback whenever the keys are pressed. You can adjust the volume of the key beeps as follows.

1. Press and hold **MENU** to enter the menu.
  2. Press **MENU** repeatedly until 'BEEPx' is displayed (where x is a value from 0 – 9).
  3. Rotate the **Channel** control (or press the ▲ or ▼ keys) to adjust the Beep volume from 0 – 9.
- BEEP1 = minimum
  - BEEP9 = maximum
  - BEEP0 = Off

When finished, briefly press the **PTT** to exit.

## SILENT SQUELCH TAIL

The Squelch Tail is the short burst of noise that is heard in the speaker at the end of a transmission just before the Squelch closes.

To some it is a reassuring confirmation that it is their turn to transmit but in some applications it may be an annoyance especially when listening through an earpiece or headphones.

The Silent Squelch Tail function removes this Squelch Tail, reducing it to a faint click as the Squelch closes.

To enable or disable the Silent Squelch Tail

1. Press and hold **MENU** to enter the menu.

2. Press **MENU** repeatedly until 'SSTxx' is displayed where xx = ON or OF.
3. Rotate the **Channel** control to the right (or press the ▲ key) to enable the Silent Squelch Tail. 'SSTON' will be displayed and the Squelch Tail will become silent.
4. Rotate the **Channel** control to the left (or press the ▼ key) to disable the Silent Squelch Tail. 'SSTOF' will be displayed and the Squelch Tail will be restored.

When finished, briefly press the **PTT** to exit.

## REPEATERS AND DUPLEX MODE

Duplex operation allows the radio to transmit on a different frequency to that which it receives. This allows operation through repeater stations.

A repeater station consists of a linked transmitter/receiver combination installed in a prominent location. The repeater is designed to receive signals on a designated channel and retransmit them on another channel. Repeaters are usually mounted on hills or tall buildings. The increase elevation greatly improves both the receiving and transmitting range of the repeater allowing it to receive and retransmit signals to radios that would otherwise be out of range of each other.

Normally, UHF radios transmit and receive on the same frequency – known as Simplex operation. However to communicate through repeaters, your radio must be able to transmit and receive on different channels – otherwise known as Duplex operation. Your radio is fitted with a Duplex key to allow you to operate through repeaters.

The Duplex function can only be selected on channels 1 – 8 and 41 – 48 as these are the channels that have been allocated for repeater use. When Duplex is selected, your radio receives on the selected channel (e.g. CH 1) but transmits 30 channels higher (CH 31). The repeater hears your signal on CH 31 and retransmits it on CH 1 for others to hear.

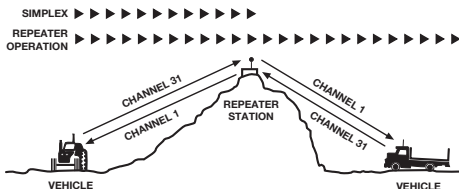

Your radio allows you to enable or disable Duplex mode on individual repeater channels. In this way any repeater channels that are not being used with repeaters in your area can be used in Simplex mode for normal direct radio-to-radio communications.

Channel Selected	Receive Channel	Transmit Channel
1	1	31
2	2	32
3	3	33
4	4	34
5*	5*	35*
6	6	36
7	7	37
8	8	38
41	41	71
42	42	72
43	43	73
44	44	74
45	45	75
46	46	76
47	47	77
48	48	78

\*Emergency channel only

### To Enable Duplex on a Repeater Channel

1. Select the required repeater channel (1 – 8, 41 – 48).
2. Press **F** followed by the **DUP** key. The duplex symbol  will appear on the display accompanied by a high beep.

### To Remove Duplex from a Repeater Channel

1. Select the required repeater channel (1 – 8, 41 – 48). If duplex is currently selected, the  duplex symbol will be displayed.

2. Press **F** followed by the **DUP** key. The duplex symbol  will disappear from the display accompanied by a low beep.

**IMPORTANT:** Channels 1 – 8, 31 – 38, 41 – 48 and 71 – 78 should only be used in Simplex mode if there are no repeaters in or near your location that operate on the selected channel. In particular, avoid operating in Simplex mode on any of the repeater input channels 31 – 38 and 71 – 78 unless you are absolutely sure that there are no repeaters in range using that channel. Inadvertently transmitting on an active repeater input frequency in simplex mode could cause interference to other users on that repeater that would not be audible to your radio.

### PRIORITY CHANNEL

The Priority channel feature allows you to instantly recall any one of the 80 channels in your radio. This feature can be used to provide instant access to your working channel or your local repeater channel at the press of key. It is also used in conjunction with the Group Scan mode.

#### To Store a Priority Channel

1. Select the required channel.
2. Press **F** then press and hold the **Channel** control (or **LVL** key). The channel number will flash then a high beep will be heard as the channel is stored.

#### To Recall a Priority Channel

1. Press **F** then briefly press the **Channel** control (or **LVL** key). The radio will immediately switch to the Priority channel and 'PRI' will be displayed for a few seconds.

**NOTE:** If the radio was scanning when the Priority channel was recalled, the scan will be cancelled.

### SCANNING

Your radio incorporates a scan function allowing selected groups of channels to be scanned for signals. Channels can be scanned at a rate of 40 channels per second. When a signal is found, scanning will pause to allow the signal to be heard then resume scanning when the channel is clear again.

## Scan Groups

Your radio supports three scan groups - Open Scan, Group Scan and Network Scan. Each scan group has a separate channel memory allowing you to program your choice of channels into each group for scanning.

To select Open Scan, Group Scan or Network Scan, press **F** then **OS/GS**. 'OPEN', 'GROUP' or 'NETWK' will be displayed at each press.

**NOTE:** Network scan is disabled by default and will not appear in the scan group list unless it has been enabled. See **Network Scan** further below for details on how to enable and use Network Scan.

## Auto Skip

While scanning, if an active channel in your scan group becomes a nuisance by constantly interrupting the scan, briefly rotate the **Channel** control (or press **▲** or **▼** keys) while the radio is paused on that channel. The busy channel will be temporarily removed from the scan group to allow time for the channel to become clear again and scanning will continue from the next channel in the sequence. After 30 seconds the skipped channel will be reinstated in the scan sequence.

If the unwanted active channel continues to interrupt the scan even after the 30 second skip period has elapsed, hold **SCAN** while the radio is paused on that channel. The 'nuisance' channel will be completely removed from the scan group for the duration of that scan session. To restore the channel, simply stop and restart the scan session using the **SCAN** key (or switch the radio Off then On again).

**NOTE:** You can skip as many busy channels from the scan group as you wish, however if you attempt to skip the last remaining channel, all the previously skipped channels will be restored to the scan group.

## OPEN SCAN

Open Scan allows a group of channels to be scanned in an ascending sequence. If a signal is found, the scan will pause on that channel. During this time you can press the **PTT** on the microphone and talk on the channel. Once the channel has been clear for 5 seconds the scan will resume.

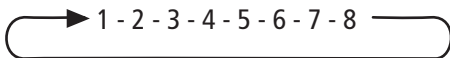

### Example: Scanning channels 1 – 8 in Open Scan





#### Selecting Open Scan

To select Open Scan, repeatedly press **F** followed by **OS/GS** until 'OPEN' is displayed.

#### Programming the Scan Memory

Your radio has all 80 channels factory-programmed into the Open Scan memory. Any channels not required can be removed.

To add or remove channels from the Open Scan memory:

1. Select the required channel using the **Channel** control (or the **▲** or **▼** keys)
2. Check to see if the scan symbol  is displayed on that channel.
  - If  is displayed, the selected channel is already in the scan memory. To remove it, press and hold **SCAN**.  will disappear.
  - If  is not displayed, the selected channel is not in the scan memory. To add it, press and hold **SCAN**.  will now be displayed on that channel.

Repeat to add or remove other channels in the scan memory.

#### Default Working Channel in Open Scan Mode

In the Open Scan mode, your default working channel is the channel your radio switches to when you press the **PTT** while scanning. To define your working channel simply select the required channel before you press **SCAN**. e.g. to make channel 24 your working channel, simply select channel 24 before pressing **SCAN**.

## To Begin Scanning

Briefly press **SCAN**. A high beep will be heard and the  symbol will animate. During this time the channel numbers will scroll rapidly as the channels are scanned.

**NOTE:** If there are less than 2 channels programmed into the scan memory when you press **SCAN**, a low beep will sound and the command will be ignored.

## Operating in the Open Scan Mode

If a busy channel is found, scanning will pause to allow the signal to be heard and will remain there for as long as the channel remains busy. Once the channel has been clear for 5 seconds, scanning will resume automatically.

If you don't wish to listen to a busy channel, briefly rotate the **Channel** control (or press the **▲** or **▼** keys) while the radio is paused on that channel. The busy channel will be temporarily removed from the scan group to allow time for the channel to become clear again and scanning will continue. The skipped channel will be reinstated in the scan sequence after 30 seconds (see **Auto Skip**).

If you press the **PTT** while the radio is scanning, the scan will pause and the radio will transmit on the working channel. After the channel has remained clear for 5 seconds scanning will resume.

If your radio pauses on a busy channel and you wish to talk on that channel, simply press the **PTT** during a break in the conversation. If the busy channel was not your working channel, it now becomes your new working channel, replacing your previous working channel. Once your communication has finished and the channel has been clear for 5 seconds, scanning will resume.

If you need to use your Priority channel (for an urgent call), briefly press **PRI**. The scan will be cancelled and the radio will jump straight to the Priority channel.

## GROUP SCAN

Group Scan allows you to scan a number of channels for activity while also monitoring your Priority channel. The receiver will scan the other channels **ONLY WHILE THERE**

ARE NO SIGNALS ON THE PRIORITY CHANNEL. If a signal appears on the Priority channel it will override any signals being received on any of the other channels. In addition, if you press the **PTT** at any time, the radio will transmit on the Priority channel.





▶ 1 - 2 - 3 - 4 - 20 - 5 - 6 - 7 - 8 - 20

**Example: Scanning channels 1 – 8 with priority channel 20 in Group Scan**

## Selecting Group Scan

To select Group Scan, repeatedly press **F** followed by **OS/GS** until 'GROUP' is displayed.

## Programming the Scan Memory

1. Select the required channel using the **Channel** control (or the **▲** or **▼** keys).
2. Check to see if the scan symbol  is displayed on that channel.
  - If  is displayed, the selected channel is already in the scan memory. To remove it, press and hold **SCAN**.  will disappear.
  - If  is not displayed, the selected channel is not in the scan memory. To add it, press and hold **SCAN**.  will now be displayed on that channel.

Repeat to add or remove other channels in the scan memory.

## Select your Priority Channel

Program your Priority channel as described earlier under 'Priority Channel'

## To Begin Scanning

Briefly press **SCAN**. A high beep will be heard and the  icon will animate. During this time the channel numbers will change rapidly as the channels are scanned with the Priority channel scanned every fourth channel.

If a signal appears on the Priority channel – at any time – the radio will switch directly to the Priority channel and will stay

there for as long as the channel remains busy. During this time you can transmit and receive on the Priority channel. Once the Priority channel has been clear for 5 seconds the radio will resume scanning the other channels.

If a signal appears on any other channel, scanning will pause on that channel and will remain there while the channel is busy – as long as there are no signals on the Priority channel. During this time, the receiver will continue to check the Priority channel every 2 seconds resulting in a series of small breaks in the reception of the busy channel. Once the signal has gone and there has been no activity for 5 seconds, the radio will resume scanning.

To transmit on the Priority channel at any time, simply press the **PTT**. The radio will switch straight to the Priority channel. When you have finished your conversation and there has been no further activity for 5 seconds, the radio will resume scanning the other channels.

If you don't wish to listen to a busy channel, briefly rotate the **Channel** control (or press the **▲** or **▼** keys) while the radio is paused on that channel. The busy channel will be temporarily removed from the scan group to allow time for the channel to become clear again and scanning will continue. The skipped channel will be reinstated in the scan sequence after 30 seconds (see **Auto Skip**).

If you need to use your Priority channel (for an urgent call), briefly press the **PRI** key. The scan will be cancelled and the radio will jump straight to the Priority channel.

If the radio is paused on a busy channel and you want to remain there, briefly press **SCAN**. The radio will exit scan and remain on the busy channel. At this point you will no longer be monitoring the Priority channel.

To resume Group scanning press **SCAN** again.

## NETWORK SCAN (NET-SCAN)

---

Net-Scan allows a group of radio users to maintain communications even when the band is congested. To achieve this all members of the Net-Scan group must share a common CTCSS/DCS code and a common set of scan channels.

Once activated, Net-Scan's intelligent scanning software keeps track of clear channels within your scan group. When

any member of the group transmits, their radio automatically selects a clear channel to transmit on. Other radios scanning in the same Net-scan group will lock onto that channel allowing all members of the group to join the conversation. If a signal from outside your Net-Scan group appears on the chosen channel (either with no code or the wrong code), the group will automatically switch to a new clear channel at the next transmission. In this way the group can continue to communicate with minimal interference to or from other users.

## Enabling Net-Scan

---

Net-Scan is normally switched off by default but can be enabled through your radio's menu.

**NOTE:** When you enable Net-Scan you will also be prompted to choose a suitable CTCSS or DCS tone to be used by your Net-Scan group. All members of your Net-Scan group must use this same code.

## To Enable Net-Scan

---

1. Press and hold **MENU** to enter the menu.
  2. Press **MENU** repeatedly until 'NS xxx is displayed.
  3. Rotate the **Channel** control (or press the **▲** or **▼** keys) to change the current Net-Scan setting.
- To enable Net-Scan using CTCSS, select from NS-01 to NS-50 (CTCSS tones 01 to 50).
  - To enable Net-Scan using DCS, select from NS001 to NS104 (DCS codes 001 to 104).
  - To disable Net-Scan, select 'NS-OF'.

When finished briefly press the **PTT** to exit the menu.

## Selecting Net-Scan

---

When Net-Scan is enabled, a Network scan option becomes available in the scan group selection. To select Network Scan, repeatedly press **F** followed by **OS/GS** until 'NETWK' is displayed.

## Programming Channels into Net-Scan

---

All radios in your Net-Scan group must have the same channels programmed into their Net-Scan memory.







Your radio's Net-Scan memory has already been factory programmed with 43 of the available 80 channels. The remaining 37 channels, which consist of the 32 repeater input/output channels, 2 telemetry channels and 3 guard-band channels, have not been included to minimise the risk of interference to other services on these channels.

### To Add or Remove Net-Scan Channels

---

With Net-Scan mode enabled,

1. Select the required channel using the **Channel** control (or the ▲ or ▼ keys).
2. Check to see if the scan symbol  is displayed on that channel.
  - If  is displayed, the selected channel is already in the scan memory. To remove it, press and hold **SCAN**.  will disappear.
  - If  is not displayed, the selected channel is not in the scan memory. To add it, press and hold **SCAN**.  will now be displayed on that channel.

Repeat to add or remove further Net-Scan channels.

---

**IMPORTANT:** When adding channels to Net-Scan, please consider the following:

---

- The transmitter on your radio is inhibited on channels 22, 23 and channels 61, 62, 63 as required by the ACMA. This makes these channels unsuitable for use as Net-Scan channels.
- You should not include any repeater channel unless you have confirmed that the channel is not allocated to a repeater in your area. Using an active repeater channel in Net-Scan may result in interference to other repeater users on that channel.

### Starting Net-Scan

---

With Net-Scan mode enabled, press **SCAN**. A high beep will be heard and the  icon will animate. During this time the channel numbers will change rapidly as the channels are scanned.

### Using Net-Scan

---

When a member of the group initiates a transmission their radio will automatically select a clear channel to transmit on. Other radios scanning in the same Net-Scan group will locate the transmission by identifying the groups CTCSS/DCS code and open their Squelch allowing the transmission to be heard across the entire group. When the transmission ends, all radios in the group will immediately resume scanning.

If a member of the group responds to the initial transmission, they will automatically re-use the same channel as long as the channel remains free of other signals. This allows the radios in the group to respond more quickly to further transmissions from others in the group.

If at any time, a signal from outside your Net-Scan group appears on the channel (either with no code or the wrong code), the channel will be discarded and a new clear channel will be selected at the next transmission. The other radios in the group will then locate the new channel allowing the conversation to continue seamlessly without any input from the user.

### Ending the Scan

---

To stop scanning, briefly press **SCAN**. A low beep will be heard and the animated  icon will stop. As long as the radio was not on a busy channel, it will return to the last channel you selected, otherwise it will stay on the busy channel.

### Quick select/check

---

To quickly switch between channels that have been stored in the current scan memory, briefly press the **F** key then rotate the **Channel** control (or press ▲ or ▼ keys). This will allow you to manually step through only those channels that have been stored in the current scan group memory. During this time **F** will remain on the display to confirm you are still in 'Quick Select' mode. To exit this mode, press the **F** key again or wait 10 seconds for the function to time out.

This option can be used to quickly jump between channels of interest or to quickly review which channels are in the scan memory for editing purposes.

## CTCSS AND DCS

The standard Squelch system is fine for quieting the radio in most applications. However, it operates solely on signal strength which means that it will always open to any signal that is strong enough. If the channel is busy with other stations the Squelch will be constantly opening making it difficult to determine which calls are meant for you.

CTCSS (Continuous Tone Coded Squelch System) and DCS (Digital Coded Squelch) are similar Squelch quieting systems that provide selective audio muting using sub-audible signalling. When enabled, only signals with a matching sub-tone will be heard in the speaker. This effectively creates a channel that is silent to all traffic except those you wish to hear.

### Choosing CTCSS or DCS

The CTCSS system uses 1 of 50 low frequency tones to open and close the Squelch on the radio. The DCS system is similar to CTCSS but uses 1 of 104 digital codes to control the Squelch. There is no difference in performance or function between the different tone sets so choosing which tone system to use will largely depend on the other radios you talk with. If others already use CTCSS or DCS, you should select the tone system that matches theirs. If the users you talk to don't currently use CTCSS or DCS then you can make your own choice. Both types are included in the radio to maintain compatibility with other radio systems.

### CTCSS Tone Set Compatibility

The GME CTCSS tone set comprises a table of 50 tones made up of the standard CCIR-38 Tone Set plus an additional 12 tones added to the end. If communicating with other brands of radios that only use the CCIR-38 tone set, please select from one of the first 38 tones to ensure compatibility with these radios.

If communicating with other GME radios, you may choose from any of the 50 tones. However, please refer to the tone set tables listed in each radio's Instruction manual for compatibility because, although the same 50 tones are available in all GME radios, the tones used in older GME models may be listed in a different order to those in your radio.

To select a CTCSS or DCS code

1. Press **MENU** to enter the menu. 'CTCxx' or 'DTxxx' will be displayed.
2. Rotate the **Channel** control (or press the **▲** or **▼** keys) to enable CTCSS/DCS and select a suitable CTCSS or DCS code.
  - To select a CTCSS tone, select from 'CTC01' to 'CTC50' (CTCSS tones 01 to 50).
  - To select a DCS code, scroll past CTC50 to select from 'DT001' to 'DT104' (DCS codes 001 to 104).
  - To switch CTCSS/DCS off, select 'CTCOF'.

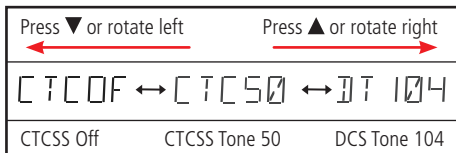

3. To see the actual sub tone instead of the tone table, briefly press the **Channel** control (or **LVL** key). For CTCSS tones the tone frequency will be displayed in Hz. For DCS codes the code will be displayed. Press the **Channel** control (or **LVL** key) again to return to the CTCSS/DCS label (refer to the CTCSS and DCS tone charts later in this manual).

CTC50

CTCSS Label

254.1

CTCSS Sub Tone Frequency

When finished briefly press the **PTT** to exit the menu.

**NOTE:** The tone you select will be used for all channels that have 'Silent' enabled.

## Enabling CTCSS/DCS on a Channel (Silent mode)

Enabling CTCSS/DCS on a channel will prevent the Squelch from opening on that channel unless the incoming signal matches your selected CTCSS/DCS tone. Other users on the same channel who are not using your CTCSS/DCS tone will still be received by your radio (the  icon will still appear on the display) – but their voice will not be heard in the speaker. Only when someone transmits on the channel using your CTCSS/DCS tone will the Squelch open to allow the signal to be heard. Channels where CTCSS/DCS have been enabled are said to be in ‘Silent mode’.

**NOTE:** Silent mode can be enabled on any channel except emergency channels 5 and 35.

### To Enable Silent Mode on a Channel:

1. Select the required channel.
2. Press and hold the **SQL** key until a high beep is heard.
3. An **S** icon (CTCSS) or **S-DCS** icon (DCS) will be displayed in the lower right of the display to indicate Silent mode is now enabled on that channel.

**NOTE:** You cannot enable Silent mode unless a CTCSS or DCS tone has been selected in the Configuration menu. If CTCSS/DCS has been set to OFF, Silent mode is inhibited.

### To Disable Silent Mode on a Channel:



1. Select the required channel. An **S** icon (CTCSS) or **S-DCS** icon (DCS) will be displayed indicating Silent mode is enabled.
2. Press and hold the **SQL** key until a low beep is heard.
3. The **S** (CTCSS) or **S-DCS** (DCS) icon will disappear to indicate Silent mode has been removed from that channel.

**IMPORTANT:** When Silent mode is enabled on a channel you should always check the  icon for signs of traffic on the channel before transmitting to ensure you do not accidentally transmit over the top of another user. Alternatively, you can enable **Busy Lockout** in the **Configuration Menu** which

will automatically prevent your radio from transmitting if the channel is already in use



## Busy Lockout

When using Silent mode with CTCSS/DCS, your radio’s receiver remains quiet to all signals outside your CTCSS/DCS group. As a result, if you do not notice when others are transmitting on your channel you could accidentally transmit over the top of them.

The Busy Lockout function detects when others outside your CTCSS/DCS group are transmitting on the channel and prevents your radio from transmitting over them. If the channel is busy and you press the **PTT** the radio will emit a warning beep and the  icon won’t be displayed. When you release the **PTT**, look for the  icon on the display as an indicator that the channel is in use. If the channel is busy, simply wait until the channel is clear and press the **PTT** again.

**NOTE:** You can also press the **Monitor** key to open the Squelch and listen for signals on the channel before transmitting (see Monitor Function directly below).

To enable Busy Lockout

1. Press and hold **MENU** to enter the menu.
2. Press **MENU** repeatedly until ‘BLKxx’ is displayed (where xx is ‘ON’ or ‘OF’.
3. Rotate the **Channel** control to the right (or press the  key) to enable Busy Lockout. ‘BLKON’ will be displayed.
4. Rotate the **Channel** control to the left (or press the  key) to disable Busy Lockout. ‘BLKOF’ will be displayed.

When finished, briefly press the **PTT** to exit.

## Monitor Function

When the current channel is in Silent mode, the  icon may appear but no sound will be heard in the speaker. This indicates that your radio is receiving a signal that does not match your CTCSS/DCS tone. If you wish, you can briefly monitor the channel as described below. This temporarily disables Silent mode, allowing the signal to be heard.

On the TX3510S and TX3520S, press and hold the **Volume** control to monitor signals on the channel. When you release the **Volume** control, Silent mode is restored and the radio will become quiet again.

On the TX3540S briefly press the **PWR** key.

**NOTE:** On the TX3540S you will only have a brief moment to monitor the channel for signals as holding the **PWR** key for more than a few seconds will switch the radio off.

## SELECTIVE CALLING

Your radio has a Selective Calling system known as SelCall that operates like a telephone. Your radio is pre-programmed with its own unique SelCall Identification number. If this number is called by another radio, your radio will beep to alert you. If you do not want to hear any other activity while waiting on a channel, you can select the QUIET mode. Your radio will then remain quiet to all incoming signals until your SelCall number is called.

Your radio will allow you to store up to 10 of your most frequently called SelCall numbers in memory and each number can be labelled for easy identification.

### SelCall Identification Number

Your radio is factory programmed with its own unique SelCall Identification Number (Ident). This number identifies your radio from others in your area. Your radio's own SelCall Ident will be displayed for a few seconds to the left of the channel display when you first turn the radio on. You will need to make your Ident known to anyone who may need to call you using SelCall.

**NOTE:** Although your radio is factory-programmed with a unique SelCall Ident, you can change your Ident to another number if required (see **SelCall Memories** on next page).

### SelCall Ident Labels

When storing SelCall Idents, you can add labels to each one to make it easier to identify whose Ident you are recalling. In addition, if an incoming SelCall matches one of your stored Idents, the label can be displayed instead of the Ident.

To add or display labels, your radio must be in the ALPHA mode. To switch between ALPHA mode and NUMERIC mode, briefly press the **F** key followed by the **ALPHA** key. 'ALPHA' or 'NUMER' will be displayed briefly to the left of the channel display to indicate the selected mode.

## The QUIET Mode

Your radio can be set to monitor signals on a busy channel but remain QUIET unless it receives its own SelCall Ident. In this way, you won't be disturbed unless someone calls you. When your SelCall Ident is received, the QUIET mode is deactivated and an alarm sounds to alert you to the call. You can then converse normally on the channel. To use the QUIET mode, refer to the QUIET mode section further below.

**NOTE:** The QUIET mode overrides the normal Squelch system to ensure that the radio remains quiet even when the channel is busy. When QUIET is set, you may see the  icon appear on the display indicating the channel is being used. However, unless someone transmits your SelCall Ident, nothing will be heard in the speaker.

You can activate the QUIET mode on individual channels i.e. some channels can be set to remain Quiet while others can remain open to all incoming signals.

## USING SELCALL

### Entering a SelCall Ident

1. Press **CALL**.  is displayed, along with the last SelCall Ident. If an ALPHA label is displayed you will need to press **F** then **ALPHA** to switch to Numeric mode.
2. Press and hold the **Channel** control (or **LVL** key) until the radio beeps. The right-hand digit of the SelCall Ident will flash.
3. Rotate the **Channel** control (or press **▲** or **▼**) to select the required number in the flashing digit position.
4. Briefly press the **Channel** control (or **LVL** key) again to select the next digit position.
5. Repeat steps 3 and 4 to enter all 5 digits as required. The SelCall number is now ready to send.
6. Press and hold **CALL**. A beep will be heard and the radio will transmit the SelCall Ident.

**NOTE:** If the call is not sent within 10 seconds of entering the last Ident digit the Call function will time out and the radio will return to normal mode. To exit the  mode without sending the SelCall briefly press CALL.

## Call Acknowledge





If your SelCall transmission is successful, the radio you called should respond with an 'acknowledge' signal – usually 2 quick beeps. This will confirm to you that the radio you called is now alerting its user to your signal.

## SelCall Memories

Your radio is fitted with one 'Call' memory and 10 user programmable SelCall memories labelled 'C0' to 'C9'. There is also one additional location labelled 'Id'.

Memory locations 'C0' to 'C9' are for storing frequently called SelCall Idents. The additional location labelled 'Id' contains your radio's own SelCall Ident. You should only select this memory location if you need to change your radio's factory programmed SelCall Ident.



## To Store a SelCall Ident in Memory

1. Briefly press CALL.  is displayed along with the last sent SelCall Ident.
2. Rotate the **Channel** control clockwise (or press ) to select the required Ident memory location 'C0' to 'C9' (or select 'Id' to change your radios own SelCall Ident). If an ALPHA label is displayed you will need to press **F** then **ALPHA** to switch to Numeric mode.
3. Press and hold the **Channel** control (or **LVL** key) until the radio beeps. The right-hand digit of the SelCall Ident will flash.
4. Rotate the **Channel** control (or press  or ) to select the required number in the flashing digit position.
5. Briefly press the **Channel** control (or **LVL** key) again to select the next digit position.
6. Repeat steps 4 and 5 to enter all 5 digits as required.
7. Now press and hold the **Channel** control (or **LVL** key). The entire Ident will flash for a few seconds then the radio will beep as the new Ident is stored.

e.g. Programming Call Memory C5







## Recalling SelCall Idents

1. Briefly press CALL.  is displayed along with the last sent or received SelCall Ident.
2. Rotate the **Channel** control (or press  or ) to select the required Ident memory in locations 'C0' to 'C9'.
3. Press and hold CALL to send the Ident.

## Naming Your SelCall Idents

Your radio allows you to label each SelCall Ident using a 5 character name to make it easier to identify callers. If an incoming SelCall matches one of those in your radio's memory, the label can be displayed instead of the SelCall Ident.

**NOTE:** Before adding an ALPHA label to a SelCall Ident, you must first store the required Ident in memory as described left.

1. Briefly press CALL.  will be displayed along with the last sent SelCall Ident.
2. Rotate the **Channel** control (or press  or ) to select the required Ident memory in locations 'C0' to 'C9'.
3. Briefly press the **F** then **ALPHA** to select the ALPHA mode. 'ALPHA' will be displayed briefly.
4. If the ALPHA label is empty, '- - - - -' will be displayed, otherwise it will display the last ALPHA label programmed into that memory.
5. Press and hold the **Channel** control (or **LVL** key) until the radio beeps. The left-hand position of the Alpha label will flash.
6. Rotate the **Channel** control (or press  or ) to select the required character in the flashing position then briefly press the **Channel** control (or **LVL** key) again to select the next position.

- Repeat step 6 to enter up to 5 characters as required.
- Now press and hold the **Channel** control (or **LVL** key).  
The entire Alpha label will flash for a few seconds then the radio will beep as the label is stored.

e.g. Labelling Call memory C5



Repeat steps 2 to 8 to add ALPHA labels to any other SelCall Idents stored in memory. The following characters are available;

<b>Letters</b>	A B C D E F G H I J K L M N O P Q R S T U V W X Y Z
<b>Numbers</b>	0 1 2 3 4 5 6 7 8 9
<b>Punctuation</b>	. <space> * + -

To exit the **CALL TO mode**, briefly press **CALL** (or simply wait for the Call function to time out). The radio will return to normal operation.

To display the Alpha labels of incoming SelCalls, the radio should be left in Alpha mode. Any incoming SelCall that does not match those in the memory will display **-NEW-**. To display the SelCall Ident of that caller, briefly press **F** then **ALPHA** to return to the NUMERIC mode.

### Receiving SelCalls

When your radio receives its SelCall Ident, an alarm will sound to alert you to the call. Initially the alarm will beep urgently at 2 beeps per second, then, if the call is not answered, it will slow to around 1 beep every 3 seconds. It will then continue to beep indefinitely until you cancel it.

In addition to the alarm, the  symbol will appear on the display along with the callers SelCall Ident or ALPHA label to inform you of the caller's identity.



Incoming call showing SelCall Ident



Incoming call showing Alpha label

### RESPONDING TO A SELCALL ALERT

To Cancel the Alarm but leave the incoming Selcall Ident on the display:

- Briefly press **QUIET**. The alarm will stop but the caller's Ident/Name will remain on the display and the channel will remain open to any incoming signals. This feature is useful if you are currently busy but intend to call the person back later.

To Cancel the Alarm and talk on the channel:

- Press the **PTT** and talk in the usual way. The alarm will be cancelled, the display will return to normal and the channel will be open for normal communication.

To Cancel the Alarm and return the call:

- Press and hold **CALL** until the  icon appears. The 'callers' Selcall will be sent back to the caller to let them know you are now available.

### QUIET MODE

The QUIET mode mutes the receiver to prevent incoming signals from being heard in the speaker until your SelCall Ident is received. In this way you can monitor a busy channel for personal calls without being disturbed by unwanted signals. If your SelCall Ident is received, the QUIET mode is cancelled and all incoming signals are heard in the speaker.

## Setting up the QUIET Mode

---

To setup the QUIET mode you must first 'tag' the channels that you want to stay Quiet, then activate the QUIET mode. Once the QUIET mode is activated, tagged channels will remain Quiet to all incoming signals unless your SelCall Ident is received. Channels not tagged will remain open to all signals and will operate normally.

### To Tag Individual Channels for QUIET Operation

---

1. Select the required channel.
2. Press and hold **QUIET** until the radio beeps. 'Q' will appear to the left of the channel number indicating the selected channel is now tagged for Quiet operation.

### To Remove the QUIET Tag from Individual Channels

---

1. Select a channel that has been tagged for Quiet operation. 'Q' will be displayed.
2. Press and hold **QUIET** until the radio beeps. 'Q' will disappear indicating this channel is no longer tagged for Quiet operation.

## Activating the QUIET Mode



---

1. Select a channel that has been tagged for Quiet operation (you cannot activate the Quiet mode unless you have selected a 'tagged' channel). 'Q' will be displayed.
2. Briefly press **QUIET**.  will appear on the display.

Now all channels that were tagged for Quiet operation will be operating in the Quiet mode.

## De-activating the QUIET Mode

---

1. Select any channel that has been tagged for Quiet operation. 'Q' and  will be displayed.
2. Briefly press **QUIET**.  will disappear from the display and all channels that were tagged for Quiet operation will now operate normally again.

## Receiving Signals in the QUIET Mode

---

- If a normal signal is received on a QUIET channel, the channel will appear busy (the  icon will be visible) but no sound will be heard from the speaker.

- If a normal signal is received on an Open channel (one that is not tagged with 'Q') the signal will be heard in the usual way.
- If your SelCall Ident is received on any channel – Open or QUIET – the QUIET mode will be cancelled and the alarm will beep to alert you to the call. In addition, the caller's Ident or ALPHA label will be displayed. All channels will now be open for normal transmission and reception.

If you wish to respond to the caller using SelCall, press and hold **CALL** until the radio beeps. The caller's Ident will be transmitted back to them causing the alarm in their radio to be activated.

**To cancel the alarm on your radio**, briefly press the **PTT**.

**To return your radio to the QUIET mode**, briefly press **QUIET**.  will re-appear on the display.

## Scanning in the QUIET Mode

---

The radio will allow you to scan while the QUIET mode is active. Using this feature you can monitor a group of Quiet channels or a combination of Quiet and Open channels.

### To Scan in the QUIET Mode:

---

1. Pre-select the required OS or GS scan group (briefly press **F** then **OS/GS**).
2. Program your scan channels as described under the Scanning section.
3. From those channels, select the ones you wish to remain Quiet and tag each one for QUIET operation (press and hold **QUIET**).
4. Select a tagged channel and activate the Quiet mode (briefly press **QUIET**).
5. Press **SCAN**. The radio will begin scanning and 'SCAN' and  will be displayed, indicating the radio is scanning in the QUIET mode.

## Receiving Signals While Scanning in the QUIET Mode

---

- If a normal signal is received on an open channel, scanning will pause while the channel is busy and will resume scanning 5 seconds after the channel becomes clear. (If you were scanning in Group Scan mode, the radio may switch

between the open channel and the Priority channel - this is normal).

- If a normal signal is received on a Quiet channel but your SelCall Ident is not detected, the signal will be ignored and scanning will continue.
- If a signal containing your SelCall Ident is received on any channel – Open or Quiet - both scanning and QUIET modes will be cancelled and the receiver will stay on that channel. In addition, the alarm will beep to alert you to the call and the callers Ident or ALPHA label will be displayed. The channel will now be open for normal transmission and reception.

**TIP:** To ensure reliable SelCall detection when scanning in the Quiet mode, it is recommended that you restrict the number of channels in the Scan group to 4 or less.

## GROUP CALLING

The SelCall system includes a Group Call function which allows you to call up to 1000 radios simultaneously. This can be useful in an emergency situation where you may need to transmit a message to a large number of radios in your group.

By default, your radio is factory-set to allow up to 10 radios to be called at once. If your application requires more, you can arrange for your Dealer to re-program this option to allow 100 or 1000 radios to be called. The following description assumes the default Group Call setting of 10 radios.

The Group Call function works by allowing you to enter a special 'group code' into the last digit positions of the SelCall Ident you are sending. The 'group code' appears as an 'A' when displayed in the radio. When this 'group code' is received, it substitutes for all other numbers in that position. As long as the first 4 digits of the SelCall you are sending match those of the radios you are calling, their SelCall alarm will be activated as if their full 5 digit SelCall Idents had been received.

To achieve this, the 10 radios you are calling must be programmed with sequentially numbered SelCall Idents.

e.g. 14530, 14531, 14532, 14533 . . -> , 14539

- Transmitting the SelCall Ident 14531 will only activate the alarm in the radio with the SelCall Ident of 14531.
- Transmitting 1453A will activate the alarms in all radios with Idents 14530 through 14539 (a total of 10 radios).

If the radios in your fleet do not have sequentially numbered SelCall Idents and you want to make use of this function, you will need to re-program the SelCall Idents in your radios.

## Programming and Sending Group Calls

The process for entering a Group call Ident is the same as entering a normal SelCall Ident.

1. Press **CALL**.  is displayed, along with the last sent or received SelCall Ident. If an ALPHA label is displayed you will need to press **F** then **ALPHA** to switch to Numeric mode.
2. Press and hold the **Channel** control (or **LVL** key) until the radio beeps. The right-hand digit of the SelCall Ident will flash.
3. Rotate the **Channel** control (or press **▲** or **▼**) to select 'A' in the flashing digit position. This is the special code that will create the Group Call.
4. Briefly press the **Channel** control (or **LVL** key) again to select the next digit position.
5. Continue entering the other 4 digits as required. The SelCall number is now ready to send.
6. Press and hold **CALL**. A long beep will be heard and the radio will transmit the SelCall Ident.

**NOTE:** Where your radio allows it, programming group calls for 100 radios is identical except that you will need to select 'A' for the last two digits (e.g. 123AA). For 1000 radios you will need to select 'A' for last three digits (e.g. 12AAA).

e.g.

Sending Ident 145AA will call 100 radios with Idents 14500 -> 14599



Sending Ident 14AAA will call 1000 radios with Idents 14000 -> 14999

You can also arrange to send SelCalls to every tenth radio by setting the second digit to A.

e.g.

Sending Ident 145A5 will call radios 14505, 14515, 14525, 14535, 14545 . . -> 14595

### Call Acknowledge in Group Mode

There is no call acknowledge when sending group calls. This is to prevent all the radios in your group from trying to respond to your SelCall transmission at the same time.

### Storing Group Call Idents

Group call Idents can be stored in memory in the same way as a standard SelCall Ident.

### Receiving Group Calls

Receiving a Group call is identical to receiving a normal SelCall except that the alarm sound is a LOW tone beep instead of the normal High tone beep. The caller's Ident or ALPHA label appears on the display in the usual way.

### RECEIVE-ONLY CHANNELS

Your radio supports up to 95 user programmable Receive-only channels with frequencies in the range 403 – 520 MHz. Frequencies can be stored in five separate channel banks labelled A to E, each containing up to 19 channels. These additional 19 channels are located directly above CB channel 80 (81 – 99).

Each Receive-only channel can also be assigned an Alpha label to help identify that channel when it is selected.

### Selecting Channel Banks

Before programming or recalling channels you should select the required Channel Bank. The 5 Channel Banks can be enabled through the menu either as individual banks of 19 channels (RX-A, RX-B, RX-C, RX-D or RX-E) or as a combined group of 95 channels (RXA-E).

The default Channel Bank is RX-A.

To select any Channel Bank

1. Press and hold **MENU** to enter the menu.
2. Press **MENU** repeatedly until 'RX-x is displayed where x is a Channel Bank labelled A, B, C, D or E.
3. Rotate the **Channel** control (or press the **▲** or **▼** keys) to make the desired selection. Select RX-A through RX-E to enable one of the 5 single Channel Banks of 19 channels. Select RXA-E to enable all Channel Banks as a combined group of 95 channels.

When finished briefly press the **PTT** to exit the menu.

### Using Channel Banks

When using individual Channel Banks RX-A to RX-E, each Channel Bank is enabled separately to provide 19 channels of Receive-only frequencies in each bank. Channels are numbered from 81 to 99.

### Separate Channel Banks

	RX-A	RX-B	RX-C	RX-D	RX-E
<b>R</b>	81	81	81	81	81
	82	82	82	82	82
	83	83	83	83	83
	84	84	84	84	84
	85	85	85	85	85
<b>O</b>	86	86	86	86	86
	87	87	87	87	87
	88	88	88	88	88
	89	89	89	89	89
	90	90	90	90	90
<b>C</b>	91	91	91	91	91
	92	92	92	92	92
	93	93	93	93	93
	94	94	94	94	94
	95	95	95	95	95
<b>H</b>	96	96	96	96	96
	97	97	97	97	97
	98	98	98	98	98
	99	99	99	99	99

When using the combined Channel Bank RXA-E, all 5 Channel Banks becomes available in one continuous sequence resulting in a total of 95 channels of Receive-only frequencies. Channels are numbered in a repeating sequence from 81 – 99.

	RX-A	RX-B	RX-C	RX-D	RX-E
R	81	81	81	81	81
X	82	82	82	82	82
O	83	83	83	83	83
N	84	84	84	84	84
L	85	85	85	85	85
Y	86	86	86	86	86
C	87	87	87	87	87
H	88	88	88	88	88
A	89	89	89	89	89
N	90	90	90	90	90
E	91	91	91	91	91
L	92	92	92	92	92
S	93	93	93	93	93
	94	94	94	94	94
	95	95	95	95	95
	96	96	96	96	96
	97	97	97	97	97
	98	98	98	98	98
	99	99	99	99	99

## Channel Editor

Receive-only channels are switched off by default. To enable them you will need to activate the channel editor in your radio which will then allow access to programming frequencies into channels 81 – 99 of your selected Channel Bank. Receive-only channels can be programmed with frequencies in the range 403 – 520 MHz.

### To activate the Channel Editor

1. Switch the radio off.

2. Press and hold the **Channel** control while switching the radio on again.
3. 'RXALL' will be displayed briefly, indicating the RX Channel Editor has been activated.

You can now use the **Channel** control (or press the ▲ or ▼ keys) to select channels 81 – 99 for programming.

### Selecting Frequency Steps

**NOTE:** This menu option is only available when an RX-only channel is selected.

The frequency step is the space between frequencies when the **Channel** control is rotated (or the ▲ or ▼ keys are pressed). The frequency step can be set to either 12.5 kHz or 25.0 kHz. You should select a frequency step that matches the channel allocations in the frequency band you are programming. If in doubt, selecting 12.5 kHz will ensure you do not miss any useful channels. When selecting 12.5 kHz or 25.0 kHz steps the appropriate wideband or narrowband filter will be selected automatically to ensure optimum performance.

1. Select a Receive-only channel.
2. Press and hold **MENU** to select the menu.
3. Press **MENU** repeatedly until the frequency step is displayed.

25.0K      12.5K

25kHz Steps

12.5 kHz Steps

4. Rotate the **Channel** control (or press the ▲ or ▼ keys) to change the frequency step
5. Press the **PTT** to exit the menu.

### Displaying Frequencies

When selecting frequencies, your radio may change the frequency in 12.5 kHz or 25 kHz steps, however the display will only show the frequency to the nearest 10 kHz. See the table on page 27.

e.g. 468.4250 MHz will display as:

Display	Frequency
46840	468.4000
46841	468.4125
46842	468.4250
46843	468.4375
46845	468.4500
46846	468.4625
46847	468.4750
46848	468.4875
46850	468.5000

## Programming Receive-only Frequencies

While in the channel editor:

1. Rotate the **Channel** control (or press the ▲ or ▼ keys) to select a suitable channel (81-99).
2. Press and hold **MENU** until the radio beeps. '–OFF–' will flash under the channel number. You now have 6 seconds to begin programming otherwise the menu will time-out.
3. Rotate the **Channel** control to the right (or press the ▲ key) to begin selecting the desired frequency starting at 403 MHz. Continue rotating the **Channel** control to the right (or pressing the ▲ key) to increase the frequency in 12.5/25 kHz steps (the display will show the frequency to the nearest 10 kHz). Rotate the **Channel** control to the left (or press the ▼ key) to decrease the frequency.
4. To change the frequency in 1 MHz steps, briefly press the **Channel** control. The 1 MHz digit will flash. Now rotate the **Channel** control (or press the ▲ or ▼ keys) to adjust the frequency in 1 MHz steps. As you approach the desired frequency, briefly press the **Channel** control again to return the original 12.5/25 kHz steps for finer adjustment.
5. When the desired frequency is displayed, press and hold the **Channel** control to store it. The frequency will flash then the radio will beep. The radio will then exit the menu and return to normal operation.

e.g. 458.325 MHz stored under CH 90



6. Repeat steps 1 – 5 to program other channels.

**NOTE:** The frequency tuning is live which means the radio is actually listening to the frequencies you are selecting. You can use this feature to locate and store active frequencies while you are tuning.

If you need to program more than 19 channels, you will need to select another Channel Bank.

## To Close the Channel Editor

Once you have finished programming your frequencies, switch the radio Off then On again. Normal operation will be restored and the Receive-only channels you have programmed will be visible above channel 80. Remember, if you have programmed some of your channels into different Channel Banks, you will need to select the appropriate Channel Bank (from within the menu) to access them.

## Displaying Alpha Names on your Receive-only Channels

By default your radio displays the received signal strength to the left of the channel number on all channels. However on Receive-only channels you can also configure the display to show an Alpha name or the channel frequency. This option is only available when a receive-only channel is selected.

1. Select a receive-only channel.
2. Press and hold **MENU** until the radio beeps.
3. Briefly press **MENU** repeatedly to advance to the S-Meter option. ('S-MET', 'S-LIN' or 'BATT' will be displayed. 'S-MET' is the default).
4. Rotate the **Channel** control (or press the ▲ or ▼ keys) until '**ALPHA**' is displayed.
5. Press the **PTT** to exit the menu.

The channel will now display the channel frequency or an Alpha name (depending on whether your radio is in Alpha mode).

## To Switch Between Alpha and Frequency Display Modes

1. Select a receive-only channel.
2. Briefly press the **F** key followed by the **ALPHA** key to switch between Alpha and Frequency (numeric) modes.

**NOTE:** If you have not previously set an Alpha name, a default Alpha name comprising the Channel Bank and the channel number will be displayed. e.g. RXA99.

## To Edit the Alpha Label

1. Press and hold **MENU** until the radio beeps. The left hand character will be flashing.
2. Rotate the **Channel** control (or press the **▲** or **▼** keys) to change the flashing character.
3. Press the **Channel** control (or the **LVL** key) to move to the next character position.
4. Repeat steps 2 and 3 to edit each character.
5. When finished, press and hold the **Channel** control (or the **LVL** key) to store the new label. The display will flash then the radio will beep.



RX-Only Channel Frequency (458.325 MHz)



RX-Only Alpha Label

## To Edit the Frequency of a Receive-only Channel

**NOTE:** You do not need to enable the channel editor to edit a current Receive-only channel.

1. Rotate the **Channel** control (or press the **▲** or **▼** keys) to select the desired Receive-only channel.
2. If the channel's ALPHA label is displayed briefly press the **F** key followed by the **ALPHA** key to switch to Frequency (numeric) mode.
3. Press and hold **MENU** until the radio beeps. The right hand digit will be flashing.
4. Rotate the **Channel** control (or press the **▲** or **▼** keys) to select a new frequency. To switch between 12.5/25 kHz and 1 MHz frequency steps briefly press the **Channel** control (or the **LVL** key).
5. When the desired frequency is selected, press and hold the **Channel** control (or the **LVL** key) to store the new setting.

## To Delete a Receive-only Channel

**NOTE:** You do not need to enable the channel editor to delete Receive-only channels.

1. Rotate the **Channel** control (or press the **▲** or **▼** keys) to select the desired Receive-only channel.
2. If the channel's ALPHA label is displayed briefly press the **F** key followed by the **ALPHA** key to switch to Frequency (numeric) mode.
3. Press and hold **MENU** until the radio beeps. The right hand digit will be flashing.
4. Briefly press the **Channel** control (or the **LVL** key) to select the 1 MHz digit (this will allow faster frequency stepping) then rotate the **Channel** control to the left (or press and hold the **▼** key) until '-OFF-' is displayed.
5. To store the setting, press and hold the **Channel** control (or the **LVL** key).

The deleted channel will no longer be visible in normal operating mode.

### Scanning Receive-only Channels

Receive-only channels can be programmed into your Open or Group scan groups in the same way as your normal CB channels. Receive-only channels cannot be programmed into your Network scan group.

To add receive-only channel to your scan group, simply select the required scan group (Open or Group), select the desired receive-only channel then press and hold the **SCAN** key until the radio beeps.  will be displayed on that channel. For more details on scanning, see the section on 'Scanning' in this manual.

### CONFIGURATION MENU

The configuration menu controls preset functions in the radio.

To access the menu, press and hold **MENU** until a beep is heard. Selected menu options are displayed to the left of the channel display. Briefly press **MENU** to step through the available menu options. Rotate the **Channel** control (or press the **▲** or **▼** keys) to change the selected menu option.

After viewing or making changes, briefly press the **PTT** to exit the menu (or simply wait a few seconds for the menu function to time-out).

The following settings are available.

Menu Option	UHF CB Channel	RX-Only Channel
RX-Only Frequency /Alpha Label:	NA	Frequency, Alpha Label
CTCSS/DCS:	CTCOF, CTC01-CTC50, DT001-DT104	
Network Scan	NS-0F, NS-01 to NS-50, NS001 to NS104	
Voice Scrambler:	ENCOF, ENCON	
Silent Squelch Tail	SSTOF, SSTON	
Beep Tone Level:	BEEP 0 to BEEP 9	
Filter Bandwidth:	WBFLT , NBFLT	12.5/25 kHz
Dynamic Volume Control:	DVCOF, DVCON	
Display Mode Options:	S-MET, S-LIN, BATT	S-MET, S-LIN, BATT, ALPHA
Busy Lockout:	BLKOF, BLKON	
RX Only Channel Banks:	RX-A, RX-B, RX-C, RX-D, RX-E, RXA-E	

## INSTALLATION

### GENERAL

Your radio is supplied with a slim, slide on mounting cradle. As the radio contains a built-in speaker, the cradle can be screwed or bolted to any convenient location in your vehicle's cabin (under or above the dash or on the centre console) using the mounting slots provided in the cradle.

In the case of the remote mount TX3520S, the remote head can be installed in a convenient location inside the cabin allowing the main unit to be hidden away under the seat, in the glove box or even in the boot if required. In this case an extension speaker will also be required.

When planning your installation, avoid locations that are close to heaters or air conditioners.

### TX3510S AND TX3540S INSTALLATION

For maximum sound projection from the internal speaker, we recommend the cradle be mounted above the radio to minimise any obstruction of the speaker. Alternatively, if it is necessary to mount the unit in a less audible location, an extension speaker can be used. The extension speaker plugs into the extension speaker socket on the radio's rear panel.

### Console Mounting

A flush mounting DIN adapter MBD001 is available as an optional accessory. The adapter includes mounting brackets and a specially designed front panel escutcheon to suit most vehicle installations. See your nearest GME retailer for details.

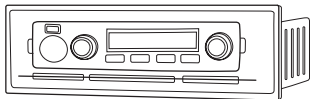

Din Adapter MBD001

### Installing the Cradle

Screw the mounting cradle to a firm surface then slide the radio's main unit into the cradle from the front until it clicks into place. Finally, connect the power lead, antenna cable and extension speaker (if required) to the sockets on the radio's rear panel.

### Mounting the Cradle

#### Option 1

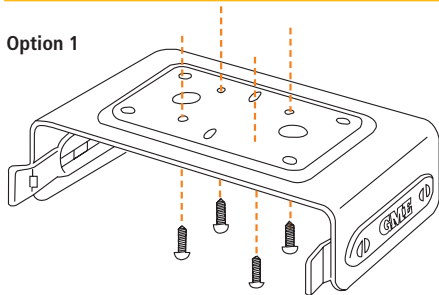

#### Option 2

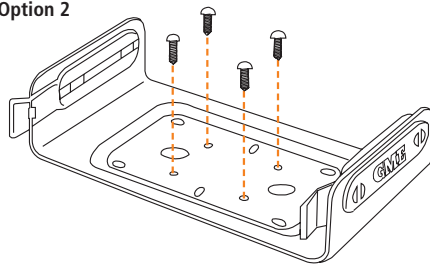

### Fitting the Radio

Slide radio fully into cradle until it clicks into place.

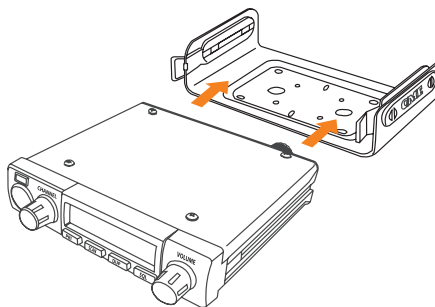

## Removing the Radio

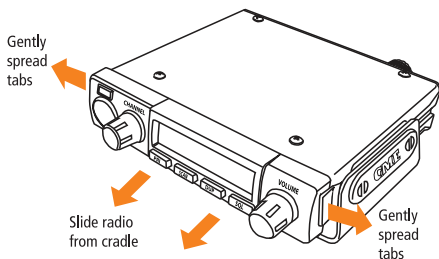

## TX3520S INSTALLATION

The TX3520S remote head can be installed inside the cabin with the main unit hidden away in the glove box, under the seat or in the boot. Install the remote head bracket into a convenient location near your driving position using screws or double sided tape. Loosen the gimbals controls and slide the remote head into the slots in the bracket. Adjust the remote head for the desired angle then tighten the controls.

The mounting of the main unit is identical to that of the TX3510S and TX3540S models. If the main unit is installed in a remote location, you will also need to install an extension speaker inside the cabin. The extension speaker plugs into the extension speaker socket on the rear panel of the main unit.

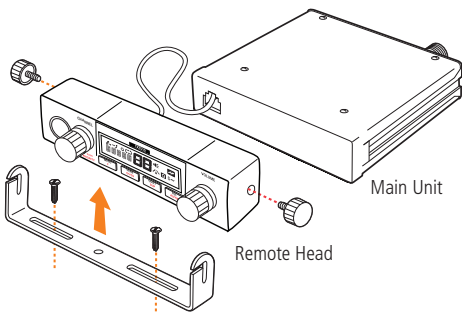

The remote head cable uses an 8 pin telephone style connector. Plug the cable from the remote head into the socket in the FRONT of the MAIN unit. Plug the MICROPHONE (6 pin plug) into the front of the REMOTE HEAD unit. (Alternatively the microphone can be plugged into the rear microphone socket on the main unit.

**NOTE:** The remote head socket (8 pin) is different to the microphone socket (6 pin). Do not attempt to plug the microphone into the front of the main unit as it will not fit

## MICROPHONE

The TX3510S and TX3520S uses a standard microphone fitted with a 6 pin telephone style plug. The standard microphone will fit the 6 pin socket in the front of the TX3510S and TX3520S radio panels. Alternately the standard microphone can be plugged into the microphone socket on radio's rear panel.. If connecting the microphone to the rear socket, an optional extension cable LEM6P is available if required to bring the microphone connection to a more accessible location.

The TX3540S uses a controller microphone which has an 8 pin telephone style plug. This microphone can only be plugged into the 8 pin socket on the front of the TX3540S main unit. The controller microphone cannot be plugged into the rear microphone socket.

## Fitting the Standard Microphone

### Front

1. The front microphone cover is a press fit. To remove, simply insert the end of a paper clip or similar into the small slot in the edge of the cover and lift the cover away from the panel. Retain the cover in case you require it later on.
2. Position the microphone plug so the plastic tab faces downwards, and press the plug into the socket until it 'clicks'.

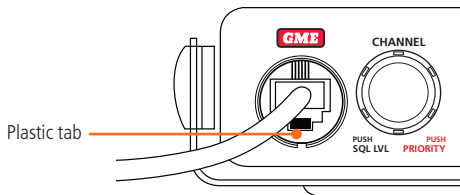

3. Gently press the rubber strain relief into the hole surrounding the socket so that the slot around the strain relief fits neatly inside the lip of the hole.

## Rear

1. The rear microphone cover hinges from the top. Simply lift the cover from the bottom. The cover will remain connected to the chassis.
2. Position the microphone plug so the plastic tab faces downwards, and press the plug into the socket until it 'clicks'.

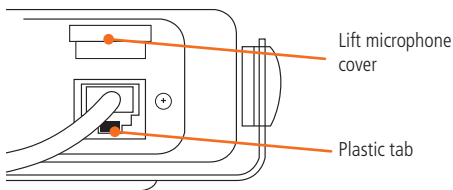

## Removing the Microphone

1. For front panel connections, first squeeze the rubber strain relief near the front panel to disengage the slot, and slide the strain relief back along the microphone cord.
2. For both connections, squeeze the plastic tab on the microphone plug towards the plug to unlock it while gently pulling the plug outwards. If the plug does not come out easily, the tab has not released correctly and should be squeezed again.

## Fitting the Controller Microphone

Plug the 8 pin plug into the socket on the front of the main unit or alternatively you can use the adapter and extension cable supplied with the radio. If the main unit is not easily accessible this adapter will allow you to bring the microphone socket to a more convenient position

Attach the microphone clip to a convenient location near your driving position using screws. Slide the bollard on the back of the microphone into the clip to secure it.



## DC POWER CONNECTION

The radio is designed for 13.8 volt DC, negative earth installations only (i.e. where the negative terminal of the battery is connected to the chassis or frame of the vehicle). There are two recommended methods of installation.

### Radio remains ON when the ignition switch is OFF

Connect the radio's negative (black) lead to the vehicle's chassis, or if preferred, directly to the battery's negative terminal. The radio's positive (red) lead should be connected via the 2 amp fuse to the battery's positive terminal.

Alternatively, the positive lead could be connected into the fuse box at a point that has +13.8 volts continuously available (on the battery side of the ignition switch) via the 2 amp fuse.

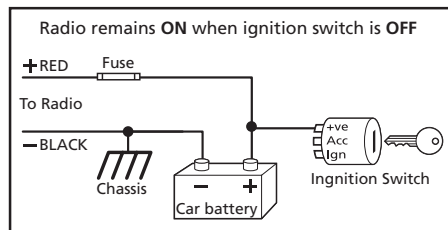

### Radio turns ON and OFF with the ignition switch



Connect the radio's negative (black) lead to the vehicle's chassis, or if preferred, directly to the battery's negative terminal. The radio's positive (red) lead should connect to an accessory point in the vehicle's fuse box via the 2 amp fuse. This point should supply +13.8 volts only when the ignition switch is turned ON or in the ACCESSORY position via the 2 amp fuse.

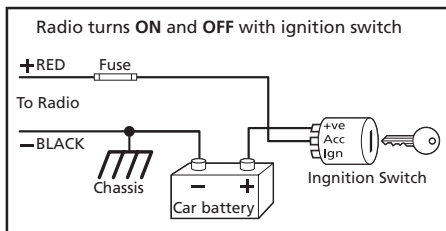

### High Voltage Detection

The radio has a built-in, high voltage detection system to warn you if an overvoltage situation occurs. If the power supply voltage exceeds 18 volts DC, the channel display will flash 'hi dc' for 5 seconds when the unit is first turned on, or at the time the voltage exceeds 18 volts. In addition, when transmitting, the TX indicator will flash and the transmitter will select low output power.

If the overvoltage warning appears you should switch your radio OFF and disconnect it from the power source, before locating the cause of the trouble.

Once the 'High Voltage' warning has been triggered, and you have fixed the source of the problem, you will need to switch the radio OFF then ON again to reset it.

**NOTE:** The power source should never exceed 30 volts.

### ANTENNA CONNECTION

It is essential to select a good quality, high efficiency, 477 MHz antenna. A poor quality antenna or one not designed for the specific frequency band you are using will give very poor performance.

GME have a wide range of suitable 477 MHz UHF CB antennas to suit most installations and applications. We recommend contacting your local GME retailer for advice. Connect to the antenna cable to the rear antenna socket using a PL259 coaxial connector.

### NOISE SUPPRESSION

The inherent design of FM transceivers results in a high level of resistance to ignition and electrical interference. However in some installations it may be necessary to take additional steps to help reduce or eliminate noise interference. During installation, try to route the DC battery leads, the antenna lead or any accessory wires away from the engine compartment, ignition or alternator wiring. If the noise continues, it may be necessary to fit a suppression kit in which case we recommend you consult an auto electrician for advice specific to your installation.

Higher frequency electrical interference caused by electric motors can be suppressed directly at the motor terminals.

**TX3510S Main Wiring**

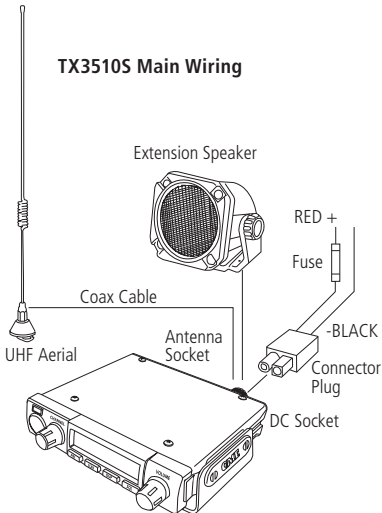

**TX3520S Main Wiring**

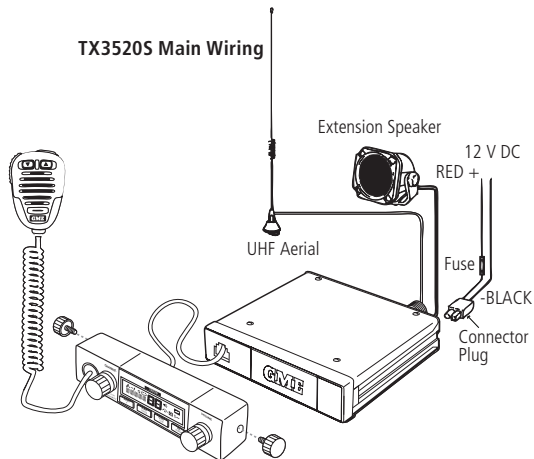

**TX3540S Main Wiring**

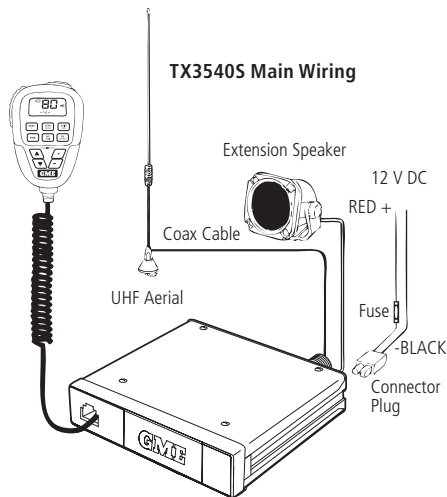

**CTCSS TONE FREQUENCY CHART**

No.	Frequency	No.	Frequency	No.	Frequency	No.	Frequency
1	67.0	14	107.2	27	167.9	40	159.8
2	71.9	15	110.9	28	173.8	41	165.5
3	74.4	16	114.8	29	179.9	42	171.3
4	77.0	17	118.8	30	186.2	43	177.3
5	79.7	18	123.0	31	192.8	44	183.5
6	82.5	19	127.3	32	203.5	45	189.9
7	85.4	20	131.8	33	210.7	46	196.6
8	88.5	21	136.5	34	218.1	47	199.5
9	91.5	22	141.3	35	225.7	48	206.5
10	94.8	23	146.2	36	233.6	49	229.1
11	97.4	24	151.4	37	241.8	50	254.1
12	100.0	25	156.7	38	250.3	–	–
13	103.5	26	162.2	39	69.4	–	–

## DSC TONE CHART

DCS	CODE	DCS	CODE	DCS	CODE	DCS	CODE	DCS	CODE	DCS	CODE
1	023	19	116	37	225	55	325	73	452	91	627
2	025	20	122	38	226	56	331	74	454	92	631
3	026	21	125	39	243	57	332	75	455	93	632
4	031	22	131	40	244	58	343	76	462	94	654
5	032	23	132	41	245	59	346	77	464	95	662
6	036	24	134	42	246	60	351	78	465	96	664
7	043	25	143	43	251	61	356	79	466	97	703
8	047	26	145	44	252	62	364	80	503	98	712
9	051	27	152	45	255	63	365	81	506	99	723
10	053	28	155	46	261	64	371	82	516	100	731
11	054	29	156	47	263	65	411	83	523	101	732
12	065	30	162	48	265	66	412	84	526	102	734
13	071	31	165	49	266	67	413	85	532	103	743
14	072	32	172	50	271	68	423	86	546	104	754
15	073	33	174	51	274	69	431	87	565	-	-
16	074	34	205	52	306	70	432	88	606		
17	114	35	212	53	311	71	445	89	612	-	-
18	115	36	223	54	315	72	446	90	624	-	-

## UHF CB OPERATING FREQUENCIES

CH	Frequency (MHz)	CH	Frequency (MHz)	CH	Frequency (MHz)	CH	Frequency (MHz)
1	476.425	21	476.925	41	476.4375	61	476.9375
2	476.450	22	476.950	42	476.4625	62	476.9625
3	476.475	23	476.975	43	476.4875	63	476.9875
4	476.500	24	477.000	44	476.5125	64	477.0125
5	476.525	25	477.025	45	476.5375	65	477.0375
6	476.550	26	477.050	46	476.5625	66	477.0625
7	476.575	27	477.075	47	476.5875	67	477.0875
8	476.600	28	477.100	48	476.6125	68	477.1125
9	476.625	29	477.125	49	476.6375	69	477.1375
10	476.650	30	477.150	50	476.6625	70	477.1625
11	476.675	31	477.175	51	476.6875	71	477.1875
12	476.700	32	477.200	52	476.7125	72	477.2125
13	476.725	33	477.225	53	476.7375	73	477.2375
14	476.750	34	477.250	54	476.7625	74	477.2625
15	476.775	35	477.275	55	476.7875	75	477.2875
16	476.800	36	477.300	56	476.8125	76	477.3125
17	476.825	37	477.325	57	476.8375	77	477.3375
18	476.850	38	477.350	58	476.8625	78	477.3625
19	476.875	39	477.375	59	476.8875	79	477.3875
20	476.900	40	477.400	60	476.9125	80	477.4125

	Emergency use only
	Telemetry / SelCall use only. Voice transmission is inhibited as required by AS/NZS 4365.2011
	Guard band channel. Transmission is inhibited as required by AS/NZ 4365.2011
	Repeater input channels (Duplex)

	Repeater output channels (Duplex)
	11 Officially designated call channel
	40 Road channel
	18 Caravan and motor-home
	10 4WD / Off-road

## SPECIFICATIONS

### ELECTRICAL

#### General

Compliant Specification: Meets AS/NZS 4365 for radio communications equipment in the UHF citizen and personal radio service.

Frequency Range TX: 476.425-477.4125 MHz

Number of Channels: 80

Channel Spacing: 12.5 kHz

Operation Mode: Simplex or half Duplex with repeater talk around.

Scanning Speed: 25 ms per channel (40 channels per second).

Antenna Impedance: 50 Ohms nominal

Nominal Battery Voltage: 12 volts DC

Operating Voltage Range: 10-16 volts DC

Battery Polarity: Negative Earth

Standard Test Voltage: 13.8 volts DC

Over Voltage Protection: 30 volts DC maximum. At 18 volts DC the channel display flashes 'Hi DC' for 5 seconds on receive. The RF power is reduced and TX flashes on transmit.

Reverse Voltage Protection: Diode Crowbar

Overcurrent Protection: In-line 2 amp fuse

Operating Temperature: -10°C to 60°C

#### Transmitter

RF Output: 5 watts

Spurious Emission: < -70 dBc

Frequency Error:  $\pm 1.5$  kHz

Modulation: FM

Maximum Deviation:  $\pm 2.5$  kHz at +20 dB AF limiting.

Transmit Frequency

Response: +6 dB per octave  
300 Hz to 3 kHz + 1-3 dB.

Demodulated Audio

Signal to Noise: >45 dB unweighted

Current Consumption: 1.7 amps with 50 Ohms termination.

#### Receiver

Intermediate Frequencies: 38.85 MHz, 450 kHz

Sensitivity: -122 dBm for 12 dB SINAD unweighted

Selectivity: -6 dB at +3.5 kHz  
-60 dB at  $\pm 12.5$  kHz

Intermodulation

Immunity: -72 dB

Blocking Immunity: -98 dB

Spurious Response

Immunity: 70 dB

Audio Output Power: 3 watts average into 4 Ohms

Audio Signal to Noise: >45 dB unweighted

Receive Frequency

Response: -6 dB/Octave de-emphasis  
300 Hz to 3 kHz + 1-3 dB.

Current Consumption: <175 mA muted  
750 mA full volume.

Conducted Spurious

Emission: <70 dBm

### MECHANICAL SPECIFICATIONS & CONNECTIONS

Dimensions: 29 (H) x 128 (L) x 117 (D) mm

Weight: 450 grams

12 Volt Power Supply: Two core cable with bulkhead connector in rear panel.

Antenna: S0239 panel socket

External Speaker: 3.5 mm mono jack

Microphone Port: 6 way telephone style with rubber strain relief.

Specifications are subject to change without notice or obligation

# STANDARD COMMUNICATIONS CONTRACT WARRANTY AGAINST DEFECTS

This warranty against defects is given by Standard Communications Pty Ltd ACN 000 346 814 (We, us, our or GME). Our contact details are set out in clause 2.7.

## 1. Consumer guarantees

- 1.1 Our goods come with guarantees that cannot be excluded under the Australian Consumer Law. You are entitled to a replacement or refund for a major failure and for compensation for any other reasonably foreseeable loss or damage. You are also entitled to have the goods repaired or replaced if the goods fail to be of acceptable quality and the failure does not amount to a major failure.
- 1.2 To the extent we are able, we exclude all other conditions, warranties and obligations which would otherwise be implied.

## 2. Warranty against defects

- 2.1 This warranty is in addition to and does not limit, exclude or restrict your rights under the Competition and Consumer Act 2010 (Australia) or any other mandatory protection laws that may apply.
- 2.2 We warrant our goods to be free from defects in materials and workmanship for the warranty period (see warranty table) from the date of original sale (or another period we agree to in writing). Subject to our obligations under clause 1.2, we will at our option, either repair or replace goods which we are satisfied are defective. We warrant any replacement parts for the remainder of the period of warranty for the goods into which they are incorporated.
- 2.3 To the extent permitted by law, our sole liability for breach of a condition, warranty or other obligation implied by law is limited
  - (a) in the case of goods we supply, to any one of the following as we decide –
    - (i) the replacement of the goods or the supply of equivalent goods;
    - (ii) the repair of the goods;
    - (iii) the cost of repairing the goods or of acquiring equivalent goods;
  - (b) in the case of services we supply, to any one of the following as we decide –
    - (i) the supplying of the services again;
    - (ii) the cost of having the services supplied again.
- 2.4 For repairs outside the warranty period, we warrant our repairs to be free from defects in materials and workmanship for three months from the date of the original repair. We agree to

re-repair or replace (at our option) any materials or workmanship which we are satisfied are defective.

- 2.5 We warrant that we will perform services with reasonable care and skill and agree to investigate any complaint regarding our services made in good faith. If we are satisfied that the complaint is justified, and as our sole liability to you under this warranty (to the extent permitted at law), we agree to supply those services again at no extra charge to you.
- 2.6 To make a warranty claim you must before the end of the applicable warranty period (see warranty table), at your own cost, return the goods you allege are defective, provide written details of the defect, and give us an original or copy of the sales invoice or some other evidence showing details of the transaction.
- 2.7 Send your claim to: Standard Communications Pty Ltd.  
PO Box 96 Winston Hills, NSW 2153, Australia.  
Tel: (02) 8867 6000 Fax: (02) 8867 6199  
Email: servadmin@gme.net.au
- 2.8 If we determine that your goods are defective, we will pay for the cost of returning the repaired or replaced goods to you, and reimburse you for your reasonable expenses of sending your warranty claim to us.

## 3. What this warranty does not cover

- 3.1 This warranty will not apply in relation to:
  - (a) goods modified or altered in any way;
  - (b) defects and damage caused by use with non Standard Communications products;
  - (c) repairs performed other than by our authorised representative;
  - (d) defects or damage resulting from misuse, accident, impact or neglect;
  - (e) goods improperly installed or used in a manner contrary to the relevant instruction manual; or
  - (f) goods where the serial number has been removed or made illegal.

## 4. Warranty period

- 4.1 We provide the following warranty on GME and Kingray products. No repair or replacement during the warranty period will renew or extend the warranty period past the period from original date of purchase.

PRODUCT TYPE	WARRANTY PERIOD
All fixed mount 'S' model UHF CB radios	5 years



ISO 9001: 2008  
AU97/0906  
List of certified  
characteristics available  
at [www.sgs.com](http://www.sgs.com)

For more information call or visit us:

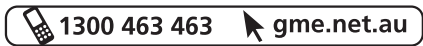

A division of Standard Communications Pty Ltd.

**Head Office:** PO Box 96, Winston Hills, NSW 2153, Australia

New Zealand: PO Box 58, 446 Botany, Auckland, 2163, NZ T: (09) 274 0955

All other international enquiries email: [export@gme.net.au](mailto:export@gme.net.au)

---

Part Number: 310594 Drawing Number: 46884-3