



Operating Instruction for Autoranging Digital Multimeter



Please read this manual before switching the unit on.
Important safety information inside.

Content	Page
1.Safety.....	4
1-1.Safety Instructions.....	4
1-2.Safety Symbols.....	4
1-3.Input Limits.....	5
2.Description.....	6
2-1.Meter Description.....	6
2-2.Symbols Used on LCD Display.....	7
3.Button Function.....	7
4.Operation.....	8
4-1.DC Voltage Measurement.....	8
4-2.AC Voltage Measurement.....	9
4-3.DC Current Measurement.....	10
4-4.AC Current Measurement.....	11
4-5.Resistance Measurement.....	12
4-6.Continuity Check.....	13
4-7.Diode Test.....	14
5.Replacing the Battery.....	15
6.Replacing the Fuses.....	15
7.Specifications.....	16
7-1.Technical Specifications.....	16
7-2.General Specifications.....	18

1. Safety

1-1. Safety Instructions

The following safety information must be observed to ensure maximum personal safety during the operation at this meter:

- Do not use the meter if the meter or test leads look damaged, or if you suspect that the meter is not operating properly.
- Never ground yourself when taking electrical measurements.
- Do not touch exposed metal pipes, outlets, fixtures, etc., which might be at ground potential.
- Keep your body isolated from ground by using dry clothing, rubber shoes, rubber mats, or any approved insulating material.
- Turn off power to the circuit under test before cutting, unsoldering, or breaking the circuit, small amounts of current can be dangerous.
- Use caution when working above 60V dc or 30V ac rms, such voltages pose a shock hazard.
- When using the probes, keep your fingers behind the finger guards on the probes.
- Measuring voltage which exceeds the limits of the multimeter may damage the meter and expose the operator to a shock hazard, always recognize the meter voltage limits as stated on the front of the meter.
- Never apply voltage or current to the meter that exceeds the specified maximum.

1-2. Safety Symbols



This symbol adjacent to another symbol, terminal or operating device indicates that the operator must refer to an explanation in the Operating Instructions to avoid personal injury or damage to the meter.

WARNING This **WARNING** symbol indicates a potentially hazardous situation, which if not avoided, could result in death or serious injury.

CAUTION This **CAUTION** symbol indicates a potentially hazardous situation, which if not avoided, may result damage to the product.

 **MAX** This symbol advises the user that the terminal (s) so marked must not be connected to a circuit point at which the voltage with respect to earth ground exceeds (in this case) 600 VAC or VDC.

-  This symbol adjacent to one or more terminals identifies them as being associated with ranges that may, in normal use, be subjected to particularly hazardous voltages. For maximum safety, the meter and its test leads should not be handled when these terminals are energized.

1-3. Input Limits

Function	Maximum Input
VDC or VAC	600V DC/AC
mA DC/AC	200mA DC/AC
Resistance, Diode Test, Continuity	250V DC/AC

2. Description

2-1. Meter Description

- 1-NCV Indicate Lamp
- 2-2000 Count Liquid Crystal Display
- 3-MAX Hold Button
- 4-MODE Button
- 5-Function Switch
- 6-COM Input Jack
- 7-Positive Input Jack
- 8-Battery Cover

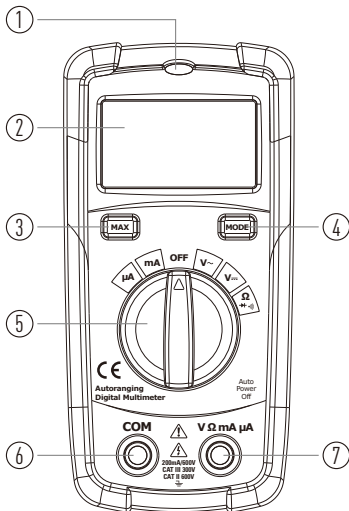
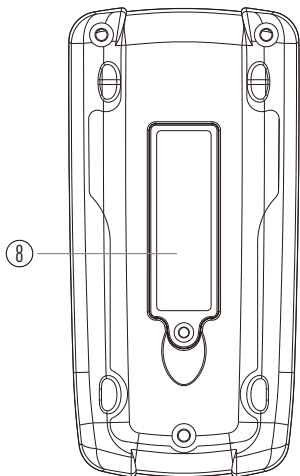

2-2.Symbols Used on LCD Display

1-Autoranging	6-Units of Measure List
2-Diode Test	7-Measurement Reading
3-Continuity	8-Minus Sign
4-Maximum	9-Alternating Current
5-Battery Status	10-Direct Current

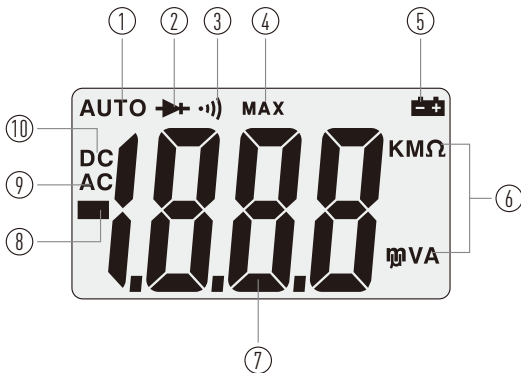

3.Button Function

3-1.MODE Button

To select Diode/Continuity or DC/AC current.

3-2.MAX Hold Button

- The max. Hold position is used to measure the maximum value.
- The maximum measured value is up dated continuously.
- To take a Max Hold measurement, press and release the button. To take another Max Hold reading, press and release the button again.

4. Operation

WARNING: Risk of electrocution. High-voltage circuits, both AC and DC, are very dangerous and should be measured with great care.

- Always turn the function switch to the OFF position when the meter is not in use, this meter has Auto OFF that automatically shuts the meter OFF if 15 minutes elapse between uses.
- If "OL" appears in the display during a measurement, the value exceeds the range you have selected, change to a higher range.

Note: On some low AC and DC voltage ranges, with the test leads not connected to a device, the display may show a random, changing reading, this is normal and is caused by the high-input sensitivity, the reading will stabilize and give a proper measurement when connected to a circuit.

4-1. DC Voltage Measurement

CAUTION: Do not measure DC voltages if a motor on the circuit is being switched ON or OFF. Large voltage surges may occur that can damage the meter.

1. Set the function switch to the **VDC** Position ("mV" will appear in the display).
2. Insert the black test lead banana into the **COM** Input Jack; Insert the red test lead banana into the **Positive** Input Jack.
3. Touch the test probe tips to the circuit under test, be sure to observe the correct polarity (Red lead to positive, Black lead to negative).
4. Read the voltage in the display.

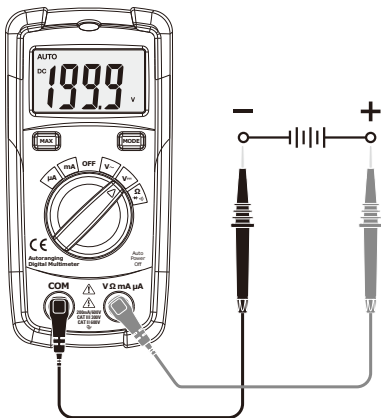

4-2.AC Voltage Measurement

WARNING: Risk of Electrocution. The probe tips may not be long enough to contact the live parts inside some 240V outlets for appliances because the contacts are recessed deep in the outlets. As a result, the reading may show 0 volts when the outlet actually has voltage on it. Make sure the probe tips are touching the metal contacts inside the outlet before assuming that no voltage is present.

CAUTION: Do not measure AC voltages if a motor on the circuit is being switched ON or OFF. Large voltage surges may occur that can damage the meter.

1. Set the function switch to the **VAC** Position.
2. Insert the black test lead banana into the **COM** Input Jack; Insert the red test lead banana into the **Positive** Input Jack.
3. Touch the test probe tips to the circuit under test, be sure to observe the correct polarity (Red lead to positive, Black lead to negative).
4. Read the voltage in the display.

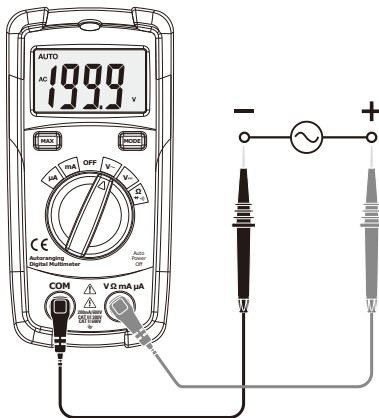

4-3.DC Current Measurement

WARNING: Risk of Electrocution. The probe tips may not be long enough to contact the live parts inside some 240V outlets for appliances because the contacts are recessed deep in the outlets. As a result, the reading may show 0 volts when the outlet actually has voltage on it. Make sure the probe tips are touching the metal contacts inside the outlet before assuming that no voltage is present.

CAUTION: Do not measure AC voltages if a motor on the circuit is being switched ON or OFF. Large voltage surges may occur that can damage the meter.

1. For current measurements up to **2000 μ A DC**, set the function switch to the **μ A** Position.
2. For current measurements up to **200mA DC**, set the function switch to the **mA** Position.
3. Insert the black test lead banana into the **COM** Input Jack; Insert the red test lead banana into the **Positive** Input Jack.
4. Press the **MODE** Button until "**DC**" appears in the display.
5. Remove power from the circuit under test, then open up the circuit at the point where you wish to measure current.
6. Touch the black test probe tip to the negative side of the circuit; Touch the red test probe tip to the positive side of the circuit.
7. Apply power to the circuit.
8. Read the current in the display

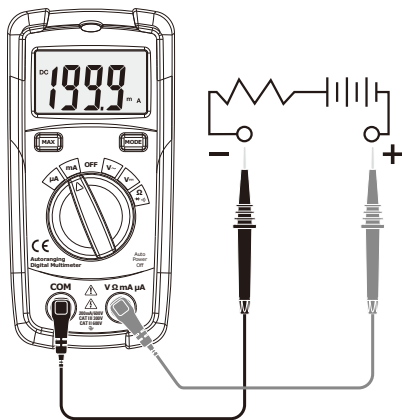

4-4.AC Current Measurement

WARNING: To avoid electric shock, do not measure AC current on any circuit whose voltage exceeds 250V AC.

1. For current measurements up to **2000 μ A AC**, set the function switch to the **μ A** Position.
2. For current measurements up to **200mA AC**, set the function switch to the **mA** Position.
3. Insert the black test lead banana into the **COM** Input Jack; Insert the red test lead banana into the **Positive** Input Jack.
4. Press the **MODE** Button until "**AC**" appears in the display.
5. Remove power from the circuit under test, then open up the circuit at the point where you wish to measure current.
6. Touch the black test probe tip to the negative side of the circuit; Touch the red test probe tip to the positive side of the circuit.
7. Apply power to the circuit.
8. Read the current in the display

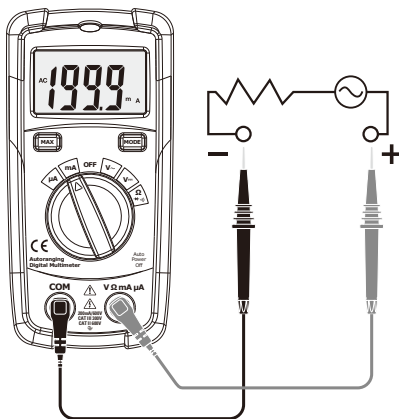

4-5. Resistance Measurement

WARNING: To avoid electric shock, disconnect power to the unit under test and discharge all capacitors before taking any resistance.

1. Set the function switch to the Ω \rightarrow \rightarrow Position.
2. Insert the black test lead banana into the **COM** Input Jack; Insert the red test lead banana into the **Positive** Input Jack.
3. Touch the test probe tips across the circuit or part under test. It is best to disconnect one side of the part under test so the rest of the circuit will not interfere with the resistance reading.
4. Read the resistance in the display.

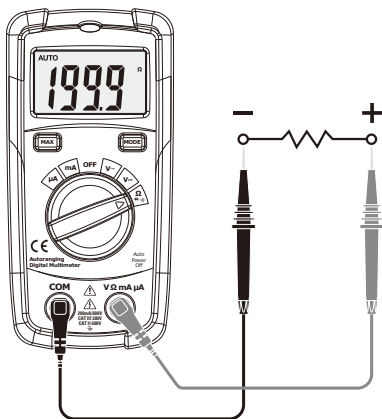

4-6. Continuity Check

WARNING: To avoid electric shock, never measure continuity on circuits or wires that have voltage on them.

1. Set the function switch to the Ω \rightarrow diode Position.
2. Insert the black test lead banana into the **COM** Input Jack; Insert the red test lead banana into the **Positive** Input Jack.
3. Press the **MODE** Button until the “ diode ” symbol appears in the display.
4. Touch the test probe tips to the circuit or wire you wish to check.
5. If the resistance is less than approximately 100Ω , the audible signal will sound, the display will also show the actual resistance.

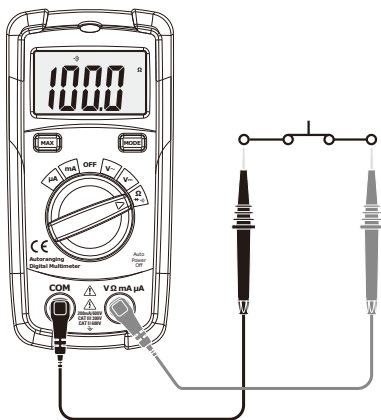

4-7. Diode Test

WARNING: To avoid electric shock, do not test any diode that has voltage on it.

1. Set the function switch to the $\Omega \rightarrow \rightarrow$ Position.
2. Insert the black test lead banana into the **COM** Input Jack; Insert the red test lead banana into the **Positive** Input Jack.
3. Press the **MODE** Button until the " \rightarrow " symbol appears in the display.
4. Touch the test probe tips to the diode or semiconductor junction you wish to test, note the meter reading.
5. Reverse the probe polarity by switching probe position, note this reading.
6. The diode or junction can be evaluated as follows:
 - If one reading shows a value and the other reading shows "**OL**", the diode is good.
 - If both readings show "**OL**", the device is open.
 - If both readings are very small or 0, the device is shorted.

Note: The value indicated in the display during the diode check is the forward voltage.

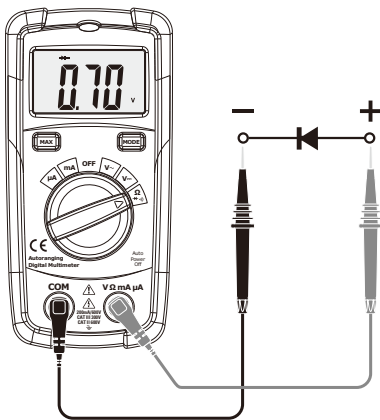

5.Replacing the Battery

WARNING: To avoid electric shock, disconnect the test leads from any source of voltage before removing the battery door.

- When the batteries become exhausted or drop below the operating voltage, “” will appear in the right-hand side of the LCD display, the battery should be replaced.
- Follow instructions for installing battery.
- Dispose of the old battery properly.

- 1.Disconnect the test leads from the meter.
- 2.Open the battery door by loosening the screw using a Phillips head screwdriver.
- 3.Insert the battery into battery holder, observing the correct polarity.
- 4.Put the battery door back in place. Secure with the two screws.

WARNING: To avoid electric shock, do not operate the meter until the battery door is in place and fastened securely.

Note: If your meter does not work properly, check the fuses and battery to make sure that they are still good and that they are properly inserted.

6.Replacing the Fuses

WARNING: To avoid electric shock, disconnect the test leads from any source of voltage before removing the fuse door.

- 1.Disconnect the test leads from the meter and any item under test.
- 2.Open the fuse door by loosening the screw on the door using a Phillips head screwdriver.
- 3.Remove the old fuse from its holder by gently pulling it out.
- 4.Install the new fuse into the holder.
- 5.Always use a fuse of the proper size and value (0.2A/600V fast blow for the 200mA range),
- 6.Put the fuse door back in place. Insert the screw and tighten it securely.

WARNING: To avoid electric shock, do not operate your meter until the fuse door is in place and fastened securely.

7. Specifications

7-1. Technical Specifications

Function	Range	Resolution	Accuracy
DC Voltage	200.0mV	0.1mV	±(0.5% + 4 digits)
	2.000V	1mV	
	20.00V	10mV	±(1.2% + 5 digits)
	200.0V	100mV	
	600V	1V	±(1.5% + 5 digits)

Input Impedance: 10M Ω

Maximum Input: 600V AC/DC rms

AC Voltage (50 to 60Hz)	2.000V	1mV	±(1.2% + 4 digits)
	20.00V	10mV	±(1.5% + 3 digits)
	200.0V	100mV	
	600V	1V	±(2.0% + 4 digits)

Input Impedance: 10M Ω

Maximum Input: 600V AC/DC rms.

DC Current	200.0 μ A	0.1 μ A	±(1.0% + 3 digits)
	2000 μ A	1 μ A	±(1.5% + 3 digits)
	20.00mA	10 μ A	
	200.0mA	100 μ A	

Overload Protection: 0.2A/600V

Maximum Input: 200mA DC or 200mA AC rms on μ A/mA ranges.

AC Current	200.0 μ A	0.1 μ A	±(1.5% + 3 digits)
	2000 μ A	1 μ A	±(1.8% + 3 digits)
	20.00mA	10 μ A	
	200.0mA	100 μ A	

Overload Protection: 0.2A/600V

Maximum Input: 200mA DC or 200mA AC rms on μ A/mA ranges.

Function	Range	Resolution	Accuracy
Resistance	200.0 Ω	0.1 Ω	$\pm(1.5\% + 4 \text{ digits})$
	2.000k Ω	1 Ω	$\pm(1.2\% + 2 \text{ digits})$
	20.00k Ω	10 Ω	$\pm(1.5\% + 2 \text{ digits})$
	200.0k Ω	100 Ω	
	2.000M Ω	1k Ω	$\pm(2.0\% + 3 \text{ digits})$
	20.00M Ω	10k Ω	

Input Protection: 250V dc or 250V ac rms.

Function	Test Current	Resolution	Accuracy
Diode Test	0.3mA typical	1mV	$\pm(1.0\% + 5 \text{ digits})$

Open circuit voltage: 1.5V dc typical

Overload protection: 250V AC/DC rms.

Audible	Audible threshold: Less than 100 Ω Test current: <0.3mA		
Continuity	Overload protection: 250V AC/DC rms.		

Accuracy is given at 18 to 28 $^{\circ}$ C (65 to 83 $^{\circ}$ F), less than 70%RH.

7-2. General Specifications

The Instrument Complies With	EN61010-1
Insulation	Class 2, Double insulation
Overvoltage Category	CAT III 300V / CAT II 600V
Display	2000 count LCD display with function indication.
Polarity	Automatic, (-) negative polarity indication.
Overrange	"OL" mark indication.
Low Battery Indication	The "  " is displayed when the battery voltage drops below the operating level.
Measurement Rate	2 times per second, nominal.
Auto Power Off	Meter automatically shuts down after approx. 15 minutes of inactivity.
Operating Environment	0 to 50°C (32 to 122°F) at <70% relative humidity.
Storage Temperature	-20 to 60°C (-4 to 140°F) at <80% relative humidity.
Max Height	2000m
Pollution Degree	2
Power	One 12V battery
Dimensions (H x W x D)	108 x 53 x 32mm
Weight	Approx. 102g

Distributed by:
Electus Distribution Pty. Ltd.
320 Victoria Rd, Rydalmere
NSW 2116 Australia

www.electusdistribution.com.au

Made in China

