

Roof Mount Installation Manual

Installation Tools

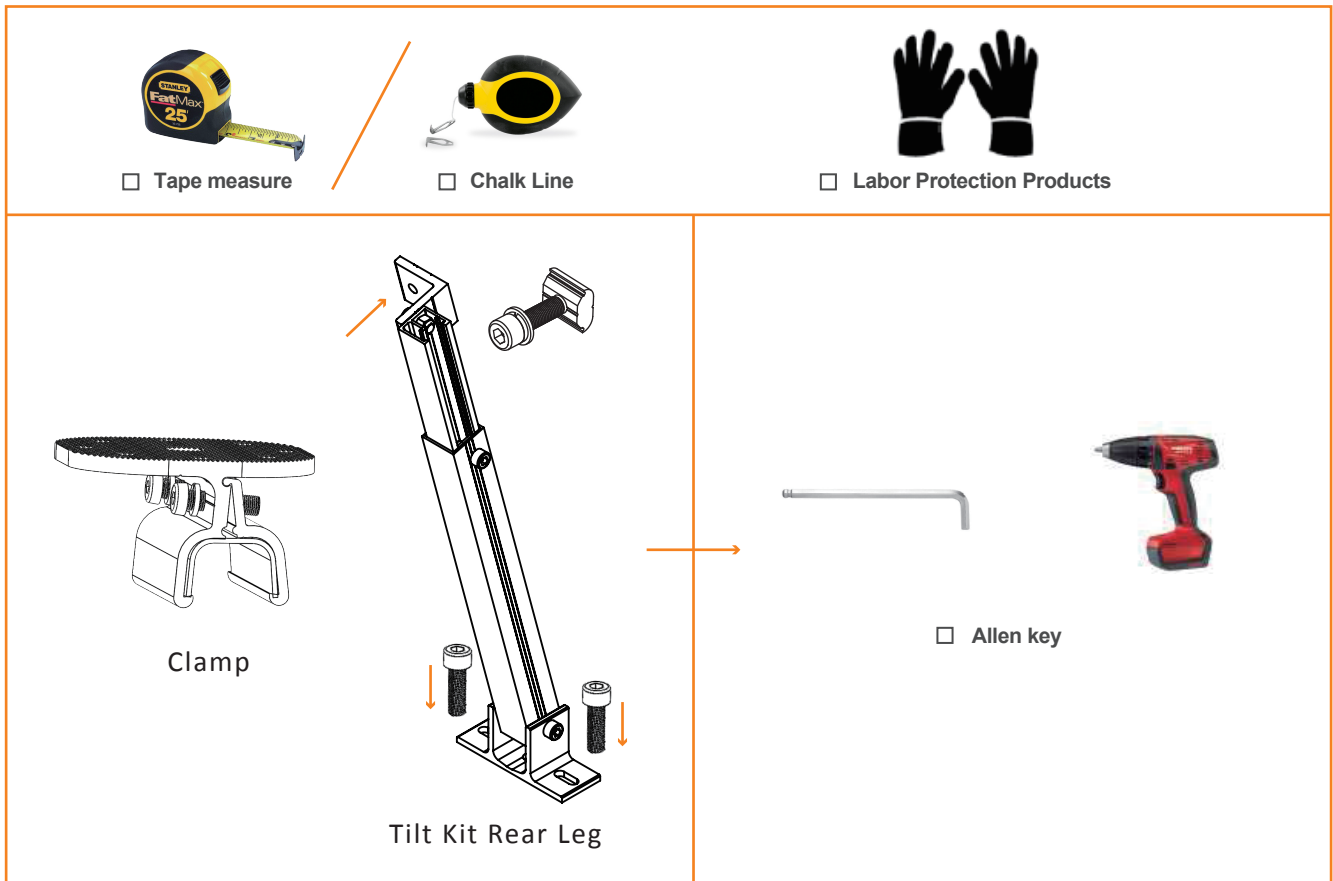

Installation Rule

Installation of the framing shall conform to relevant local government standards, manufacturer's specifications and good building practice. The roof to which the panels are to be installed shall conform to the relevant local government standards.

- Follow the risk management process prior to commencing work – that is, identify all the hazards, assess their risks and eliminate or control them.
- Consult with those involved in the work.
- Develop safe work procedures for installing solar panels, using information from the risk management process, which would include reviewing the following information:
 - Provide appropriate information and training to anyone involved in performing the work.
 - Provide appropriate tools and personal protective equipment (PPE).
 - Ensure that a system is in place to prevent or arrest falls.
 - Ensure there are adequate first aid facilities.
 - Ensure all employees are aware of the emergency procedures.

Tilt Kit Rear Leg

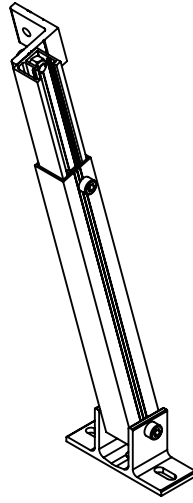

INSTALLATION GUIDE

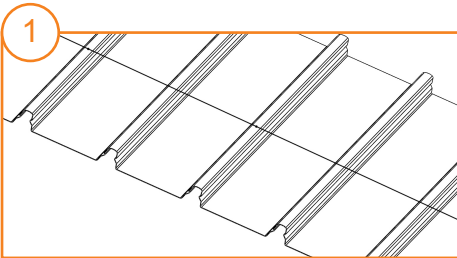

1 Determine where the roof mounts will be positioned and use a tape measure or chalk line to mark the roof.

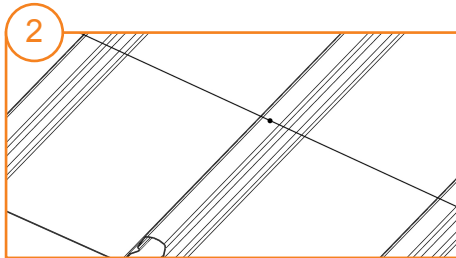

2 Determine the positions where the tilt kit rear leg will be attached on the roof rib and mark the positioned points.

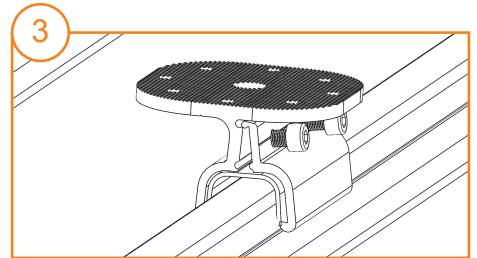

3 Place the clamp onto the roof rib by slightly loosening the bolts of the pre-assembled clamp.

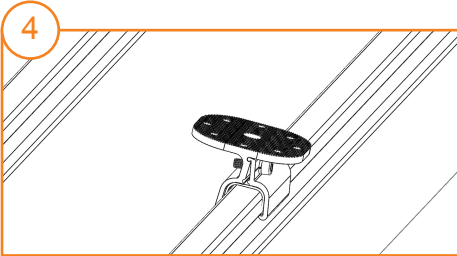

4 Secure the clamp by fastening the two M8*25 inner hex bolts.

M8: tighten torque is 15N.m; safe torque is 20N.m;

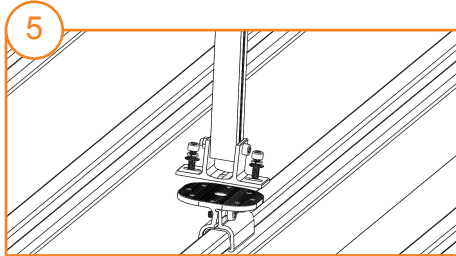

5 Put the leg base onto clamp, and connect them by two M8*25 bolts.

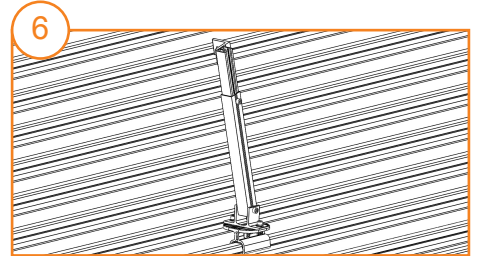

6 Fasten the M8*25 inner hex bolts to secure the rear leg.

M8: tighten torque is 15N.m; safe torque is 20N.m;

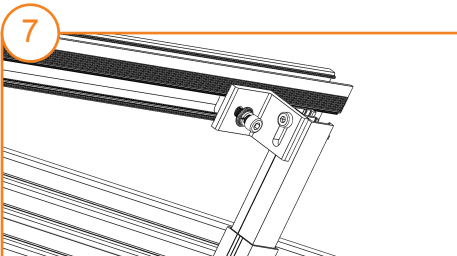

7 Loosely install a M8*25 bolt and a rail nut to the leg connector and tilt the nut into rail groove.

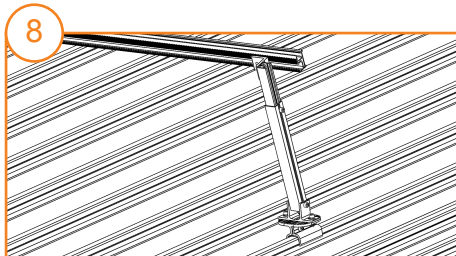

8 Fasten the M8*25 inner hex bolt to connect the rail and rear leg.

M8: tighten torque is 15N.m; safe torque is 20N.m;